



Exclusive Pasternack Distributor:

**MRC GIGACOMP**  
specialists in RF

**MRC GIGACOMP GMBH & CO. KG**

TEL: +49 89 4161 5994 0

FAX: +49 89 4161 5994 5

EMAIL: [info@mrc-gigacom.com](mailto:info@mrc-gigacom.com)

WEB: [www.mrc-gigacom.com](http://www.mrc-gigacom.com)

# 2021 RF Product Guide



Same-Day Shipping | Largest Selection | Expert Technical Support



## With Over 45 Years of RF Expertise, It's More Than Parts That Sets Us Apart

Since 1972, Pasternack has been satisfying the urgent requirements of engineers around the world by offering the largest in-stock, ready-to-ship selection of RF, microwave, and mmWave components, assemblies and devices, including over 40,000 popular and hard-to-find items across 107 categories of interconnect, passives, actives, antennas, and test and measurement. Ranging from DC to 220 GHz maximum frequency levels, Pasternack components are used in a wide range of test, development and deployment environments for military/aerospace, telecom, commercial, and industrial applications.

- 99.4% in-stock availability
- Same-day shipping
- No minimum order quantity
- 24/7 assistance by phone, email or chat
- Engineers on-hand to answer questions
- International distribution partner network

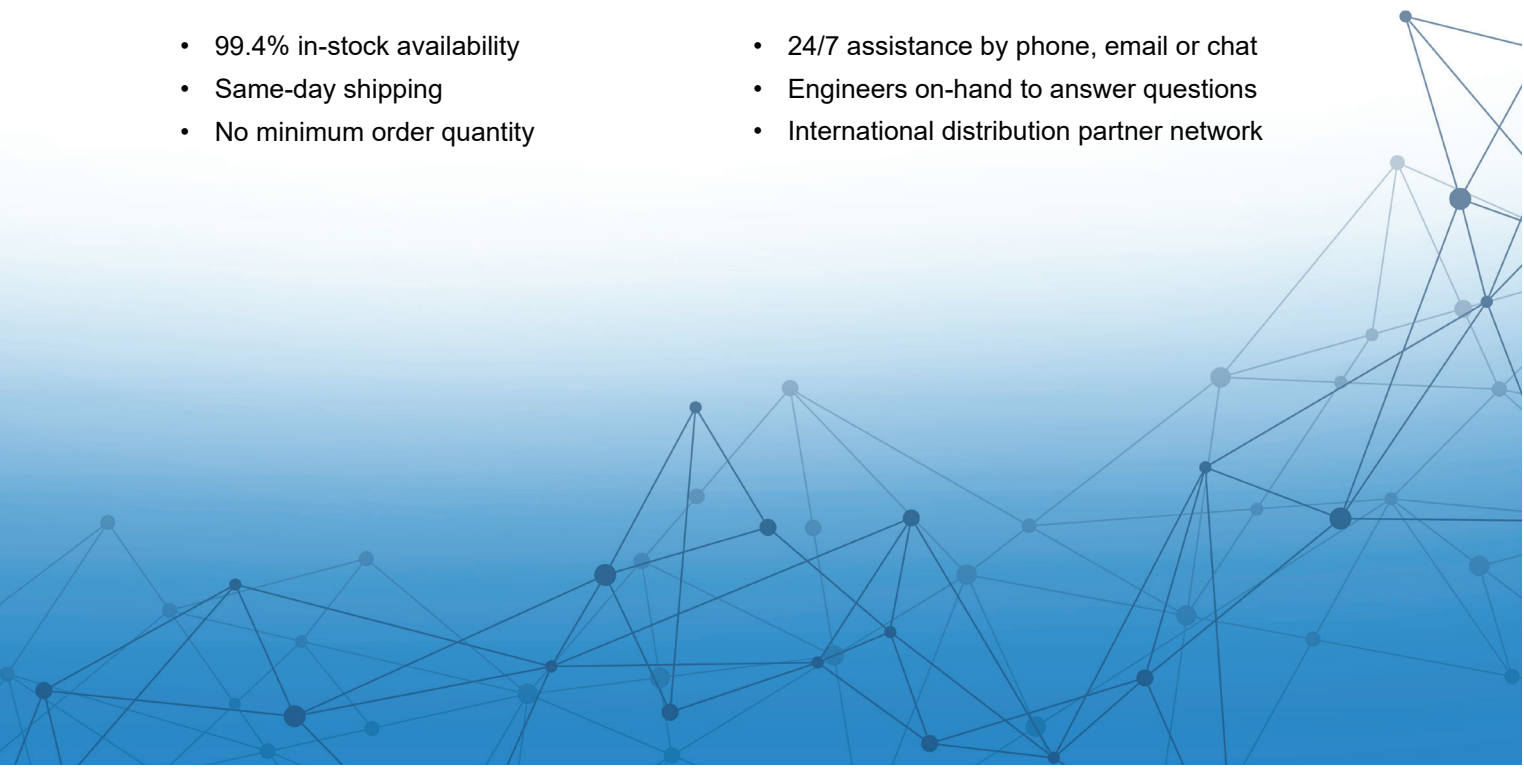

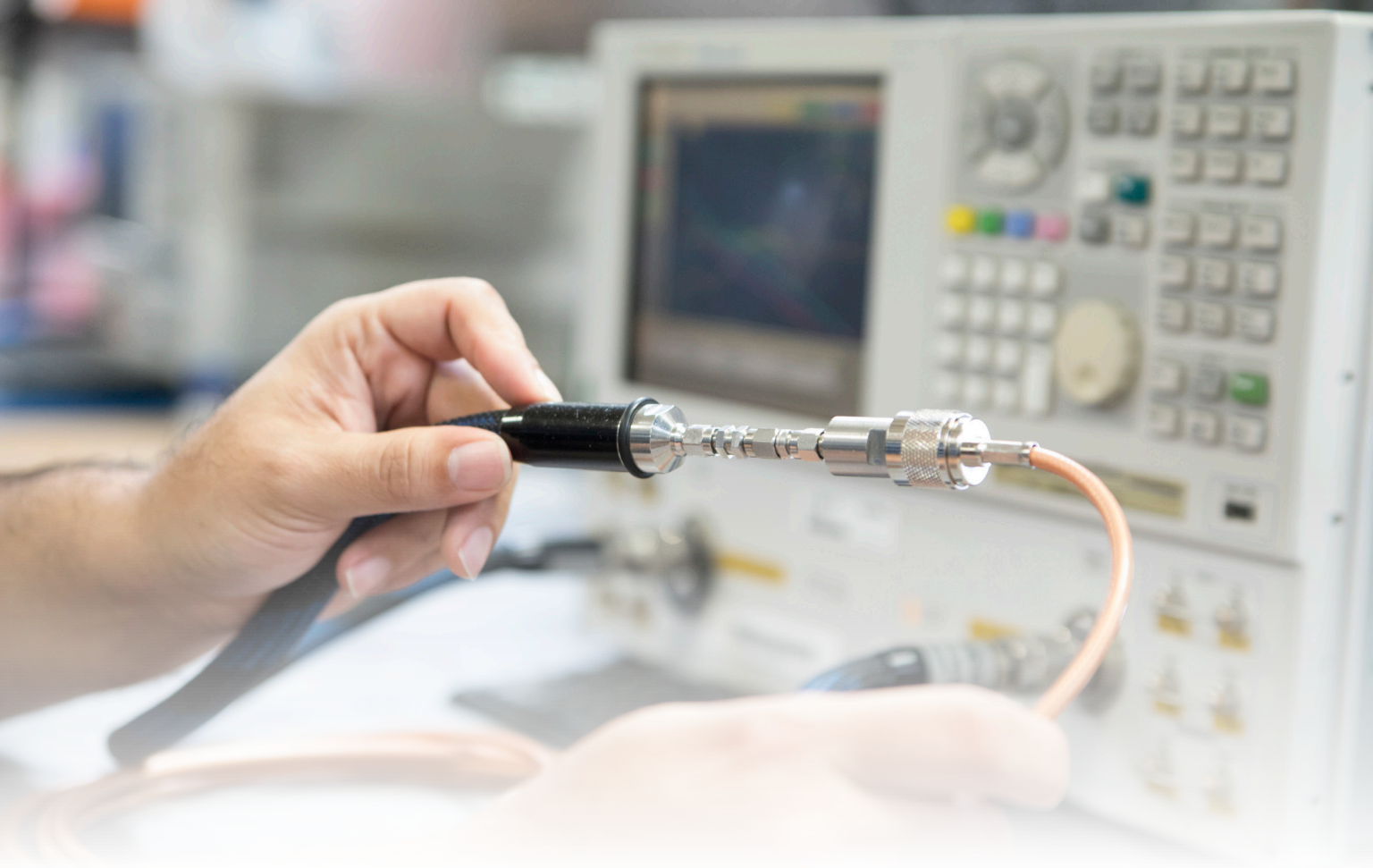

## Largest RF Selection Available for Same-Day Shipping

- Adapters
- Amplifiers
- Antennas
- Attenuators/Equalizers
- Baluns
- Bias Tees/DC Blocks
- Cable Assemblies
- Cables
- Connectors
- Connector Accessories
- Couplers
- Educational Products
- Filters
- Frequency Multipliers/Dividers
- Impedance Matching
- Isolators/Circulators
- Limiters/Detectors
- Mixers/Modulators
- Noise Sources
- Oscillators/Synthesizers
- Phase Shifters/Trimmers
- Power Dividers/Combiners
- Rotary Joints
- Surge Protectors
- Switches
- Terminations
- Test and Measurement
- Tools
- Waveguides
- 60 GHz Systems & Modules



# Expanded Portfolio of High Frequency Components

## In Stock and Available for Same-Day Shipping!

Pasternack's RF Engineering team has curated a broad portfolio of microwave and millimeter wave components to address the needs of 5G innovation and testing, along with other applications requiring higher frequencies and greater bandwidth. Whether your high frequency requirements are for active, passive, or interconnect products, Pasternack has you covered with the industry's largest in-stock selection available for same-day shipping.

### Waveguide Components to 220 GHz

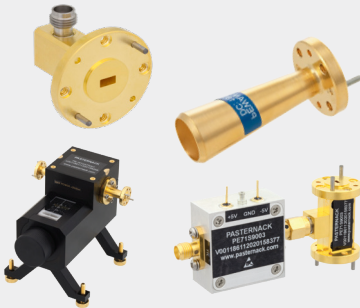

### Electromechanical Switches to 50 GHz

### Waveguide Electromechanical Switches to 40 GHz



### Test Cables and Adapters 2.92mm/40 GHz, 2.4mm/50 GHz 1.85mm/70 GHz, 1.0mm/110 GHz



### Broadband Amplifiers to 86.5 GHz



### Mixers and Detectors to 110 GHz



### PIN Diode Switches to 67 GHz



### High Frequency Power Dividers/ Couplers to 67 GHz



### Calibrated Noise Sources to 60 GHz



### High Band 5G 28 GHz and 39 GHz



# RF PRODUCT GUIDE INDEX

High-Performance Hybrid Couplers; Bi-Phase Modulators; Positive Slope Equalizers; Fixed Load VNA Calibration Kits; Vehicular Antennas, GPS Timing Antennas and Portable UHF Antenna; Waveguide Shorts and Shims; Double Ridge Waveguide Electromechanical Relay Switches; High-Performance Waveguide Antennas, etc.	<a href="#">3</a>	<b>NEW PRODUCT ADDITIONS</b>
60 GHz Development System; 60 GHz Receiver and Transmitter Modules; Radar Development Kit; WR-15 Gain Horn Antennas; 60 GHz Accessories	<a href="#">5</a>	<b>EDUCATIONAL PRODUCTS</b>
Adapter Selection Guide; Adapter Locator (Part Number Identifier); Low PIM Adapters, Adapters to all Connectors	<a href="#">7</a>	<b>ADAPTERS</b>
Amplifiers Selection Guide; Bi-Directional Amplifiers; Broadband Amplifiers; DC Coupled Amplifiers; Gain Block Amplifiers; Limiting Amplifiers; Linear Amplifiers; Log Amplifiers; Low Noise Amplifiers; Power-GaN Amplifiers; Rackmount Variable Gain Amplifiers; Amplifiers Accessories	<a href="#">46</a>	<b>AMPLIFIERS</b>
Directional Antennas; Omni Directional Antennas; Antenna Mounts	<a href="#">57</a>	<b>ANTENNAS</b>
Attenuators Selection Guide; Continuously Variable Attenuators; DC Bias Attenuators; Fixed Attenuators; Step Attenuators; TTL, CMOS, Relay and USB Attenuators; Voltage Variable Attenuators; Positive Slope Equalizers	<a href="#">64</a>	<b>ATTENUATORS &amp; EQUALIZERS</b>
Baluns	<a href="#">83</a>	<b>BALUNS</b>
Bias Tees; DC Blocks	<a href="#">83</a>	<b>BIAS TEES &amp; DC BLOCKS</b>
Cable Assemblies Selection Guide; Cable Assemblies Locator (By Connector Type); High Reliability and Low PIM Cable Assemblies, Precision and Standard Cable Assemblies	<a href="#">85</a>	<b>CABLE ASSEMBLIES</b>
Circulators; Isolators	<a href="#">190</a>	<b>CIRCULATORS &amp; ISOLATORS</b>
75 Ohm Broadcast; Communications; High Performance; RG MIL-C-17 Type Cables; Semi-Rigid & Formable; Twinax	<a href="#">193</a>	<b>COAX CABLES</b>
Connector Selection Guide; Connector Locator (By Connector Type); All Connectors; Non-Shorting Caps; Shorting Caps	<a href="#">199</a>	<b>CONNECTORS</b>
Dual Directional Couplers; Single Directional Couplers; 90 Degree and 180 Degrees Hybrids	<a href="#">268</a>	<b>COUPLERS &amp; HYBRIDS</b>
RF Diplexers	<a href="#">273</a>	<b>RF DIPLEXERS</b>
Bandpass Filters; Highpass Filters; Lowpass Filters; Band Pass Filters; Band Reject Filters; Harmonic Filters	<a href="#">274</a>	<b>FILTERS</b>
Mixers and Bi-Phase Modulators; Frequency Dividers; Frequency Multipliers	<a href="#">276</a>	<b>FREQ. CONVERSION COMPONENTS</b>
Hi-REL Limiters; PIN-PIN Limiters; PIN-Schottky Limiters; Biased Detectors, Finline Detectors, Log Detectors; Phase Detectors, Power Detectors; Schottky Zero Bias Detectors; Threshold Detectors; Tunnel Diode Zero Bias Detectors	<a href="#">279</a>	<b>LIMITERS &amp; DETECTORS</b>
Precision and Standard Noise Sources	<a href="#">282</a>	<b>NOISE SOURCES</b>
Adjustable Phase Shifters and Trimmers; 8 Bit Programmable Phase Shifters; Analog Phase Shifters	<a href="#">283</a>	<b>PHASE SHIFTERS/ TRIMMERS</b>
Resistive and Reactive Power Dividers; Wilkinson Power Dividers; Broadband	<a href="#">283</a>	<b>POWER DIVIDERS &amp; RF COMBINERS</b>
Rotary Joints	<a href="#">286</a>	<b>ROTARY JOINTS</b>
In-Line Surge Protectors; Replacement Cartridges	<a href="#">287</a>	<b>SURGE PROTECTORS</b>
Electromechanical Relay Switches; SMT Packaged Electromechanical Relay Switches; Manual Switches; High Isolation USB Switches; High Isolation Switches; PIN Diode Switches GaN High Power Switches	<a href="#">288</a>	<b>SWITCHES</b>
Synthesizers; Commercial Surface Mount Packaged VCO; Hermetically Sealed MIL Grade Surface Mount Packaged VCO; Connectorized Packaged VCO, Reference Oscillators, TCXO Oscillators, Phase Locked Oscillators and Phase Locked Crystal Oscillators	<a href="#">300</a>	<b>SYNTHESIZERS &amp; OSCILLATORS</b>
Equal Split; Unequal Split	<a href="#">305</a>	<b>TAPPERS</b>
RF Load Terminations; Feed-Thru Load Terminations; Resistive Impedance Transformers	<a href="#">306</a>	<b>TERMINATIONS &amp; MATCHING PADS</b>
1.0mm Flexible VNA Test Cables; 26.5, 40, 50, 67 GHz and 75 Ohm Test Cables; Calibration Kits; Handheld RF Analyzer Rugged Stable Cable Assemblies; PE-TC151 and PE-TC195 Series Phase Stable Test Cable Assemblies; Semi-Rigid Pigtail Test Probes; VNA Test Cable Assemblies, etc.	<a href="#">312</a>	<b>TEST &amp; MEASUREMENT PRODUCTS</b>
Cable Cutters; Crimp Tools; Crimp Tool Dies ; Insertion/Extraction Tools; Torque Wrenches	<a href="#">319</a>	<b>TOOLS</b>
WG Antennas; WG Bandpass Filters; WG Bends; WG Bulkhead Adapters; WG Converters; WG Couplers; WG Detectors; WG Direct Read Atten.; WG EMS; Flexible WG; WG Gunn Oscillators; WG Magic Tees; WG Phase Shifters; WG PIN Diode Switches; WG Power Amps., etc.	<a href="#">322</a>	<b>WAVEGUIDES</b>
Pasternack REACH and RoHS Compliance Programs; Mailing List Changes; Binding Terms/Warranty; Part Number Index; Mounting Holes; Connector Identifiers; Connector Frequency Range Chart; Conversion Tables	<a href="#">350</a>	<b>APPENDIX</b>

The information contained in this catalog and on pasternack.com is accurate to the best of our knowledge at the time of publication. It may be necessary to make modifications to the parts and/or the documentation of the parts, in order to implement improvements. Pasternack reserves



**Technical Support**  
+1 (949) 261-1920



**Same-Day Shipping,**  
Even Custom  
Cable Assemblies

# TABLE OF CONTENTS

<b>Educational Products</b>			
60 GHz Development System	5		
60 GHz Modules	5		
Radar Development Kit	6		
Waveguide Accessories	6		
Waveguide Gain Horns	6		
<b>Adapters</b>			
Adapters to All Connectors	16		
Locator (Part Number Identifier)	8		
Low PIM Adapters	14		
Quick Reference Guide	7		
Selection Guide	7		
<b>Amplifiers</b>			
Locator	46		
Quick Reference Guide	46		
Selection Guide	46		
Amplifier Accessories	56		
Bi Directional Amplifiers	48		
Broadband Amplifiers	48		
DC Coupled Amplifiers	50		
Gain Block Amplifiers	50		
GaN High Power Amplifiers	55		
Input Protected Low Noise Amplifiers	52		
Limiting Amplifiers	50		
Log Amplifiers	51		
Low Noise Amplifiers	51		
Power Amplifiers	53		
Variable Gain Amplifiers	56		
<b>Antennas</b>			
Antenna Mounts	63		
Directional Antennas	57		
Omni Directional Antennas	59		
<b>Attenuators, Active</b>			
Locator	64		
Quick Reference Guide	64		
Selection Guide	64		
Programmable Attenuators	81		
Voltage Variable Attenuators	82		
<b>Attenuators, Passive</b>			
Locator	64		
Quick Reference Guide	64		
Selection Guide	64		
Continuously Variable Attenuators	81		
DC Bias Attenuators	81		
Fixed Attenuators	66		
Step Attenuators, Push Button	79		
Step Attenuators, Rotary	80		
Step Attenuators, Toggle	80		
<b>Baluns</b>			
Surface Mount	83		
<b>Bias Tee</b>			
Bias Tee	83		
<b>Cable Assemblies</b>			
Locator (By connector Type)	86		
Low PIM and High-Reliability Cable Assemblies	90		
Precision and Standard Cable Assemblies	94		
Quick Reference Guide	85		
Selection Guide	85		
<b>Circulators</b>			
2.92mm Connectors	190		
N Connectors	190		
SMA Connectors	190		
<b>Coaxial Cables</b>			
75 Ohm Broadcast	194		
Communications	194		
High Performance	195		
RG Mil-C-17 Type Cable	196		
Semirigid and Formable	197		
Twinax Cable	198		
<b>Connectors</b>			
Locator (Part Number Identifier)	199		
Quick Reference Guide	199		
Selection Guide	199		
<b>Connector Caps</b>			
Non-Shorting Caps	267		
Shorting Caps	267		
<b>Couplers</b>			
90 degree Hybrid	272		
180 degree Hybrid	273		
Directional	268		
Dual Directional	271		
<b>DC Blocks</b>			
1.85mm	84		
2.4mm	84		
2.92mm	84		
BNC	84		
N	84		
SMA	84		
TNC	84		
BNC	84		
F	84		
N	84		
<b>Detectors</b>			
Biased Detectors	280		
Finline Detectors	280		
Log Detectors	280		
Phase Detectors	280		
Power Detectors	281		
Schottky Zero Bias Detectors	281		
Threshold Detectors	281		
Tunnel Diode Zero Bias Detectors	281		
<b>RF Diplexers</b>			
Low Pass and High Pass	273		
<b>Equalizers</b>			
Positive Slope Equalizers	82		
<b>Filters</b>			
Band Pass	276		
Band Reject	276		
Chebyshev Filters	275		
Combine Filters	274		
Filters	274		
High Pass Filters	275		
Low Pass Filters	275		
<b>Frequency Dividers</b>			
SMA Connectors	276		
<b>Frequency Multipliers</b>			
Active	278		
Passive	278		
<b>Isolators</b>			
2.4mm Connectors	191		
2.92mm Connectors	191		
N Connectors	191		
SMA Connectors	191		
<b>Limiters</b>			
HIGH REL	279		
PIN-PIN	279		
PIN-Schottky	279		
<b>Manual Switches</b>			
Manual Switches	295		
<b>Matching Pads</b>			
Resistive Impedance Transformers	311		
<b>Mixers</b>			
Double Balanced	277		
IQ	277		
Triple Balanced	277		
<b>Modulators</b>			
BiPhase	278		
<b>Noise Sources</b>			
Precision	282		
Standard	282		
<b>Oscillators</b>			
0.175" Ultra Small Commercial Surface Mount Packaged VCO	301		
0.5" Commercial Surface Mount Packaged VCO	301		
0.5" Commercial Surface Mount Packaged VCO w/ Integrated Buffer Amps	302		
0.5" Commercial Surface Mount Packaged VCO w/ Low Noise	302		
0.5" Commercial Surface Mount Packaged VCO w/ Modulation Input Port	302		
0.5" Hermetically Sealed MIL Grade Surface Mount Packaged VCO	302		
Connectorized Packaged VCO w/ Field Replaceable Connectors	303		
Phase Locked Crystal Oscillators	304		
Phase Locked Oscillators	304		
Reference Oscillators	303		
TCXO Reference Oscillators	304		
<b>Phase Shifters</b>			
8 Bit Programmable Phase Shifter	283		
Adjustable Phase Shifter	283		
Analog Phase Shifter	283		
<b>Phase Trimmers</b>			
Adjustable Phase Trimmer	283		
<b>Power Dividers</b>			
	283		
Reactive	284		
Resistive	284		
Wilkinson	285		
<b>RF Combiners</b>			
Broadband	286		
<b>Rotary Joints</b>			
2.92mm	286		
SMA-PCB	286		
<b>Surge Protectors</b>			
In-Line Surge Protectors	287		
Surge Protector Replacement Cartridges	287		
<b>Switches</b>			
Electromechanical Relay Switches	288		
Electromechanical Relay Switches, SMT Packaged	294		
GaN High Power Switches	299		
High Isolation PIN Diode Switches	299		
High Isolation USB PIN Diode Switches	299		
PIN Diode Switches	295		
<b>Synthesizers</b>			
Integer/Fractional	300		
<b>Tappers</b>			
Equal Split	305		
Unequal Split	305		
<b>Terminations</b>			
Feed-Thru Load	310		
RF Load	307		
<b>Test And Measurement</b>			
1.0mm Flexible VNA 110 GHz Precision Cables	316		
26.5 GHz and 40 GHz Test Cables	318		
40 GHz Skew Matched Cable Pairs	314		
4-in-1 Calibration Kits	313		
50 GHz and 67 GHz Test Cable Assemblies	315		
75 Ohm Test Cable Assemblies	318		
Bench Type Calibration Kits	312		
Handheld RF Analyzer Rugged Phase Stable Cable Assemblies	314		
Interchangeable Connectors	313		
PE-TC151 Series Phase Stable Test Cable	317		
PE-TC195 Series Phase Stable Test Cable	317		
RF Microwave Probes	313		
Semi-Rigid Pigtail Test Probes	318		
VNA Ruggedized Test Cable	315		
<b>Tools</b>			
Cable Cutter	319		
Crimp Tool Dies	321		
Crimp Tools	321		
Insertion/Extraction Tool	319		
Torque Wrenches	320		
<b>Waveguides</b>			
Double Ridge Waveguide Electromechanical Relay Switches	341		
Flexible Waveguides	341		
Waveguide Accessories	348		
Waveguide Antennas	324		
Waveguide Antennas Accessories	329		
Waveguide BandPass Filters	332		
Waveguide Bends	332		
Waveguide Bulkhead Adapters	333		
Waveguide Converter Mixers	333		
Waveguide Couplers	334		
Waveguide Couplers Assemblies	336		
Waveguide Detectors	339		
Waveguide Direct Read Attenuators	340		
Waveguide Electromechanical Relay Switches	340		
Waveguide Isolators	342		
Waveguide Low Noise Amplifiers	343		
Waveguide Magic Tees	343		
Waveguide Orthomode Transducers	343		
Waveguide Phase Shifters	343		
Waveguide PIN Diode Switches	344		
Waveguide Polarizers	344		
Waveguide Power Amplifiers	344		
Waveguide Sections	345		
Waveguide Terminations	346		
Waveguide Transitions	347		
Waveguide Twists	348		
Waveguide Variable Attenuators	348		

## HELPFUL RESOURCES

Connector Freq. Range Chart	374	Mounting Hole Layout	369
Connector Identifier	370	Part Number Index	355
Conversion Tables	367	REACH-RoHS Compliance Program	351
How to Place your Order	352	Terms & Conditions	352

# NEW PRODUCT ADDITIONS

## High-Performance Hybrid Couplers (See pages [272](#), [273](#))



- High operating frequency range up to 40GHz for wide band applications
- Coaxial designs with SMA and 2.92mm connectors
- Output phase shifts of 90 degree and 180 degree available
- Power handling capability up to 100W(CW)
- Very good isolation and insertion loss performances with low

- return loss
- Flat phase balance performance across frequency range

## Bi-Phase Modulators Operating in Frequency Bands from 0.5 to 40 GHz (See pages [278](#))



- Broadband frequency coverage from 500 MHz to 40 GHz
- Comprehensive selection of 9 models offered
- TTL level digital bit stream is encoded onto the RF carrier
- 2 Phase Shift Keying (2PSK) modulation at 180° and 0°
- Low insertion loss: 2.5 dB typical

- Compact packaging with SMA or 2.92mm RF female connectors
- High peak input power handling up to 0.5 watts

## Positive Slope Equalizers (See pages [82-83](#))



- Broadband frequency coverage from 500 MHz to 40 GHz
- Comprehensive selection of 18 models offered
- Fixed positive slope equalizing values ranging from 2 dB to 8 dB
- Low insertion loss ranging from 1 dB to 3 dB

- Compact packaging with field replaceable RF connectors
- High CW input power handling up to +30 dBm

## Fixed Load VNA Calibration Kits (See pages [312](#))



- Include all necessary components to perform highly accurate 1 port to 4 port calibration of VNAs
- Offer components for short open load calibration technique -or- short open load and thru method
- 7 connector series including:
  - 2.4mm, 50 GHz SOL, SOLT;

- 2.92mm, 40 GHz, SOL, SOLT;
- 3.5mm, 26.5 GHz, SOL, SOLT;
- 7/16 DIN, 7.5 GHz, SOL, SOLT;
- 7mm, 18 GHz, SOLT;
- BNC, 10 GHz, SOLT;
- N-Type, 18 GHz, SOL, SOLT

## Vehicular Antennas, GPS Timing Antennas and Portable UHF Antenna (See pages [60](#), [62](#), [63](#))



- Broad selection of vehicular antennas and antenna kits
- 108 MHz – 2.7 GHz operating frequencies, 0-32 dBi
- Ideally suited for multi-point mobile applications, including service vehicles, public transportation, public safety, mining, construction, and other mobile, wide-coverage applications

## Waveguide Shorts and Shims in WR-430 to WR-10 Waveguide Sizes (See pages [348-349](#))



- Frequency ranges from 1.72 GHz to 110 GHz in 18 waveguide bands
- Waveguide sizes from WR-10 to WR-430
- Parts made with high-precision machining in aluminum or brass
- Large product selection available

## Double Ridge Waveguide Electromechanical Relay Switches (See pages [341](#))



- Comprehensive selection of 12 double ridge WG EMS models
- Broadband multi-octave frequency: 6.5 GHz to 40 GHz
- SPDT and optional DPDT configurations with latching self cut-off actuators, TTL logic, and position indicators with manual override

- Power handling capability up to 8.5 kW CW
- Designs support WRD-650, WRD-750, and WRD-180 waveguide sizes
- Patented motor drive with arc suppression
- Environmentally sealed quick connect DC control connector & mate included

## High-Performance Waveguide Antennas (See pages [327-328](#), [331-332](#))



- Complete line of high-performance waveguide antennas, with operating frequencies from 1.7 to 220 GHz
- Ideal for applications such as: Antenna Measurements, Laboratory Use, Wireless Communications, Microwave Radio Systems



Technical Support  
+1 (949) 261-1920



Same-Day Shipping,  
Even Custom  
Cable Assemblies

# NEW PRODUCT ADDITIONS

## High Frequency Waveguide Components for Transmission Lines (See pages [332-333](#), [345-346](#), [348](#))



- High frequency ranges from 90 GHz to 220 GHz in 3 waveguide bands
- Waveguide sizes: WR-8, WR-6 and WR-5
- UG-387/U mod round cover style flange
- Large product selection available

## New Class AB High Power Amplifiers with Optional Heatsinks (See pages [53](#), [56](#))



- 18 new class AB broadband power amplifiers support popular octave bands ranging from 20 MHz to 18 GHz
- GaN, LDMOS, and VDMOS designs feature high linearity and efficiency with low distortion over a wide dynamic range
- Saturated output power levels ranging from 10 watts to 200 watts with up to 40% power added efficiency
- Power gain levels range from 37 dB to 53 dB
- D-Sub control connectors for DC bias, enable with TTL logic control, current and temperature sense functions
- Compact and rugged coaxial packages have optional heatsink with cooling fans available

## Coaxial RF Surge Protectors with 4.3-10 Connectors (See pages [287](#))



- 4.3-10 F/M Bulkhead Coaxial RF Surge Protector
- Frequency Range: 698MHz - 2.7GHz
- Low PIM -173 dBc

## High Power Attenuators with Frequency Coverage of 6 GHz and 18 GHz (See pages [72](#), [75](#))



- Support frequency range from DC up to 18 GHz
- Power handling capability up to 100W(CW)
- Coaxial designs with SMA and N-type connectors
- Flat RF response and performance
- VSWR as low as 1.2:1
- Available with 3 dB to 40 dB attenuation levels

## Frequency Dividers in Rugged and Compact SMA Connectorized Packages (See pages [276](#))



- Comprehensive selection of 28 different prescaler models
- Broadband input frequency coverage from 0.1 GHz to 20 GHz
- Broad selection of divide-by-ratios ranging from 2 to 40
- Input power range from -20 dBm to +15 dBm
- Output power levels range from -6 to +5 dBm
- Low phase noise down to -155 dBc/Hz typical @ 100 kHz offset
- Compact coaxial packaged assemblies guaranteed to meet MIL-STD environmental test conditions

## High Frequency Couplers with Low Insertion Loss and Low Return Loss (See pages [268](#), [270](#))



- Directional couplers with high operating frequency range up to 67 GHz for wide band applications
- Coaxial designs with SMA, 2.92mm, 2.4mm and 1.85mm connectors
- Power handling capability up to 30W(CW)
- Excellent isolation and insertion loss performances with low return loss
- Available with 6dB, 10dB, 15dB, 20dB and 30dB coupling levels

## RF Limiters with Frequencies up to 40 GHz (See pages [279](#))



- Broadband Frequency Coverage from 20 MHz to 40 GHz
- 13 Different Models Offer Comprehensive Performance Features
- CW Input Power Rated up to 5 watts
- Peak Power Handling Capability of 200 Watts
- Flat Leakage Power Ranges from +10 dBm to +18 dBm
- Compact Packages with Field Replaceable Connectors and Thru Mounting Holes
- Models are Designed to Meet MIL-STD-202 Test Conditions

## Aluminum Waveguide-to-Coax Adapters, MIL-DTL-22641 compliant (See pages [329-331](#))



- Aluminum body for reduced weight
- Electrical performance and mechanical dimensions compliant with MIL-DTL-22641
- 14 different waveguide sizes available from WR-42 to WR-430 (Frequency range from 1.7 to 26.5GHz)
- VSWR as low as 1.25:1
- Flange types: UG square/round cover, CMR or CPR
- Available in SMA female, N-type female and 2.92mm female connectorized designs, as well as end launch connector configurations



## EDUCATION PRODUCTS

### 60 GHz Development System



The Pasternack 60 GHz development system provides rapid evaluation of Pasternack's 60 GHz waveguide modules for quick prototyping for millimeter wave wireless system development. This high speed wireless 60 GHz developer kit is created in a partnership between Pasternack and Vubiq (pronounced "View-bik"), an industry expert in designing 60 GHz RF systems. Our 60 GHz wireless development system makes it easy and fast to design new products and applications in the emerging unlicensed millimeter wave ISM V band.

This 60 GHz wireless communications development system facilitates an accelerated design of new high bandwidth products and solutions. This Pasternack 60 GHz development kit utilizes a convenient to use GUI for configuration via USB. A standard WR-15 V-band waveguide antenna interface is incorporated into this millimeter wave system and has a 1.8 GHz modulation bandwidth. 802.11ad and 802.11aj WiFi / WiGig development is supported by the 60 GHz wireless communication system.

60 GHz Development System and Waveguide Modules is a versatile toolkit that allows imagining and designing applications in the readily accessible ISM band. The below list illustrates possible usages of the system and modules:

- High bandwidth data links, supporting multi-gigabit data rates such as gigabit Ethernet data communication
- Wi-Fi, 802.11ad and 802.11aj
- High speed video and audio solutions
- High bandwidth modulation techniques using Quadrature Amplitude Modulation (QAM) and Multiple Input Multiple Output (MIMO)
- High-Definition Serial Digital Interface (HD-SDI) video links
- High resolution radar using Frequency Modulated Continuous Wave (FMCW) modulation
- Building-to-building high speed networks
- High resolution synthetic aperture radar (also using FMCW modulation)
- Remote sensing
- Atmospheric radiometers (receive only) for oxygen and atmospheric research
- Liquid level detection
- Military applications



### 60 GHz Modules

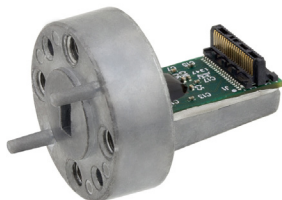

The 60 GHz transmitter and 60 GHz receiver modules open up ultra high speed, high bandwidth data transmission for widespread use. Pasternack 60 GHz waveguide modules utilizes the globally unlicensed millimeter wave spectrum of 57 GHz to 64 GHz. Our wireless 60 GHz waveguide transmitter and receiver components are ideal for meeting the high speed data transmission needs of companies and developers.

These silicon germanium (SiGe) chip based 60 GHz transceiver modules are lower cost and easier to integrate than existing competing products. Pasternack's 60 GHz V band wireless solution is equally effective at a fraction of the cost and can be connected to any off-the-shelf WR-15 waveguide through the UG-385/U flange. Lower cost, ease of use and ability to attach standard components make these 60 GHz Tx and Rx units practical for a wide range of configurations and budgets.

For typical 60 GHz waveguide module applications please refer to the 60 GHz-Development Section above.

Type	Frequency Range (GHz)	Mod. Bw. (GHz)	Gain (dB)	Gain Range (dB)	Input Range P1dB (dBm)	Psat (dBm)	NF (dB)	Input IP3 (dBm)	ECCN	Model No	1 Pc. Price	See Web for Volume Pricing	R O W
Development System	57.0 - 64.8	1.10	both	both	both	15	6	-27	3A001.B.4.F.1	<a href="#">PEM009-KIT</a>	\$13,252.17	See Web for Volume Pricing	1
Transmitter	57.0 - 64.8	1.8	38	20	12	15			3A001.B.4.F.1	<a href="#">PEM010</a>	Call		2
Receiver	57.0 - 64.8	1.8	67	65	-36		6	-27	3A001.B.4.F.1	<a href="#">PEM002-MIM</a>	Call		3
Transmitter Dev. System	57.0 - 64.8	1.1	38	20	12	15			3A001.B.4.F.1	<a href="#">PEM009-KIT-TX</a>	\$8,352.79		4

See Our Website For Current Pricing & Real-Time Stock Availability!



Technical Support  
+1 (949) 261-1920



Same-Day Shipping,  
Even Custom  
Cable Assemblies

## Gain Horn Antennas

Pasternack's high gain WR-15 horn antennas operate between 50 GHz and 70 GHz and are available in 20 dBi, 24 dBi, 34 dBi and 42 dBi gain models. Pasternack's WR-15 waveguide horn antennas pair seamlessly with the recently added 60 GHz transmit/receive development system (PEM003-KIT) which enables companies to experiment and develop applications in the globally-unclassified 60 GHz frequency band. Using two of Pasternack's WR-15 beam antennas rated to 42 dBi gain (PE9881-42), a user is able to transmit and receive a 60 GHz signal at a distance of one kilometer (km), making these antennas an ideal solution for high frequency point-to-point backhaul.

Additionally, Pasternack offers an omni-directional millimeter wave antenna (PE-W15A001), a vertically polarized WR-15 waveguide connected antenna using a standard UG387/U flange that operates between 58 GHz and 63 GHz. This omni-directional millimeter wave antenna has a 30 degree vertical beam width and a 360 degree horizontal gain variation, making it ideal for short range wireless communications, indoor networks, high frequency applications and 60 GHz development systems. The millimeter wave omni-directional antenna is constructed with a durable brass waveguide input and light-weight aluminum body.



Freq. Range (MHz.)	Waveguide Size	Interface Type	Gain	ECCN	Model No	1	2-4	5-9	10+	ROW
50 - 75	WR-15	UG-385/U	20	5A991	<a href="#">PE9881-20</a>	Call	Call	Call	Call	5
			24	5A991	<a href="#">PE9881-24</a>	\$1,479.18	\$1,420.01	\$1,360.85	\$1,301.68	6
			42	5A991	<a href="#">PE9881-42</a>	\$2,366.43	\$2,271.77	\$2,177.12	\$2,082.46	7
56 - 66	WR-15	UG-385/U	34	5A991	<a href="#">PE9881-34</a>	\$1,552.93	\$1,498.58	\$1,444.22	\$1,397.64	8
58 - 63	WR-15	UG-387/U	0	5A991	<a href="#">PE-W15A001</a>	Call	Call	Call	Call	9

## 60 GHz Accessories



Model No	Description	1 Pc. Price	ROW
<a href="#">PEM004</a>	60GHz Baseboard I/Q Module	\$2,191.51	10
<a href="#">PEM005</a>	60 GHz Waveguide Module Flex Circuit Cable	\$651.62	11

## Radar Development Kits



Model No	Description	1	2-4	5-9	10+	ROW
<a href="#">PEM11002-KIT</a>	2.4 GHz to 2.5 GHz ISM Band Radar Demonstration Kit, USB or Bluetooth Control, GUI, Includes Radar Board, Antennas, Cables, and Accessories	\$2,829.26	\$2,716.09	\$2,602.92	\$2,489.75	12
<a href="#">PEM11000-KIT</a>	2.4 GHz to 2.5 GHz ISM Band Radar Demonstration Kit, USB or Bluetooth Control, GUI, Includes Radar Board, Antennas and Cables	\$2,598.30	\$2,494.37	\$2,390.44	\$2,286.50	13

See Our Website For Current Pricing & Real-Time Stock Availability!

# Adapter Selection Guide

## 3 Easy Ways to Find your Product.....

### 1. Search by PE Part Number

If you know the PE part number you are searching for, please reference our Part Number Index on Page [355](#)

### 2. Quick Reference Guide

(Page number refers to first appearance of product in the Adapter Section)

Connector Series	Page	Connector Series	Page	Connector Series	Page	Connector Series	Page	Connector Series	Page
1.0/2.3	<a href="#">33</a>	10-32	<a href="#">22</a>	Banana	<a href="#">45</a>	MHV	<a href="#">23</a>	SC	<a href="#">21</a>
1.0mm	<a href="#">16</a>	75 Ohm BNC	<a href="#">42</a>	BMA	<a href="#">22</a>	Mini SMP	<a href="#">17</a>	SHV	<a href="#">26</a>
1.85mm	<a href="#">16</a>	75 Ohm F	<a href="#">23</a>	BNC	<a href="#">19</a>	Mini UHF	<a href="#">26</a>	SMA	<a href="#">17</a>
2.4mm	<a href="#">16</a>	75 Ohm Mini SMB	<a href="#">43</a>	BNC Triax	<a href="#">23</a>	MMBX	<a href="#">27</a>	SMB	<a href="#">29</a>
2.4mm NMD	<a href="#">17</a>	75 Ohm N	<a href="#">43</a>	C	<a href="#">23</a>	MMCX	<a href="#">26</a>	SMC	<a href="#">29</a>
2.92mm	<a href="#">16</a>	75 Ohm PAL	<a href="#">43</a>	Double Banana Binding Post	<a href="#">23</a>	N	<a href="#">16</a>	SMP	<a href="#">17</a>
2.92mm NMD	<a href="#">42</a>	75 Ohm RCA	<a href="#">23</a>	D-Sub	<a href="#">24</a>	QMA	<a href="#">29</a>	SSMA	<a href="#">18</a>
3.5mm	<a href="#">16</a>	75 Ohm SMB	<a href="#">23</a>	FME	<a href="#">24</a>	Rev Pol BNC	<a href="#">23</a>	SSMB	<a href="#">35</a>
3.5mm NMD	<a href="#">19</a>	75 Ohm SMC	<a href="#">23</a>	GR874	<a href="#">24</a>	Rev Pol MCX	<a href="#">37</a>	SSMC	<a href="#">37</a>
4.1/9.5 Mini DIN	<a href="#">19</a>	75 Ohm TNC	<a href="#">44</a>	HN	<a href="#">21</a>	Rev Pol N	<a href="#">28</a>	TNC	<a href="#">29</a>
4.3-10	<a href="#">14</a>	78 Ohm BNC	<a href="#">45</a>	LC	<a href="#">25</a>	Rev Pol SMA	<a href="#">32</a>	UHF	<a href="#">29</a>
7/16 DIN	<a href="#">20</a>	Twinax		MCX	<a href="#">25</a>	Rev Pol TNC	<a href="#">30</a>	UMCX	<a href="#">35</a>
7mm	<a href="#">17</a>	95 Ohm 3/4"-20 Twinax	<a href="#">45</a>			Rev Thread SMA	<a href="#">33</a>		

## Adapter Locator Layout

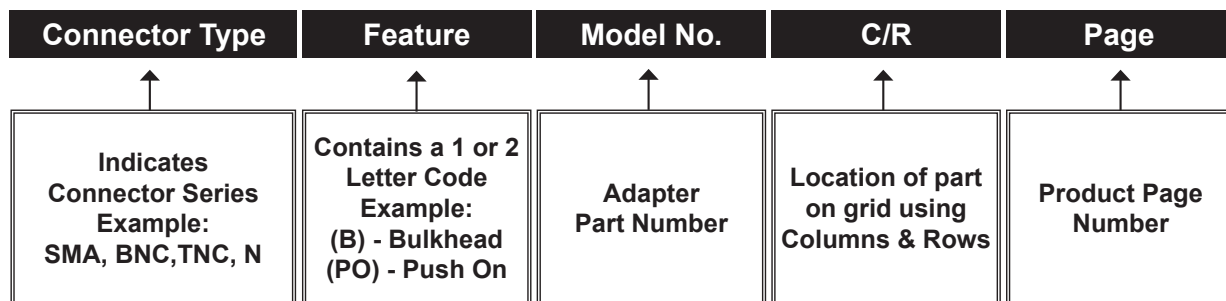

### 3. Between-Series Adapter Locator

(Adapter Locator starts on Page [8](#))



SMA FEMALE TO TNC FEMALE  
PE9079

SMA Female To:		EXAMPLE		
Connector Type	Feature	Model No.	C/R	Page
SSMA Male		PE9188	A4	163
SSMB Plug		PE0402	A3	167
TNC Female		<b>PE9079</b>	D6	164
TNC Female	(B)	PE9251	A1	165

TNC Female To:		EXAMPLE		
Connector Type	Feature	Model No.	C/R	Page
SMA Female	(P)	PE0442	C6	164
SMA Female		<b>PE9079</b>	D6	164
SMA Female	(B)	PE9251	A1	165
SMA Female	(PM)	PE9276	B1	165

The Adapter Locator example above includes Between-Series part numbers in two configurations:

**Connector 1 to Connector 2 as well as Connector 2 to Connector 1 can be found in the same location.**

Products can only be found under the first instance of the series combination. As an example, PE9079 above will be found in only one location in the Adapter Section.

# Adapter Locator

Connector Type	Feature	Model No.	C/R	Page
<b>1.0/2.3 Jack To:</b>				
SMA Female		PE9693	A4	35
SMA Male		PE9690	D4	33
<b>1.0/2.3 Plug To:</b>				
SMA Female		PE9691	E3	35
SMA Male		PE9692	C4	33
<b>1.0mm Female To:</b>				
1.85mm Female		PE91109	D2	16
1.85mm Male		PE91119	C2	16
<b>1.0mm In-Series:</b>				
Female to Female		PE91463	D1	16
Female to Male		PE91461	C1	16
Male to Male		PE91462	B1	16
<b>1.0mm Male To:</b>				
1.85mm Female		PE91108	B2	16
1.85mm Male		PE91118	A2	16
<b>1.85mm Female To:</b>				
1.0mm Female		PE91109	D2	16
1.0mm Male		PE91108	B2	16
2.4mm Female	90°	PE91159	B5	17
2.4mm Male		PE9675	C2	17
2.4mm Female		PE9674	D7	16
2.92mm Female		PE9668	D2	18
2.92mm Male	90°	PE91162	C5	16
2.92mm Male		PE9666	D6	17
3.5mm Female		PE9748	D2	19
3.5mm Male		PE9745	A1	19
N Female		PE9721	E5	16
N Male		PE9720	D5	16
SMA Female		PE9729	C4	35
SMA Male		PE9728	A5	33
<b>1.85mm In-Series:</b>				
Female to Female		PE91084	E3	16
Female to Female		PE91115	A4	16
Male to Female		PE91086	C3	16
Male to Female		PE9715	D3	16
Male to Male		PE91085	A3	16
Male to Male		PE9716	B3	16
<b>1.85mm Male To:</b>				
1.0mm Female		PE91119	C2	16
1.0mm Male		PE91118	A2	16
2.4mm Female		PE9673	B2	17
2.4mm Male		PE9672	C7	16
2.92mm Female		PE9665	C2	18
2.92mm Male	90°	PE91161	C4	16
2.92mm Male		PE9667	O6	17
3.5mm Female		PE9747	D4	16
3.5mm Male		PE9746	E7	18
N Female		PE9719	A5	16
N Male		PE9718	E4	16
SMA Female		PE9726	B4	35
SMA Male		PE9727	E4	33
<b>10-32 Female To:</b>				
BNC Female		PE9752	A6	22
BNC Female	(B)	PE9754	B6	22
BNC Male		PE9750	E5	22
<b>10-32 In-Series:</b>				
Female to Female		PE9756	D4	22
Female to Female	(B)	PE9757	E4	22
<b>10-32 Male To:</b>				
BNC Female		PE9753	C5	22
BNC Female	(B)	PE9755	D5	22
BNC Male		PE9751	B5	22
<b>2.4mm Female To:</b>				
1.85mm Female		PE9675	C2	17
1.85mm Female	90°	PE91159	B5	16
1.85mm Male		PE9673	B2	17
2.4mm NMD Female		PE91145	A4	17
2.92mm Female		PE91295	B3	18
2.92mm Female		PE91499	C3	18
2.92mm Female		PE9456	D3	18
2.92mm Male		PE91450	B7	17
2.92mm Male		PE9455	C7	17
2.92mm Male	90°	PE91144	B5	42
2.92mm Male		PE9455	C7	17
2.92mm NMD Female		PE91144	B5	42
3.5mm Female		PE91291	B3	19
3.5mm Female		PE9652	C3	19
3.5mm Male		PE9651	D1	19
3.5mm NMD Female		PE91148	D4	19
Full Detent Mini SMP Male		PE91122	D2	17
Mini SMP Female		PE91123	E2	17
N Female	(P)	PE9502	B3	17
N Male	(P)	PE9503	A3	17
SMA Female	(P)	PE9656	E4	35
SMA Male	(P)	PE9654	C5	33
SMP Female		PE91055	D3	17
SMP Male		PE91048	C3	17
<b>2.4mm In-Series:</b>				
Female to Female		PE9453	D6	16
Female to Female	(B)	PE91459	E6	16
Female to Female	(B)	PE9640	A7	16
Male to Female		PE9452	C6	16
Male to Male		PE9451	B6	16
<b>2.4mm Male To:</b>				
1.85mm Female		PE9674	D7	16
1.85mm Male		PE9672	C7	16
2.92mm Female	90°	PE91502	A1	17

Connector Type	Feature	Model No.	C/R	Page
<b>2.92mm Female</b>				
2.92mm Female		PE91451	E2	18
2.92mm Female		PE9454	A3	18
2.92mm Male	90°	PE91508	E7	16
2.92mm Male		PE91298	E6	17
2.92mm Male		PE9457	A7	17
3.5mm Female		PE91292	E2	19
3.5mm Female		PE9650	A3	19
3.5mm Male		PE91294	B1	19
3.5mm Male		PE9649	C1	19
7mm Sexless		PE9458	B1	17
Full Detent Mini SMP Male		PE91121	C1	17
Mini SMP Female		PE91120	D1	17
N Female	(P)	PE9501	A2	17
N Male	(P)	PE9504	E1	17
SMA Female		PE9655	D4	35
SMA Male	(P)	PE9653	B5	33
<b>2.4mm NMD Female To:</b>				
2.4mm Female		PE91145	A4	17
SMA Female	(RU)	PE91146	B4	17
<b>2.92mm Female To:</b>				
1.85mm Female		PE9668	D2	18
1.85mm Male		PE9665	C2	18
2.4mm Female		PE91295	B3	18
2.4mm Female		PE91499	C3	18
2.4mm Female		PE9456	D3	18
2.4mm Male		PE91451	E2	18
2.4mm Male		PE9454	A3	18
2.4mm Male	90°	PE91502	A1	17
3.5mm Female		PE9660	A4	18
3.5mm Female	90°	PE91167	B4	18
3.5mm Male	90°	PE91166	E3	18
3.5mm Male		PE9658	E1	19
7mm Sexless		PE9461	C4	18
Full Detent Mini SMP Male		PE91127	E4	18
Mini SMP Female		PE9782	B5	18
Mini SMP Male		PE9781	D4	18
N Female	(P)	PE9664	D5	18
N Male	(P)	PE9663	C5	18
SMA Female	(P)	PE91011	B5	35
SMA Male	(P)	PE91008	E5	33
Smooth Bore Mini SMP Male		PE91128	A5	18
SMP Female		PE91060	E5	18
SSMA Male		PE9768	A6	18
<b>2.92mm Male To:</b>				
2.92mm Male	(R)	PE91070	D7	17
<b>2.92mm In-Series:</b>				
Female to Female		PE91510	B5	17
Female to Female		PE9438	C5	17
Female to Female	(B)	PE9647	D5	17
Female to Female	(PM)	PE91113	E5	17
Female to Female	(PM)	PE9648	A6	17
Male to Female		PE9437	A5	17
Male to Male		PE9436	D4	17
Male to Male	90°	PE9645	E4	17
<b>2.92mm Male To:</b>				
1.85mm Female		PE9666	D6	17
1.85mm Female	90°	PE91162	C5	16
1.85mm Male		PE9667	C6	17
1.85mm Male	90°	PE91161	C4	16
2.4mm Female		PE91450	B7	17
2.4mm Female		PE9455	C7	17
2.4mm Male		PE91298	E6	17
2.4mm Male		PE9457	A7	17
2.4mm Male	90°	PE91508	E7	16
2.92mm Female	(R)	PE91070	D7	17
3.5mm Female	90°	PE91168	A1	18
3.5mm Female		PE9659	D3	19
3.5mm Male	90°	PE91165	E7	17
7mm Sexless		PE9460	B1	18
Mini SMP Female		PE91126	E1	18
Mini SMP Male		PE91124	C1	18
N Female	(P)	PE9662	B2	18
N Male	(P)	PE9661	A2	18
SMA Female	(P)	PE91009	A5	35
SMA Male	(P)	PE91010	D5	33
Smooth Bore Mini SMP Male		PE91125	D1	18
<b>2.92mm NMD Female To:</b>				
2.4mm Female		PE91144	B5	42
<b>3.5mm Female To:</b>				
1.85mm Female		PE9748	D2	19
1.85mm Male		PE9747	D4	16
2.4mm Female		PE91291	B3	19
2.4mm Female		PE9652	C3	19
2.4mm Male		PE91292	E2	19
2.4mm Male		PE9650	A3	19
2.92mm Female		PE9660	A4	18
2.92mm Female	90°	PE91167	B4	18
2.92mm Male		PE9659	D3	19
2.92mm Male	90°	PE91168	A1	18
7mm Sexless	(P)	PE9325	E3	19
N Female	(P)	PE9323	B4	19
N Male	(P)	PE9321	A4	19
SMA Female		PE9725	D5	35
<b>3.5mm In-Series:</b>				

Connector Type	Feature	Model No.	C/R	Page
<b>Female to Female</b>				
Female to Female		PE9331	A7	18
Female to Female	(B)	PE9678	B7	18
Female to Female	(PM)	PE9676	C7	18
Male to Female		PE9332	E6	18
Male to Male		PE9330	C6	18
Male to Male	90°	PE91169	D6	18
<b>3.5mm Male To:</b>				
1.85mm Female		PE9745	A1	19
1.85mm Male		PE9746	E7	18
2.4mm Female		PE9651	D1	19
2.4mm Male		PE91294	B1	19
2.4mm Male		PE9649	C1	19
2.92mm Female		PE9658	E1	19
2.92mm Female	90°	PE91166	E3	18
2.92mm Male	90°	PE91165	E7	17
7mm Sexless	(P)	PE9326	A2	19
N Female	(P)	PE9324	C2	19
N Male	(P)	PE9322	B2	19
SMA Female		PE9724	C5	35
SMA Male		PE9722	A6	33
<b>3.5mm NMD Female To:</b>				
2.4mm Female		PE91148	D4	19
SMA Female	(RU)	PE91147	E4	19
<b>4.1/9.5 Mini DIN Female To:</b>				
7/16 DIN Female		PE91208	A1	22
7/16 DIN Female		PE91245	B1	22
7/16 DIN Female	(LP)	PE91091	C1	22
7/16 DIN Female	(B)	PE91210	D1	22
7/16 DIN Female	(B)	PE91247	E1	22
7/16 DIN Male		PE91207	A5	21
7/16 DIN Male		PE91244	B5	21
7/16 DIN Male	(LP)	PE91089	C5	21
N Female		PE91218	B2	20
N Female		PE91255	C2	20
N Female	(LP)	PE91095	D2	20
N Female	(B)	PE91220	E2	20
N Female	(B)	PE91257	A3	20
N Male		PE91219	D1	20
N Male		PE91256	E1	20
N Male	(LP)	PE91094	A2	20
<b>4.1/9.5 Mini DIN In-Series:</b>				
Female to Female		PE91233	D6	19
Female to Female	(B)	PE91197	E6	19
Female to Female	(B)	PE91234	A7	19
Male to Female		PE91195	B6	19
Male to Female		PE91232	C6	19
Male to Male		PE91194	E5	19
Male to Male		PE91231	A6	19
<b>4.1/9.5 Mini DIN Male To:</b>				
7/16 DIN Female		PE91209	C7	21
7/16 DIN Female		PE91246	D7	21
7/16 DIN Female	(LP)	PE91090	E7	21
7/16 DIN Male		PE91206	C4	21
7/16 DIN Male		PE91243	D4	21
7/16 DIN Male	(LP)	PE91088	E4	21
N Female		PE91217	A1	20
N Female		PE91254	B1	20
N Female	(LP)	PE91093	C1	20
N Male		PE91216	C7	19
N Male		PE91253	D7	19
N Male	(LP)	PE91092	E7	19
<b>4.3-10 Female To:</b>				
7/16 DIN Female	(LP)	PE91471	D2	22
7/16 DIN Male	(LP)	PE91469	E5	21
7/16 DIN Male	(LP)	PE91390	A6	21
N Female	(LP)	PE91475	A7	20
N Male	(LP)	PE91479	D6	20
N Male	(LP)	PE91388	A4	28
<b>4.3-10 In-Series:</b>				
Female to Female	(LP)	PE91464	C4	20
Female to Female	(LP)	PE91386	D4	20
Male to Female	(LP)	PE91465	E3	20
Male to Female	(LP) 90°	PE91467	A4	20
Male to Female	(LP)	PE91387	B4	20
Male to Male	(LP)	PE91466	C3	20
Male to Male	(LP)	PE91385	D3	20
<b>4.3-10 Male To:</b>				
7/16 DIN Female	(LP)	PE91470	A2	22
7/16 DIN Female	(LP)	PE91391	C2	22
7/16 DIN Female	(LP)	PE91468	D5	21
N Female	(LP)	PE91474	C5	20
N Female	(LP)	PE91477	D5	20
N Female	(LP) 90°	PE91483	A6	20
N Female	(LP)	PE91389	B6	20
N Male	(LP)	PE91476	A5	20
SMA Female	(LP)	PE91484	C6	20
<b>7/16 DIN Female To:</b>				
4.1/9.5 Mini DIN Female		PE91208	A1	22
4.1/9.5 Mini DIN Female		PE91245	B1	22
4.1/9.5 Mini DIN Female	(LP)	PE91091	C1	22
4.1/9.5 Mini DIN Female	(B)	PE91210	D1	22
4.1/9.5 Mini DIN Female	(B)	PE91247	E1	22
4.1/9.5 Mini DIN Male		PE91209	C7	21
4.1/9.5 Mini DIN Male		PE91246	D7	21
4.1/9.5 Mini DIN Male	(LP)	PE91090	E7	21
4.3-10 Female	(LP)	PE91471	D2	22
4.3-10 Male	(LP)	PE91470	A2	22
4.3-10 Male	(LP)	PE91391	C2	22

Feature: (B) Bulkhead Mount / (H) Hermetically Sealed / (I) Isolated Sealed / (LP) Low PIM / (P) Precision / (PM) Panel Mount / (PO) Push On / (QD) Quick Disconnect / (R) Radius Right Angle / (RU) Ruggedized / (SO) Snap-On

# Adapter Locator

Adapters

Connector Type	Feature	Model No.	C/R	Page
HN Male		PE9559	A3	22
N Female		PE91213	D3	22
N Female		PE91250	E3	22
N Female	(B)	PE91215	A4	22
N Female	(B)	PE91252	B4	22
N Female	(LP)	PE91033	B5	29
N Female	(LP)	PE9180	C5	29
N Male		PE91214	B3	22
N Male		PE91251	C3	22
N Male	(LP)	PE91032	D4	28
N Male		PE91134	E4	28
QD 4.3-10 Female	(LP) (QD)	PE91473	E2	22
QD 4.3-10 Male	(LP) (QD)	PE91472	B2	22
SMA Female	(LP)	PE91042	D6	35
SMA Male	(LP)	PE91041	D6	33
SMA Male		PE9411	E6	33
TNC Female		PE91392	B6	41
TNC Male		PE9638	C3	41
<b>7/16 DIN In-Series:</b>				
Female to Female		PE91192	C2	21
Female to Female		PE91229	D2	21
Female to Female	(LP)	PE91029	E2	21
Female to Female		PE9409	A3	21
Female to Female		PE9556	B3	21
Female to Female	(B) (LP)	PE91038	C3	21
Female to Female	(B)	PE9414	D3	21
Female to Female	(B)	PE91193	E3	21
Female to Female	(B)	PE91230	A4	21
Female to Male		PE9557	B2	21
Male to Female		PE91191	B1	21
Male to Female		PE91228	C1	21
Male to Female		PE91027	D1	21
Male to Female	(LP)	PE91028	E1	21
Male to Female	90°	PE91117	A2	21
Male to Male		PE91190	D7	20
Male to Male		PE91227	E7	20
Male to Male	(LP)	PE91039	A1	21
<b>7/16 DIN Male To:</b>				
4.1/9.5 Mini DIN Female		PE91207	A5	21
4.1/9.5 Mini DIN Female		PE91244	B5	21
4.1/9.5 Mini DIN Female	(LP)	PE91089	C5	21
4.1/9.5 Mini DIN Male		PE91206	C4	21
4.1/9.5 Mini DIN Male		PE91243	D4	21
4.1/9.5 Mini DIN Male	(LP)	PE91088	E4	21
4.3-10 Female	(LP)	PE91469	E5	21
4.3-10 Female	(LP)	PE91390	A6	21
4.3-10 Male	(LP)	PE91468	D5	21
HN Female		PE9558	B6	21
N Female		PE91212	E6	21
N Female		PE91249	A7	21
N Female	(LP)	PE91031	A5	29
N Male		PE91211	C6	21
N Male		PE91248	D6	21
N Male	(LP)	PE91030	B4	28
N Male		PE9535	C4	28
SC Female		PE91444	B7	21
SMA Female	(LP)	PE91036	B6	35
SMA Female		PE91175	C6	35
SMA Male	(LP)	PE91043	C6	33
<b>75 Ohm BNC Female To:</b>				
75 Ohm F Female	(B)	PE91324	A7	42
75 Ohm F Female		PE9744	B3	43
75 Ohm F Male		PE9743	C2	43
75 Ohm Mini SMB Jack		PE9619	D5	43
75 Ohm Mini SMB Plug		PE9617	B5	43
75 Ohm N Female		PE9371	B3	44
75 Ohm N Male		PE9369	D7	43
75 Ohm TNC Male		PE9631	C3	45
<b>75 Ohm BNC In-Series:</b>				
Female to Female		PE9362	B6	42
Female to Female	(B)	PE9363	C6	42
Female to Female	(PM)	PE9367	D6	42
Female to Male		PE9365	A6	42
Male to Female	90°	PE9361	E5	42
Male to Male		PE9364	D5	42
<b>75 Ohm BNC Male To:</b>				
75 Ohm F Female		PE9741	A3	43
75 Ohm F Male		PE9742	B2	43
75 Ohm Mini SMB Jack		PE9618	C5	43
75 Ohm Mini SMB Plug		PE9616	A5	43
75 Ohm N Female		PE9368	A3	44
75 Ohm N Male		PE9370	C7	43
75 Ohm TNC Female		PE9630	A4	45
<b>75 Ohm F Female To:</b>				
75 Ohm BNC Female	(B)	PE9744	A7	42
75 Ohm BNC Male		PE9741	A3	43
75 Ohm N Female		PE9740	E3	44
75 Ohm N Male		PE9396	A1	44
75 Ohm N Male		PE9737	B1	44
75 Ohm PAL Jack		PE9634	C3	43
75 Ohm RCA Plug		PE9163	D3	43
75 Ohm TNC Female		PE91082	C4	45
75 Ohm TNC Male		PE91080	E3	45
BNC Female		PE9153	A1	24
BNC Male		PE9150	A6	23
N Male		PE9155	A7	28
SMA Female		PE91002	B1	36

Connector Type	Feature	Model No.	C/R	Page
SMA Male		PE91003	E7	33
UHF Female		PE9167	D4	42
UHF Male		PE9165	D3	42
<b>75 Ohm F In-Series:</b>				
Female to Female	(P)	PE91349	C1	43
Female to Female		PE9164	D1	43
Female to Female	(B)	PE9734	E1	43
Male to Female	(PO)	PE9160	E7	42
Male to Female		PE9759	A1	43
Male to Female	90°	PE9166	B1	43
Male to Male	(P)	PE91348	C7	42
Male to Male		PE9760	D7	42
<b>75 Ohm F Male To:</b>				
75 Ohm BNC Female		PE9743	C2	43
75 Ohm BNC Male		PE9742	B2	43
75 Ohm N Female		PE9397	C3	44
75 Ohm N Female		PE9739	D3	44
75 Ohm N Male		PE9738	E7	43
75 Ohm PAL Jack		PE9632	E2	43
75 Ohm PAL Plug		PE9633	D2	43
75 Ohm TNC Female		PE91083	B4	45
75 Ohm TNC Male		PE91081	D3	45
BNC Female		PE9151	E7	23
BNC Male		PE9152	E5	23
N Female		PE9389	E7	29
SMA Female		PE91045	A1	36
<b>75 Ohm Mini SMB In-Series:</b>				
Jack to Jack		PE9608	C4	43
Jack to Jack	(B)	PE9611	D4	43
Plug to Jack		PE9610	B4	43
Plug to Plug		PE9609	A4	43
<b>75 Ohm Mini SMB Jack To:</b>				
75 Ohm BNC Female		PE9619	D5	43
75 Ohm BNC Male		PE9618	C5	43
75 Ohm N Female		PE9615	B4	44
75 Ohm N Male		PE9614	D1	44
75 Ohm SMB Plug		PE9736	B7	44
<b>75 Ohm Mini SMB Plug To:</b>				
75 Ohm BNC Female		PE9617	B5	43
75 Ohm BNC Male		PE9616	A5	43
75 Ohm N Female		PE9613	A4	44
75 Ohm N Male		PE9612	C1	44
75 Ohm SMB Jack		PE9735	D7	44
<b>75 Ohm N Female To:</b>				
75 Ohm BNC Female		PE9371	B3	44
75 Ohm BNC Male		PE9368	A3	44
75 Ohm F Female		PE9740	E3	44
75 Ohm F Male		PE9397	C3	44
75 Ohm F Male		PE9739	D3	44
75 Ohm Mini SMB Jack		PE9615	B4	44
75 Ohm Mini SMB Plug		PE9613	A4	44
75 Ohm SMB Jack		PE9583	D4	44
75 Ohm SMB Plug		PE9585	C4	44
75 Ohm SMC Jack		PE9587	A5	44
75 Ohm SMC Plug		PE9589	E4	44
75 Ohm TNC Female		PE9629	C5	44
75 Ohm TNC Male		PE9628	B5	44
<b>75 Ohm N In-Series:</b>				
Female to Female		PE9306	D6	43
Female to Female	(B)	PE9417	E6	43
Female to Female	(B)	PE9416	A7	43
Male to Female		PE9391	B6	43
Male to Female	90°	PE9307	C6	43
Male to Male		PE9308	A6	43
<b>75 Ohm N Male To:</b>				
75 Ohm BNC Female		PE9369	D7	43
75 Ohm BNC Male		PE9370	C7	43
75 Ohm F Female		PE9396	A1	44
75 Ohm F Female		PE9737	B1	44
75 Ohm F Male		PE9738	E7	43
75 Ohm Mini SMB Jack		PE9614	D1	44
75 Ohm Mini SMB Plug		PE9612	C1	44
75 Ohm SMB Jack		PE9582	A2	44
75 Ohm SMB Plug		PE9584	E1	44
75 Ohm SMC Jack		PE9586	B2	44
75 Ohm SMC Plug		PE9588	C2	44
75 Ohm TNC Female		PE9627	E2	44
75 Ohm TNC Male		PE9626	D2	44
<b>75 Ohm PAL In-Series:</b>				
Plug to Plug		PE9680	E5	44
<b>75 Ohm PAL Jack To:</b>				
75 Ohm F Female		PE9634	C3	43
75 Ohm F Male		PE9632	E2	43
<b>75 Ohm PAL Plug To:</b>				
75 Ohm F Male		PE9633	D2	43
<b>75 Ohm Push-On RCA Jack To:</b>				
BNC Male		PE9171	C6	23
<b>75 Ohm RCA Jack To:</b>				
BNC Female		PE9015	C1	24
<b>75 Ohm RCA Plug To:</b>				
75 Ohm F Female		PE9163	D3	43
BNC Female		PE9158	B1	24
<b>75 Ohm SMB In-Series:</b>				
Jack to Jack		PE9248	D6	44
Jack to Plug		PE9245	C6	44
Plug to Plug		PE9271	B6	44
<b>75 Ohm SMB Jack To:</b>				

Connector Type	Feature	Model No.	C/R	Page
75 Ohm Mini SMB Plug		PE9735	D7	44
75 Ohm N Female		PE9583	D4	44
75 Ohm N Male		PE9582	A2	44
BNC Female		PE9231	D1	24
BNC Male		PE9229	C7	44
<b>75 Ohm SMB Plug To:</b>				
75 Ohm Mini SMB Jack		PE9736	B7	44
75 Ohm N Female		PE9585	C4	44
75 Ohm N Male		PE9584	E1	44
BNC Female		PE9232	A7	44
BNC Male		PE9230	D6	23
<b>75 Ohm SMC In-Series:</b>				
Jack to Jack		PE9227	C1	45
Jack to Jack	(B)	PE9228	D1	45
Jack to Plug		PE9244	B1	45
Plug to Plug		PE9272	A1	45
<b>75 Ohm SMC Jack To:</b>				
75 Ohm N Female		PE9587	A5	44
75 Ohm N Male		PE9586	C2	44
BNC Female		PE9235	A2	45
BNC Male		PE91044	A7	23
<b>75 Ohm SMC Plug To:</b>				
75 Ohm N Female		PE9589	E4	44
75 Ohm N Male		PE9588	B2	44
BNC Female		PE9236	E1	24
BNC Male		PE9234	E6	23
<b>75 Ohm TNC Female To:</b>				
75 Ohm BNC Male		PE9630	A4	45
75 Ohm F Female		PE91082	C4	45
75 Ohm F Male		PE91083	B4	45
75 Ohm N Female		PE9629	C5	44
75 Ohm N Male		PE9627	E2	44
<b>75 Ohm TNC In-Series:</b>				
Female to Female		PE9622	D2	45
Female to Female	(B)	PE9625	E2	45
Female to Female	(B)	PE9624	A3	45
Male to Female	90°	PE9623	C2	45
<b>75 Ohm TNC Male To:</b>				
75 Ohm BNC Female		PE9631	C3	45
75 Ohm F Female		PE91080	E3	45
75 Ohm F Male		PE91081	D3	45
75 Ohm N Female		PE9628	B5	44
75 Ohm N Male		PE9626	D2	44
<b>78 Ohm BNC Twinax In-Series:</b>				
Jack to Jack		PE9378	C5	45
Jack to Jack	(B)	PE9280	D5	45
Jack to Plug		PE9375	B5	45
Plug to Jack	90°	PE9377	A5	45
Plug to Plug		PE9376	E4	45
<b>7mm Sexless To:</b>				
2.4mm Male		PE9458	B1	17
2.92mm Female		PE9461	C4	18
2.92mm Male		PE9460	B1	18
3.5mm Female	(P)	PE9325	E3	19
3.5mm Male	(P)	PE9326	A2	19
BNC Female		PE9220	D5	19
BNC Male		PE9221	B5	19
N Female	(P)	PE9216	E4	29
N Male	(P)	PE9217	E3	28
SMA Female	(P)	PE9214	E5	35
SMA Female	(P) (PM)	PE9327	A6	35
SMA Male	(P)	PE9215	B6	33
SSMA Female	(P)	PE9356	A1	40
TNC Female	(P)	PE9218	A6	41
TNC Male	(P)	PE9219	B3	41
<b>95 Ohm 3/4"-20 Twinax In-Series:</b>				
Female to Female		PE9199	B6	45
Female to Female		PE9224	C6	45
Female to Female	(B)	PE9373	D6	45
Female to Male		PE9374	A6	45
<b>Banana Plug To:</b>				
BNC Female		PE9175	A7	45
<b>BMA In-Series:</b>				
Jack to Jack		PE91395	D6	22
<b>BNC Female To:</b>				
10-32 Female		PE9752	A6	22
10-32 Female	(B)	PE9754	B6	22
10-32 Male		PE9753	C5	22
10-32 Male	(B)	PE9755	D5	22
75 Ohm F Female		PE9153	A1	24
75 Ohm F Male		PE9151	E7	23
75 Ohm RCA Jack		PE9015	C1	24
75 Ohm RCA Plug		PE9158	B1	24
75 Ohm SMB Jack		PE9231	D1	24
75 Ohm SMB Plug		PE9232	A7	44
75 Ohm SMC Jack		PE9235	A2	45
75 Ohm SMC Plug		PE9236	E1	24
7mm Sexless		PE9220	D5	19
Banana Plug		PE9175	A7	45
C Female		PE9537	C7	23
C Female	(B)	PE9204	D7	23
C Male		PE9087	B7	23
FME Jack		PE9712	C5	24
GR874 Sexless		PE9222	D6	24
HN Male		PE9126	C2	25
MCX Jack		PE9466	A7	25
MCX Jack	(B)	PE9520	B7	25

Feature: (B) Bulkhead Mount / (H) Hermetically Sealed / (I) Isolated Sealed / (LP) Low PIM / (P) Precision / (PM) Panel Mount / (PO) Push On / (QD) Quick Disconnect / (R) Radius Right Angle / (RU) Ruggedized / (SO) Snap-On



Technical Support  
+1 (949) 261-1920



Same-Day Shipping,  
Even Custom  
Cable Assemblies

# Adapter Locator

Connector Type	Feature	Model No.	C/R	Page
MCX Plug		PE9467	D6	25
Mini UHF Male		PE9342	C4	26
MMCX Jack		PE9516	D7	26
MMCX Plug		PE9519	E6	26
N Female		PE9206	C6	29
N Female	(P)	PE9492	D6	29
N Female	(B)	PE9261	E6	29
N Female	(PM)	PE9238	A7	29
N Female	(B)	PE9540	B7	29
N Male		PE9002	D5	28
N Male	(P)	PE9491	E5	28
N Male	90°	PE9278	A6	38
N Male	(PM)	PE9388	B6	28
SC Female		PE9571	D3	31
SC Male		PE9200	C3	31
SMA Female		PE9075	B7	35
SMA Female		PE9496	C7	35
SMA Female	(B)	PE9185	D7	35
SMA Female	(B)	PE9407	E7	35
SMA Male		PE9074	C7	33
SMA Male		PE9495	D7	33
SMB Jack		PE9136	B6	38
SMB Jack	(B)	PE9240	C6	38
SMB Plug		PE9137	D5	38
SMB Plug	(B)	PE9241	E5	38
SMC Jack		PE9140	D2	39
SMC Jack	(B)	PE9108	E2	39
SMC Plug		PE9141	E1	39
SSMA Male		PE91046	D7	39
SSMB Jack		PE9394	D2	40
SSMB Plug		PE9395	B2	40
TNC Female		PE9097	D6	41
TNC Male		PE9088	D3	41
TNC Male	90°	PE9783	E3	41
UHF Female		PE9421	C4	42
UHF Male		PE91328	C3	42
<b>BNC In-Series:</b>				
Female to Female		PE9084	A3	23
Female to Female		PE9003	B3	23
Female to Female	(B)	PE9420	C3	23
Female to Female	(B)	PE9093	D3	23
Female to Female	(B)	PE9172	E3	23
Female to Female	(PM)	PE9106	A4	23
Female to Male		PE9001	E2	23
Male to Female		PE9269	A2	23
Male to Female	90°	PE9085	B2	23
Male to Female		PE9174	C2	23
Male to Female		PE9484	D2	23
Male to Male		PE9000	D1	23
Male to Male	90°	PE9758	E1	23
<b>BNC Male To:</b>				
10-32 Female		PE9750	E5	22
10-32 Male		PE9751	B5	22
75 Ohm F Female		PE9150	A6	23
75 Ohm F Male		PE9152	E5	23
75 Ohm Push-On RCA		PE9171	C6	23
Jack		PE9229	C7	44
75 Ohm SMB Jack		PE9230	D6	23
75 Ohm SMB Plug		PE91044	A7	23
75 Ohm SMC Jack		PE9234	E6	23
75 Ohm SMC Plug		PE9221	B5	19
7mm Sexless		PE91104	B5	23
BNC Triax Female		PE9109	D5	23
C Female		PE9536	C5	23
C Male		PE9536	C5	23
Double Banana Binding		PE9011	A5	23
Post Jack		PE9711	B5	24
FME Jack		PE9697	E4	24
FME Plug		PE9698	A5	24
FME Plug	90°	PE9223	C6	24
GR874 Sexless		PE9129	C3	25
HN Female		PE9567	B2	25
HN Male		PE9468	E6	25
MCX Jack		PE9469	C6	25
MCX Plug		PE9406	B6	23
MHV Female		PE9341	B5	26
Mini UHF Female		PE9518	C7	26
MMCX Jack		PE9517	D6	26
MMCX Plug		PE9005	D5	29
N Female	(P)	PE9490	E5	29
N Female	90°	PE9566	A6	29
N Female	(PM)	PE9123	B6	29
N Male		PE9127	A5	28
N Male	(P)	PE9489	B5	28
N Male	90°	PE9565	C5	28
Reverse Polarity TNC		PE91067	D1	42
Female		PE9568	B3	31
SC Male		PE9073	E6	35
SMA Female		PE9494	A7	35
SMA Female		PE9072	A7	33
SMA Male		PE9493	B7	33
SMA Male		PE9132	A6	38
SMB Jack		PE9135	C5	38
SMB Plug		PE9138	C2	39
SMC Jack		PE9139	D1	39
SMC Plug		PE9191	B1	40
SSMA Female		PE9213	C7	39
SSMA Male		PE9213	C7	39

Connector Type	Feature	Model No.	C/R	Page
SSMB Jack		PE9392	C2	40
SSMB Plug		PE9393	A2	40
TNC Female		PE9098	C6	41
UHF Female		PE91329	B4	42
UHF Male		PE9201	B3	42
<b>BNC Triax Female To:</b>				
BNC Male		PE91104	B5	23
<b>BNC Triax In-Series:</b>				
Female to Female		PE91107	D7	45
Female to Female	(B)	PE91105	E7	45
Male to Female		PE91106	C7	45
<b>C Female To:</b>				
BNC Female		PE9537	C7	23
BNC Female	(B)	PE9204	D7	23
BNC Male		PE9109	D5	23
GR874 Sexless		PE9301	E6	24
HN Male		PE9296	E2	25
N Female		PE9539	D7	29
N Male		PE91446	D6	28
N Male	90°	PE9239	E6	28
TNC Male		PE9562	A4	41
<b>C In-Series:</b>				
Female to Female		PE9208	E2	24
Female to Female		PE9294	A3	24
Female to Female	(B)	PE9186	B3	24
Female to Male		PE9207	D2	24
Male to Female	90°	PE9293	C2	24
Male to Male		PE9300	B2	24
<b>C Male To:</b>				
BNC Female		PE9087	B7	23
BNC Male		PE9536	C5	23
HN Female		PE9212	D3	25
HN Male		PE9579	D2	25
N Female		PE9295	C7	29
N Male		PE9538	C6	28
TNC Female		PE9564	E6	41
<b>Double Banana Binding Post Jack To:</b>				
BNC Male		PE9011	A5	23
<b>D-Sub In-Series:</b>				
Plug to Plug		PE9688	D3	24
Plug to Receptacle		PE9687	E3	24
Receptacle to Receptacle		PE9689	A4	24
<b>FME In-Series:</b>				
Plug to Plug		PE9696	C4	24
<b>FME Jack To:</b>				
BNC Female		PE9712	C5	24
BNC Male		PE9711	B5	24
Mini UHF Female		PE9710	C5	26
Mini UHF Male		PE9709	A5	26
SMA Female		PE9708	D1	36
SMA Male		PE9707	A1	34
TNC Female		PE9714	A7	41
TNC Male		PE9713	D4	41
<b>FME Plug To:</b>				
BNC Male		PE9697	E4	24
BNC Male	90°	PE9698	A5	24
Mini UHF Male		PE9705	D4	26
Mini UHF Male	90°	PE9706	E4	26
N Male		PE9704	B7	28
SMA Female		PE9703	C1	36
TNC Male		PE9699	B4	41
TNC Male	90°	PE9700	C4	41
UHF Male		PE9701	E3	42
<b>Full Detent Mini SMP Male To:</b>				
2.4mm Female		PE91122	D2	17
2.4mm Male		PE91121	C1	17
2.92mm Female		PE91127	E4	18
SMA Female		PE91299	E2	36
SMA Female		PE91129	A3	36
SMA Male		PE91302	B2	34
SMA Male	(P)	PE91052	D2	34
<b>Full Detent SMP Male To:</b>				
SMA Female		PE91305	B1	37
SMA Female	(P)	PE91056	D1	37
SMA Female	(B)	PE91054	D1	37
SMA Female	(P) (PM)	PE91058	E1	37
SMA Male		PE91309	E6	34
SMA Male	(P)	PE91063	C7	34
<b>GR874 In-Series:</b>				
Sexless to Sexless	90°	PE9286	E5	24
Sexless to Sexless		PE9285	A6	24
<b>GR874 Sexless To:</b>				
BNC Female		PE9222	D6	24
BNC Male		PE9223	C6	24
C Female		PE9301	E6	24
HN Female		PE9387	E3	25
HN Male		PE9386	A3	25
N Female		PE9258	A1	30
N Male		PE9257	C7	28
SMA Female		PE9260	E1	36
SMA Male		PE9259	B1	34
<b>HN Female To:</b>				
7/16 DIN Male		PE9558	B6	21
BNC Male		PE9129	C3	25
C Male		PE9212	D3	25
GR874 Sexless		PE9387	E3	25
LC Male		PE9181	A5	25

Connector Type	Feature	Model No.	C/R	Page
N Female		PE9360	C1	30
N Female	(PM)	PE9553	D1	30
N Male		PE9125	E7	28
SMA Female		PE9255	B2	36
SMA Male		PE9256	D1	34
<b>HN In-Series:</b>				
Female to Female		PE9580	C1	25
Female to Female		PE9574	D1	25
Female to Female	(B)	PE9193	E1	25
Female to Male		PE9575	B1	25
Male to Female		PE9576	D7	24
Male to Female	90°	PE9205	E7	24
Male to Female		PE9578	A1	25
Male to Male		PE9210	B7	24
Male to Male	90°	PE9577	C7	24
<b>HN Male To:</b>				
7/16 DIN Female		PE9559	A3	22
BNC Female		PE9126	C2	25
BNC Male		PE9567	B2	25
C Female		PE9296	E2	25
C Male		PE9579	D2	25
GR874 Sexless		PE9386	A3	25
LC Female		PE9413	B5	25
MHV Female		PE9264	B3	25
N Female		PE9194	B1	30
N Male		PE9554	D7	28
SMA Female		PE9253	A2	36
SMA Male		PE91448	C1	34
TNC Male		PE9563	E4	41
<b>LC Female To:</b>				
HN Male		PE9413	B5	25
N Female		PE9298	A2	30
N Male		PE9299	A1	29
<b>LC In-Series:</b>				
Female to Female		PE9419	D4	25
Female to Female	90°	PE9398	C4	25
Male to Male		PE9569	B4	25
<b>LC Male To:</b>				
HN Female		PE9181	A5	25
N Female		PE9237	E1	30
<b>Limited Detent SMP Male To:</b>				
SMA Female		PE91306	A2	37
SMA Female	(P)	PE91050	B2	37
SMA Female	(P)	PE9512	C2	37
SMA Female		PE9778	D2	37
SMA Female	(P) (PM)	PE91066	E2	37
SMA Male		PE91310	A7	34
SMA Male	(P)	PE9511	D7	34
TNC Female	(B)	PE91073	A1	42
<b>MCX In-Series:</b>				
Jack to Jack		PE9524	E5	25
Jack to Jack	(B)	PE9474	A6	25
Plug to Jack		PE9479	D5	25
<b>MCX Jack To:</b>				
BNC Female		PE9466	A7	25
BNC Female	(B)	PE9520	B7	25
BNC Male		PE9468	E6	25
MMCX Jack		PE9526	A1	27
MMCX Plug		PE9525	B7	26
N Female		PE9462	C2	30
N Male		PE9464	C1	29
SMA Female		PE9470	D2	36
SMA Male		PE9472	A2	34
TNC Female		PE9544	C7	41
TNC Female	(B)	PE9521	D7	41
TNC Male		PE9542	B5	41
<b>MCX Plug To:</b>				
BNC Female		PE9467	D6	25
BNC Male		PE9469	C6	25
MMCX Jack		PE9528	E7	26
MMCX Plug		PE9527	A7	26
N Female		PE9463	B2	30
N Male		PE9465	B1	29
SMA Female		PE9471	C2	36
SMA Male		PE9473	E1	34
TNC Female		PE9545	B7	41
TNC Male		PE9543	A5	41
<b>MHV Female To:</b>				
BNC Male		PE9406	B6	23
HN Male		PE9264	B3	25
SHV Jack		PE9339	C2	26
SHV Plug		PE9265	B2	26
<b>MHV In-Series:</b>				
Female to Female		PE9267	B1	26
Female to Female	(B)	PE9268	C1	26
Female to Male		PE9211	A1	26
Male to Female		PE9297	D7	25
Male to Female	90°	PE9266	E7	25
<b>MHV Male To:</b>				
SHV Jack		PE9335	A2	26
SHV Plug		PE9340	E1	26
<b>Mini SMP Female To:</b>				
2.4mm Female		PE91123	E2	17
2.4mm Male		PE91120	D1	17
2.92mm Female		PE9782	B5	18
2.92mm Male		PE91126	E1	18

Feature: (B) Bulkhead Mount / (H) Hermetically Sealed / (I) Isolated Sealed / (LP) Low PIM / (P) Precision / (PM) Panel Mount / (PO) Push On / (QD) Quick Disconnect / (R) Radius Right Angle / (RU) Ruggedized / (SO) Snap-On

# Adapter Locator

Adapters

Connector Type	Feature	Model No.	C/R	Page
SMA Female		PE91301	C3	36
SMA Female	(P)	PE91051	D3	36
SMA Female		PE91304	E2	34
SMA Male	(P)	PE91103	A3	34
<b>Mini SMP In-Series:</b>				
Female to Female		PE9780	E2	26
Female to Female		PE91069	A3	26
<b>Mini SMP Male To:</b>				
2.92mm Female		PE9781	D4	18
2.92mm Male		PE91124	C1	18
<b>Mini UHF Female To:</b>				
BNC Male		PE9341	B5	26
FME Jack		PE9710	C5	26
N Male		PE9064	D1	29
TNC Male		PE9345	C5	41
UHF Male		PE9348	A4	42
<b>Mini UHF In-Series:</b>				
Female to Female		PE9343	E3	26
Female to Female		PE9066	A4	26
Female to Male		PE9065	D3	26
Male to Female	90°	PE9347	C3	26
<b>Mini UHF Male To:</b>				
BNC Female		PE9342	C4	26
FME Jack		PE9709	A5	26
FME Plug		PE9705	D4	26
FME Plug	90°	PE9706	E4	26
N Female		PE9183	D2	30
TNC Female		PE9346	E7	41
UHF Female		PE91447	E4	42
<b>MMBX In-Series:</b>				
Plug to Plug	(SO)	PE91370	C1	27
Plug to Plug	(SO)	PE91373	D1	27
Plug to Plug		PE91371	E1	27
Plug to Plug	(SO)	PE91372	A2	27
<b>MMCX In-Series:</b>				
Jack to Jack		PE9523	A6	26
Jack to Jack	(B)	PE9522	B6	26
Plug to Jack		PE9480	E5	26
<b>MMCX Jack To:</b>				
BNC Female		PE9516	D7	26
BNC Male		PE9518	C7	26
MCX Jack		PE9526	A1	27
MCX Plug		PE9528	E7	26
SMA Female		PE9477	A4	36
SMA Male		PE9478	C3	34
<b>MMCX Plug To:</b>				
BNC Female		PE9519	E6	26
BNC Male		PE9517	D6	26
MCX Jack		PE9525	B7	26
MCX Plug		PE9527	A7	26
SMA Female		PE9475	E3	36
SMA Male		PE9476	B3	34
<b>N Female To:</b>				
1.85mm Female		PE9721	E5	16
1.85mm Male		PE9719	A5	16
2.4mm Female	(P)	PE9502	B3	17
2.4mm Male	(P)	PE9501	A2	17
2.92mm Female	(P)	PE9664	D5	18
2.92mm Male	(P)	PE9662	B2	18
3.5mm Female	(P)	PE9323	B4	19
3.5mm Male	(P)	PE9324	C2	19
4.1/9.5 Mini DIN Female		PE91218	B2	20
4.1/9.5 Mini DIN Female		PE91255	C2	20
4.1/9.5 Mini DIN Female	(LP)	PE91095	D2	20
4.1/9.5 Mini DIN Female	(B)	PE91220	E2	20
4.1/9.5 Mini DIN Female	(B)	PE91257	A3	20
4.1/9.5 Mini DIN Male		PE91217	A1	20
4.1/9.5 Mini DIN Male		PE91254	B1	20
4.1/9.5 Mini DIN Male	(LP)	PE91093	C1	20
4.3-10 Female	(LP)	PE91475	A7	20
4.3-10 Male	(LP)	PE91474	C5	20
4.3-10 Male	(LP)	PE91477	D5	20
4.3-10 Male	(LP) 90°	PE91483	A6	20
4.3-10 Male	(LP)	PE91389	B6	20
7/16 DIN Female	(LP)	PE91033	B5	29
7/16 DIN Female	(LP)	PE9180	C5	29
7/16 DIN Female		PE91213	D3	22
7/16 DIN Female		PE91250	D3	22
7/16 DIN Female	(B)	PE91215	A4	22
7/16 DIN Female	(B)	PE91252	B4	22
7/16 DIN Male	(LP)	PE91031	A5	29
7/16 DIN Male		PE91212	E6	21
7/16 DIN Male		PE91249	A7	21
75 Ohm F Male		PE9389	E7	29
7mm Sexless	(P)	PE9216	E4	29
BNC Female		PE9206	C6	29
BNC Female	(P)	PE9492	D6	29
BNC Female	(B)	PE9261	E6	29
BNC Female	(PM)	PE9238	A7	29
BNC Female	(B)	PE9540	B7	29
BNC Male		PE9005	D5	29
BNC Male	(P)	PE9490	E5	29
BNC Male	90°	PE9566	A6	29
BNC Male	(PM)	PE9123	B6	29
C Female		PE9539	D7	29
C Male		PE9295	C7	29
GR874 Sexless		PE9258	A1	30

Connector Type	Feature	Model No.	C/R	Page
HN Female		PE9360	C1	30
HN Female	(PM)	PE9553	D1	30
HN Male		PE9194	B1	30
LC Female		PE9298	A2	30
LC Male		PE9237	E1	30
MCX Jack		PE9462	C2	30
MCX Plug		PE9463	B2	30
Mini UHF Male		PE9183	D2	30
QD 4.3-10 Female	(LP) (QD)	PE91482	B7	20
QD 4.3-10 Male	(LP) (QD)	PE91478	E5	20
Reverse Polarity SMA Male		PE9732	C1	38
Reverse Polarity TNC Male		PE9731	D6	30
SC Female		PE9292	A3	30
SC Male		PE9277	E2	30
SMA Female		PE9083	D5	36
SMA Female	(P)	PE9432	E5	36
SMA Female	(B)	PE9252	A6	36
SMA Female	(B) (P)	PE9486	B6	36
SMA Female	(PM)	PE9104	C6	36
SMA Female	(P) (PM)	PE9434	D6	36
SMA Female	(B)	PE9408	E6	36
SMA Female	(B) (P)	PE9435	A7	36
SMA Male	(LP)	PE91178	B3	30
SMA Male		PE9082	D4	34
SMA Male	(P)	PE9433	E4	34
SMA Male	(B) (P)	PE9487	A5	34
SMA Male	(PM)	PE9105	B5	34
SMA Male	(P) (PM)	PE9497	C5	34
SMA Male	(B) (P)	PE9488	D5	34
SMB Jack		PE9315	D3	30
SMB Plug		PE9316	C3	30
SMC Jack		PE9319	A4	30
SMC Plug		PE9320	E3	30
SSMA Female		PE9354	D1	40
TNC Female		PE9131	E4	30
TNC Female	(P)	PE9449	A5	30
TNC Female	(PM)	PE9552	B5	30
TNC Female	(B)	PE9482	C5	30
TNC Female	(P) (PM)	PE9450	D5	30
TNC Male		PE9089	B4	30
TNC Male	(P)	PE91506	C4	30
TNC Male	90°	PE9263	D4	30
UHF Female		PE9385	A6	30
UHF Male		PE9112	E5	30
<b>N In-Series:</b>				
Female to Female		PE91200	B6	27
Female to Female		PE91237	C6	27
Female to Female		PE9006	D6	27
Female to Female	(LP)	PE91140	E6	27
Female to Female		PE91141	A7	27
Female to Female	90°	PE9359	B7	27
Female to Female		PE9101	C7	27
Female to Female		PE9548	D7	27
Female to Female	(B)	PE9128	E7	27
Female to Female	(B)	PE9383	A1	28
Female to Female	(B) 90°	PE9541	B1	28
Female to Female	(PM)	PE9173	C1	28
Female to Female	(P) (PM)	PE9429	D1	28
Female to Female	(B)	PE91201	E1	28
Female to Female	(B)	PE91238	A2	28
Female to Female	(B) (LP)	PE91179	B2	28
Female to Female	(B) (P)	PE9500	C2	28
Female to Female	(B)	PE9382	D2	28
Female to Male		PE9350	E5	27
Female to Male		PE9102	A6	27
Female to Male		PE91199	D3	27
Female to Male		PE91236	E3	27
Female to Male	(LP)	PE91040	A4	27
Female to Male	(PO)	PE91114	B4	27
Female to Male		PE9311	C4	27
Female to Male		PE9349	D4	27
Female to Male	(QD)	PE9547	E4	27
Female to Male	(P) (R)	PE91350	A5	27
Female to Male	90°	PE9086	B5	27
Female to Male		PE9481	C5	27
Female to Male	(B)	PE9595	D5	27
Female to Male		PE91198	C2	27
Female to Male		PE91235	D2	27
Female to Male		PE9007	E2	27
Female to Male	(LP)	PE91034	A3	27
Female to Male	90°	PE9198	B3	27
Female to Male		PE9390	C3	27
<b>N Male To:</b>				
1.85mm Female		PE9720	D5	16
1.85mm Male		PE9718	E4	16
2.4mm Female	(P)	PE9503	A3	17
2.4mm Male	(P)	PE9504	E1	17
2.92mm Female	(P)	PE9663	C5	18
2.92mm Male	(P)	PE9661	A2	18
3.5mm Female	(P)	PE9321	A4	19
3.5mm Male	(P)	PE9322	B2	19
4.1/9.5 Mini DIN Female		PE91219	D1	20
4.1/9.5 Mini DIN Female		PE91256	E1	20
4.1/9.5 Mini DIN Female	(LP)	PE91094	A2	20
4.1/9.5 Mini DIN Male		PE91216	C7	19
4.1/9.5 Mini DIN Male		PE91253	D7	19
4.1/9.5 Mini DIN Male	(LP)	PE91092	E7	19

Connector Type	Feature	Model No.	C/R	Page
4.3-10 Female	(LP)	PE91388	A4	28
4.3-10 Female	(LP)	PE91479	D6	20
4.3-10 Male	(LP)	PE91476	A5	20
7/16 DIN Female	(LP)	PE91032	D4	28
7/16 DIN Female		PE91134	E4	28
7/16 DIN Female		PE91214	B3	22
7/16 DIN Female		PE91251	C3	22
7/16 DIN Male	(LP)	PE91030	B4	28
7/16 DIN Male		PE9535	C4	28
7/16 DIN Male		PE91211	C6	21
7/16 DIN Male		PE91248	D6	21
75 Ohm F Female		PE9155	A7	28
7mm Sexless	(P)	PE9217	E3	28
BNC Female		PE9002	D5	28
BNC Female	(P)	PE9491	E5	28
BNC Female	90°	PE9278	A6	28
BNC Female	(PM)	PE9388	B6	28
BNC Male		PE9127	A5	28
BNC Male	(P)	PE9489	B5	28
BNC Male	90°	PE9565	C5	28
C Female		PE91446	D6	28
C Female	90°	PE9239	E6	28
C Male		PE9538	C6	28
FME Plug		PE9704	B7	28
GR874 Sexless		PE9257	C7	28
HN Female		PE9125	E7	28
HN Male		PE9554	D7	28
LC Female		PE9299	A1	29
MCX Jack		PE9464	C1	29
MCX Plug		PE9465	B1	29
Mini UHF Female		PE9064	D1	29
QD 4.3-10 Female	(LP) (QD)	PE91481	E6	20
QD 4.3-10 Male	(LP) (QD)	PE91480	B5	20
QMA Female		PE9787	E1	29
Reverse Polarity SMA Female		PE9733	A2	38
Reverse Polarity TNC Female		PE9730	C6	30
SC Female		PE9196	B2	29
SC Male		PE9570	A2	29
SMA Female	(LP)	PE91177	C2	29
SMA Female		PE9081	D4	36
SMA Female	(B)	PE9551	A5	36
SMA Female	(PM)	PE9275	B5	36
SMA Female	(P) (PM)	PE9498	C5	36
SMA Male		PE9080	A4	34
SMA Male	(P)	PE9431	B4	34
SMA Male	(P) (PM)	PE9499	C4	34
SMB Jack		PE9313	E2	29
SMB Plug		PE9314	D2	29
SMC Jack		PE9317	B3	29
SMC Plug		PE9318	A3	29
SSMA Female		PE9352	C1	40
SSMA Male		PE9351	E7	39
TNC Female		PE9090	E3	29
TNC Female	(P)	PE9448	A4	29
TNC Female	90°	PE9550	B4	29
TNC Male		PE9130	C3	29
TNC Male	(P)	PE9446	D3	29
UHF Female		PE9111	D4	29
UHF Male		PE9113	C4	29
<b>Push-On SMA Male To:</b>				
SMA Female	(PO)	PE91336	E5	34
<b>Push-On SMP Female To:</b>				
Snap-On MMBX Plug	(PO) (SO)	PE91364	C5	39
<b>QD 4.3-10 Female To:</b>				
7/16 DIN Female	(LP) (QD)	PE91473	E2	22
N Female	(LP) (QD)	PE91482	B7	20
N Male	(LP) (QD)	PE91481	E6	20
<b>QD 4.3-10 Male To:</b>				
7/16 DIN Female	(LP) (QD)	PE91472	B2	22
N Female	(LP) (QD)	PE91478	E5	20
N Male	(LP) (QD)	PE91480	B5	20
<b>QD N Male To:</b>				
SMA Female	(QD)	PE9684	E4	36
<b>QMA Female To:</b>				
N Male		PE9787	E1	29
<b>QMA In-Series:</b>				
Female to Female	(SO)	PE91343	C7	30
Male to Female	(SO)	PE91342	B7	30
Male to Male	(SO)	PE91341	A7	30
<b>QMA Male To:</b>				
SMA Female		PE9786	B7	36
<b>Reverse Polarity BNC In-Series:</b>				
Female to Male		PE9529	D4	23
Male to Female		PE9530	C4	23
<b>Reverse Polarity MCX Plug To:</b>				
SMA Male		PE9581	D7	37
<b>Reverse Polarity N In-Series:</b>				
Female to Female		PE9773	C3	28
Female to Male		PE9770	B3	28
Male to Female		PE9771	A3	28
<b>Reverse Polarity SMA Female To:</b>				
N Male		PE9733	A2	38
Reverse Polarity TNC Female		PE9606	B3	38

Feature: (B) Bulkhead Mount / (H) Hermetically Sealed / (I) Isolated Sealed / (LP) Low PIM / (P) Precision / (PM) Panel Mount / (PO) Push On / (QD) Quick Disconnect / (R) Radius Right Angle / (RU) Ruggedized / (SO) Snap-On



Technical Support  
+1 (949) 261-1920



Same-Day Shipping,  
Even Custom  
Cable Assemblies

# Adapter Locator

Connector Type	Feature	Model No.	C/R	Page	Connector Type	Feature	Model No.	C/R	Page	Connector Type	Feature	Model No.	C/R	Page
Reverse Polarity TNC Male		PE9607	A3	38	1.85mm Female		PE9729	C4	35	TNC Male		PE9440	E5	37
TNC Female		PE9599	C2	38	1.85mm Male		PE9726	B4	35	UHF Male		PE9415	E6	37
TNC Male		PE9598	B2	38	2.4mm Female (P)		PE9656	E4	35	UMCX Jack		PE91006	B7	37
<b>Reverse Polarity SMA In-Series:</b>					2.4mm Male		PE9655	D4	35	UMCX Plug		PE91005	A7	37
Female to Female		PE91260	E7	32	2.4mm NMD Female (RU)		PE91146	B4	17	<b>SMA In-Series:</b>				
Female to Female		PE91262	D2	33	2.92mm Female (P)		PE91011	B5	35	Female to Female		PE9070	C3	32
Female to Female		PE91334	E2	33	2.92mm Male (P)		PE91009	A5	35	Female to Female		PE9380	D3	32
Female to Female		PE9593	A3	33	3.5mm Female		PE9725	D5	35	Female to Female (P)		PE9507	E3	32
Female to Female (B)		PE9593	A3	33	3.5mm Male		PE9724	C5	35	Female to Female (P)		PE9695	A4	32
Female to Female (PM)		PE91270	B3	33	3.5mm NMD Female (RU)		PE91147	E4	19	Female to Female (P)		PE9485	B4	32
Female to Female (PM)		PE91269	C3	33	4.3-10 Male		PE91484	C6	20	Female to Female (P)		PE9246	C4	32
Female to Male		PE9533	D7	32	7/16 DIN Female (LP)		PE91042	D6	35	Female to Female (B)		PE91258	D4	32
Male to Female (QD)		PE91265	A7	32	7/16 DIN Male (LP)		PE91036	B6	35	Female to Female (B)		PE9508	E4	32
Male to Female		PE9534	B7	32	7/16 DIN Male (LP)		PE91175	C6	35	Female to Female (B) (P)		PE9620	A5	32
Male to Female		PE91264	C7	32	75 Ohm F Female		PE91002	B1	36	Female to Female (H) (B)		PE91393	B5	32
Male to Female (QD)		PE91267	B1	33	75 Ohm F Male		PE91045	A1	36	Female to Female (B)		PE9184	C5	32
Male to Female		PE91263	C1	33	7mm Sexless (P)		PE9214	E5	35	Female to Female (B)		PE9067	D5	32
Male to Female (QD)		PE91268	A2	33	7mm Sexless (P) (PM)		PE9327	A6	35	Female to Female (PM)		PE9312	E5	32
Male to Female		PE91331	B2	33	BNC Female		PE9075	B7	35	Female to Female (PM)		PE9670	A6	32
Male to Female		PE9594	C2	33	BNC Female		PE9496	C7	35	Female to Female (B)		PE9184NH	B6	32
Male to Female		PE91259	E6	32	BNC Female (B)		PE9185	D7	35	Female to Female (PM)		PE91290	C6	32
Male to Male (QD)		PE91266	A1	33	BNC Female (B)		PE9407	E7	35	Female to Female		PE9182	B3	32
Male to Male		PE91261	D1	33	BNC Male		PE9073	E6	35	Male to Female		PE9103	A7	31
Male to Male		PE91330	E1	33	BNC Male		PE9494	A7	35	Male to Female (QD)		PE9546	B7	31
<b>Reverse Polarity SMA Male To:</b>					BNC Male		PE9708	D1	36	Male to Female (P)		PE9694	C7	31
N Female		PE9732	C1	38	FME Jack		PE9703	C1	36	Male to Female (P) (QD)		PE9774	D7	31
Reverse Polarity TNC Female		PE9604	E2	38	FME Plug					Male to Female (R)		PE91492	E7	31
Reverse Polarity TNC Male		PE9605	D2	38	Full Detent Mini SMP Male		PE91299	E2	36	Male to Female (R)		PE91493	A1	32
TNC Female		PE9596	E1	38	Full Detent Mini SMP Male		PE91129	A3	36	Male to Female (R)		PE91155	B1	32
TNC Male		PE9597	D1	38	Full Detent SMP Male		PE91305	B1	37	Male to Female (R)		PE91222	C1	32
<b>Reverse Polarity TNC Female To:</b>					Full Detent SMP Male (P)		PE91056	C1	37	Male to Female (R)		PE9068	D1	32
BNC Male		PE91087	D1	42	Full Detent SMP Male (B)		PE91054	D1	37	Male to Female (P) 45°		PE91332	E1	32
N Male		PE9730	C6	30	Full Detent SMP Male (P) (PM)		PE91058	E1	37	Male to Female		PE91149	B2	32
Reverse Polarity SMA Female		PE9606	B3	38	GR874 Sexless		PE9260	E1	36	Male to Female (P) 90°		PE91504	C2	32
Reverse Polarity SMA Male		PE9604	E2	38	HN Female		PE9255	B2	36	Male to Female (B)		PE9014	D2	32
SMA Female		PE9603	B1	38	HN Male		PE9253	A2	36	Male to Female (B)		PE9621	E2	32
SMA Male		PE9600	E7	37	Limited Detent SMP Male		PE91306	A2	37	Male to Female (B) (PO)		PE91321	A3	32
<b>Reverse Polarity TNC In-Series:</b>					Limited Detent SMP Male (P)		PE91050	B2	37	Male to Male		PE91135	B5	31
Female to Male		PE9531	D2	41	Limited Detent SMP Male (P)		PE9512	C2	37	Male to Male (P)		PE9505	C5	31
Male to Female		PE9532	C2	41	Limited Detent SMP Male (P)		PE9778	D2	37	Male to Male (R)		PE91327	D5	31
Male to Female 90°		PE9918	E2	41	Limited Detent SMP Male (P) (PM)		PE91066	E2	37	Male to Male (P) (R)		PE91458	E5	31
<b>Reverse Polarity TNC Male To:</b>					Limited Detent SMP Male		PE9470	D2	36	Male to Male 90°		PE9418	A6	31
N Female		PE9731	D6	30	MCX Jack		PE9471	C2	36	Male to Male		PE9379	B6	31
Reverse Polarity SMA Female		PE9607	A3	38	MCX Plug		PE9471	C2	36	Male to Male (P) 90°		PE91151	C6	31
Reverse Polarity SMA Male		PE9605	D2	38	Mini SMP Female		PE91301	C3	36	Male to Male (R) 90°		PE9642	D6	31
SMA Female		PE9602	A1	38	Mini SMP Female (P)		PE91051	D3	36	Male to Male (PM)		PE9669	E6	31
<b>Reverse Thread SMA In-Series:</b>					MMCX Jack		PE9477	A4	36	<b>SMA Male To:</b>				
Female to Male		PE9683	A4	33	MMCX Plug		PE9475	E3	36	1.0/2.3 Jack		PE9690	D4	33
Male to Female		PE9682	E3	33	N Female		PE9083	D5	36	1.0/2.3 Plug		PE9692	C4	33
<b>SC Female To:</b>					N Female (P)		PE9432	E5	36	1.85mm Female		PE9728	A5	33
7/16 DIN Male		PE91444	B7	21	N Female (B)		PE9252	A6	36	1.85mm Male		PE9727	E4	33
BNC Female		PE9571	D3	31	N Female (B) (P)		PE9486	B6	36	2.4mm Female (P)		PE9654	C5	33
N Female		PE9292	A3	30	N Female (PM)		PE9104	C6	36	2.4mm Male (P)		PE9653	B5	33
N Male		PE9196	B2	29	N Female (P) (PM)		PE9434	D6	36	2.92mm Female (P)		PE91008	E5	33
<b>SC In-Series:</b>					N Female (B)		PE9408	E6	36	2.92mm Male (P)		PE91010	D5	33
Female to Female		PE9404	D2	31	N Female (B) (P)		PE9435	A7	36	3.5mm Male		PE9722	A6	33
Female to Female (B)		PE9573	E2	31	N Male		PE9081	D4	36	7/16 DIN Female (LP)		PE91041	D6	33
Female to Male		PE9225	C2	31	N Male (B)		PE9551	A5	36	7/16 DIN Female (LP)		PE91043	E6	33
Male to Female		PE9572	A2	31	N Male (PM)		PE9275	B5	36	7/16 DIN Male (LP)		PE91003	E7	33
Male to Female		PE9405	B2	31	N Male (P) (PM)		PE9498	C5	36	75 Ohm F Female (P)		PE9215	B6	33
Male to Male		PE9403	E1	31	N Male (LP)		PE91177	C2	29	7mm Sexless		PE9074	C7	33
<b>SC Male To:</b>					N Male (PO)		PE91336	E5	34	BNC Female		PE9495	D7	33
BNC Female		PE9200	C3	31	QD N Male (QD)		PE9684	E4	36	BNC Male		PE9072	A7	33
BNC Male		PE9568	B3	31	QMA Male		PE9786	B7	36	BNC Male		PE9493	B7	33
N Female		PE9277	E2	30	Reverse Polarity TNC Female		PE9603	B1	38	FME Jack		PE9707	A1	34
N Male		PE9570	A2	29	Reverse Polarity TNC Male		PE9602	A1	38	Full Detent Mini SMP Male		PE91302	B2	34
<b>SHV In-Series:</b>					Slide-On BMA Jack		PE91400	A1	23	Full Detent Mini SMP Male (P)		PE91052	D2	34
Jack to Jack		PE9337	D4	31	Slide-On BMA Jack (PM)		PE91399	B1	23	Full Detent SMP Male		PE91309	E6	34
Jack to Jack (B)		PE9336	E4	31	Slide-On BMA Plug		PE91398	C7	22	Full Detent SMP Male (P)		PE91063	C7	34
Jack to Plug		PE9249	C4	31	Slide-On BMA Plug (B)		PE91402	D7	22	GR874 Sexless		PE9259	B1	34
Plug to Jack		PE9749	A4	31	SMB Jack		PE9143	D7	36	HN Female		PE9256	D1	34
Plug to Jack 90°		PE9338	B4	31	SMB Plug		PE9142	C7	36	HN Male		PE91448	C1	34
MHV Female		PE9339	C2	26	SMB Jack		PE9147	A1	37	Limited Detent SMP Male		PE91310	A7	34
MHV Male		PE9335	A2	26	SMB Plug		PE9146	E7	36	Limited Detent SMP Male (P)		PE9511	D7	34
<b>SHV Plug To:</b>					Smooth Bore Mini SMP Male		PE91300	B3	36	MCX Jack		PE9472	A2	34
MHV Female		PE9265	B2	26	Smooth Bore SMP Male (P)		PE91307	A3	37	MCX Plug		PE9473	E1	34
MHV Male		PE9340	E1	26	Smooth Bore SMP Male (P) (PM)		PE91049	B3	37	Mini SMP Female		PE91304	E2	34
<b>Slide-On BMA Jack To:</b>					SMP Female		PE91081	C3	37	Mini SMP Female (P)		PE91103	A3	34
SMA Female		PE91400	A1	23	SMP Female (P)		PE91308	A4	37	MMCX Jack		PE9478	C3	34
SMA Female (PM)		PE91399	B1	23	SMP Female (P)		PE91064	B4	37	MMCX Plug		PE9476	B3	34
SMA Male		PE91397	E7	22	SMP Female (P) (PM)		PE9779	A4	37	N Female (P)		PE9082	D4	34
<b>Slide-On BMA Plug To:</b>					SMP Male		PE91057	D3	37	N Female (B) (P)		PE9487	A5	34
SMA Female		PE91398	C7	22	SMP Male (P) (PM)		PE91059	E3	37	N Female (PM)		PE91005	B5	34
SMA Female (B)		PE91402	D7	22	Snap-On MMBX Jack (SO)		PE91363	C4	36	N Female (P) (PM)		PE9497	C5	34
SMA Male		PE91396	A7	22	Snap-On MMBX Plug (SO)		PE91361	B4	36	N Female (B) (P)		PE9488	D5	34
SMA Male (B)		PE91401	B7	22	Snap-On QMA Male (SO)		PE91345	A1	31	N Female (LP)		PE91178	B3	30
<b>SMA Female To:</b>					SSMA Female		PE9399	E4	37	N Male		PE9080	A4	34
1.0/2.3 Jack		PE9693	A4	35	SSMA Male		PE9188	D4	37	N Male (P)		PE9431	B4	34
1.0/2.3 Plug		PE9691	E3	35	SSMB Plug		PE9402	A5	37	N Male (P) (PM)		PE9499	C4	34
					SSMC Jack		PE91433	C5	37	Reverse Polarity MCX Plug		PE9581	D7	37
					SSMC Plug		PE91380	B5	37	Reverse Polarity TNC Female		PE9600	E7	37
					TNC Female		PE9079	A6	37					
					TNC Female (B)		PE9442	B6	37					
					TNC Female (PM)		PE9251	C6	37					
					TNC Male		PE9276	D6	37					
							PE9077	D5	37					



# Adapter Locator

Adapters

Connector Type	Feature	Model No.	C/R	Page
Slide-On BMA Jack		<a href="#">PE91397</a>	E7	<a href="#">22</a>
Slide-On BMA Plug		<a href="#">PE91396</a>	A7	<a href="#">22</a>
Slide-On BMA Plug	(B)	<a href="#">PE91401</a>	B7	<a href="#">22</a>
SMB Jack		<a href="#">PE9145</a>	B6	<a href="#">34</a>
SMB Plug		<a href="#">PE9144</a>	A6	<a href="#">34</a>
SMC Jack		<a href="#">PE9149</a>	D6	<a href="#">34</a>
SMC Plug		<a href="#">PE9148</a>	C6	<a href="#">34</a>
Smooth Bore Mini SMP Male		<a href="#">PE91303</a>	C2	<a href="#">34</a>
Smooth Bore SMP Male		<a href="#">PE91311</a>	B7	<a href="#">34</a>
SMP Female		<a href="#">PE91312</a>	E7	<a href="#">34</a>
SMP Female	(P)	<a href="#">PE91062</a>	A1	<a href="#">35</a>
SMP Female	(P)	<a href="#">PE9513</a>	B1	<a href="#">35</a>
Snap-On MMBX Jack	(SO)	<a href="#">PE91362</a>	E3	<a href="#">35</a>
Snap-On MMBX Plug	(SO)	<a href="#">PE91360</a>	D3	<a href="#">34</a>
Snap-On QMA Female	(SO)	<a href="#">PE91346</a>	B1	<a href="#">31</a>
SSMA Female		<a href="#">PE9063</a>	D1	<a href="#">35</a>
SSMA Male		<a href="#">PE9187</a>	C1	<a href="#">35</a>
SSMB Jack		<a href="#">PE9401</a>	E1	<a href="#">35</a>
TNC Female		<a href="#">PE9078</a>	C2	<a href="#">35</a>
TNC Female		<a href="#">PE91507</a>	E2	<a href="#">35</a>
TNC Female	(PM)	<a href="#">PE9384</a>	B3	<a href="#">35</a>
TNC Male		<a href="#">PE9076</a>	A2	<a href="#">35</a>
TNC Male		<a href="#">PE9439</a>	B2	<a href="#">35</a>
UHF Female		<a href="#">PE9400</a>	C3	<a href="#">35</a>
UMCX Jack		<a href="#">PE91007</a>	D3	<a href="#">35</a>
<b>SMB In-Series:</b>				
Jack to Jack		<a href="#">PE9116</a>	D4	<a href="#">38</a>
Jack to Jack		<a href="#">PE9302</a>	E4	<a href="#">38</a>
Jack to Jack	(B)	<a href="#">PE9122</a>	A5	<a href="#">38</a>
Jack to Plug		<a href="#">PE9243</a>	C4	<a href="#">38</a>
Plug to Jack		<a href="#">PE9120</a>	A4	<a href="#">38</a>
Plug to Jack		<a href="#">PE9309</a>	B4	<a href="#">38</a>
Plug to Plug		<a href="#">PE9118</a>	D3	<a href="#">38</a>
Plug to Plug		<a href="#">PE9310</a>	E3	<a href="#">38</a>
<b>SMB Jack To:</b>				
BNC Female		<a href="#">PE9136</a>	B6	<a href="#">38</a>
BNC Female	(B)	<a href="#">PE9240</a>	C6	<a href="#">38</a>
BNC Male		<a href="#">PE9132</a>	A6	<a href="#">38</a>
N Female		<a href="#">PE9315</a>	D3	<a href="#">30</a>
N Male		<a href="#">PE9313</a>	E2	<a href="#">29</a>
SMA Female		<a href="#">PE9143</a>	D7	<a href="#">36</a>
SMA Male		<a href="#">PE9145</a>	B6	<a href="#">34</a>
SMC Jack		<a href="#">PE9283</a>	B3	<a href="#">39</a>
SMC Plug		<a href="#">PE9284</a>	B2	<a href="#">39</a>
<b>SMB Plug To:</b>				
BNC Female		<a href="#">PE9137</a>	D5	<a href="#">38</a>
BNC Female	(B)	<a href="#">PE9241</a>	E5	<a href="#">38</a>
BNC Male		<a href="#">PE9135</a>	C5	<a href="#">38</a>
N Female		<a href="#">PE9316</a>	C3	<a href="#">30</a>
N Male		<a href="#">PE9314</a>	D2	<a href="#">29</a>
SMA Female		<a href="#">PE9142</a>	C7	<a href="#">36</a>
SMA Male		<a href="#">PE9144</a>	A6	<a href="#">34</a>
SMC Jack		<a href="#">PE9282</a>	A3	<a href="#">39</a>
SMC Plug		<a href="#">PE9281</a>	A2	<a href="#">39</a>
<b>SMC In-Series:</b>				
Jack to Jack		<a href="#">PE9115</a>	E7	<a href="#">38</a>
Jack to Jack		<a href="#">PE9304</a>	A1	<a href="#">39</a>
Jack to Jack	(B) (PM)	<a href="#">PE91403</a>	B1	<a href="#">39</a>
Jack to Plug		<a href="#">PE9242</a>	D7	<a href="#">38</a>
Plug to Jack		<a href="#">PE9119</a>	B7	<a href="#">38</a>
Plug to Jack	90°	<a href="#">PE9303</a>	C7	<a href="#">38</a>
Plug to Plug		<a href="#">PE9117</a>	E6	<a href="#">38</a>
Plug to Plug		<a href="#">PE9305</a>	A7	<a href="#">38</a>
<b>SMC Jack To:</b>				
BNC Female		<a href="#">PE9140</a>	D2	<a href="#">39</a>
BNC Female	(B)	<a href="#">PE9108</a>	E2	<a href="#">39</a>
BNC Male		<a href="#">PE9138</a>	C2	<a href="#">39</a>
N Female		<a href="#">PE9319</a>	A4	<a href="#">30</a>
N Male		<a href="#">PE9317</a>	B3	<a href="#">29</a>
SMA Female		<a href="#">PE9147</a>	A1	<a href="#">37</a>
SMA Male		<a href="#">PE9149</a>	D6	<a href="#">34</a>
SMB Jack		<a href="#">PE9283</a>	B3	<a href="#">39</a>
SMB Plug		<a href="#">PE9282</a>	A3	<a href="#">39</a>
TNC Male		<a href="#">PE9226</a>	D5	<a href="#">41</a>
<b>SMC Plug To:</b>				
BNC Female		<a href="#">PE9141</a>	E1	<a href="#">39</a>
BNC Male		<a href="#">PE9139</a>	D1	<a href="#">39</a>
N Female		<a href="#">PE9320</a>	E3	<a href="#">30</a>
N Male		<a href="#">PE9318</a>	A3	<a href="#">29</a>
SMA Female		<a href="#">PE9146</a>	E7	<a href="#">36</a>
SMA Male		<a href="#">PE9148</a>	C6	<a href="#">34</a>
SMB Jack		<a href="#">PE9284</a>	B2	<a href="#">39</a>
SMB Plug		<a href="#">PE9281</a>	A2	<a href="#">39</a>
<b>Smooth Bore Mini SMP Male To:</b>				
2.92mm Female		<a href="#">PE91128</a>	A5	<a href="#">18</a>
2.92mm Male		<a href="#">PE91125</a>	D1	<a href="#">18</a>
SMA Female		<a href="#">PE91300</a>	B3	<a href="#">36</a>
SMA Male		<a href="#">PE91303</a>	C2	<a href="#">34</a>
<b>Smooth Bore SMP Male To:</b>				
SMA Female		<a href="#">PE91307</a>	A3	<a href="#">37</a>
SMA Female	(P)	<a href="#">PE91049</a>	B3	<a href="#">37</a>
SMA Female	(P) (PM)	<a href="#">PE91061</a>	C3	<a href="#">37</a>
SMA Male		<a href="#">PE91311</a>	B7	<a href="#">34</a>
<b>SMP Female To:</b>				
2.4mm Female		<a href="#">PE91055</a>	D3	<a href="#">17</a>
2.92mm Female		<a href="#">PE91060</a>	E5	<a href="#">18</a>

Connector Type	Feature	Model No.	C/R	Page
SMA Female		<a href="#">PE91308</a>	A4	<a href="#">37</a>
SMA Female	(P)	<a href="#">PE91064</a>	B4	<a href="#">37</a>
SMA Female	(P)	<a href="#">PE9779</a>	C4	<a href="#">37</a>
SMA Male		<a href="#">PE91312</a>	E7	<a href="#">34</a>
SMA Male	(P)	<a href="#">PE91062</a>	A1	<a href="#">35</a>
SMA Male	(P)	<a href="#">PE9513</a>	B1	<a href="#">35</a>
SMP Female		<a href="#">PE91065</a>	D5	<a href="#">39</a>
SMP Female		<a href="#">PE91065</a>	D5	<a href="#">39</a>
<b>SMP In-Series:</b>				
Female to Female		<a href="#">PE91102</a>	D3	<a href="#">39</a>
Female to Female		<a href="#">PE9776</a>	E3	<a href="#">39</a>
Female to Female		<a href="#">PE91068</a>	A4	<a href="#">39</a>
Female to Female		<a href="#">PE91072</a>	B4	<a href="#">39</a>
Female to Female		<a href="#">PE91099</a>	C4	<a href="#">39</a>
Female to Female		<a href="#">PE91101</a>	D4	<a href="#">39</a>
Female to Female		<a href="#">PE9775</a>	E4	<a href="#">39</a>
Female to Female		<a href="#">PE9777</a>	A5	<a href="#">39</a>
<b>SMP Male To:</b>				
2.4mm Female		<a href="#">PE91048</a>	C3	<a href="#">17</a>
SMA Female	(P) (PM)	<a href="#">PE91057</a>	D3	<a href="#">37</a>
SMA Female	(P) (PM)	<a href="#">PE91059</a>	E3	<a href="#">37</a>
<b>Snap-On MMBX Jack To:</b>				
SMA Female	(SO)	<a href="#">PE91363</a>	C4	<a href="#">36</a>
SMA Male	(SO)	<a href="#">PE91362</a>	E3	<a href="#">34</a>
<b>Snap-On MMBX Plug To:</b>				
Push-On SMP Female	(PO) (SO)	<a href="#">PE91364</a>	C5	<a href="#">39</a>
SMA Female	(SO)	<a href="#">PE91361</a>	B4	<a href="#">36</a>
SMA Male	(SO)	<a href="#">PE91360</a>	D3	<a href="#">34</a>
<b>Snap-On QMA Female To:</b>				
SMA Male	(SO)	<a href="#">PE91346</a>	B1	<a href="#">31</a>
Snap-On SMA Female	(SO)	<a href="#">PE91347</a>	C1	<a href="#">31</a>
<b>Snap-On QMA Male To:</b>				
SMA Female	(SO)	<a href="#">PE91345</a>	A1	<a href="#">31</a>
Snap-On SMA Male	(SO)	<a href="#">PE91344</a>	E7	<a href="#">30</a>
<b>Snap-On SMA Female To:</b>				
Snap-On QMA Female	(SO)	<a href="#">PE91347</a>	C1	<a href="#">31</a>
<b>Snap-On SMA Male To:</b>				
Snap-On QMA Male	(SO)	<a href="#">PE91344</a>	E7	<a href="#">30</a>
<b>SSMA Female To:</b>				
7mm Sexless	(P)	<a href="#">PE9356</a>	A1	<a href="#">40</a>
BNC Male		<a href="#">PE9191</a>	B1	<a href="#">40</a>
N Female		<a href="#">PE9354</a>	D1	<a href="#">40</a>
N Male		<a href="#">PE9352</a>	C1	<a href="#">40</a>
SMA Female		<a href="#">PE9399</a>	E4	<a href="#">37</a>
SMA Male		<a href="#">PE9063</a>	D1	<a href="#">35</a>
<b>SSMA In-Series:</b>				
Female to Female		<a href="#">PE9192</a>	E6	<a href="#">39</a>
Female to Female	(B)	<a href="#">PE9189</a>	A7	<a href="#">39</a>
Male to Female		<a href="#">PE9358</a>	B6	<a href="#">39</a>
Male to Female	(QD)	<a href="#">PE9685</a>	C6	<a href="#">39</a>
Male to Female	90°	<a href="#">PE9334</a>	D6	<a href="#">39</a>
Male to Male		<a href="#">PE9357</a>	A6	<a href="#">39</a>
<b>SSMA Male To:</b>				
2.92mm Female		<a href="#">PE9768</a>	A6	<a href="#">18</a>
BNC Female		<a href="#">PE91046</a>	D7	<a href="#">39</a>
BNC Male		<a href="#">PE9213</a>	C7	<a href="#">39</a>
N Male		<a href="#">PE9351</a>	E7	<a href="#">39</a>
SMA Female		<a href="#">PE9188</a>	D4	<a href="#">37</a>
SMA Male		<a href="#">PE9187</a>	C1	<a href="#">35</a>
<b>SSMB Jack To:</b>				
BNC Female		<a href="#">PE9394</a>	D2	<a href="#">40</a>
BNC Male		<a href="#">PE9392</a>	C2	<a href="#">40</a>
SMA Male		<a href="#">PE9401</a>	E1	<a href="#">35</a>
<b>SSMB Plug To:</b>				
BNC Female		<a href="#">PE9395</a>	B2	<a href="#">40</a>
BNC Male		<a href="#">PE9393</a>	A2	<a href="#">40</a>
SMA Female		<a href="#">PE9402</a>	A5	<a href="#">37</a>
<b>SSMC In-Series:</b>				
Jack to Jack	(B)	<a href="#">PE91432</a>	C3	<a href="#">40</a>
Plug to Jack		<a href="#">PE91434</a>	B3	<a href="#">40</a>
Plug to Plug		<a href="#">PE91436</a>	A3	<a href="#">40</a>
<b>SSMC Jack To:</b>				
SMA Female		<a href="#">PE91433</a>	C5	<a href="#">37</a>
<b>SSMC Plug To:</b>				
SMA Female		<a href="#">PE91380</a>	B5	<a href="#">37</a>
<b>TNC Female To:</b>				
7/16 DIN Female		<a href="#">PE91392</a>	B6	<a href="#">41</a>
7mm Sexless	(P)	<a href="#">PE9218</a>	A6	<a href="#">41</a>
BNC Female		<a href="#">PE9097</a>	D6	<a href="#">41</a>
BNC Male		<a href="#">PE9098</a>	C6	<a href="#">41</a>
C Male		<a href="#">PE9564</a>	E6	<a href="#">41</a>
FME Jack		<a href="#">PE9714</a>	A7	<a href="#">41</a>
Limited Detent SMP Male	(B)	<a href="#">PE91073</a>	A1	<a href="#">42</a>
MCX Jack		<a href="#">PE9544</a>	C7	<a href="#">41</a>
MCX Jack	(B)	<a href="#">PE9521</a>	D7	<a href="#">41</a>
MCX Plug		<a href="#">PE9545</a>	B7	<a href="#">41</a>
Mini UHF Male		<a href="#">PE9346</a>	E7	<a href="#">41</a>
N Female		<a href="#">PE9131</a>	E4	<a href="#">30</a>
N Female	(P)	<a href="#">PE9449</a>	A5	<a href="#">30</a>
N Female	(PM)	<a href="#">PE9552</a>	B5	<a href="#">30</a>
N Female	(B)	<a href="#">PE9482</a>	C5	<a href="#">30</a>
N Female	(P) (PM)	<a href="#">PE9450</a>	D5	<a href="#">30</a>
N Male		<a href="#">PE9090</a>	E3	<a href="#">29</a>
N Male	(P)	<a href="#">PE9448</a>	A4	<a href="#">29</a>
N Male	90°	<a href="#">PE9550</a>	B4	<a href="#">29</a>

Connector Type	Feature	Model No.	C/R	Page
Reverse Polarity SMA Female		<a href="#">PE9599</a>	C2	<a href="#">38</a>
Reverse Polarity SMA Male		<a href="#">PE9596</a>	E1	<a href="#">38</a>
SMA Female		<a href="#">PE9079</a>	A6	<a href="#">37</a>
SMA Female		<a href="#">PE9442</a>	B6	<a href="#">37</a>
SMA Female	(B)	<a href="#">PE9251</a>	C6	<a href="#">37</a>
SMA Female	(PM)	<a href="#">PE9276</a>	D6	<a href="#">37</a>
SMA Male		<a href="#">PE9078</a>	C2	<a href="#">35</a>
SMA Male		<a href="#">PE91507</a>	E2	<a href="#">35</a>
SMA Male	(PM)	<a href="#">PE9384</a>	B3	<a href="#">35</a>
UHF Male		<a href="#">PE9372</a>	B1	<a href="#">42</a>
<b>TNC In-Series:</b>				
Female to Female		<a href="#">PE91204</a>	A7	<a href="#">40</a>
Female to Female		<a href="#">PE91241</a>	B7	<a href="#">40</a>
Female to Female		<a href="#">PE9098</a>	C7	<a href="#">40</a>
Female to Female	(LP)	<a href="#">PE91174</a>	D7	<a href="#">40</a>
Female to Female	(P)	<a href="#">PE9444</a>	E7	<a href="#">40</a>
Female to Female		<a href="#">PE91381</a>	A1	<a href="#">41</a>
Female to Female	(B)	<a href="#">PE9154</a>	B1	<a href="#">41</a>
Female to Female	(PM)	<a href="#">PE9288</a>	C1	<a href="#">41</a>
Female to Female	(B)	<a href="#">PE91205</a>	D1	<a href="#">41</a>
Female to Female	(B)	<a href="#">PE91242</a>	E1	<a href="#">41</a>
Female to Female	(B)	<a href="#">PE9287</a>	A2	<a href="#">41</a>
Female to Male		<a href="#">PE9195</a>	E6	<a href="#">40</a>
Male to Female		<a href="#">PE91203</a>	A5	<a href="#">40</a>
Male to Female		<a href="#">PE91240</a>	B5	<a href="#">40</a>
Male to Female	(P)	<a href="#">PE91505</a>	C5	<a href="#">40</a>
Male to Female	(LP)	<a href="#">PE91173</a>	D5	<a href="#">40</a>
Male to Female		<a href="#">PE9270</a>	E5	<a href="#">40</a>
Male to Female		<a href="#">PE9443</a>	A6	<a href="#">40</a>
Male to Female	(QD)	<a href="#">PE9561</a>	B6	<a href="#">40</a>
Male to Female	90°	<a href="#">PE9100</a>	C6	<a href="#">40</a>
Male to Female		<a href="#">PE9290</a>	D6	<a href="#">40</a>
Male to Male	(LP)	<a href="#">PE91172</a>	E3	<a href="#">40</a>
Male to Male		<a href="#">PE91202</a>	A4	<a href="#">40</a>
Male to Male		<a href="#">PE91239</a>	B4	<a href="#">40</a>
Male to Male		<a href="#">PE9091</a>	C4	<a href="#">40</a>
Male to Male		<a href="#">PE9445</a>	D4	<a href="#">40</a>
Male to Male	90°	<a href="#">PE9560</a>	E4	<a href="#">40</a>
<b>TNC Male To:</b>				
7/16 DIN Female		<a href="#">PE9638</a>	C3	<a href="#">41</a>
7mm Sexless	(P)	<a href="#">PE9219</a>	B3	<a href="#">41</a>
BNC Female		<a href="#">PE9088</a>	D3	<a href="#">41</a>
BNC Female	90°	<a href="#">PE9783</a>	E3	<a href="#">41</a>
C Female		<a href="#">PE9562</a>	A4	<a href="#">41</a>
FME Jack		<a href="#">PE9713</a>	D4	<a href="#">41</a>
FME Plug		<a href="#">PE9699</a>	B4	<a href="#">41</a>
FME Plug	90°	<a href="#">PE9700</a>	C4	<a href="#">41</a>
HN Male		<a href="#">PE9563</a>	E4	<a href="#">41</a>
MCX Jack		<a href="#">PE9542</a>	B5	<a href="#">41</a>
MCX Plug		<a href="#">PE9543</a>	A5	<a href="#">41</a>
Mini UHF Female		<a href="#">PE9345</a>	C5	<a href="#">41</a>
N Female		<a href="#">PE9089</a>	B4	<a href="#">30</a>
N Female	(P)	<a href="#">PE91506</a>	C4	<a href="#">30</a>
N Female	90°	<a href="#">PE9263</a>	D4	<a href="#">30</a>
N Male		<a href="#">PE9130</a>	C3	<a href="#">29</a>
N Male	(P)	<a href="#">PE9446</a>	D3	<a href="#">29</a>
Reverse Polarity SMA Female		<a href="#">PE9598</a>	B2	<a href="#">38</a>
Reverse Polarity SMA Male		<a href="#">PE9597</a>	D1	<a href="#">38</a>
SMA Female		<a href="#">PE9077</a>	D5	<a href="#">37</a>
SMA Female		<a href="#">PE9440</a>	E5	<a href="#">37</a>
SMA Male		<a href="#">PE9076</a>	A2	<a href="#">35</a>
SMA Male		<a href="#">PE9439</a>	B2	<a href="#">35</a>































# LOW PIM ADAPTERS

See Adapter Locator on Pages 8-13

See Page 369 for Mounting Holes

Adapters



























See Our Website For Current Pricing & Real-Time Stock Availability!

	A	B	C	D	E																																																																											
1	<p><b>4.1/9.5 Mini DIN Between Series</b></p>  <table border="1"> <thead> <tr> <th colspan="3">PRICE</th> </tr> </thead> <tbody> <tr> <td>1-24</td> <td></td> <td>\$59.07</td> </tr> <tr> <td>25-49</td> <td></td> <td>\$56.12</td> </tr> <tr> <td>50-99</td> <td></td> <td>\$53.16</td> </tr> <tr> <td>100+</td> <td></td> <td>\$50.80</td> </tr> </tbody> </table> <p>Low PIM</p> <p>4.1/9.5 Mini DIN Male to N Male</p> <p>VSWR 1.25:1 to 6 GHz</p> <p>Model No: <a href="#">PE91092</a></p>	PRICE			1-24		\$59.07	25-49		\$56.12	50-99		\$53.16	100+		\$50.80	 <table border="1"> <thead> <tr> <th colspan="3">PRICE</th> </tr> </thead> <tbody> <tr> <td>1-24</td> <td></td> <td>\$57.46</td> </tr> <tr> <td>25-49</td> <td></td> <td>\$54.59</td> </tr> <tr> <td>50-99</td> <td></td> <td>\$51.71</td> </tr> <tr> <td>100+</td> <td></td> <td>\$49.42</td> </tr> </tbody> </table> <p>Low PIM</p> <p>4.1/9.5 Mini DIN Male to N Female</p> <p>VSWR 1.25:1 to 6 GHz</p> <p>Model No: <a href="#">PE91093</a></p>	PRICE			1-24		\$57.46	25-49		\$54.59	50-99		\$51.71	100+		\$49.42	 <table border="1"> <thead> <tr> <th colspan="3">PRICE</th> </tr> </thead> <tbody> <tr> <td>1-24</td> <td></td> <td>\$59.07</td> </tr> <tr> <td>25-49</td> <td></td> <td>\$56.12</td> </tr> <tr> <td>50-99</td> <td></td> <td>\$53.16</td> </tr> <tr> <td>100+</td> <td></td> <td>\$50.80</td> </tr> </tbody> </table> <p>Low PIM</p> <p>4.1/9.5 Mini DIN Female to N Male</p> <p>VSWR 1.25:1 to 6 GHz</p> <p>Model No: <a href="#">PE91094</a></p>	PRICE			1-24		\$59.07	25-49		\$56.12	50-99		\$53.16	100+		\$50.80	 <table border="1"> <thead> <tr> <th colspan="3">PRICE</th> </tr> </thead> <tbody> <tr> <td>1-24</td> <td></td> <td>\$59.07</td> </tr> <tr> <td>25-49</td> <td></td> <td>\$56.12</td> </tr> <tr> <td>50-99</td> <td></td> <td>\$53.16</td> </tr> <tr> <td>100+</td> <td></td> <td>\$50.80</td> </tr> </tbody> </table> <p>Low PIM</p> <p>4.1/9.5 Mini DIN Female to N Female</p> <p>VSWR 1.25:1 to 6 GHz</p> <p>Model No: <a href="#">PE91095</a></p>	PRICE			1-24		\$59.07	25-49		\$56.12	50-99		\$53.16	100+		\$50.80																
PRICE																																																																																
1-24		\$59.07																																																																														
25-49		\$56.12																																																																														
50-99		\$53.16																																																																														
100+		\$50.80																																																																														
PRICE																																																																																
1-24		\$57.46																																																																														
25-49		\$54.59																																																																														
50-99		\$51.71																																																																														
100+		\$49.42																																																																														
PRICE																																																																																
1-24		\$59.07																																																																														
25-49		\$56.12																																																																														
50-99		\$53.16																																																																														
100+		\$50.80																																																																														
PRICE																																																																																
1-24		\$59.07																																																																														
25-49		\$56.12																																																																														
50-99		\$53.16																																																																														
100+		\$50.80																																																																														
2	<p><b>4.3 Non Constant In-Series</b></p>  <table border="1"> <thead> <tr> <th colspan="3">PRICE</th> </tr> </thead> <tbody> <tr> <td>1-24</td> <td></td> <td>\$35.12</td> </tr> <tr> <td>25-49</td> <td></td> <td>\$33.36</td> </tr> <tr> <td>50-99</td> <td></td> <td>\$31.61</td> </tr> <tr> <td>100+</td> <td>NEW</td> <td>\$30.20</td> </tr> </tbody> </table> <p>Low PIM</p> <p>4.3-10 Male to 4.3-10 Male</p> <p>VSWR 1.25:1 to 6 GHz</p> <p>Model No: <a href="#">PE91466</a></p>	PRICE			1-24		\$35.12	25-49		\$33.36	50-99		\$31.61	100+	NEW	\$30.20	 <table border="1"> <thead> <tr> <th colspan="3">PRICE</th> </tr> </thead> <tbody> <tr> <td>1-24</td> <td></td> <td>\$80.00</td> </tr> <tr> <td>25-49</td> <td></td> <td>\$76.00</td> </tr> <tr> <td>50-99</td> <td></td> <td>\$72.00</td> </tr> <tr> <td>100+</td> <td>NEW</td> <td>\$68.80</td> </tr> </tbody> </table> <p>Low PIM</p> <p>4.3-10 Male to 4.3-10 Male</p> <p>VSWR 1.08:1 to 6 GHz</p> <p>Model No: <a href="#">PE91385</a></p>	PRICE			1-24		\$80.00	25-49		\$76.00	50-99		\$72.00	100+	NEW	\$68.80	 <table border="1"> <thead> <tr> <th colspan="3">PRICE</th> </tr> </thead> <tbody> <tr> <td>1-24</td> <td></td> <td>\$39.69</td> </tr> <tr> <td>25-49</td> <td></td> <td>\$37.71</td> </tr> <tr> <td>50-99</td> <td></td> <td>\$35.72</td> </tr> <tr> <td>100+</td> <td>NEW</td> <td>\$34.13</td> </tr> </tbody> </table> <p>Low PIM</p> <p>4.3-10 Male to 4.3-10 Female</p> <p>VSWR 1.25:1 to 6 GHz</p> <p>Model No: <a href="#">PE91465</a></p>	PRICE			1-24		\$39.69	25-49		\$37.71	50-99		\$35.72	100+	NEW	\$34.13	 <table border="1"> <thead> <tr> <th colspan="3">PRICE</th> </tr> </thead> <tbody> <tr> <td>1-24</td> <td></td> <td>\$80.00</td> </tr> <tr> <td>25-49</td> <td></td> <td>\$76.00</td> </tr> <tr> <td>50-99</td> <td></td> <td>\$72.00</td> </tr> <tr> <td>100+</td> <td>NEW</td> <td>\$68.80</td> </tr> </tbody> </table> <p>Low PIM</p> <p>4.3-10 Male to 4.3-10 Female Right Angle</p> <p>VSWR 1.2:1 to 3 GHz</p> <p>Model No: <a href="#">PE91467</a></p>	PRICE			1-24		\$80.00	25-49		\$76.00	50-99		\$72.00	100+	NEW	\$68.80																
PRICE																																																																																
1-24		\$35.12																																																																														
25-49		\$33.36																																																																														
50-99		\$31.61																																																																														
100+	NEW	\$30.20																																																																														
PRICE																																																																																
1-24		\$80.00																																																																														
25-49		\$76.00																																																																														
50-99		\$72.00																																																																														
100+	NEW	\$68.80																																																																														
PRICE																																																																																
1-24		\$39.69																																																																														
25-49		\$37.71																																																																														
50-99		\$35.72																																																																														
100+	NEW	\$34.13																																																																														
PRICE																																																																																
1-24		\$80.00																																																																														
25-49		\$76.00																																																																														
50-99		\$72.00																																																																														
100+	NEW	\$68.80																																																																														
3	 <table border="1"> <thead> <tr> <th colspan="3">PRICE</th> </tr> </thead> <tbody> <tr> <td>1-24</td> <td></td> <td>\$81.02</td> </tr> <tr> <td>25-49</td> <td></td> <td>\$77.78</td> </tr> <tr> <td>50-99</td> <td></td> <td>\$75.35</td> </tr> <tr> <td>100+</td> <td></td> <td>\$73.73</td> </tr> </tbody> </table> <p>Low PIM</p> <p>4.3-10 Male to 4.3-10 Female</p> <p>VSWR 1.08:1 to 6 GHz</p> <p>Model No: <a href="#">PE91387</a></p>	PRICE			1-24		\$81.02	25-49		\$77.78	50-99		\$75.35	100+		\$73.73	 <table border="1"> <thead> <tr> <th colspan="3">PRICE</th> </tr> </thead> <tbody> <tr> <td>1-24</td> <td></td> <td>\$39.69</td> </tr> <tr> <td>25-49</td> <td></td> <td>\$37.71</td> </tr> <tr> <td>50-99</td> <td></td> <td>\$35.72</td> </tr> <tr> <td>100+</td> <td>NEW</td> <td>\$34.13</td> </tr> </tbody> </table> <p>Low PIM</p> <p>4.3-10 Female to 4.3-10 Female</p> <p>VSWR 1.25:1 to 6 GHz</p> <p>Model No: <a href="#">PE91464</a></p>	PRICE			1-24		\$39.69	25-49		\$37.71	50-99		\$35.72	100+	NEW	\$34.13	 <table border="1"> <thead> <tr> <th colspan="3">PRICE</th> </tr> </thead> <tbody> <tr> <td>1-24</td> <td></td> <td>\$82.65</td> </tr> <tr> <td>25-49</td> <td></td> <td>\$78.52</td> </tr> <tr> <td>50-99</td> <td></td> <td>\$74.39</td> </tr> <tr> <td>100+</td> <td>NEW</td> <td>\$71.08</td> </tr> </tbody> </table> <p>Low PIM</p> <p>4.3-10 Female to 4.3-10 Female</p> <p>VSWR 1.08:1 to 6 GHz</p> <p>Model No: <a href="#">PE91386</a></p>	PRICE			1-24		\$82.65	25-49		\$78.52	50-99		\$74.39	100+	NEW	\$71.08	<p><b>4.3 Non Constant Between Series</b></p>  <table border="1"> <thead> <tr> <th colspan="3">PRICE</th> </tr> </thead> <tbody> <tr> <td>1-24</td> <td></td> <td>\$35.12</td> </tr> <tr> <td>25-49</td> <td></td> <td>\$33.36</td> </tr> <tr> <td>50-99</td> <td></td> <td>\$31.61</td> </tr> <tr> <td>100+</td> <td>NEW</td> <td>\$30.20</td> </tr> </tbody> </table> <p>Low PIM</p> <p>4.3-10 Male to N Male</p> <p>VSWR 1.25:1 to 6 GHz</p> <p>Model No: <a href="#">PE91476</a></p>	PRICE			1-24		\$35.12	25-49		\$33.36	50-99		\$31.61	100+	NEW	\$30.20																
PRICE																																																																																
1-24		\$81.02																																																																														
25-49		\$77.78																																																																														
50-99		\$75.35																																																																														
100+		\$73.73																																																																														
PRICE																																																																																
1-24		\$39.69																																																																														
25-49		\$37.71																																																																														
50-99		\$35.72																																																																														
100+	NEW	\$34.13																																																																														
PRICE																																																																																
1-24		\$82.65																																																																														
25-49		\$78.52																																																																														
50-99		\$74.39																																																																														
100+	NEW	\$71.08																																																																														
PRICE																																																																																
1-24		\$35.12																																																																														
25-49		\$33.36																																																																														
50-99		\$31.61																																																																														
100+	NEW	\$30.20																																																																														
4	 <table border="1"> <thead> <tr> <th colspan="3">PRICE</th> </tr> </thead> <tbody> <tr> <td>1-24</td> <td></td> <td>\$48.00</td> </tr> <tr> <td>25-49</td> <td></td> <td>\$45.60</td> </tr> <tr> <td>50-99</td> <td></td> <td>\$43.20</td> </tr> <tr> <td>100+</td> <td>NEW</td> <td>\$41.28</td> </tr> </tbody> </table> <p>Low PIM</p> <p>QD 4.3-10 Male to N Male</p> <p>VSWR 1.25:1 to 6 GHz</p> <p>Model No: <a href="#">PE91480</a></p>	PRICE			1-24		\$48.00	25-49		\$45.60	50-99		\$43.20	100+	NEW	\$41.28	 <table border="1"> <thead> <tr> <th colspan="3">PRICE</th> </tr> </thead> <tbody> <tr> <td>1-24</td> <td></td> <td>\$35.12</td> </tr> <tr> <td>25-49</td> <td></td> <td>\$33.36</td> </tr> <tr> <td>50-99</td> <td></td> <td>\$31.61</td> </tr> <tr> <td>100+</td> <td>NEW</td> <td>\$30.20</td> </tr> </tbody> </table> <p>Low PIM</p> <p>4.3-10 Male to N Female</p> <p>VSWR 1.25:1 to 6 GHz</p> <p>Model No: <a href="#">PE91474</a></p>	PRICE			1-24		\$35.12	25-49		\$33.36	50-99		\$31.61	100+	NEW	\$30.20	 <table border="1"> <thead> <tr> <th colspan="3">PRICE</th> </tr> </thead> <tbody> <tr> <td>1-24</td> <td></td> <td>\$35.12</td> </tr> <tr> <td>25-49</td> <td></td> <td>\$33.36</td> </tr> <tr> <td>50-99</td> <td></td> <td>\$31.61</td> </tr> <tr> <td>100+</td> <td>NEW</td> <td>\$30.20</td> </tr> </tbody> </table> <p>Low PIM</p> <p>4.3-10 Male to N Female</p> <p>VSWR 1.25:1 to 6 GHz</p> <p>Model No: <a href="#">PE91477</a></p>	PRICE			1-24		\$35.12	25-49		\$33.36	50-99		\$31.61	100+	NEW	\$30.20	 <table border="1"> <thead> <tr> <th colspan="3">PRICE</th> </tr> </thead> <tbody> <tr> <td>1-24</td> <td></td> <td>\$46.20</td> </tr> <tr> <td>25-49</td> <td></td> <td>\$43.89</td> </tr> <tr> <td>50-99</td> <td></td> <td>\$41.58</td> </tr> <tr> <td>100+</td> <td>NEW</td> <td>\$39.73</td> </tr> </tbody> </table> <p>Low PIM</p> <p>QD 4.3-10 Male to N Female</p> <p>VSWR 1.25:1 to 6 GHz</p> <p>Model No: <a href="#">PE91478</a></p>	PRICE			1-24		\$46.20	25-49		\$43.89	50-99		\$41.58	100+	NEW	\$39.73	 <table border="1"> <thead> <tr> <th colspan="3">PRICE</th> </tr> </thead> <tbody> <tr> <td>1-24</td> <td></td> <td>\$56.45</td> </tr> <tr> <td>25-49</td> <td></td> <td>\$53.63</td> </tr> <tr> <td>50-99</td> <td></td> <td>\$50.81</td> </tr> <tr> <td>100+</td> <td>NEW</td> <td>\$48.55</td> </tr> </tbody> </table> <p>Low PIM</p> <p>4.3-10 Male to N Female Right Angle</p> <p>VSWR 1.25:1 to 6 GHz</p> <p>Model No: <a href="#">PE91483</a></p>	PRICE			1-24		\$56.45	25-49		\$53.63	50-99		\$50.81	100+	NEW	\$48.55
PRICE																																																																																
1-24		\$48.00																																																																														
25-49		\$45.60																																																																														
50-99		\$43.20																																																																														
100+	NEW	\$41.28																																																																														
PRICE																																																																																
1-24		\$35.12																																																																														
25-49		\$33.36																																																																														
50-99		\$31.61																																																																														
100+	NEW	\$30.20																																																																														
PRICE																																																																																
1-24		\$35.12																																																																														
25-49		\$33.36																																																																														
50-99		\$31.61																																																																														
100+	NEW	\$30.20																																																																														
PRICE																																																																																
1-24		\$46.20																																																																														
25-49		\$43.89																																																																														
50-99		\$41.58																																																																														
100+	NEW	\$39.73																																																																														
PRICE																																																																																
1-24		\$56.45																																																																														
25-49		\$53.63																																																																														
50-99		\$50.81																																																																														
100+	NEW	\$48.55																																																																														
5	 <table border="1"> <thead> <tr> <th colspan="3">PRICE</th> </tr> </thead> <tbody> <tr> <td>1-24</td> <td></td> <td>\$84.23</td> </tr> <tr> <td>25-49</td> <td></td> <td>\$80.02</td> </tr> <tr> <td>50-99</td> <td></td> <td>\$75.81</td> </tr> <tr> <td>100+</td> <td>NEW</td> <td>\$72.44</td> </tr> </tbody> </table> <p>Low PIM</p> <p>4.3-10 Male to N Female</p> <p>VSWR 1.08:1 to 6 GHz</p> <p>Model No: <a href="#">PE91389</a></p>	PRICE			1-24		\$84.23	25-49		\$80.02	50-99		\$75.81	100+	NEW	\$72.44	 <table border="1"> <thead> <tr> <th colspan="3">PRICE</th> </tr> </thead> <tbody> <tr> <td>1-24</td> <td></td> <td>\$34.63</td> </tr> <tr> <td>25-49</td> <td></td> <td>\$32.90</td> </tr> <tr> <td>50-99</td> <td></td> <td>\$31.17</td> </tr> <tr> <td>100+</td> <td>NEW</td> <td>\$29.78</td> </tr> </tbody> </table> <p>Low PIM</p> <p>4.3-10 Male to SMA Female</p> <p>VSWR 1.15:1 to 6 GHz</p> <p>Model No: <a href="#">PE91484</a></p>	PRICE			1-24		\$34.63	25-49		\$32.90	50-99		\$31.17	100+	NEW	\$29.78	 <table border="1"> <thead> <tr> <th colspan="3">PRICE</th> </tr> </thead> <tbody> <tr> <td>1-24</td> <td></td> <td>\$41.28</td> </tr> <tr> <td>25-49</td> <td></td> <td>\$39.22</td> </tr> <tr> <td>50-99</td> <td></td> <td>\$37.15</td> </tr> <tr> <td>100+</td> <td>NEW</td> <td>\$35.50</td> </tr> </tbody> </table> <p>Low PIM</p> <p>4.3-10 Female to N Male</p> <p>VSWR 1.25:1 to 6 GHz</p> <p>Model No: <a href="#">PE91479</a></p>	PRICE			1-24		\$41.28	25-49		\$39.22	50-99		\$37.15	100+	NEW	\$35.50	 <table border="1"> <thead> <tr> <th colspan="3">PRICE</th> </tr> </thead> <tbody> <tr> <td>1-24</td> <td></td> <td>\$38.93</td> </tr> <tr> <td>25-49</td> <td></td> <td>\$36.98</td> </tr> <tr> <td>50-99</td> <td></td> <td>\$35.04</td> </tr> <tr> <td>100+</td> <td>NEW</td> <td>\$33.48</td> </tr> </tbody> </table> <p>Low PIM</p> <p>QD 4.3-10 Female to N Male</p> <p>VSWR 1.25:1 to 6 GHz</p> <p>Model No: <a href="#">PE91481</a></p>	PRICE			1-24		\$38.93	25-49		\$36.98	50-99		\$35.04	100+	NEW	\$33.48	 <table border="1"> <thead> <tr> <th colspan="3">PRICE</th> </tr> </thead> <tbody> <tr> <td>1-24</td> <td></td> <td>\$35.88</td> </tr> <tr> <td>25-49</td> <td></td> <td>\$34.09</td> </tr> <tr> <td>50-99</td> <td></td> <td>\$32.29</td> </tr> <tr> <td>100+</td> <td>NEW</td> <td>\$30.86</td> </tr> </tbody> </table> <p>Low PIM</p> <p>4.3-10 Female to N Female</p> <p>VSWR 1.25:1 to 6 GHz</p> <p>Model No: <a href="#">PE91475</a></p>	PRICE			1-24		\$35.88	25-49		\$34.09	50-99		\$32.29	100+	NEW	\$30.86
PRICE																																																																																
1-24		\$84.23																																																																														
25-49		\$80.02																																																																														
50-99		\$75.81																																																																														
100+	NEW	\$72.44																																																																														
PRICE																																																																																
1-24		\$34.63																																																																														
25-49		\$32.90																																																																														
50-99		\$31.17																																																																														
100+	NEW	\$29.78																																																																														
PRICE																																																																																
1-24		\$41.28																																																																														
25-49		\$39.22																																																																														
50-99		\$37.15																																																																														
100+	NEW	\$35.50																																																																														
PRICE																																																																																
1-24		\$38.93																																																																														
25-49		\$36.98																																																																														
50-99		\$35.04																																																																														
100+	NEW	\$33.48																																																																														
PRICE																																																																																
1-24		\$35.88																																																																														
25-49		\$34.09																																																																														
50-99		\$32.29																																																																														
100+	NEW	\$30.86																																																																														
6	 <table border="1"> <thead> <tr> <th colspan="3">PRICE</th> </tr> </thead> <tbody> <tr> <td>1-24</td> <td></td> <td>\$38.72</td> </tr> <tr> <td>25-49</td> <td></td> <td>\$36.78</td> </tr> <tr> <td>50-99</td> <td></td> <td>\$34.85</td> </tr> <tr> <td>100+</td> <td>NEW</td> <td>\$33.30</td> </tr> </tbody> </table> <p>Low PIM</p> <p>QD 4.3-10 Female to N Female</p> <p>VSWR 1.25:1 to 6 GHz</p> <p>Model No: <a href="#">PE91482</a></p>	PRICE			1-24		\$38.72	25-49		\$36.78	50-99		\$34.85	100+	NEW	\$33.30	<p><b>7/16 DIN In-Series</b></p>  <table border="1"> <thead> <tr> <th colspan="3">PRICE</th> </tr> </thead> <tbody> <tr> <td>1-9</td> <td></td> <td>\$114.26</td> </tr> <tr> <td>10-24</td> <td></td> <td>\$108.55</td> </tr> <tr> <td>25-49</td> <td></td> <td>\$102.83</td> </tr> <tr> <td>50+</td> <td></td> <td>\$98.26</td> </tr> </tbody> </table> <p>Low PIM</p> <p>7/16 DIN Male to 7/16 DIN Male</p> <p>Max. Freq. 8 GHz</p> <p>Model No: <a href="#">PE91039</a></p>	PRICE			1-9		\$114.26	10-24		\$108.55	25-49		\$102.83	50+		\$98.26	 <table border="1"> <thead> <tr> <th colspan="3">PRICE</th> </tr> </thead> <tbody> <tr> <td>1-9</td> <td></td> <td>\$108.84</td> </tr> <tr> <td>10-24</td> <td></td> <td>\$103.40</td> </tr> <tr> <td>25-49</td> <td></td> <td>\$97.96</td> </tr> <tr> <td>50+</td> <td></td> <td>\$93.60</td> </tr> </tbody> </table> <p>Low PIM</p> <p>7/16 DIN Male to 7/16 DIN Female</p> <p>Max. Freq. 8 GHz</p> <p>Model No: <a href="#">PE91028</a></p>	PRICE			1-9		\$108.84	10-24		\$103.40	25-49		\$97.96	50+		\$93.60	 <table border="1"> <thead> <tr> <th colspan="3">PRICE</th> </tr> </thead> <tbody> <tr> <td>1-9</td> <td></td> <td>\$108.84</td> </tr> <tr> <td>10-24</td> <td></td> <td>\$103.40</td> </tr> <tr> <td>25-49</td> <td></td> <td>\$97.96</td> </tr> <tr> <td>50+</td> <td></td> <td>\$93.60</td> </tr> </tbody> </table> <p>Low PIM</p> <p>7/16 DIN Female to 7/16 DIN Female</p> <p>Max. Freq. 8 GHz</p> <p>Model No: <a href="#">PE91029</a></p>	PRICE			1-9		\$108.84	10-24		\$103.40	25-49		\$97.96	50+		\$93.60																
PRICE																																																																																
1-24		\$38.72																																																																														
25-49		\$36.78																																																																														
50-99		\$34.85																																																																														
100+	NEW	\$33.30																																																																														
PRICE																																																																																
1-9		\$114.26																																																																														
10-24		\$108.55																																																																														
25-49		\$102.83																																																																														
50+		\$98.26																																																																														
PRICE																																																																																
1-9		\$108.84																																																																														
10-24		\$103.40																																																																														
25-49		\$97.96																																																																														
50+		\$93.60																																																																														
PRICE																																																																																
1-9		\$108.84																																																																														
10-24		\$103.40																																																																														
25-49		\$97.96																																																																														
50+		\$93.60																																																																														
7	 <table border="1"> <thead> <tr> <th colspan="3">PRICE</th> </tr> </thead> <tbody> <tr> <td>1-9</td> <td></td> <td>\$142.97</td> </tr> <tr> <td>10-24</td> <td></td> <td>\$135.82</td> </tr> <tr> <td>25-49</td> <td></td> <td>\$128.67</td> </tr> <tr> <td>50+</td> <td></td> <td>\$122.95</td> </tr> </tbody> </table> <p>Low PIM</p> <p>7/16 DIN Female to 7/16 DIN Female Bulkhead</p> <p>Max. Freq. 8 GHz</p> <p>Model No: <a href="#">PE91038</a></p>	PRICE			1-9		\$142.97	10-24		\$135.82	25-49		\$128.67	50+		\$122.95	<p><b>7/16 DIN Between Series</b></p>  <table border="1"> <thead> <tr> <th colspan="3">PRICE</th> </tr> </thead> <tbody> <tr> <td>1-24</td> <td></td> <td>\$77.31</td> </tr> <tr> <td>25-49</td> <td></td> <td>\$73.44</td> </tr> <tr> <td>50-99</td> <td></td> <td>\$69.58</td> </tr> <tr> <td>100+</td> <td></td> <td>\$66.49</td> </tr> </tbody> </table> <p>Low PIM</p> <p>7/16 DIN Male to 4.1/9.5 Mini DIN Male</p> <p>VSWR 1.25:1 to 6 GHz</p> <p>Model No: <a href="#">PE91088</a></p>	PRICE			1-24		\$77.31	25-49		\$73.44	50-99		\$69.58	100+		\$66.49	 <table border="1"> <thead> <tr> <th colspan="3">PRICE</th> </tr> </thead> <tbody> <tr> <td>1-24</td> <td></td> <td>\$83.50</td> </tr> <tr> <td>25-49</td> <td></td> <td>\$79.33</td> </tr> <tr> <td>50-99</td> <td></td> <td>\$75.15</td> </tr> <tr> <td>100+</td> <td></td> <td>\$71.81</td> </tr> </tbody> </table> <p>Low PIM</p> <p>7/16 DIN Male to 4.1/9.5 Mini DIN Female</p> <p>VSWR 1.25:1 to 6 GHz</p> <p>Model No: <a href="#">PE91089</a></p>	PRICE			1-24		\$83.50	25-49		\$79.33	50-99		\$75.15	100+		\$71.81	 <table border="1"> <thead> <tr> <th colspan="3">PRICE</th> </tr> </thead> <tbody> <tr> <td>1-24</td> <td></td> <td>\$36.65</td> </tr> <tr> <td>25-49</td> <td></td> <td>\$34.82</td> </tr> <tr> <td>50-99</td> <td></td> <td>\$32.99</td> </tr> <tr> <td>100+</td> <td>NEW</td> <td>\$31.52</td> </tr> </tbody> </table> <p>Low PIM</p> <p>7/16 DIN Male to 4.3-10 Male</p> <p>VSWR 1.25:1 to 6 GHz</p> <p>Model No: <a href="#">PE91468</a></p>	PRICE			1-24		\$36.65	25-49		\$34.82	50-99		\$32.99	100+	NEW	\$31.52																
PRICE																																																																																
1-9		\$142.97																																																																														
10-24		\$135.82																																																																														
25-49		\$128.67																																																																														
50+		\$122.95																																																																														
PRICE																																																																																
1-24		\$77.31																																																																														
25-49		\$73.44																																																																														
50-99		\$69.58																																																																														
100+		\$66.49																																																																														
PRICE																																																																																
1-24		\$83.50																																																																														
25-49		\$79.33																																																																														
50-99		\$75.15																																																																														
100+		\$71.81																																																																														
PRICE																																																																																
1-24		\$36.65																																																																														
25-49		\$34.82																																																																														
50-99		\$32.99																																																																														
100+	NEW	\$31.52																																																																														

# LOW PIM ADAPTERS

See Adapter Locator on Pages 8-13

See Page 369 for Mounting Holes

	A	B	C	D	E																																																		
1	 <table border="1"> <thead> <tr> <th colspan="2">PRICE</th> </tr> </thead> <tbody> <tr> <td>1-24</td> <td>\$39.69</td> </tr> <tr> <td>25-49</td> <td>\$37.71</td> </tr> <tr> <td>50-99</td> <td>\$35.72</td> </tr> <tr> <td>100+</td> <td>\$34.13</td> </tr> </tbody> </table> <p>Low PIM NEW</p> <p>7/16 DIN Male to 4.3-10 Female</p> <p>VSWR 1.25:1 to 6 GHz</p> <p>Model No: <a href="#">PE91469</a></p>	PRICE		1-24	\$39.69	25-49	\$37.71	50-99	\$35.72	100+	\$34.13	 <table border="1"> <thead> <tr> <th colspan="2">PRICE</th> </tr> </thead> <tbody> <tr> <td>1-24</td> <td>\$69.15</td> </tr> <tr> <td>25-49</td> <td>\$65.69</td> </tr> <tr> <td>50-99</td> <td>\$62.24</td> </tr> <tr> <td>100+</td> <td>\$59.47</td> </tr> </tbody> </table> <p>Low PIM NEW</p> <p>7/16 DIN Male to 4.3-10 Female</p> <p>VSWR 1.08:1 to 6 GHz</p> <p>Model No: <a href="#">PE91390</a></p>	PRICE		1-24	\$69.15	25-49	\$65.69	50-99	\$62.24	100+	\$59.47	 <table border="1"> <thead> <tr> <th colspan="2">PRICE</th> </tr> </thead> <tbody> <tr> <td>1-24</td> <td>\$77.31</td> </tr> <tr> <td>25-49</td> <td>\$73.44</td> </tr> <tr> <td>50-99</td> <td>\$69.58</td> </tr> <tr> <td>100+</td> <td>\$66.49</td> </tr> </tbody> </table> <p>Low PIM</p> <p>7/16 DIN Female to 4.1/9.5 Mini DIN Male</p> <p>VSWR 1.25:1 to 6 GHz</p> <p>Model No: <a href="#">PE91090</a></p>	PRICE		1-24	\$77.31	25-49	\$73.44	50-99	\$69.58	100+	\$66.49	 <table border="1"> <thead> <tr> <th colspan="2">PRICE</th> </tr> </thead> <tbody> <tr> <td>1-24</td> <td>\$77.31</td> </tr> <tr> <td>25-49</td> <td>\$73.44</td> </tr> <tr> <td>50-99</td> <td>\$69.58</td> </tr> <tr> <td>100+</td> <td>\$66.49</td> </tr> </tbody> </table> <p>Low PIM</p> <p>7/16 DIN Female to 4.1/9.5 Mini DIN Female</p> <p>VSWR 1.25:1 to 6 GHz</p> <p>Model No: <a href="#">PE91091</a></p>	PRICE		1-24	\$77.31	25-49	\$73.44	50-99	\$69.58	100+	\$66.49	 <table border="1"> <thead> <tr> <th colspan="2">PRICE</th> </tr> </thead> <tbody> <tr> <td>1-24</td> <td>\$38.93</td> </tr> <tr> <td>25-49</td> <td>\$36.98</td> </tr> <tr> <td>50-99</td> <td>\$35.04</td> </tr> <tr> <td>100+</td> <td>\$33.48</td> </tr> </tbody> </table> <p>Low PIM NEW</p> <p>7/16 DIN Female to 4.3-10 Male</p> <p>VSWR 1.2:1 to 6 GHz</p> <p>Model No: <a href="#">PE91470</a></p>	PRICE		1-24	\$38.93	25-49	\$36.98	50-99	\$35.04	100+	\$33.48
	PRICE																																																						
1-24	\$39.69																																																						
25-49	\$37.71																																																						
50-99	\$35.72																																																						
100+	\$34.13																																																						
PRICE																																																							
1-24	\$69.15																																																						
25-49	\$65.69																																																						
50-99	\$62.24																																																						
100+	\$59.47																																																						
PRICE																																																							
1-24	\$77.31																																																						
25-49	\$73.44																																																						
50-99	\$69.58																																																						
100+	\$66.49																																																						
PRICE																																																							
1-24	\$77.31																																																						
25-49	\$73.44																																																						
50-99	\$69.58																																																						
100+	\$66.49																																																						
PRICE																																																							
1-24	\$38.93																																																						
25-49	\$36.98																																																						
50-99	\$35.04																																																						
100+	\$33.48																																																						
2	 <table border="1"> <thead> <tr> <th colspan="2">PRICE</th> </tr> </thead> <tbody> <tr> <td>1-24</td> <td>\$55.13</td> </tr> <tr> <td>25-49</td> <td>\$52.37</td> </tr> <tr> <td>50-99</td> <td>\$49.62</td> </tr> <tr> <td>100+</td> <td>\$47.41</td> </tr> </tbody> </table> <p>Low PIM NEW</p> <p>7/16 DIN Female to QD 4.3-10 Male</p> <p>VSWR 1.2:1 to 6 GHz</p> <p>Model No: <a href="#">PE91472</a></p>	PRICE		1-24	\$55.13	25-49	\$52.37	50-99	\$49.62	100+	\$47.41	 <table border="1"> <thead> <tr> <th colspan="2">PRICE</th> </tr> </thead> <tbody> <tr> <td>1-9</td> <td>\$112.70</td> </tr> <tr> <td>10-24</td> <td>\$107.07</td> </tr> <tr> <td>25-49</td> <td>\$101.43</td> </tr> <tr> <td>50+</td> <td>\$96.92</td> </tr> </tbody> </table> <p>Low PIM NEW</p> <p>7/16 DIN Female to 4.3-10 Male</p> <p>VSWR 1.08:1 to 6 GHz</p> <p>Model No: <a href="#">PE91391</a></p>	PRICE		1-9	\$112.70	10-24	\$107.07	25-49	\$101.43	50+	\$96.92	 <table border="1"> <thead> <tr> <th colspan="2">PRICE</th> </tr> </thead> <tbody> <tr> <td>1-24</td> <td>\$39.69</td> </tr> <tr> <td>25-49</td> <td>\$37.71</td> </tr> <tr> <td>50-99</td> <td>\$35.72</td> </tr> <tr> <td>100+</td> <td>\$34.13</td> </tr> </tbody> </table> <p>Low PIM NEW</p> <p>7/16 DIN Female to 4.3-10 Female</p> <p>VSWR 1.25:1 to 6 GHz</p> <p>Model No: <a href="#">PE91471</a></p>	PRICE		1-24	\$39.69	25-49	\$37.71	50-99	\$35.72	100+	\$34.13	 <table border="1"> <thead> <tr> <th colspan="2">PRICE</th> </tr> </thead> <tbody> <tr> <td>1-24</td> <td>\$40.53</td> </tr> <tr> <td>25-49</td> <td>\$38.50</td> </tr> <tr> <td>50-99</td> <td>\$36.48</td> </tr> <tr> <td>100+</td> <td>\$34.86</td> </tr> </tbody> </table> <p>Low PIM NEW</p> <p>7/16 DIN Female to QD 4.3-10 Female</p> <p>VSWR 1.2:1 to 6 GHz</p> <p>Model No: <a href="#">PE91473</a></p>	PRICE		1-24	\$40.53	25-49	\$38.50	50-99	\$36.48	100+	\$34.86	<p style="text-align: center;"><b>N</b></p> <p style="text-align: center;"><i>In-Series</i></p> <p style="text-align: center;">→</p>										
	PRICE																																																						
1-24	\$55.13																																																						
25-49	\$52.37																																																						
50-99	\$49.62																																																						
100+	\$47.41																																																						
PRICE																																																							
1-9	\$112.70																																																						
10-24	\$107.07																																																						
25-49	\$101.43																																																						
50+	\$96.92																																																						
PRICE																																																							
1-24	\$39.69																																																						
25-49	\$37.71																																																						
50-99	\$35.72																																																						
100+	\$34.13																																																						
PRICE																																																							
1-24	\$40.53																																																						
25-49	\$38.50																																																						
50-99	\$36.48																																																						
100+	\$34.86																																																						
3	 <table border="1"> <thead> <tr> <th colspan="2">PRICE</th> </tr> </thead> <tbody> <tr> <td>1-24</td> <td>\$94.34</td> </tr> <tr> <td>25-49</td> <td>\$89.62</td> </tr> <tr> <td>50-99</td> <td>\$84.91</td> </tr> <tr> <td>100+</td> <td>\$81.13</td> </tr> </tbody> </table> <p>Low PIM</p> <p>N Male to N Male</p> <p>Max. Freq. 12.4 GHz</p> <p>Model No: <a href="#">PE91034</a></p>	PRICE		1-24	\$94.34	25-49	\$89.62	50-99	\$84.91	100+	\$81.13	 <table border="1"> <thead> <tr> <th colspan="2">PRICE</th> </tr> </thead> <tbody> <tr> <td>1-24</td> <td>\$98.25</td> </tr> <tr> <td>25-49</td> <td>\$93.34</td> </tr> <tr> <td>50-99</td> <td>\$88.43</td> </tr> <tr> <td>100+</td> <td>\$84.50</td> </tr> </tbody> </table> <p>Low PIM</p> <p>N Male to N Female</p> <p>Max. Freq. 12.4 GHz</p> <p>Model No: <a href="#">PE91040</a></p>	PRICE		1-24	\$98.25	25-49	\$93.34	50-99	\$88.43	100+	\$84.50	 <table border="1"> <thead> <tr> <th colspan="2">PRICE</th> </tr> </thead> <tbody> <tr> <td>1-24</td> <td>\$71.22</td> </tr> <tr> <td>25-49</td> <td>\$67.66</td> </tr> <tr> <td>50-99</td> <td>\$64.10</td> </tr> <tr> <td>100+</td> <td>\$61.25</td> </tr> </tbody> </table> <p>Low PIM</p> <p>N Female to N Female</p> <p>VSWR 1.2:1 to 6 GHz</p> <p>Model No: <a href="#">PE91140</a></p>	PRICE		1-24	\$71.22	25-49	\$67.66	50-99	\$64.10	100+	\$61.25	 <table border="1"> <thead> <tr> <th colspan="2">PRICE</th> </tr> </thead> <tbody> <tr> <td>1-24</td> <td>\$63.79</td> </tr> <tr> <td>25-49</td> <td>\$60.60</td> </tr> <tr> <td>50-99</td> <td>\$57.41</td> </tr> <tr> <td>100+</td> <td>\$54.86</td> </tr> </tbody> </table> <p>Low PIM</p> <p>N Female to N Female Bulkhead</p> <p>VSWR 1.2:1 to 6 GHz</p> <p>Model No: <a href="#">PE91179</a></p>	PRICE		1-24	\$63.79	25-49	\$60.60	50-99	\$57.41	100+	\$54.86	<p style="text-align: center;"><b>N</b></p> <p style="text-align: center;"><i>Between Series</i></p> <p style="text-align: center;">→</p>										
	PRICE																																																						
1-24	\$94.34																																																						
25-49	\$89.62																																																						
50-99	\$84.91																																																						
100+	\$81.13																																																						
PRICE																																																							
1-24	\$98.25																																																						
25-49	\$93.34																																																						
50-99	\$88.43																																																						
100+	\$84.50																																																						
PRICE																																																							
1-24	\$71.22																																																						
25-49	\$67.66																																																						
50-99	\$64.10																																																						
100+	\$61.25																																																						
PRICE																																																							
1-24	\$63.79																																																						
25-49	\$60.60																																																						
50-99	\$57.41																																																						
100+	\$54.86																																																						
4	 <table border="1"> <thead> <tr> <th colspan="2">PRICE</th> </tr> </thead> <tbody> <tr> <td>1-24</td> <td>\$73.94</td> </tr> <tr> <td>25-49</td> <td>\$70.24</td> </tr> <tr> <td>50-99</td> <td>\$66.55</td> </tr> <tr> <td>100+</td> <td>\$63.59</td> </tr> </tbody> </table> <p>Low PIM NEW</p> <p>N Male to 4.3-10 Female</p> <p>VSWR 1.08:1 to 6 GHz</p> <p>Model No: <a href="#">PE91388</a></p>	PRICE		1-24	\$73.94	25-49	\$70.24	50-99	\$66.55	100+	\$63.59	 <table border="1"> <thead> <tr> <th colspan="2">PRICE</th> </tr> </thead> <tbody> <tr> <td>1-24</td> <td>\$91.69</td> </tr> <tr> <td>25-49</td> <td>\$87.11</td> </tr> <tr> <td>50-99</td> <td>\$82.52</td> </tr> <tr> <td>100+</td> <td>\$78.85</td> </tr> </tbody> </table> <p>Low PIM</p> <p>N Male to 7/16 DIN Male</p> <p>Max. Freq. 8 GHz</p> <p>Model No: <a href="#">PE91030</a></p>	PRICE		1-24	\$91.69	25-49	\$87.11	50-99	\$82.52	100+	\$78.85	 <table border="1"> <thead> <tr> <th colspan="2">PRICE</th> </tr> </thead> <tbody> <tr> <td>1-24</td> <td>\$98.25</td> </tr> <tr> <td>25-49</td> <td>\$93.34</td> </tr> <tr> <td>50-99</td> <td>\$88.43</td> </tr> <tr> <td>100+</td> <td>\$84.50</td> </tr> </tbody> </table> <p>Low PIM</p> <p>N Male to 7/16 DIN Female</p> <p>Max. Freq. 8 GHz</p> <p>Model No: <a href="#">PE91032</a></p>	PRICE		1-24	\$98.25	25-49	\$93.34	50-99	\$88.43	100+	\$84.50	 <table border="1"> <thead> <tr> <th colspan="2">PRICE</th> </tr> </thead> <tbody> <tr> <td>1-24</td> <td>\$51.36</td> </tr> <tr> <td>25-49</td> <td>\$48.79</td> </tr> <tr> <td>50-99</td> <td>\$46.22</td> </tr> <tr> <td>100+</td> <td>\$44.17</td> </tr> </tbody> </table> <p>Low PIM</p> <p>N Male to SMA Female</p> <p>VSWR 1.2:1 to 6 GHz</p> <p>Model No: <a href="#">PE91177</a></p>	PRICE		1-24	\$51.36	25-49	\$48.79	50-99	\$46.22	100+	\$44.17	 <table border="1"> <thead> <tr> <th colspan="2">PRICE</th> </tr> </thead> <tbody> <tr> <td>1-24</td> <td>\$96.37</td> </tr> <tr> <td>25-49</td> <td>\$91.55</td> </tr> <tr> <td>50-99</td> <td>\$86.73</td> </tr> <tr> <td>100+</td> <td>\$82.88</td> </tr> </tbody> </table> <p>Low PIM</p> <p>N Female to 7/16 DIN Male</p> <p>Max. Freq. 8 GHz</p> <p>Model No: <a href="#">PE91031</a></p>	PRICE		1-24	\$96.37	25-49	\$91.55	50-99	\$86.73	100+	\$82.88
	PRICE																																																						
1-24	\$73.94																																																						
25-49	\$70.24																																																						
50-99	\$66.55																																																						
100+	\$63.59																																																						
PRICE																																																							
1-24	\$91.69																																																						
25-49	\$87.11																																																						
50-99	\$82.52																																																						
100+	\$78.85																																																						
PRICE																																																							
1-24	\$98.25																																																						
25-49	\$93.34																																																						
50-99	\$88.43																																																						
100+	\$84.50																																																						
PRICE																																																							
1-24	\$51.36																																																						
25-49	\$48.79																																																						
50-99	\$46.22																																																						
100+	\$44.17																																																						
PRICE																																																							
1-24	\$96.37																																																						
25-49	\$91.55																																																						
50-99	\$86.73																																																						
100+	\$82.88																																																						
5	 <table border="1"> <thead> <tr> <th colspan="2">PRICE</th> </tr> </thead> <tbody> <tr> <td>1-24</td> <td>\$98.25</td> </tr> <tr> <td>25-49</td> <td>\$93.34</td> </tr> <tr> <td>50-99</td> <td>\$88.43</td> </tr> <tr> <td>100+</td> <td>\$84.50</td> </tr> </tbody> </table> <p>Low PIM</p> <p>N Female to 7/16 DIN Female</p> <p>Max. Freq. 8 GHz</p> <p>Model No: <a href="#">PE91033</a></p>	PRICE		1-24	\$98.25	25-49	\$93.34	50-99	\$88.43	100+	\$84.50	 <table border="1"> <thead> <tr> <th colspan="2">PRICE</th> </tr> </thead> <tbody> <tr> <td>1-9</td> <td>\$141.81</td> </tr> <tr> <td>10-24</td> <td>\$134.72</td> </tr> <tr> <td>25-49</td> <td>\$127.63</td> </tr> <tr> <td>50+</td> <td>\$121.96</td> </tr> </tbody> </table> <p>Low PIM</p> <p>N Female to 7/16 DIN Female</p> <p>Max. Freq. 8 GHz</p> <p>Model No: <a href="#">PE9180</a></p>	PRICE		1-9	\$141.81	10-24	\$134.72	25-49	\$127.63	50+	\$121.96	 <table border="1"> <thead> <tr> <th colspan="2">PRICE</th> </tr> </thead> <tbody> <tr> <td>1-24</td> <td>\$52.30</td> </tr> <tr> <td>25-49</td> <td>\$49.69</td> </tr> <tr> <td>50-99</td> <td>\$47.07</td> </tr> <tr> <td>100+</td> <td>\$44.98</td> </tr> </tbody> </table> <p>Low PIM</p> <p>N Female to SMA Male</p> <p>VSWR 1.2:1 to 6 GHz</p> <p>Model No: <a href="#">PE91178</a></p>	PRICE		1-24	\$52.30	25-49	\$49.69	50-99	\$47.07	100+	\$44.98	<p style="text-align: center;"><b>SMA</b></p> <p style="text-align: center;"><i>Between Series</i></p> <p style="text-align: center;">→</p>	 <table border="1"> <thead> <tr> <th colspan="2">PRICE</th> </tr> </thead> <tbody> <tr> <td>1-9</td> <td>\$119.52</td> </tr> <tr> <td>10-24</td> <td>\$113.54</td> </tr> <tr> <td>25-49</td> <td>\$107.57</td> </tr> <tr> <td>50+</td> <td>\$102.79</td> </tr> </tbody> </table> <p>Low PIM</p> <p>SMA Male to 7/16 DIN Male</p> <p>VSWR 1.09:1 to 7.5 GHz</p> <p>Model No: <a href="#">PE91043</a></p>	PRICE		1-9	\$119.52	10-24	\$113.54	25-49	\$107.57	50+	\$102.79										
	PRICE																																																						
1-24	\$98.25																																																						
25-49	\$93.34																																																						
50-99	\$88.43																																																						
100+	\$84.50																																																						
PRICE																																																							
1-9	\$141.81																																																						
10-24	\$134.72																																																						
25-49	\$127.63																																																						
50+	\$121.96																																																						
PRICE																																																							
1-24	\$52.30																																																						
25-49	\$49.69																																																						
50-99	\$47.07																																																						
100+	\$44.98																																																						
PRICE																																																							
1-9	\$119.52																																																						
10-24	\$113.54																																																						
25-49	\$107.57																																																						
50+	\$102.79																																																						
6	 <table border="1"> <thead> <tr> <th colspan="2">PRICE</th> </tr> </thead> <tbody> <tr> <td>1-9</td> <td>\$107.89</td> </tr> <tr> <td>10-24</td> <td>\$102.50</td> </tr> <tr> <td>25-49</td> <td>\$97.10</td> </tr> <tr> <td>50+</td> <td>\$92.79</td> </tr> </tbody> </table> <p>Low PIM</p> <p>SMA Male to 7/16 DIN Female</p> <p>Max. Freq. 8 GHz</p> <p>Model No: <a href="#">PE91041</a></p>	PRICE		1-9	\$107.89	10-24	\$102.50	25-49	\$97.10	50+	\$92.79	 <table border="1"> <thead> <tr> <th colspan="2">PRICE</th> </tr> </thead> <tbody> <tr> <td>1-24</td> <td>\$90.94</td> </tr> <tr> <td>25-49</td> <td>\$86.39</td> </tr> <tr> <td>50-99</td> <td>\$81.85</td> </tr> <tr> <td>100+</td> <td>\$78.21</td> </tr> </tbody> </table> <p>Low PIM</p> <p>SMA Female to 7/16 DIN Male</p> <p>VSWR 1.09:1 to 7.5 GHz</p> <p>Model No: <a href="#">PE91036</a></p>	PRICE		1-24	\$90.94	25-49	\$86.39	50-99	\$81.85	100+	\$78.21	 <table border="1"> <thead> <tr> <th colspan="2">PRICE</th> </tr> </thead> <tbody> <tr> <td>1-24</td> <td>\$91.69</td> </tr> <tr> <td>25-49</td> <td>\$87.11</td> </tr> <tr> <td>50-99</td> <td>\$82.52</td> </tr> <tr> <td>100+</td> <td>\$78.85</td> </tr> </tbody> </table> <p>Low PIM</p> <p>SMA Female to 7/16 DIN Female</p> <p>Max. Freq. 8 GHz</p> <p>Model No: <a href="#">PE91042</a></p>	PRICE		1-24	\$91.69	25-49	\$87.11	50-99	\$82.52	100+	\$78.85	<p style="text-align: center;"><b>TNC</b></p> <p style="text-align: center;"><i>In-Series</i></p> <p style="text-align: center;">→</p>	 <table border="1"> <thead> <tr> <th colspan="2">PRICE</th> </tr> </thead> <tbody> <tr> <td>1-24</td> <td>\$61.44</td> </tr> <tr> <td>25-49</td> <td>\$58.37</td> </tr> <tr> <td>50-99</td> <td>\$55.30</td> </tr> <tr> <td>100+</td> <td>\$52.84</td> </tr> </tbody> </table> <p>Low PIM</p> <p>TNC Male to TNC Male</p> <p>VSWR 1.25:1 to 6 GHz</p> <p>Model No: <a href="#">PE91172</a></p>	PRICE		1-24	\$61.44	25-49	\$58.37	50-99	\$55.30	100+	\$52.84										
	PRICE																																																						
1-9	\$107.89																																																						
10-24	\$102.50																																																						
25-49	\$97.10																																																						
50+	\$92.79																																																						
PRICE																																																							
1-24	\$90.94																																																						
25-49	\$86.39																																																						
50-99	\$81.85																																																						
100+	\$78.21																																																						
PRICE																																																							
1-24	\$91.69																																																						
25-49	\$87.11																																																						
50-99	\$82.52																																																						
100+	\$78.85																																																						
PRICE																																																							
1-24	\$61.44																																																						
25-49	\$58.37																																																						
50-99	\$55.30																																																						
100+	\$52.84																																																						
7	 <table border="1"> <thead> <tr> <th colspan="2">PRICE</th> </tr> </thead> <tbody> <tr> <td>1-24</td> <td>\$58.54</td> </tr> <tr> <td>25-49</td> <td>\$55.61</td> </tr> <tr> <td>50-99</td> <td>\$52.69</td> </tr> <tr> <td>100+</td> <td>\$50.34</td> </tr> </tbody> </table> <p>Low PIM</p> <p>TNC Male to TNC Female</p> <p>VSWR 1.25:1 to 6 GHz</p> <p>Model No: <a href="#">PE91173</a></p>	PRICE		1-24	\$58.54	25-49	\$55.61	50-99	\$52.69	100+	\$50.34	 <table border="1"> <thead> <tr> <th colspan="2">PRICE</th> </tr> </thead> <tbody> <tr> <td>1-24</td> <td>\$53.66</td> </tr> <tr> <td>25-49</td> <td>\$50.98</td> </tr> <tr> <td>50-99</td> <td>\$48.29</td> </tr> <tr> <td>100+</td> <td>\$46.15</td> </tr> </tbody> </table> <p>Low PIM</p> <p>TNC Female to TNC Female</p> <p>VSWR 1.25:1 to 6 GHz</p> <p>Model No: <a href="#">PE91174</a></p>	PRICE		1-24	\$53.66	25-49	\$50.98	50-99	\$48.29	100+	\$46.15																																	
	PRICE																																																						
1-24	\$58.54																																																						
25-49	\$55.61																																																						
50-99	\$52.69																																																						
100+	\$50.34																																																						
PRICE																																																							
1-24	\$53.66																																																						
25-49	\$50.98																																																						
50-99	\$48.29																																																						
100+	\$46.15																																																						

See Our Website For Current Pricing & Real-Time Stock Availability!



Technical Support  
+1 (949) 261-1920



Same-Day Shipping,  
Even Custom Cable Assemblies

# ADAPTERS

See Adapter Locator on Pages 8-13

See Page 369 for Mounting Holes

Adapters

See Our Website For Current Pricing & Real-Time Stock Availability!

	A	B	C	D	E																																								
1	<p><b>1.0mm In-Series</b></p>  <p>Model No: <a href="#">PE91462</a></p>	<p><b>PRICE</b></p> <table border="1"> <tr><td>1-24</td><td>\$1,697.14</td></tr> <tr><td>25-49</td><td>\$1,578.34</td></tr> <tr><td>50-99</td><td>\$1,459.54</td></tr> <tr><td>NEW 100+</td><td>\$1,357.71</td></tr> </table> <p>1.0mm Male to 1.0mm Male VSWR 1.28:1 to 110 GHz</p> <p>Model No: <a href="#">PE91462</a></p>	1-24	\$1,697.14	25-49	\$1,578.34	50-99	\$1,459.54	NEW 100+	\$1,357.71	<p><b>PRICE</b></p> <table border="1"> <tr><td>1-1</td><td>\$1,763.33</td></tr> <tr><td>2-4</td><td>\$1,692.80</td></tr> <tr><td>5-9</td><td>\$1,622.26</td></tr> <tr><td>NEW 10+</td><td>\$1,551.73</td></tr> </table> <p>1.0mm Female to 1.0mm Male VSWR 1.28:1 to 110 GHz</p> <p>Model No: <a href="#">PE91461</a></p>	1-1	\$1,763.33	2-4	\$1,692.80	5-9	\$1,622.26	NEW 10+	\$1,551.73	<p><b>PRICE</b></p> <table border="1"> <tr><td>1-1</td><td>\$1,763.33</td></tr> <tr><td>2-4</td><td>\$1,692.80</td></tr> <tr><td>5-9</td><td>\$1,622.26</td></tr> <tr><td>NEW 10+</td><td>\$1,551.73</td></tr> </table> <p>1.0mm Female to 1.0mm Female VSWR 1.28:1 to 110 GHz</p> <p>Model No: <a href="#">PE91463</a></p>	1-1	\$1,763.33	2-4	\$1,692.80	5-9	\$1,622.26	NEW 10+	\$1,551.73	<p><b>1.0mm Between Series</b></p> 																
1-24	\$1,697.14																																												
25-49	\$1,578.34																																												
50-99	\$1,459.54																																												
NEW 100+	\$1,357.71																																												
1-1	\$1,763.33																																												
2-4	\$1,692.80																																												
5-9	\$1,622.26																																												
NEW 10+	\$1,551.73																																												
1-1	\$1,763.33																																												
2-4	\$1,692.80																																												
5-9	\$1,622.26																																												
NEW 10+	\$1,551.73																																												
2	<p><b>PRICE</b></p> <table border="1"> <tr><td>1-4</td><td>\$727.91</td></tr> <tr><td>5-9</td><td>\$691.51</td></tr> <tr><td>10-24</td><td>\$655.12</td></tr> <tr><td>25+</td><td>\$626.00</td></tr> </table> <p>1.0mm Male to 1.85mm Male VSWR 1.25:1 to 65 GHz</p> <p>Model No: <a href="#">PE91118</a></p>	1-4	\$727.91	5-9	\$691.51	10-24	\$655.12	25+	\$626.00	<p><b>PRICE</b></p> <table border="1"> <tr><td>1-4</td><td>\$620.90</td></tr> <tr><td>5-9</td><td>\$589.86</td></tr> <tr><td>10-24</td><td>\$558.81</td></tr> <tr><td>25+</td><td>\$533.97</td></tr> </table> <p>1.0mm Male to 1.85mm Female VSWR 1.35:1 to 65 GHz</p> <p>Model No: <a href="#">PE91108</a></p>	1-4	\$620.90	5-9	\$589.86	10-24	\$558.81	25+	\$533.97	<p><b>PRICE</b></p> <table border="1"> <tr><td>1-4</td><td>\$588.96</td></tr> <tr><td>5-9</td><td>\$559.51</td></tr> <tr><td>10-24</td><td>\$530.06</td></tr> <tr><td>25+</td><td>\$506.51</td></tr> </table> <p>1.0mm Female to 1.85mm Male VSWR 1.25:1 to 65 GHz</p> <p>Model No: <a href="#">PE91119</a></p>	1-4	\$588.96	5-9	\$559.51	10-24	\$530.06	25+	\$506.51	<p><b>PRICE</b></p> <table border="1"> <tr><td>1-4</td><td>\$620.90</td></tr> <tr><td>5-9</td><td>\$589.86</td></tr> <tr><td>10-24</td><td>\$558.81</td></tr> <tr><td>25+</td><td>\$533.97</td></tr> </table> <p>1.0mm Female to 1.85mm Female VSWR 1.35:1 to 65 GHz</p> <p>Model No: <a href="#">PE91109</a></p>	1-4	\$620.90	5-9	\$589.86	10-24	\$558.81	25+	\$533.97	<p><b>1.85mm In-Series</b></p> 								
1-4	\$727.91																																												
5-9	\$691.51																																												
10-24	\$655.12																																												
25+	\$626.00																																												
1-4	\$620.90																																												
5-9	\$589.86																																												
10-24	\$558.81																																												
25+	\$533.97																																												
1-4	\$588.96																																												
5-9	\$559.51																																												
10-24	\$530.06																																												
25+	\$506.51																																												
1-4	\$620.90																																												
5-9	\$589.86																																												
10-24	\$558.81																																												
25+	\$533.97																																												
3	<p><b>PRICE</b></p> <table border="1"> <tr><td>1-4</td><td>\$784.38</td></tr> <tr><td>5-9</td><td>\$745.16</td></tr> <tr><td>10-24</td><td>\$705.94</td></tr> <tr><td>25+</td><td>\$674.57</td></tr> </table> <p>1.85mm Male to 1.85mm Male VSWR 1.35:1 to 67 GHz</p> <p>Model No: <a href="#">PE91085</a></p>	1-4	\$784.38	5-9	\$745.16	10-24	\$705.94	25+	\$674.57	<p><b>PRICE</b></p> <table border="1"> <tr><td>1-4</td><td>\$705.79</td></tr> <tr><td>5-9</td><td>\$670.50</td></tr> <tr><td>10-24</td><td>\$635.21</td></tr> <tr><td>25+</td><td>\$606.98</td></tr> </table> <p>1.85mm Male to 1.85mm Male VSWR 1.5:1 to 65 GHz</p> <p>Model No: <a href="#">PE9716</a></p>	1-4	\$705.79	5-9	\$670.50	10-24	\$635.21	25+	\$606.98	<p><b>PRICE</b></p> <table border="1"> <tr><td>1-4</td><td>\$719.61</td></tr> <tr><td>5-9</td><td>\$683.63</td></tr> <tr><td>10-24</td><td>\$647.65</td></tr> <tr><td>25+</td><td>\$618.86</td></tr> </table> <p>1.85mm Male to 1.85mm Female VSWR 1.35:1 to 67 GHz</p> <p>Model No: <a href="#">PE91086</a></p>	1-4	\$719.61	5-9	\$683.63	10-24	\$647.65	25+	\$618.86	<p><b>PRICE</b></p> <table border="1"> <tr><td>1-4</td><td>\$705.79</td></tr> <tr><td>5-9</td><td>\$670.50</td></tr> <tr><td>10-24</td><td>\$635.21</td></tr> <tr><td>25+</td><td>\$606.98</td></tr> </table> <p>1.85mm Male to 1.85mm Female VSWR 1.5:1 to 65 GHz</p> <p>Model No: <a href="#">PE9715</a></p>	1-4	\$705.79	5-9	\$670.50	10-24	\$635.21	25+	\$606.98	<p><b>PRICE</b></p> <table border="1"> <tr><td>1-4</td><td>\$719.61</td></tr> <tr><td>5-9</td><td>\$683.63</td></tr> <tr><td>10-24</td><td>\$647.65</td></tr> <tr><td>25+</td><td>\$618.86</td></tr> </table> <p>1.85mm Female to 1.85mm Female Max. Freq. 67 GHz</p> <p>Model No: <a href="#">PE91084</a></p>	1-4	\$719.61	5-9	\$683.63	10-24	\$647.65	25+	\$618.86
1-4	\$784.38																																												
5-9	\$745.16																																												
10-24	\$705.94																																												
25+	\$674.57																																												
1-4	\$705.79																																												
5-9	\$670.50																																												
10-24	\$635.21																																												
25+	\$606.98																																												
1-4	\$719.61																																												
5-9	\$683.63																																												
10-24	\$647.65																																												
25+	\$618.86																																												
1-4	\$705.79																																												
5-9	\$670.50																																												
10-24	\$635.21																																												
25+	\$606.98																																												
1-4	\$719.61																																												
5-9	\$683.63																																												
10-24	\$647.65																																												
25+	\$618.86																																												
4	<p><b>PRICE</b></p> <table border="1"> <tr><td>1-4</td><td>\$595.19</td></tr> <tr><td>5-9</td><td>\$565.43</td></tr> <tr><td>10-24</td><td>\$535.67</td></tr> <tr><td>25+</td><td>\$511.86</td></tr> </table> <p>1.85mm Female to 1.85mm Female VSWR 1.25:1 to 67 GHz</p> <p>Model No: <a href="#">PE91115</a></p>	1-4	\$595.19	5-9	\$565.43	10-24	\$535.67	25+	\$511.86	<p><b>1.85mm Between Series</b></p> 	<p><b>PRICE</b></p> <table border="1"> <tr><td>1-24</td><td>\$371.10</td></tr> <tr><td>25-49</td><td>\$345.12</td></tr> <tr><td>50-99</td><td>\$319.15</td></tr> <tr><td>100+</td><td>\$296.88</td></tr> </table> <p>1.85mm Male to 2.92mm Male Right Angle VSWR 1.3:1 to 40 GHz</p> <p>Model No: <a href="#">PE91161</a></p>	1-24	\$371.10	25-49	\$345.12	50-99	\$319.15	100+	\$296.88	<p><b>PRICE</b></p> <table border="1"> <tr><td>1-9</td><td>\$217.17</td></tr> <tr><td>10-24</td><td>\$206.31</td></tr> <tr><td>25-49</td><td>\$195.45</td></tr> <tr><td>50+</td><td>\$186.77</td></tr> </table> <p>1.85mm Male to 3.5mm Female VSWR 1.3:1 to 34 GHz</p> <p>Model No: <a href="#">PE9747</a></p>	1-9	\$217.17	10-24	\$206.31	25-49	\$195.45	50+	\$186.77	<p><b>PRICE</b></p> <table border="1"> <tr><td>1-9</td><td>\$215.82</td></tr> <tr><td>10-24</td><td>\$205.03</td></tr> <tr><td>25-49</td><td>\$194.24</td></tr> <tr><td>50+</td><td>\$185.61</td></tr> </table> <p>1.85mm Male to N Male VSWR 1.25:1 to 18 GHz</p> <p>Model No: <a href="#">PE9718</a></p>	1-9	\$215.82	10-24	\$205.03	25-49	\$194.24	50+	\$185.61								
1-4	\$595.19																																												
5-9	\$565.43																																												
10-24	\$535.67																																												
25+	\$511.86																																												
1-24	\$371.10																																												
25-49	\$345.12																																												
50-99	\$319.15																																												
100+	\$296.88																																												
1-9	\$217.17																																												
10-24	\$206.31																																												
25-49	\$195.45																																												
50+	\$186.77																																												
1-9	\$215.82																																												
10-24	\$205.03																																												
25-49	\$194.24																																												
50+	\$185.61																																												
5	<p><b>PRICE</b></p> <table border="1"> <tr><td>1-9</td><td>\$219.75</td></tr> <tr><td>10-24</td><td>\$208.76</td></tr> <tr><td>25-49</td><td>\$197.78</td></tr> <tr><td>50+</td><td>\$188.99</td></tr> </table> <p>1.85mm Male to N Female VSWR 1.25:1 to 18 GHz</p> <p>Model No: <a href="#">PE9719</a></p>	1-9	\$219.75	10-24	\$208.76	25-49	\$197.78	50+	\$188.99	<p><b>PRICE</b></p> <table border="1"> <tr><td>1-9</td><td>\$392.03</td></tr> <tr><td>10-24</td><td>\$372.43</td></tr> <tr><td>25-49</td><td>\$352.83</td></tr> <tr><td>50+</td><td>\$337.15</td></tr> </table> <p>1.85mm Female to 2.4mm Female Right Angle VSWR 1.4:1 to 50 GHz</p> <p>Model No: <a href="#">PE91159</a></p>	1-9	\$392.03	10-24	\$372.43	25-49	\$352.83	50+	\$337.15	<p><b>PRICE</b></p> <table border="1"> <tr><td>1-24</td><td>\$371.09</td></tr> <tr><td>25-49</td><td>\$345.11</td></tr> <tr><td>50-99</td><td>\$319.14</td></tr> <tr><td>100+</td><td>\$296.87</td></tr> </table> <p>1.85mm Female to 2.92mm Male Right Angle VSWR 1.3:1 to 40 GHz</p> <p>Model No: <a href="#">PE91162</a></p>	1-24	\$371.09	25-49	\$345.11	50-99	\$319.14	100+	\$296.87	<p><b>PRICE</b></p> <table border="1"> <tr><td>1-9</td><td>\$233.16</td></tr> <tr><td>10-24</td><td>\$221.50</td></tr> <tr><td>25-49</td><td>\$209.84</td></tr> <tr><td>50+</td><td>\$200.52</td></tr> </table> <p>1.85mm Female to N Male VSWR 1.25:1 to 18 GHz</p> <p>Model No: <a href="#">PE9720</a></p>	1-9	\$233.16	10-24	\$221.50	25-49	\$209.84	50+	\$200.52	<p><b>PRICE</b></p> <table border="1"> <tr><td>1-9</td><td>\$219.75</td></tr> <tr><td>10-24</td><td>\$208.76</td></tr> <tr><td>25-49</td><td>\$197.78</td></tr> <tr><td>50+</td><td>\$188.99</td></tr> </table> <p>1.85mm Female to N Female VSWR 1.25:1 to 18 GHz</p> <p>Model No: <a href="#">PE9721</a></p>	1-9	\$219.75	10-24	\$208.76	25-49	\$197.78	50+	\$188.99
1-9	\$219.75																																												
10-24	\$208.76																																												
25-49	\$197.78																																												
50+	\$188.99																																												
1-9	\$392.03																																												
10-24	\$372.43																																												
25-49	\$352.83																																												
50+	\$337.15																																												
1-24	\$371.09																																												
25-49	\$345.11																																												
50-99	\$319.14																																												
100+	\$296.87																																												
1-9	\$233.16																																												
10-24	\$221.50																																												
25-49	\$209.84																																												
50+	\$200.52																																												
1-9	\$219.75																																												
10-24	\$208.76																																												
25-49	\$197.78																																												
50+	\$188.99																																												
6	<p><b>2.4mm In-Series</b></p> 	<p><b>PRICE</b></p> <table border="1"> <tr><td>1-9</td><td>\$211.17</td></tr> <tr><td>10-24</td><td>\$200.61</td></tr> <tr><td>25-49</td><td>\$190.05</td></tr> <tr><td>50+</td><td>\$181.61</td></tr> </table> <p>2.4mm Male to 2.4mm Male VSWR 1.3:1 to 50 GHz</p> <p>Model No: <a href="#">PE9451</a></p>	1-9	\$211.17	10-24	\$200.61	25-49	\$190.05	50+	\$181.61	<p><b>PRICE</b></p> <table border="1"> <tr><td>1-9</td><td>\$215.28</td></tr> <tr><td>10-24</td><td>\$204.52</td></tr> <tr><td>25-49</td><td>\$193.75</td></tr> <tr><td>50+</td><td>\$185.14</td></tr> </table> <p>2.4mm Male to 2.4mm Female VSWR 1.3:1 to 50 GHz</p> <p>Model No: <a href="#">PE9452</a></p>	1-9	\$215.28	10-24	\$204.52	25-49	\$193.75	50+	\$185.14	<p><b>PRICE</b></p> <table border="1"> <tr><td>1-9</td><td>\$211.17</td></tr> <tr><td>10-24</td><td>\$200.61</td></tr> <tr><td>25-49</td><td>\$190.05</td></tr> <tr><td>50+</td><td>\$181.61</td></tr> </table> <p>2.4mm Female to 2.4mm Female VSWR 1.3:1 to 50 GHz</p> <p>Model No: <a href="#">PE9453</a></p>	1-9	\$211.17	10-24	\$200.61	25-49	\$190.05	50+	\$181.61	<p><b>PRICE</b></p> <table border="1"> <tr><td>1-24</td><td>\$191.93</td></tr> <tr><td>25-49</td><td>\$182.33</td></tr> <tr><td>50-99</td><td>\$172.74</td></tr> <tr><td>NEW 100+</td><td>\$165.06</td></tr> </table> <p>2.4mm Female to 2.4mm Female Bulkhead VSWR 1.3:1 to 50 GHz</p> <p>Model No: <a href="#">PE91459</a></p>	1-24	\$191.93	25-49	\$182.33	50-99	\$172.74	NEW 100+	\$165.06								
1-9	\$211.17																																												
10-24	\$200.61																																												
25-49	\$190.05																																												
50+	\$181.61																																												
1-9	\$215.28																																												
10-24	\$204.52																																												
25-49	\$193.75																																												
50+	\$185.14																																												
1-9	\$211.17																																												
10-24	\$200.61																																												
25-49	\$190.05																																												
50+	\$181.61																																												
1-24	\$191.93																																												
25-49	\$182.33																																												
50-99	\$172.74																																												
NEW 100+	\$165.06																																												
7	<p><b>PRICE</b></p> <table border="1"> <tr><td>1-9</td><td>\$413.19</td></tr> <tr><td>10-24</td><td>\$392.53</td></tr> <tr><td>25-49</td><td>\$371.87</td></tr> <tr><td>50+</td><td>\$355.34</td></tr> </table> <p>2.4mm Female to 2.4mm Female Bulkhead VSWR 1.35:1 to 50 GHz</p> <p>Model No: <a href="#">PE9640</a></p>	1-9	\$413.19	10-24	\$392.53	25-49	\$371.87	50+	\$355.34	<p><b>2.4mm Between Series</b></p> 	<p><b>PRICE</b></p> <table border="1"> <tr><td>1-4</td><td>\$602.78</td></tr> <tr><td>5-9</td><td>\$572.64</td></tr> <tr><td>10-24</td><td>\$542.50</td></tr> <tr><td>25+</td><td>\$518.39</td></tr> </table> <p>2.4mm Male to 1.85mm Male VSWR 1.3:1 to 50 GHz</p> <p>Model No: <a href="#">PE9672</a></p>	1-4	\$602.78	5-9	\$572.64	10-24	\$542.50	25+	\$518.39	<p><b>PRICE</b></p> <table border="1"> <tr><td>1-9</td><td>\$383.29</td></tr> <tr><td>10-24</td><td>\$364.13</td></tr> <tr><td>25-49</td><td>\$344.96</td></tr> <tr><td>50+</td><td>\$329.63</td></tr> </table> <p>2.4mm Male to 1.85mm Female VSWR 1.3:1 to 50 GHz</p> <p>Model No: <a href="#">PE9674</a></p>	1-9	\$383.29	10-24	\$364.13	25-49	\$344.96	50+	\$329.63	<p><b>PRICE</b></p> <table border="1"> <tr><td>1-24</td><td>\$393.60</td></tr> <tr><td>25-49</td><td>\$366.05</td></tr> <tr><td>50-99</td><td>\$338.50</td></tr> <tr><td>100+</td><td>\$314.88</td></tr> </table> <p>2.4mm Male to 2.92mm Male Miter Right Angle VSWR 1.25:1 to 40 GHz</p> <p>Model No: <a href="#">PE91508</a></p>	1-24	\$393.60	25-49	\$366.05	50-99	\$338.50	100+	\$314.88								
1-9	\$413.19																																												
10-24	\$392.53																																												
25-49	\$371.87																																												
50+	\$355.34																																												
1-4	\$602.78																																												
5-9	\$572.64																																												
10-24	\$542.50																																												
25+	\$518.39																																												
1-9	\$383.29																																												
10-24	\$364.13																																												
25-49	\$344.96																																												
50+	\$329.63																																												
1-24	\$393.60																																												
25-49	\$366.05																																												
50-99	\$338.50																																												
100+	\$314.88																																												

# ADAPTERS

See Adapter Locator on Pages 8-13

See Page 369 for Mounting Holes

Adapters

See Our Website For Current Pricing & Real-Time Stock Availability!

	A	B	C	D	E																																													
1	 <table border="1"> <thead> <tr><th>PRICE</th></tr> </thead> <tbody> <tr><td>1-24</td><td>\$337.70</td></tr> <tr><td>25-49</td><td>\$314.06</td></tr> <tr><td>50-99</td><td>\$290.42</td></tr> <tr><td>100+</td><td>\$270.16</td></tr> </tbody> </table> <p>2.4mm Male to 2.92mm Female Miter Right Angle VSWR 1.25:1 to 40 GHz</p> <p>Model No: <a href="#">PE91502</a></p>	PRICE	1-24	\$337.70	25-49	\$314.06	50-99	\$290.42	100+	\$270.16	 <table border="1"> <thead> <tr><th>PRICE</th></tr> </thead> <tbody> <tr><td>1-4</td><td>\$703.42</td></tr> <tr><td>5-9</td><td>\$668.25</td></tr> <tr><td>10-24</td><td>\$633.08</td></tr> <tr><td>25+</td><td>\$604.94</td></tr> </tbody> </table> <p>2.4mm Male to 7mm Sexless VSWR 1.1:1 to 18 GHz</p> <p>Model No: <a href="#">PE9458</a></p>	PRICE	1-4	\$703.42	5-9	\$668.25	10-24	\$633.08	25+	\$604.94	 <table border="1"> <thead> <tr><th>PRICE</th></tr> </thead> <tbody> <tr><td>1-9</td><td>\$285.27</td></tr> <tr><td>10-24</td><td>\$271.01</td></tr> <tr><td>25-49</td><td>\$256.74</td></tr> <tr><td>50+</td><td>\$245.33</td></tr> </tbody> </table> <p>2.4mm Male to Full Detent Mini SMP Male VSWR 1.25:1 to 50 GHz</p> <p>Model No: <a href="#">PE91121</a></p>	PRICE	1-9	\$285.27	10-24	\$271.01	25-49	\$256.74	50+	\$245.33	 <table border="1"> <thead> <tr><th>PRICE</th></tr> </thead> <tbody> <tr><td>1-9</td><td>\$293.12</td></tr> <tr><td>10-24</td><td>\$278.46</td></tr> <tr><td>25-49</td><td>\$263.81</td></tr> <tr><td>50+</td><td>\$252.08</td></tr> </tbody> </table> <p>2.4mm Male to Mini SMP Female VSWR 1.25:1 to 50 GHz</p> <p>Model No: <a href="#">PE91120</a></p>	PRICE	1-9	\$293.12	10-24	\$278.46	25-49	\$263.81	50+	\$252.08	 <table border="1"> <thead> <tr><th>PRICE</th></tr> </thead> <tbody> <tr><td>1-9</td><td>\$223.14</td></tr> <tr><td>10-24</td><td>\$211.98</td></tr> <tr><td>25-49</td><td>\$200.83</td></tr> <tr><td>50+</td><td>\$191.90</td></tr> </tbody> </table> <p>PRECISION 2.4mm Male to N Male VSWR 1.15:1 to 18 GHz</p> <p>Model No: <a href="#">PE9504</a></p>	PRICE	1-9	\$223.14	10-24	\$211.98	25-49	\$200.83	50+	\$191.90
PRICE																																																		
1-24	\$337.70																																																	
25-49	\$314.06																																																	
50-99	\$290.42																																																	
100+	\$270.16																																																	
PRICE																																																		
1-4	\$703.42																																																	
5-9	\$668.25																																																	
10-24	\$633.08																																																	
25+	\$604.94																																																	
PRICE																																																		
1-9	\$285.27																																																	
10-24	\$271.01																																																	
25-49	\$256.74																																																	
50+	\$245.33																																																	
PRICE																																																		
1-9	\$293.12																																																	
10-24	\$278.46																																																	
25-49	\$263.81																																																	
50+	\$252.08																																																	
PRICE																																																		
1-9	\$223.14																																																	
10-24	\$211.98																																																	
25-49	\$200.83																																																	
50+	\$191.90																																																	
2	 <table border="1"> <thead> <tr><th>PRICE</th></tr> </thead> <tbody> <tr><td>1-9</td><td>\$239.04</td></tr> <tr><td>10-24</td><td>\$227.09</td></tr> <tr><td>25-49</td><td>\$215.14</td></tr> <tr><td>50+</td><td>\$205.57</td></tr> </tbody> </table> <p>PRECISION 2.4mm Male to N Female VSWR 1.15:1 to 18 GHz</p> <p>Model No: <a href="#">PE9501</a></p>	PRICE	1-9	\$239.04	10-24	\$227.09	25-49	\$215.14	50+	\$205.57	 <table border="1"> <thead> <tr><th>PRICE</th></tr> </thead> <tbody> <tr><td>1-4</td><td>\$569.84</td></tr> <tr><td>5-9</td><td>\$541.35</td></tr> <tr><td>10-24</td><td>\$512.86</td></tr> <tr><td>25+</td><td>\$490.06</td></tr> </tbody> </table> <p>2.4mm Female to 1.85mm Male VSWR 1.3:1 to 50 GHz</p> <p>Model No: <a href="#">PE9673</a></p>	PRICE	1-4	\$569.84	5-9	\$541.35	10-24	\$512.86	25+	\$490.06	 <table border="1"> <thead> <tr><th>PRICE</th></tr> </thead> <tbody> <tr><td>1-4</td><td>\$566.37</td></tr> <tr><td>5-9</td><td>\$538.05</td></tr> <tr><td>10-24</td><td>\$509.73</td></tr> <tr><td>25+</td><td>\$487.08</td></tr> </tbody> </table> <p>2.4mm Female to 1.85mm Female VSWR 1.3:1 to 50 GHz</p> <p>Model No: <a href="#">PE9675</a></p>	PRICE	1-4	\$566.37	5-9	\$538.05	10-24	\$509.73	25+	\$487.08	 <table border="1"> <thead> <tr><th>PRICE</th></tr> </thead> <tbody> <tr><td>1-9</td><td>\$303.36</td></tr> <tr><td>10-24</td><td>\$288.19</td></tr> <tr><td>25-49</td><td>\$273.02</td></tr> <tr><td>50+</td><td>\$260.89</td></tr> </tbody> </table> <p>2.4mm Female to Full Detent Mini SMP Male VSWR 1.25:1 to 50 GHz</p> <p>Model No: <a href="#">PE91122</a></p>	PRICE	1-9	\$303.36	10-24	\$288.19	25-49	\$273.02	50+	\$260.89	 <table border="1"> <thead> <tr><th>PRICE</th></tr> </thead> <tbody> <tr><td>1-9</td><td>\$285.24</td></tr> <tr><td>10-24</td><td>\$270.98</td></tr> <tr><td>25-49</td><td>\$256.72</td></tr> <tr><td>50+</td><td>\$245.31</td></tr> </tbody> </table> <p>2.4mm Female to Mini SMP Female VSWR 1.25:1 to 50 GHz</p> <p>Model No: <a href="#">PE91123</a></p>	PRICE	1-9	\$285.24	10-24	\$270.98	25-49	\$256.72	50+	\$245.31
PRICE																																																		
1-9	\$239.04																																																	
10-24	\$227.09																																																	
25-49	\$215.14																																																	
50+	\$205.57																																																	
PRICE																																																		
1-4	\$569.84																																																	
5-9	\$541.35																																																	
10-24	\$512.86																																																	
25+	\$490.06																																																	
PRICE																																																		
1-4	\$566.37																																																	
5-9	\$538.05																																																	
10-24	\$509.73																																																	
25+	\$487.08																																																	
PRICE																																																		
1-9	\$303.36																																																	
10-24	\$288.19																																																	
25-49	\$273.02																																																	
50+	\$260.89																																																	
PRICE																																																		
1-9	\$285.24																																																	
10-24	\$270.98																																																	
25-49	\$256.72																																																	
50+	\$245.31																																																	
3	 <table border="1"> <thead> <tr><th>PRICE</th></tr> </thead> <tbody> <tr><td>1-9</td><td>\$236.42</td></tr> <tr><td>10-24</td><td>\$224.60</td></tr> <tr><td>25-49</td><td>\$212.78</td></tr> <tr><td>50+</td><td>\$203.32</td></tr> </tbody> </table> <p>PRECISION 2.4mm Female to N Male VSWR 1.15:1 to 18 GHz</p> <p>Model No: <a href="#">PE9503</a></p>	PRICE	1-9	\$236.42	10-24	\$224.60	25-49	\$212.78	50+	\$203.32	 <table border="1"> <thead> <tr><th>PRICE</th></tr> </thead> <tbody> <tr><td>1-9</td><td>\$231.78</td></tr> <tr><td>10-24</td><td>\$220.19</td></tr> <tr><td>25-49</td><td>\$208.60</td></tr> <tr><td>50+</td><td>\$199.33</td></tr> </tbody> </table> <p>PRECISION 2.4mm Female to N Female VSWR 1.15:1 to 18 GHz</p> <p>Model No: <a href="#">PE9502</a></p>	PRICE	1-9	\$231.78	10-24	\$220.19	25-49	\$208.60	50+	\$199.33	 <table border="1"> <thead> <tr><th>PRICE</th></tr> </thead> <tbody> <tr><td>1-9</td><td>\$287.53</td></tr> <tr><td>10-24</td><td>\$273.15</td></tr> <tr><td>25-49</td><td>\$258.78</td></tr> <tr><td>50+</td><td>\$247.28</td></tr> </tbody> </table> <p>2.4mm Female to SMP Male VSWR 1.25:1 to 40 GHz</p> <p>Model No: <a href="#">PE91048</a></p>	PRICE	1-9	\$287.53	10-24	\$273.15	25-49	\$258.78	50+	\$247.28	 <table border="1"> <thead> <tr><th>PRICE</th></tr> </thead> <tbody> <tr><td>1-9</td><td>\$313.41</td></tr> <tr><td>10-24</td><td>\$297.74</td></tr> <tr><td>25-49</td><td>\$282.07</td></tr> <tr><td>50+</td><td>\$269.53</td></tr> </tbody> </table> <p>2.4mm Female to SMP Female VSWR 1.25:1 to 40 GHz</p> <p>Model No: <a href="#">PE91055</a></p>	PRICE	1-9	\$313.41	10-24	\$297.74	25-49	\$282.07	50+	\$269.53	<div style="background-color: black; color: white; padding: 10px; text-align: center;"> <p><b>2.4mm NMD Between Series</b></p> <p>→</p> </div>									
PRICE																																																		
1-9	\$236.42																																																	
10-24	\$224.60																																																	
25-49	\$212.78																																																	
50+	\$203.32																																																	
PRICE																																																		
1-9	\$231.78																																																	
10-24	\$220.19																																																	
25-49	\$208.60																																																	
50+	\$199.33																																																	
PRICE																																																		
1-9	\$287.53																																																	
10-24	\$273.15																																																	
25-49	\$258.78																																																	
50+	\$247.28																																																	
PRICE																																																		
1-9	\$313.41																																																	
10-24	\$297.74																																																	
25-49	\$282.07																																																	
50+	\$269.53																																																	
4	 <table border="1"> <thead> <tr><th>PRICE</th></tr> </thead> <tbody> <tr><td>1-9</td><td>\$334.04</td></tr> <tr><td>10-24</td><td>\$317.34</td></tr> <tr><td>25-49</td><td>\$300.64</td></tr> <tr><td>50+</td><td>\$287.27</td></tr> </tbody> </table> <p>2.4mm NMD Female to 2.4mm Female Max. Freq. 50 GHz</p> <p>Model No: <a href="#">PE91145</a></p>	PRICE	1-9	\$334.04	10-24	\$317.34	25-49	\$300.64	50+	\$287.27	 <table border="1"> <thead> <tr><th>PRICE</th></tr> </thead> <tbody> <tr><td>1-9</td><td>\$316.15</td></tr> <tr><td>10-24</td><td>\$300.34</td></tr> <tr><td>25-49</td><td>\$284.54</td></tr> <tr><td>50+</td><td>\$271.89</td></tr> </tbody> </table> <p>Ruggedized 2.4mm NMD Female to SMA Female VSWR 1.2:1 to 27 GHz</p> <p>Model No: <a href="#">PE91146</a></p>	PRICE	1-9	\$316.15	10-24	\$300.34	25-49	\$284.54	50+	\$271.89	<div style="background-color: black; color: white; padding: 10px; text-align: center;"> <p><b>2.92mm In-Series</b></p> <p>→</p> </div>	 <table border="1"> <thead> <tr><th>PRICE</th></tr> </thead> <tbody> <tr><td>1-9</td><td>\$193.36</td></tr> <tr><td>10-24</td><td>\$183.69</td></tr> <tr><td>25-49</td><td>\$174.02</td></tr> <tr><td>50+</td><td>\$166.29</td></tr> </tbody> </table> <p>2.92mm Male to 2.92mm Male VSWR 1.25:1 to 40 GHz</p> <p>Model No: <a href="#">PE9436</a></p>	PRICE	1-9	\$193.36	10-24	\$183.69	25-49	\$174.02	50+	\$166.29	 <table border="1"> <thead> <tr><th>PRICE</th></tr> </thead> <tbody> <tr><td>1-9</td><td>\$302.57</td></tr> <tr><td>10-24</td><td>\$287.44</td></tr> <tr><td>25-49</td><td>\$272.31</td></tr> <tr><td>50+</td><td>\$260.21</td></tr> </tbody> </table> <p>2.92mm Male to 2.92mm Male Right Angle VSWR 1.3:1 to 40 GHz</p> <p>Model No: <a href="#">PE9645</a></p>	PRICE	1-9	\$302.57	10-24	\$287.44	25-49	\$272.31	50+	\$260.21									
PRICE																																																		
1-9	\$334.04																																																	
10-24	\$317.34																																																	
25-49	\$300.64																																																	
50+	\$287.27																																																	
PRICE																																																		
1-9	\$316.15																																																	
10-24	\$300.34																																																	
25-49	\$284.54																																																	
50+	\$271.89																																																	
PRICE																																																		
1-9	\$193.36																																																	
10-24	\$183.69																																																	
25-49	\$174.02																																																	
50+	\$166.29																																																	
PRICE																																																		
1-9	\$302.57																																																	
10-24	\$287.44																																																	
25-49	\$272.31																																																	
50+	\$260.21																																																	
5	 <table border="1"> <thead> <tr><th>PRICE</th></tr> </thead> <tbody> <tr><td>1-9</td><td>\$198.91</td></tr> <tr><td>10-24</td><td>\$188.96</td></tr> <tr><td>25-49</td><td>\$179.02</td></tr> <tr><td>50+</td><td>\$171.06</td></tr> </tbody> </table> <p>2.92mm Male to 2.92mm Female VSWR 1.25:1 to 40 GHz</p> <p>Model No: <a href="#">PE9437</a></p>	PRICE	1-9	\$198.91	10-24	\$188.96	25-49	\$179.02	50+	\$171.06	 <table border="1"> <thead> <tr><th>PRICE</th></tr> </thead> <tbody> <tr><td>1-24</td><td>\$76.40</td></tr> <tr><td>25-49</td><td>\$72.58</td></tr> <tr><td>50-99</td><td>\$68.76</td></tr> <tr><td>100+</td><td>\$65.70</td></tr> </tbody> </table> <p>2.92mm Female to 2.92mm Female VSWR 1.25:1 to 40 GHz</p> <p>Model No: <a href="#">PE91510</a></p>	PRICE	1-24	\$76.40	25-49	\$72.58	50-99	\$68.76	100+	\$65.70	 <table border="1"> <thead> <tr><th>PRICE</th></tr> </thead> <tbody> <tr><td>1-9</td><td>\$194.80</td></tr> <tr><td>10-24</td><td>\$185.06</td></tr> <tr><td>25-49</td><td>\$175.32</td></tr> <tr><td>50+</td><td>\$167.53</td></tr> </tbody> </table> <p>2.92mm Female to 2.92mm Female VSWR 1.25:1 to 40 GHz</p> <p>Model No: <a href="#">PE9438</a></p>	PRICE	1-9	\$194.80	10-24	\$185.06	25-49	\$175.32	50+	\$167.53	 <table border="1"> <thead> <tr><th>PRICE</th></tr> </thead> <tbody> <tr><td>1-9</td><td>\$134.89</td></tr> <tr><td>10-24</td><td>\$128.15</td></tr> <tr><td>25-49</td><td>\$121.40</td></tr> <tr><td>50+</td><td>\$116.01</td></tr> </tbody> </table> <p>2.92mm Female to 2.92mm Female Bulkhead-Mounting Hole B02 VSWR 1.25:1 to 40 GHz</p> <p>Model No: <a href="#">PE9647</a></p>	PRICE	1-9	\$134.89	10-24	\$128.15	25-49	\$121.40	50+	\$116.01	 <table border="1"> <thead> <tr><th>PRICE</th></tr> </thead> <tbody> <tr><td>1-24</td><td>\$101.61</td></tr> <tr><td>25-49</td><td>\$97.55</td></tr> <tr><td>50-99</td><td>\$94.50</td></tr> <tr><td>100+</td><td>\$92.47</td></tr> </tbody> </table> <p>2.92mm Female to 2.92mm Female 4 Hole Flange VSWR 1.25:1 to 40 GHz</p> <p>Model No: <a href="#">PE91113</a></p>	PRICE	1-24	\$101.61	25-49	\$97.55	50-99	\$94.50	100+	\$92.47
PRICE																																																		
1-9	\$198.91																																																	
10-24	\$188.96																																																	
25-49	\$179.02																																																	
50+	\$171.06																																																	
PRICE																																																		
1-24	\$76.40																																																	
25-49	\$72.58																																																	
50-99	\$68.76																																																	
100+	\$65.70																																																	
PRICE																																																		
1-9	\$194.80																																																	
10-24	\$185.06																																																	
25-49	\$175.32																																																	
50+	\$167.53																																																	
PRICE																																																		
1-9	\$134.89																																																	
10-24	\$128.15																																																	
25-49	\$121.40																																																	
50+	\$116.01																																																	
PRICE																																																		
1-24	\$101.61																																																	
25-49	\$97.55																																																	
50-99	\$94.50																																																	
100+	\$92.47																																																	
6	 <table border="1"> <thead> <tr><th>PRICE</th></tr> </thead> <tbody> <tr><td>1-9</td><td>\$220.70</td></tr> <tr><td>10-24</td><td>\$209.67</td></tr> <tr><td>25-49</td><td>\$198.63</td></tr> <tr><td>50+</td><td>\$189.80</td></tr> </tbody> </table> <p>2.92mm Female to 2.92mm Female 4 Hole Flange VSWR 1.35:1 to 40 GHz</p> <p>Model No: <a href="#">PE9648</a></p>	PRICE	1-9	\$220.70	10-24	\$209.67	25-49	\$198.63	50+	\$189.80	<div style="background-color: black; color: white; padding: 10px; text-align: center;"> <p><b>2.92mm Between Series</b></p> <p>→</p> </div>	 <table border="1"> <thead> <tr><th>PRICE</th></tr> </thead> <tbody> <tr><td>1-4</td><td>\$534.25</td></tr> <tr><td>5-9</td><td>\$507.54</td></tr> <tr><td>10-24</td><td>\$480.83</td></tr> <tr><td>25+</td><td>\$459.46</td></tr> </tbody> </table> <p>2.92mm Male to 1.85mm Male VSWR 1.25:1 to 40 GHz</p> <p>Model No: <a href="#">PE9667</a></p>	PRICE	1-4	\$534.25	5-9	\$507.54	10-24	\$480.83	25+	\$459.46	 <table border="1"> <thead> <tr><th>PRICE</th></tr> </thead> <tbody> <tr><td>1-4</td><td>\$534.25</td></tr> <tr><td>5-9</td><td>\$507.54</td></tr> <tr><td>10-24</td><td>\$480.83</td></tr> <tr><td>25+</td><td>\$459.46</td></tr> </tbody> </table> <p>2.92mm Male to 1.85mm Female VSWR 1.25:1 to 40 GHz</p> <p>Model No: <a href="#">PE9666</a></p>	PRICE	1-4	\$534.25	5-9	\$507.54	10-24	\$480.83	25+	\$459.46	 <table border="1"> <thead> <tr><th>PRICE</th></tr> </thead> <tbody> <tr><td>1-9</td><td>\$239.40</td></tr> <tr><td>10-24</td><td>\$227.43</td></tr> <tr><td>25-49</td><td>\$215.46</td></tr> <tr><td>50+</td><td>\$205.88</td></tr> </tbody> </table> <p>2.92mm Male to 2.4mm Male VSWR 1.15:1 to 40 GHz</p> <p>Model No: <a href="#">PE91298</a></p>	PRICE	1-9	\$239.40	10-24	\$227.43	25-49	\$215.46	50+	\$205.88									
PRICE																																																		
1-9	\$220.70																																																	
10-24	\$209.67																																																	
25-49	\$198.63																																																	
50+	\$189.80																																																	
PRICE																																																		
1-4	\$534.25																																																	
5-9	\$507.54																																																	
10-24	\$480.83																																																	
25+	\$459.46																																																	
PRICE																																																		
1-4	\$534.25																																																	
5-9	\$507.54																																																	
10-24	\$480.83																																																	
25+	\$459.46																																																	
PRICE																																																		
1-9	\$239.40																																																	
10-24	\$227.43																																																	
25-49	\$215.46																																																	
50+	\$205.88																																																	
7	 <table border="1"> <thead> <tr><th>PRICE</th></tr> </thead> <tbody> <tr><td>1-9</td><td>\$161.34</td></tr> <tr><td>10-24</td><td>\$153.27</td></tr> <tr><td>25-49</td><td>\$145.21</td></tr> <tr><td>50+</td><td>\$138.75</td></tr> </tbody> </table> <p>2.92mm Male to 2.4mm Male VSWR 1.3:1 to 40 GHz</p> <p>Model No: <a href="#">PE9457</a></p>	PRICE	1-9	\$161.34	10-24	\$153.27	25-49	\$145.21	50+	\$138.75	 <table border="1"> <thead> <tr><th>PRICE</th></tr> </thead> <tbody> <tr><td>1-9</td><td>\$237.13</td></tr> <tr><td>10-24</td><td>\$225.27</td></tr> <tr><td>25-49</td><td>\$213.42</td></tr> <tr><td>NEW 50+</td><td>\$203.93</td></tr> </tbody> </table> <p>2.92mm Male to 2.4mm Female VSWR 1.25:1 to 40 GHz</p> <p>Model No: <a href="#">PE91450</a></p>	PRICE	1-9	\$237.13	10-24	\$225.27	25-49	\$213.42	NEW 50+	\$203.93	 <table border="1"> <thead> <tr><th>PRICE</th></tr> </thead> <tbody> <tr><td>1-9</td><td>\$146.82</td></tr> <tr><td>10-24</td><td>\$139.48</td></tr> <tr><td>25-49</td><td>\$132.14</td></tr> <tr><td>50+</td><td>\$126.27</td></tr> </tbody> </table> <p>2.92mm Male to 2.4mm Female VSWR 1.3:1 to 40 GHz</p> <p>Model No: <a href="#">PE9455</a></p>	PRICE	1-9	\$146.82	10-24	\$139.48	25-49	\$132.14	50+	\$126.27	 <table border="1"> <thead> <tr><th>PRICE</th></tr> </thead> <tbody> <tr><td>1-9</td><td>\$327.08</td></tr> <tr><td>10-24</td><td>\$314.00</td></tr> <tr><td>25-49</td><td>\$304.18</td></tr> <tr><td>50+</td><td>\$297.64</td></tr> </tbody> </table> <p>2.92mm Male to 2.92mm Female Radius Right Angle VSWR 1.5:1 to 40 GHz</p> <p>Model No: <a href="#">PE91070</a></p>	PRICE	1-9	\$327.08	10-24	\$314.00	25-49	\$304.18	50+	\$297.64	 <table border="1"> <thead> <tr><th>PRICE</th></tr> </thead> <tbody> <tr><td>1-24</td><td>\$260.02</td></tr> <tr><td>25-49</td><td>\$241.82</td></tr> <tr><td>50-99</td><td>\$223.62</td></tr> <tr><td>100+</td><td>\$208.02</td></tr> </tbody> </table> <p>2.92mm Male to 3.5mm Male Right Angle VSWR 1.25:1 to 34.5 GHz</p> <p>Model No: <a href="#">PE91165</a></p>	PRICE	1-24	\$260.02	25-49	\$241.82	50-99	\$223.62	100+	\$208.02
PRICE																																																		
1-9	\$161.34																																																	
10-24	\$153.27																																																	
25-49	\$145.21																																																	
50+	\$138.75																																																	
PRICE																																																		
1-9	\$237.13																																																	
10-24	\$225.27																																																	
25-49	\$213.42																																																	
NEW 50+	\$203.93																																																	
PRICE																																																		
1-9	\$146.82																																																	
10-24	\$139.48																																																	
25-49	\$132.14																																																	
50+	\$126.27																																																	
PRICE																																																		
1-9	\$327.08																																																	
10-24	\$314.00																																																	
25-49	\$304.18																																																	
50+	\$297.64																																																	
PRICE																																																		
1-24	\$260.02																																																	
25-49	\$241.82																																																	
50-99	\$223.62																																																	
100+	\$208.02																																																	



Technical Support  
+1 (949) 261-1920



Same-Day Shipping,  
Even Custom Cable Assemblies

# ADAPTERS

See Adapter Locator on Pages 8-13

See Page 369 for Mounting Holes

Adapters

See Our Website For Current Pricing & Real-Time Stock Availability!

	A	B	C	D	E																																													
1	 <table border="1"> <thead> <tr><th>PRICE</th></tr> </thead> <tbody> <tr><td>1-24</td><td>\$260.02</td></tr> <tr><td>25-49</td><td>\$241.82</td></tr> <tr><td>50-99</td><td>\$223.62</td></tr> <tr><td>100+</td><td>\$208.02</td></tr> </tbody> </table> <p>2.92mm Male to 3.5mm Female Right Angle VSWR 1.25:1 to 34.5 GHz</p> <p>Model No: <a href="#">PE91168</a></p>	PRICE	1-24	\$260.02	25-49	\$241.82	50-99	\$223.62	100+	\$208.02	 <table border="1"> <thead> <tr><th>PRICE</th></tr> </thead> <tbody> <tr><td>1-9</td><td>\$444.80</td></tr> <tr><td>10-24</td><td>\$427.01</td></tr> <tr><td>25-49</td><td>\$413.66</td></tr> <tr><td>50+</td><td>\$404.77</td></tr> </tbody> </table> <p>2.92mm Male to 7mm Sexless VSWR 1.1:1 to 18 GHz</p> <p>Model No: <a href="#">PE9460</a></p>	PRICE	1-9	\$444.80	10-24	\$427.01	25-49	\$413.66	50+	\$404.77	 <table border="1"> <thead> <tr><th>PRICE</th></tr> </thead> <tbody> <tr><td>1-9</td><td>\$240.95</td></tr> <tr><td>10-24</td><td>\$231.31</td></tr> <tr><td>25-49</td><td>\$224.08</td></tr> <tr><td>50+</td><td>\$219.26</td></tr> </tbody> </table> <p>2.92mm Male to Mini SMP Male VSWR 1.25:1 to 40 GHz</p> <p>Model No: <a href="#">PE91124</a></p>	PRICE	1-9	\$240.95	10-24	\$231.31	25-49	\$224.08	50+	\$219.26	 <table border="1"> <thead> <tr><th>PRICE</th></tr> </thead> <tbody> <tr><td>1-9</td><td>\$240.95</td></tr> <tr><td>10-24</td><td>\$231.31</td></tr> <tr><td>25-49</td><td>\$224.08</td></tr> <tr><td>50+</td><td>\$219.26</td></tr> </tbody> </table> <p>2.92mm Male to Smooth Bore Mini SMP Male VSWR 1.4:1 to 40 GHz</p> <p>Model No: <a href="#">PE91125</a></p>	PRICE	1-9	\$240.95	10-24	\$231.31	25-49	\$224.08	50+	\$219.26	 <table border="1"> <thead> <tr><th>PRICE</th></tr> </thead> <tbody> <tr><td>1-9</td><td>\$240.95</td></tr> <tr><td>10-24</td><td>\$231.31</td></tr> <tr><td>25-49</td><td>\$224.08</td></tr> <tr><td>50+</td><td>\$219.26</td></tr> </tbody> </table> <p>2.92mm Male to Mini SMP Female VSWR 1.4:1 to 40 GHz</p> <p>Model No: <a href="#">PE91126</a></p>	PRICE	1-9	\$240.95	10-24	\$231.31	25-49	\$224.08	50+	\$219.26
PRICE																																																		
1-24	\$260.02																																																	
25-49	\$241.82																																																	
50-99	\$223.62																																																	
100+	\$208.02																																																	
PRICE																																																		
1-9	\$444.80																																																	
10-24	\$427.01																																																	
25-49	\$413.66																																																	
50+	\$404.77																																																	
PRICE																																																		
1-9	\$240.95																																																	
10-24	\$231.31																																																	
25-49	\$224.08																																																	
50+	\$219.26																																																	
PRICE																																																		
1-9	\$240.95																																																	
10-24	\$231.31																																																	
25-49	\$224.08																																																	
50+	\$219.26																																																	
PRICE																																																		
1-9	\$240.95																																																	
10-24	\$231.31																																																	
25-49	\$224.08																																																	
50+	\$219.26																																																	
2	 <table border="1"> <thead> <tr><th>PRICE</th></tr> </thead> <tbody> <tr><td>1-9</td><td>\$241.72</td></tr> <tr><td>10-24</td><td>\$229.63</td></tr> <tr><td>25-49</td><td>\$217.55</td></tr> <tr><td>50+</td><td>\$207.88</td></tr> </tbody> </table> <p>PRECISION 2.92mm Male to N Male VSWR 1.15:1 to 18 GHz</p> <p>Model No: <a href="#">PE9661</a></p>	PRICE	1-9	\$241.72	10-24	\$229.63	25-49	\$217.55	50+	\$207.88	 <table border="1"> <thead> <tr><th>PRICE</th></tr> </thead> <tbody> <tr><td>1-9</td><td>\$329.98</td></tr> <tr><td>10-24</td><td>\$313.48</td></tr> <tr><td>25-49</td><td>\$296.98</td></tr> <tr><td>50+</td><td>\$283.78</td></tr> </tbody> </table> <p>PRECISION 2.92mm Male to N Female VSWR 1.15:1 to 18 GHz</p> <p>Model No: <a href="#">PE9662</a></p>	PRICE	1-9	\$329.98	10-24	\$313.48	25-49	\$296.98	50+	\$283.78	 <table border="1"> <thead> <tr><th>PRICE</th></tr> </thead> <tbody> <tr><td>1-4</td><td>\$602.60</td></tr> <tr><td>5-9</td><td>\$572.47</td></tr> <tr><td>10-24</td><td>\$542.34</td></tr> <tr><td>25+</td><td>\$518.24</td></tr> </tbody> </table> <p>2.92mm Female to 1.85mm Male VSWR 1.25:1 to 40 GHz</p> <p>Model No: <a href="#">PE9665</a></p>	PRICE	1-4	\$602.60	5-9	\$572.47	10-24	\$542.34	25+	\$518.24	 <table border="1"> <thead> <tr><th>PRICE</th></tr> </thead> <tbody> <tr><td>1-4</td><td>\$525.39</td></tr> <tr><td>5-9</td><td>\$499.12</td></tr> <tr><td>10-24</td><td>\$472.85</td></tr> <tr><td>25+</td><td>\$451.84</td></tr> </tbody> </table> <p>2.92mm Female to 1.85mm Female VSWR 1.25:1 to 40 GHz</p> <p>Model No: <a href="#">PE9668</a></p>	PRICE	1-4	\$525.39	5-9	\$499.12	10-24	\$472.85	25+	\$451.84	 <table border="1"> <thead> <tr><th>PRICE</th></tr> </thead> <tbody> <tr><td>1-9</td><td>\$265.59</td></tr> <tr><td>10-24</td><td>\$252.31</td></tr> <tr><td>25-49</td><td>\$239.03</td></tr> <tr><td>50+</td><td>\$228.41</td></tr> </tbody> </table> <p>NEW 2.92mm Female to 2.4mm Male VSWR 1.25:1 to 40 GHz</p> <p>Model No: <a href="#">PE91451</a></p>	PRICE	1-9	\$265.59	10-24	\$252.31	25-49	\$239.03	50+	\$228.41
PRICE																																																		
1-9	\$241.72																																																	
10-24	\$229.63																																																	
25-49	\$217.55																																																	
50+	\$207.88																																																	
PRICE																																																		
1-9	\$329.98																																																	
10-24	\$313.48																																																	
25-49	\$296.98																																																	
50+	\$283.78																																																	
PRICE																																																		
1-4	\$602.60																																																	
5-9	\$572.47																																																	
10-24	\$542.34																																																	
25+	\$518.24																																																	
PRICE																																																		
1-4	\$525.39																																																	
5-9	\$499.12																																																	
10-24	\$472.85																																																	
25+	\$451.84																																																	
PRICE																																																		
1-9	\$265.59																																																	
10-24	\$252.31																																																	
25-49	\$239.03																																																	
50+	\$228.41																																																	
3	 <table border="1"> <thead> <tr><th>PRICE</th></tr> </thead> <tbody> <tr><td>1-9</td><td>\$138.53</td></tr> <tr><td>10-24</td><td>\$131.60</td></tr> <tr><td>25-49</td><td>\$124.68</td></tr> <tr><td>50+</td><td>\$119.14</td></tr> </tbody> </table> <p>2.92mm Female to 2.4mm Male VSWR 1.25:1 to 40 GHz</p> <p>Model No: <a href="#">PE9454</a></p>	PRICE	1-9	\$138.53	10-24	\$131.60	25-49	\$124.68	50+	\$119.14	 <table border="1"> <thead> <tr><th>PRICE</th></tr> </thead> <tbody> <tr><td>1-9</td><td>\$237.13</td></tr> <tr><td>10-24</td><td>\$225.27</td></tr> <tr><td>25-49</td><td>\$213.42</td></tr> <tr><td>50+</td><td>\$203.93</td></tr> </tbody> </table> <p>2.92mm Female to 2.4mm Female VSWR 1.15:1 to 40 GHz</p> <p>Model No: <a href="#">PE91295</a></p>	PRICE	1-9	\$237.13	10-24	\$225.27	25-49	\$213.42	50+	\$203.93	 <table border="1"> <thead> <tr><th>PRICE</th></tr> </thead> <tbody> <tr><td>1-24</td><td>\$237.13</td></tr> <tr><td>25-49</td><td>\$220.53</td></tr> <tr><td>50-99</td><td>\$203.93</td></tr> <tr><td>100+</td><td>\$189.70</td></tr> </tbody> </table> <p>NEW 2.92mm Female to 2.4mm Female VSWR 1.2:1 to 40 GHz</p> <p>Model No: <a href="#">PE91499</a></p>	PRICE	1-24	\$237.13	25-49	\$220.53	50-99	\$203.93	100+	\$189.70	 <table border="1"> <thead> <tr><th>PRICE</th></tr> </thead> <tbody> <tr><td>1-9</td><td>\$152.42</td></tr> <tr><td>10-24</td><td>\$144.80</td></tr> <tr><td>25-49</td><td>\$137.18</td></tr> <tr><td>50+</td><td>\$131.08</td></tr> </tbody> </table> <p>2.92mm Female to 2.4mm Female VSWR 1.3:1 to 40 GHz</p> <p>Model No: <a href="#">PE9456</a></p>	PRICE	1-9	\$152.42	10-24	\$144.80	25-49	\$137.18	50+	\$131.08	 <table border="1"> <thead> <tr><th>PRICE</th></tr> </thead> <tbody> <tr><td>1-24</td><td>\$260.02</td></tr> <tr><td>25-49</td><td>\$241.82</td></tr> <tr><td>50-99</td><td>\$223.62</td></tr> <tr><td>100+</td><td>\$208.02</td></tr> </tbody> </table> <p>2.92mm Female to 3.5mm Male Right Angle VSWR 1.25:1 to 34.5 GHz</p> <p>Model No: <a href="#">PE91166</a></p>	PRICE	1-24	\$260.02	25-49	\$241.82	50-99	\$223.62	100+	\$208.02
PRICE																																																		
1-9	\$138.53																																																	
10-24	\$131.60																																																	
25-49	\$124.68																																																	
50+	\$119.14																																																	
PRICE																																																		
1-9	\$237.13																																																	
10-24	\$225.27																																																	
25-49	\$213.42																																																	
50+	\$203.93																																																	
PRICE																																																		
1-24	\$237.13																																																	
25-49	\$220.53																																																	
50-99	\$203.93																																																	
100+	\$189.70																																																	
PRICE																																																		
1-9	\$152.42																																																	
10-24	\$144.80																																																	
25-49	\$137.18																																																	
50+	\$131.08																																																	
PRICE																																																		
1-24	\$260.02																																																	
25-49	\$241.82																																																	
50-99	\$223.62																																																	
100+	\$208.02																																																	
4	 <table border="1"> <thead> <tr><th>PRICE</th></tr> </thead> <tbody> <tr><td>1-9</td><td>\$220.01</td></tr> <tr><td>10-24</td><td>\$209.01</td></tr> <tr><td>25-49</td><td>\$198.01</td></tr> <tr><td>50+</td><td>\$189.21</td></tr> </tbody> </table> <p>2.92mm Female to 3.5mm Female VSWR 1.25:1 to 34 GHz</p> <p>Model No: <a href="#">PE9660</a></p>	PRICE	1-9	\$220.01	10-24	\$209.01	25-49	\$198.01	50+	\$189.21	 <table border="1"> <thead> <tr><th>PRICE</th></tr> </thead> <tbody> <tr><td>1-24</td><td>\$232.15</td></tr> <tr><td>25-49</td><td>\$215.90</td></tr> <tr><td>50-99</td><td>\$199.65</td></tr> <tr><td>100+</td><td>\$185.72</td></tr> </tbody> </table> <p>2.92mm Female to 3.5mm Female Right Angle VSWR 1.25:1 to 34.5 GHz</p> <p>Model No: <a href="#">PE91167</a></p>	PRICE	1-24	\$232.15	25-49	\$215.90	50-99	\$199.65	100+	\$185.72	 <table border="1"> <thead> <tr><th>PRICE</th></tr> </thead> <tbody> <tr><td>1-9</td><td>\$498.18</td></tr> <tr><td>10-24</td><td>\$473.27</td></tr> <tr><td>25-49</td><td>\$448.36</td></tr> <tr><td>50+</td><td>\$428.43</td></tr> </tbody> </table> <p>PRECISION 2.92mm Female to 7mm Sexless VSWR 1.1:1 to 18 GHz</p> <p>Model No: <a href="#">PE9461</a></p>	PRICE	1-9	\$498.18	10-24	\$473.27	25-49	\$448.36	50+	\$428.43	 <table border="1"> <thead> <tr><th>PRICE</th></tr> </thead> <tbody> <tr><td>1-4</td><td>\$642.09</td></tr> <tr><td>5-9</td><td>\$609.99</td></tr> <tr><td>10-24</td><td>\$577.88</td></tr> <tr><td>25+</td><td>\$552.20</td></tr> </tbody> </table> <p>2.92mm Female to Mini SMP Male VSWR 1.3:1 to 40 GHz</p> <p>Model No: <a href="#">PE9781</a></p>	PRICE	1-4	\$642.09	5-9	\$609.99	10-24	\$577.88	25+	\$552.20	 <table border="1"> <thead> <tr><th>PRICE</th></tr> </thead> <tbody> <tr><td>1-9</td><td>\$240.95</td></tr> <tr><td>10-24</td><td>\$231.31</td></tr> <tr><td>25-49</td><td>\$224.08</td></tr> <tr><td>50+</td><td>\$219.26</td></tr> </tbody> </table> <p>2.92mm Female to Full Detent Mini SMP Male VSWR 1.35:1 to 40 GHz</p> <p>Model No: <a href="#">PE91127</a></p>	PRICE	1-9	\$240.95	10-24	\$231.31	25-49	\$224.08	50+	\$219.26
PRICE																																																		
1-9	\$220.01																																																	
10-24	\$209.01																																																	
25-49	\$198.01																																																	
50+	\$189.21																																																	
PRICE																																																		
1-24	\$232.15																																																	
25-49	\$215.90																																																	
50-99	\$199.65																																																	
100+	\$185.72																																																	
PRICE																																																		
1-9	\$498.18																																																	
10-24	\$473.27																																																	
25-49	\$448.36																																																	
50+	\$428.43																																																	
PRICE																																																		
1-4	\$642.09																																																	
5-9	\$609.99																																																	
10-24	\$577.88																																																	
25+	\$552.20																																																	
PRICE																																																		
1-9	\$240.95																																																	
10-24	\$231.31																																																	
25-49	\$224.08																																																	
50+	\$219.26																																																	
5	 <table border="1"> <thead> <tr><th>PRICE</th></tr> </thead> <tbody> <tr><td>1-9</td><td>\$262.77</td></tr> <tr><td>10-24</td><td>\$252.26</td></tr> <tr><td>25-49</td><td>\$244.38</td></tr> <tr><td>50+</td><td>\$239.12</td></tr> </tbody> </table> <p>2.92mm Female to Smooth Bore Mini SMP Male VSWR 1.35:1 to 40 GHz</p> <p>Model No: <a href="#">PE91128</a></p>	PRICE	1-9	\$262.77	10-24	\$252.26	25-49	\$244.38	50+	\$239.12	 <table border="1"> <thead> <tr><th>PRICE</th></tr> </thead> <tbody> <tr><td>1-4</td><td>\$742.40</td></tr> <tr><td>5-9</td><td>\$705.28</td></tr> <tr><td>10-24</td><td>\$668.16</td></tr> <tr><td>25+</td><td>\$638.46</td></tr> </tbody> </table> <p>2.92mm Female to Mini SMP Female VSWR 1.3:1 to 40 GHz</p> <p>Model No: <a href="#">PE9782</a></p>	PRICE	1-4	\$742.40	5-9	\$705.28	10-24	\$668.16	25+	\$638.46	 <table border="1"> <thead> <tr><th>PRICE</th></tr> </thead> <tbody> <tr><td>1-9</td><td>\$218.62</td></tr> <tr><td>10-24</td><td>\$207.69</td></tr> <tr><td>25-49</td><td>\$196.76</td></tr> <tr><td>50+</td><td>\$188.01</td></tr> </tbody> </table> <p>PRECISION 2.92mm Female to N Male VSWR 1.15:1 to 18 GHz</p> <p>Model No: <a href="#">PE9663</a></p>	PRICE	1-9	\$218.62	10-24	\$207.69	25-49	\$196.76	50+	\$188.01	 <table border="1"> <thead> <tr><th>PRICE</th></tr> </thead> <tbody> <tr><td>1-9</td><td>\$222.42</td></tr> <tr><td>10-24</td><td>\$211.30</td></tr> <tr><td>25-49</td><td>\$200.18</td></tr> <tr><td>50+</td><td>\$191.28</td></tr> </tbody> </table> <p>PRECISION 2.92mm Female to N Female VSWR 1.15:1 to 18 GHz</p> <p>Model No: <a href="#">PE9664</a></p>	PRICE	1-9	\$222.42	10-24	\$211.30	25-49	\$200.18	50+	\$191.28	 <table border="1"> <thead> <tr><th>PRICE</th></tr> </thead> <tbody> <tr><td>1-9</td><td>\$213.57</td></tr> <tr><td>10-24</td><td>\$202.89</td></tr> <tr><td>25-49</td><td>\$192.21</td></tr> <tr><td>50+</td><td>\$183.67</td></tr> </tbody> </table> <p>2.92mm Female to SMP Female VSWR 1.25:1 to 40 GHz</p> <p>Model No: <a href="#">PE91060</a></p>	PRICE	1-9	\$213.57	10-24	\$202.89	25-49	\$192.21	50+	\$183.67
PRICE																																																		
1-9	\$262.77																																																	
10-24	\$252.26																																																	
25-49	\$244.38																																																	
50+	\$239.12																																																	
PRICE																																																		
1-4	\$742.40																																																	
5-9	\$705.28																																																	
10-24	\$668.16																																																	
25+	\$638.46																																																	
PRICE																																																		
1-9	\$218.62																																																	
10-24	\$207.69																																																	
25-49	\$196.76																																																	
50+	\$188.01																																																	
PRICE																																																		
1-9	\$222.42																																																	
10-24	\$211.30																																																	
25-49	\$200.18																																																	
50+	\$191.28																																																	
PRICE																																																		
1-9	\$213.57																																																	
10-24	\$202.89																																																	
25-49	\$192.21																																																	
50+	\$183.67																																																	
6	 <table border="1"> <thead> <tr><th>PRICE</th></tr> </thead> <tbody> <tr><td>1-9</td><td>\$217.58</td></tr> <tr><td>10-24</td><td>\$206.70</td></tr> <tr><td>25-49</td><td>\$195.82</td></tr> <tr><td>50+</td><td>\$187.12</td></tr> </tbody> </table> <p>2.92mm Female to SSMA Male VSWR 1.25:1 to 40 GHz</p> <p>Model No: <a href="#">PE9768</a></p>	PRICE	1-9	\$217.58	10-24	\$206.70	25-49	\$195.82	50+	\$187.12	<p><b>3.5mm In-Series</b></p> 		 <table border="1"> <thead> <tr><th>PRICE</th></tr> </thead> <tbody> <tr><td>1-9</td><td>\$191.44</td></tr> <tr><td>10-24</td><td>\$181.87</td></tr> <tr><td>25-49</td><td>\$172.30</td></tr> <tr><td>50+</td><td>\$164.64</td></tr> </tbody> </table> <p>3.5mm Male to 3.5mm Male VSWR 1.25:1 to 34.5 GHz</p> <p>Model No: <a href="#">PE9330</a></p>	PRICE	1-9	\$191.44	10-24	\$181.87	25-49	\$172.30	50+	\$164.64	 <table border="1"> <thead> <tr><th>PRICE</th></tr> </thead> <tbody> <tr><td>1-24</td><td>\$260.02</td></tr> <tr><td>25-49</td><td>\$241.82</td></tr> <tr><td>50-99</td><td>\$223.62</td></tr> <tr><td>100+</td><td>\$208.02</td></tr> </tbody> </table> <p>3.5mm Male to 3.5mm Male Right Angle VSWR 1.25:1 to 34.5 GHz</p> <p>Model No: <a href="#">PE91169</a></p>	PRICE	1-24	\$260.02	25-49	\$241.82	50-99	\$223.62	100+	\$208.02	 <table border="1"> <thead> <tr><th>PRICE</th></tr> </thead> <tbody> <tr><td>1-9</td><td>\$191.44</td></tr> <tr><td>10-24</td><td>\$181.87</td></tr> <tr><td>25-49</td><td>\$172.30</td></tr> <tr><td>50+</td><td>\$164.64</td></tr> </tbody> </table> <p>3.5mm Male to 3.5mm Female VSWR 1.25:1 to 34.5 GHz</p> <p>Model No: <a href="#">PE9332</a></p>	PRICE	1-9	\$191.44	10-24	\$181.87	25-49	\$172.30	50+	\$164.64								
PRICE																																																		
1-9	\$217.58																																																	
10-24	\$206.70																																																	
25-49	\$195.82																																																	
50+	\$187.12																																																	
PRICE																																																		
1-9	\$191.44																																																	
10-24	\$181.87																																																	
25-49	\$172.30																																																	
50+	\$164.64																																																	
PRICE																																																		
1-24	\$260.02																																																	
25-49	\$241.82																																																	
50-99	\$223.62																																																	
100+	\$208.02																																																	
PRICE																																																		
1-9	\$191.44																																																	
10-24	\$181.87																																																	
25-49	\$172.30																																																	
50+	\$164.64																																																	
7	 <table border="1"> <thead> <tr><th>PRICE</th></tr> </thead> <tbody> <tr><td>1-9</td><td>\$154.96</td></tr> <tr><td>10-24</td><td>\$147.21</td></tr> <tr><td>25-49</td><td>\$139.46</td></tr> <tr><td>50+</td><td>\$133.27</td></tr> </tbody> </table> <p>3.5mm Female to 3.5mm Female VSWR 1.25:1 to 34.5 GHz</p> <p>Model No: <a href="#">PE9331</a></p>	PRICE	1-9	\$154.96	10-24	\$147.21	25-49	\$139.46	50+	\$133.27	 <table border="1"> <thead> <tr><th>PRICE</th></tr> </thead> <tbody> <tr><td>1-9</td><td>\$171.19</td></tr> <tr><td>10-24</td><td>\$162.63</td></tr> <tr><td>25-49</td><td>\$154.07</td></tr> <tr><td>50+</td><td>\$147.22</td></tr> </tbody> </table> <p>3.5mm Female to 3.5mm Female Bulkhead-Mounting Hole B06 VSWR 1.25:1 to 34.5 GHz</p> <p>Model No: <a href="#">PE9678</a></p>	PRICE	1-9	\$171.19	10-24	\$162.63	25-49	\$154.07	50+	\$147.22	 <table border="1"> <thead> <tr><th>PRICE</th></tr> </thead> <tbody> <tr><td>1-9</td><td>\$233.47</td></tr> <tr><td>10-24</td><td>\$221.80</td></tr> <tr><td>25-49</td><td>\$210.12</td></tr> <tr><td>50+</td><td>\$200.78</td></tr> </tbody> </table> <p>3.5mm Female to 3.5mm Female 4 Hole Flange-Mounting Hole A01 VSWR 1.25:1 to 34.5 GHz</p> <p>Model No: <a href="#">PE9676</a></p>	PRICE	1-9	\$233.47	10-24	\$221.80	25-49	\$210.12	50+	\$200.78	<p><b>3.5mm Between Series</b></p> 		 <table border="1"> <thead> <tr><th>PRICE</th></tr> </thead> <tbody> <tr><td>1-9</td><td>\$223.14</td></tr> <tr><td>10-24</td><td>\$211.98</td></tr> <tr><td>25-49</td><td>\$200.83</td></tr> <tr><td>50+</td><td>\$191.90</td></tr> </tbody> </table> <p>3.5mm Male to 1.85mm Male VSWR 1.3:1 to 34 GHz</p> <p>Model No: <a href="#">PE9746</a></p>	PRICE	1-9	\$223.14	10-24	\$211.98	25-49	\$200.83	50+	\$191.90								
PRICE																																																		
1-9	\$154.96																																																	
10-24	\$147.21																																																	
25-49	\$139.46																																																	
50+	\$133.27																																																	
PRICE																																																		
1-9	\$171.19																																																	
10-24	\$162.63																																																	
25-49	\$154.07																																																	
50+	\$147.22																																																	
PRICE																																																		
1-9	\$233.47																																																	
10-24	\$221.80																																																	
25-49	\$210.12																																																	
50+	\$200.78																																																	
PRICE																																																		
1-9	\$223.14																																																	
10-24	\$211.98																																																	
25-49	\$200.83																																																	
50+	\$191.90																																																	

# ADAPTERS

See Adapter Locator on Pages 8-13

See Page 369 for Mounting Holes

Adapters

See Our Website For Current Pricing & Real-Time Stock Availability!

	A	B	C	D	E																																													
1	 <table border="1"> <thead> <tr> <th>PRICE</th> </tr> </thead> <tbody> <tr><td>1-9</td><td>\$223.14</td></tr> <tr><td>10-24</td><td>\$211.98</td></tr> <tr><td>25-49</td><td>\$200.83</td></tr> <tr><td>50+</td><td>\$191.90</td></tr> </tbody> </table> <p>3.5mm Male to 1.85mm Female VSWR 1.3:1 to 34 GHz Model No: <a href="#">PE9745</a></p>	PRICE	1-9	\$223.14	10-24	\$211.98	25-49	\$200.83	50+	\$191.90	 <table border="1"> <thead> <tr> <th>PRICE</th> </tr> </thead> <tbody> <tr><td>1-9</td><td>\$271.40</td></tr> <tr><td>10-24</td><td>\$257.83</td></tr> <tr><td>25-49</td><td>\$244.26</td></tr> <tr><td>50+</td><td>\$233.40</td></tr> </tbody> </table> <p>3.5mm Male to 2.4mm Male VSWR 1.15:1 to 34 GHz Model No: <a href="#">PE91294</a></p>	PRICE	1-9	\$271.40	10-24	\$257.83	25-49	\$244.26	50+	\$233.40	 <table border="1"> <thead> <tr> <th>PRICE</th> </tr> </thead> <tbody> <tr><td>1-9</td><td>\$216.37</td></tr> <tr><td>10-24</td><td>\$205.55</td></tr> <tr><td>25-49</td><td>\$194.73</td></tr> <tr><td>50+</td><td>\$186.08</td></tr> </tbody> </table> <p>3.5mm Male to 2.4mm Male VSWR 1.25:1 to 34 GHz Model No: <a href="#">PE9649</a></p>	PRICE	1-9	\$216.37	10-24	\$205.55	25-49	\$194.73	50+	\$186.08	 <table border="1"> <thead> <tr> <th>PRICE</th> </tr> </thead> <tbody> <tr><td>1-9</td><td>\$216.37</td></tr> <tr><td>10-24</td><td>\$205.55</td></tr> <tr><td>25-49</td><td>\$194.73</td></tr> <tr><td>50+</td><td>\$186.08</td></tr> </tbody> </table> <p>3.5mm Male to 2.4mm Female VSWR 1.25:1 to 34 GHz Model No: <a href="#">PE9651</a></p>	PRICE	1-9	\$216.37	10-24	\$205.55	25-49	\$194.73	50+	\$186.08	 <table border="1"> <thead> <tr> <th>PRICE</th> </tr> </thead> <tbody> <tr><td>1-9</td><td>\$220.01</td></tr> <tr><td>10-24</td><td>\$209.01</td></tr> <tr><td>25-49</td><td>\$198.01</td></tr> <tr><td>50+</td><td>\$189.21</td></tr> </tbody> </table> <p>3.5mm Male to 2.92mm Female VSWR 1.25:1 to 34 GHz Model No: <a href="#">PE9658</a></p>	PRICE	1-9	\$220.01	10-24	\$209.01	25-49	\$198.01	50+	\$189.21
PRICE																																																		
1-9	\$223.14																																																	
10-24	\$211.98																																																	
25-49	\$200.83																																																	
50+	\$191.90																																																	
PRICE																																																		
1-9	\$271.40																																																	
10-24	\$257.83																																																	
25-49	\$244.26																																																	
50+	\$233.40																																																	
PRICE																																																		
1-9	\$216.37																																																	
10-24	\$205.55																																																	
25-49	\$194.73																																																	
50+	\$186.08																																																	
PRICE																																																		
1-9	\$216.37																																																	
10-24	\$205.55																																																	
25-49	\$194.73																																																	
50+	\$186.08																																																	
PRICE																																																		
1-9	\$220.01																																																	
10-24	\$209.01																																																	
25-49	\$198.01																																																	
50+	\$189.21																																																	
2	 <table border="1"> <thead> <tr> <th>PRICE</th> </tr> </thead> <tbody> <tr><td>1-9</td><td>\$305.82</td></tr> <tr><td>10-24</td><td>\$290.53</td></tr> <tr><td>25-49</td><td>\$275.24</td></tr> <tr><td>50+</td><td>\$263.01</td></tr> </tbody> </table> <p>PRECISION 3.5mm Male to 7mm Sexless VSWR 1.15:1 to 18 GHz Model No: <a href="#">PE9326</a></p>	PRICE	1-9	\$305.82	10-24	\$290.53	25-49	\$275.24	50+	\$263.01	 <table border="1"> <thead> <tr> <th>PRICE</th> </tr> </thead> <tbody> <tr><td>1-9</td><td>\$185.77</td></tr> <tr><td>10-24</td><td>\$176.48</td></tr> <tr><td>25-49</td><td>\$167.19</td></tr> <tr><td>50+</td><td>\$159.76</td></tr> </tbody> </table> <p>PRECISION 3.5mm Male to N Male VSWR 1.15:1 to 18 GHz Model No: <a href="#">PE9322</a></p>	PRICE	1-9	\$185.77	10-24	\$176.48	25-49	\$167.19	50+	\$159.76	 <table border="1"> <thead> <tr> <th>PRICE</th> </tr> </thead> <tbody> <tr><td>1-9</td><td>\$179.14</td></tr> <tr><td>10-24</td><td>\$170.18</td></tr> <tr><td>25-49</td><td>\$161.23</td></tr> <tr><td>50+</td><td>\$154.06</td></tr> </tbody> </table> <p>PRECISION 3.5mm Male to N Female VSWR 1.15:1 to 18 GHz Model No: <a href="#">PE9324</a></p>	PRICE	1-9	\$179.14	10-24	\$170.18	25-49	\$161.23	50+	\$154.06	 <table border="1"> <thead> <tr> <th>PRICE</th> </tr> </thead> <tbody> <tr><td>1-9</td><td>\$217.17</td></tr> <tr><td>10-24</td><td>\$206.31</td></tr> <tr><td>25-49</td><td>\$195.45</td></tr> <tr><td>50+</td><td>\$186.77</td></tr> </tbody> </table> <p>3.5mm Female to 1.85mm Female VSWR 1.3:1 to 34 GHz Model No: <a href="#">PE9748</a></p>	PRICE	1-9	\$217.17	10-24	\$206.31	25-49	\$195.45	50+	\$186.77	 <table border="1"> <thead> <tr> <th>PRICE</th> </tr> </thead> <tbody> <tr><td>1-9</td><td>\$271.40</td></tr> <tr><td>10-24</td><td>\$257.83</td></tr> <tr><td>25-49</td><td>\$244.26</td></tr> <tr><td>50+</td><td>\$233.40</td></tr> </tbody> </table> <p>3.5mm Female to 2.4mm Male VSWR 1.25:1 to 34 GHz Model No: <a href="#">PE91292</a></p>	PRICE	1-9	\$271.40	10-24	\$257.83	25-49	\$244.26	50+	\$233.40
PRICE																																																		
1-9	\$305.82																																																	
10-24	\$290.53																																																	
25-49	\$275.24																																																	
50+	\$263.01																																																	
PRICE																																																		
1-9	\$185.77																																																	
10-24	\$176.48																																																	
25-49	\$167.19																																																	
50+	\$159.76																																																	
PRICE																																																		
1-9	\$179.14																																																	
10-24	\$170.18																																																	
25-49	\$161.23																																																	
50+	\$154.06																																																	
PRICE																																																		
1-9	\$217.17																																																	
10-24	\$206.31																																																	
25-49	\$195.45																																																	
50+	\$186.77																																																	
PRICE																																																		
1-9	\$271.40																																																	
10-24	\$257.83																																																	
25-49	\$244.26																																																	
50+	\$233.40																																																	
3	 <table border="1"> <thead> <tr> <th>PRICE</th> </tr> </thead> <tbody> <tr><td>1-9</td><td>\$220.96</td></tr> <tr><td>10-24</td><td>\$209.91</td></tr> <tr><td>25-49</td><td>\$198.86</td></tr> <tr><td>50+</td><td>\$190.03</td></tr> </tbody> </table> <p>3.5mm Female to 2.4mm Male VSWR 1.25:1 to 34 GHz Model No: <a href="#">PE9650</a></p>	PRICE	1-9	\$220.96	10-24	\$209.91	25-49	\$198.86	50+	\$190.03	 <table border="1"> <thead> <tr> <th>PRICE</th> </tr> </thead> <tbody> <tr><td>1-9</td><td>\$271.40</td></tr> <tr><td>10-24</td><td>\$257.83</td></tr> <tr><td>25-49</td><td>\$244.26</td></tr> <tr><td>50+</td><td>\$233.40</td></tr> </tbody> </table> <p>3.5mm Female to 2.4mm Female VSWR 1.15:1 to 34 GHz Model No: <a href="#">PE91291</a></p>	PRICE	1-9	\$271.40	10-24	\$257.83	25-49	\$244.26	50+	\$233.40	 <table border="1"> <thead> <tr> <th>PRICE</th> </tr> </thead> <tbody> <tr><td>1-9</td><td>\$194.30</td></tr> <tr><td>10-24</td><td>\$184.59</td></tr> <tr><td>25-49</td><td>\$174.87</td></tr> <tr><td>50+</td><td>\$167.10</td></tr> </tbody> </table> <p>3.5mm Female to 2.4mm Female VSWR 1.25:1 to 34 GHz Model No: <a href="#">PE9652</a></p>	PRICE	1-9	\$194.30	10-24	\$184.59	25-49	\$174.87	50+	\$167.10	 <table border="1"> <thead> <tr> <th>PRICE</th> </tr> </thead> <tbody> <tr><td>1-9</td><td>\$216.37</td></tr> <tr><td>10-24</td><td>\$205.55</td></tr> <tr><td>25-49</td><td>\$194.73</td></tr> <tr><td>50+</td><td>\$186.08</td></tr> </tbody> </table> <p>3.5mm Female to 2.92mm Male VSWR 1.25:1 to 34.5 GHz Model No: <a href="#">PE9659</a></p>	PRICE	1-9	\$216.37	10-24	\$205.55	25-49	\$194.73	50+	\$186.08	 <table border="1"> <thead> <tr> <th>PRICE</th> </tr> </thead> <tbody> <tr><td>1-9</td><td>\$433.54</td></tr> <tr><td>10-24</td><td>\$411.86</td></tr> <tr><td>25-49</td><td>\$390.19</td></tr> <tr><td>50+</td><td>\$372.84</td></tr> </tbody> </table> <p>PRECISION 3.5mm Female to 7mm Sexless VSWR 1.15:1 to 18 GHz Model No: <a href="#">PE9325</a></p>	PRICE	1-9	\$433.54	10-24	\$411.86	25-49	\$390.19	50+	\$372.84
PRICE																																																		
1-9	\$220.96																																																	
10-24	\$209.91																																																	
25-49	\$198.86																																																	
50+	\$190.03																																																	
PRICE																																																		
1-9	\$271.40																																																	
10-24	\$257.83																																																	
25-49	\$244.26																																																	
50+	\$233.40																																																	
PRICE																																																		
1-9	\$194.30																																																	
10-24	\$184.59																																																	
25-49	\$174.87																																																	
50+	\$167.10																																																	
PRICE																																																		
1-9	\$216.37																																																	
10-24	\$205.55																																																	
25-49	\$194.73																																																	
50+	\$186.08																																																	
PRICE																																																		
1-9	\$433.54																																																	
10-24	\$411.86																																																	
25-49	\$390.19																																																	
50+	\$372.84																																																	
4	 <table border="1"> <thead> <tr> <th>PRICE</th> </tr> </thead> <tbody> <tr><td>1-9</td><td>\$174.54</td></tr> <tr><td>10-24</td><td>\$165.81</td></tr> <tr><td>25-49</td><td>\$157.09</td></tr> <tr><td>50+</td><td>\$150.10</td></tr> </tbody> </table> <p>PRECISION 3.5mm Female to N Male VSWR 1.15:1 to 18 GHz Model No: <a href="#">PE9321</a></p>	PRICE	1-9	\$174.54	10-24	\$165.81	25-49	\$157.09	50+	\$150.10	 <table border="1"> <thead> <tr> <th>PRICE</th> </tr> </thead> <tbody> <tr><td>1-9</td><td>\$176.74</td></tr> <tr><td>10-24</td><td>\$167.90</td></tr> <tr><td>25-49</td><td>\$159.07</td></tr> <tr><td>50+</td><td>\$152.00</td></tr> </tbody> </table> <p>PRECISION 3.5mm Female to N Female VSWR 1.15:1 to 18 GHz Model No: <a href="#">PE9323</a></p>	PRICE	1-9	\$176.74	10-24	\$167.90	25-49	\$159.07	50+	\$152.00	<p><b>3.5mm NMD Between Series</b></p> 		 <table border="1"> <thead> <tr> <th>PRICE</th> </tr> </thead> <tbody> <tr><td>1-9</td><td>\$334.04</td></tr> <tr><td>10-24</td><td>\$317.34</td></tr> <tr><td>25-49</td><td>\$300.64</td></tr> <tr><td>50+</td><td>\$287.27</td></tr> </tbody> </table> <p>3.5mm NMD Female to 2.4mm Female VSWR 1.25:1 to 33 GHz Model No: <a href="#">PE91148</a></p>	PRICE	1-9	\$334.04	10-24	\$317.34	25-49	\$300.64	50+	\$287.27	 <table border="1"> <thead> <tr> <th>PRICE</th> </tr> </thead> <tbody> <tr><td>1-9</td><td>\$301.25</td></tr> <tr><td>10-24</td><td>\$286.19</td></tr> <tr><td>25-49</td><td>\$271.13</td></tr> <tr><td>50+</td><td>\$259.08</td></tr> </tbody> </table> <p>Ruggedized 3.5mm NMD Female to SMA Female Max. Freq. 27 GHz Model No: <a href="#">PE91147</a></p>	PRICE	1-9	\$301.25	10-24	\$286.19	25-49	\$271.13	50+	\$259.08								
PRICE																																																		
1-9	\$174.54																																																	
10-24	\$165.81																																																	
25-49	\$157.09																																																	
50+	\$150.10																																																	
PRICE																																																		
1-9	\$176.74																																																	
10-24	\$167.90																																																	
25-49	\$159.07																																																	
50+	\$152.00																																																	
PRICE																																																		
1-9	\$334.04																																																	
10-24	\$317.34																																																	
25-49	\$300.64																																																	
50+	\$287.27																																																	
PRICE																																																		
1-9	\$301.25																																																	
10-24	\$286.19																																																	
25-49	\$271.13																																																	
50+	\$259.08																																																	
5	<p><b>7mm Between Series</b></p> 		 <table border="1"> <thead> <tr> <th>PRICE</th> </tr> </thead> <tbody> <tr><td>1-9</td><td>\$485.03</td></tr> <tr><td>10-24</td><td>\$465.63</td></tr> <tr><td>25-49</td><td>\$451.08</td></tr> <tr><td>50+</td><td>\$441.38</td></tr> </tbody> </table> <p>PRECISION 7mm Sexless to BNC Male VSWR 1.15:1 to 8 GHz Model No: <a href="#">PE9221</a></p>	PRICE	1-9	\$485.03	10-24	\$465.63	25-49	\$451.08	50+	\$441.38	 <table border="1"> <thead> <tr> <th>PRICE</th> </tr> </thead> <tbody> <tr><td>1-9</td><td>\$343.09</td></tr> <tr><td>10-24</td><td>\$325.94</td></tr> <tr><td>25-49</td><td>\$308.78</td></tr> <tr><td>50+</td><td>\$295.06</td></tr> </tbody> </table> <p>PRECISION 7mm Sexless to BNC Female VSWR 1.15:1 to 8 GHz Model No: <a href="#">PE9220</a></p>	PRICE	1-9	\$343.09	10-24	\$325.94	25-49	\$308.78	50+	\$295.06	<p><b>4.1/9.5 Mini DIN In-Series</b></p> 		 <table border="1"> <thead> <tr> <th>PRICE</th> </tr> </thead> <tbody> <tr><td>1-24</td><td>\$65.21</td></tr> <tr><td>25-49</td><td>\$61.95</td></tr> <tr><td>50-99</td><td>\$58.69</td></tr> <tr><td>100+</td><td>\$56.08</td></tr> </tbody> </table> <p>4.1/9.5 Mini DIN Male to 4.1/9.5 Mini DIN Male VSWR 1.25:1 to 6 GHz Model No: <a href="#">PE91194</a></p>	PRICE	1-24	\$65.21	25-49	\$61.95	50-99	\$58.69	100+	\$56.08																
PRICE																																																		
1-9	\$485.03																																																	
10-24	\$465.63																																																	
25-49	\$451.08																																																	
50+	\$441.38																																																	
PRICE																																																		
1-9	\$343.09																																																	
10-24	\$325.94																																																	
25-49	\$308.78																																																	
50+	\$295.06																																																	
PRICE																																																		
1-24	\$65.21																																																	
25-49	\$61.95																																																	
50-99	\$58.69																																																	
100+	\$56.08																																																	
6	 <table border="1"> <thead> <tr> <th>PRICE</th> </tr> </thead> <tbody> <tr><td>1-24</td><td>\$48.10</td></tr> <tr><td>25-49</td><td>\$45.70</td></tr> <tr><td>50-99</td><td>\$43.29</td></tr> <tr><td>100+</td><td>\$41.37</td></tr> </tbody> </table> <p>4.1/9.5 Mini DIN Male to 4.1/9.5 Mini DIN Male VSWR 1.3:1 to 6 GHz Model No: <a href="#">PE91231</a></p>	PRICE	1-24	\$48.10	25-49	\$45.70	50-99	\$43.29	100+	\$41.37	 <table border="1"> <thead> <tr> <th>PRICE</th> </tr> </thead> <tbody> <tr><td>1-24</td><td>\$65.21</td></tr> <tr><td>25-49</td><td>\$61.95</td></tr> <tr><td>50-99</td><td>\$58.69</td></tr> <tr><td>100+</td><td>\$56.08</td></tr> </tbody> </table> <p>4.1/9.5 Mini DIN Male to 4.1/9.5 Mini DIN Female VSWR 1.25:1 to 6 GHz Model No: <a href="#">PE91195</a></p>	PRICE	1-24	\$65.21	25-49	\$61.95	50-99	\$58.69	100+	\$56.08	 <table border="1"> <thead> <tr> <th>PRICE</th> </tr> </thead> <tbody> <tr><td>1-24</td><td>\$30.46</td></tr> <tr><td>25-49</td><td>\$28.94</td></tr> <tr><td>50-99</td><td>\$27.41</td></tr> <tr><td>100+</td><td>\$26.20</td></tr> </tbody> </table> <p>4.1/9.5 Mini DIN Male to 4.1/9.5 Mini DIN Female VSWR 1.3:1 to 6 GHz Model No: <a href="#">PE91232</a></p>	PRICE	1-24	\$30.46	25-49	\$28.94	50-99	\$27.41	100+	\$26.20	 <table border="1"> <thead> <tr> <th>PRICE</th> </tr> </thead> <tbody> <tr><td>1-24</td><td>\$28.73</td></tr> <tr><td>25-49</td><td>\$27.29</td></tr> <tr><td>50-99</td><td>\$25.86</td></tr> <tr><td>100+</td><td>\$24.71</td></tr> </tbody> </table> <p>4.1/9.5 Mini DIN Female to 4.1/9.5 Mini DIN Female VSWR 1.3:1 to 6 GHz Model No: <a href="#">PE91233</a></p>	PRICE	1-24	\$28.73	25-49	\$27.29	50-99	\$25.86	100+	\$24.71	 <table border="1"> <thead> <tr> <th>PRICE</th> </tr> </thead> <tbody> <tr><td>1-24</td><td>\$77.90</td></tr> <tr><td>25-49</td><td>\$74.01</td></tr> <tr><td>50-99</td><td>\$70.11</td></tr> <tr><td>100+</td><td>\$66.99</td></tr> </tbody> </table> <p>4.1/9.5 Mini DIN Female to 4.1/9.5 Mini DIN Female Bulkhead VSWR 1.25:1 to 6 GHz Model No: <a href="#">PE91197</a></p>	PRICE	1-24	\$77.90	25-49	\$74.01	50-99	\$70.11	100+	\$66.99
PRICE																																																		
1-24	\$48.10																																																	
25-49	\$45.70																																																	
50-99	\$43.29																																																	
100+	\$41.37																																																	
PRICE																																																		
1-24	\$65.21																																																	
25-49	\$61.95																																																	
50-99	\$58.69																																																	
100+	\$56.08																																																	
PRICE																																																		
1-24	\$30.46																																																	
25-49	\$28.94																																																	
50-99	\$27.41																																																	
100+	\$26.20																																																	
PRICE																																																		
1-24	\$28.73																																																	
25-49	\$27.29																																																	
50-99	\$25.86																																																	
100+	\$24.71																																																	
PRICE																																																		
1-24	\$77.90																																																	
25-49	\$74.01																																																	
50-99	\$70.11																																																	
100+	\$66.99																																																	
7	 <table border="1"> <thead> <tr> <th>PRICE</th> </tr> </thead> <tbody> <tr><td>1-24</td><td>\$30.67</td></tr> <tr><td>25-49</td><td>\$29.14</td></tr> <tr><td>50-99</td><td>\$27.60</td></tr> <tr><td>100+</td><td>\$26.38</td></tr> </tbody> </table> <p>4.1/9.5 Mini DIN Female to 4.1/9.5 Mini DIN Female Bulkhead VSWR 1.3:1 to 6 GHz Model No: <a href="#">PE91234</a></p>	PRICE	1-24	\$30.67	25-49	\$29.14	50-99	\$27.60	100+	\$26.38	<p><b>4.1/9.5 Mini DIN Between Series</b></p> 		 <table border="1"> <thead> <tr> <th>PRICE</th> </tr> </thead> <tbody> <tr><td>1-24</td><td>\$56.01</td></tr> <tr><td>25-49</td><td>\$53.21</td></tr> <tr><td>50-99</td><td>\$50.41</td></tr> <tr><td>100+</td><td>\$48.17</td></tr> </tbody> </table> <p>4.1/9.5 Mini DIN Male to N Male VSWR 1.25:1 to 6 GHz Model No: <a href="#">PE91216</a></p>	PRICE	1-24	\$56.01	25-49	\$53.21	50-99	\$50.41	100+	\$48.17	 <table border="1"> <thead> <tr> <th>PRICE</th> </tr> </thead> <tbody> <tr><td>1-24</td><td>\$61.61</td></tr> <tr><td>25-49</td><td>\$58.53</td></tr> <tr><td>50-99</td><td>\$55.45</td></tr> <tr><td>100+</td><td>\$52.98</td></tr> </tbody> </table> <p>4.1/9.5 Mini DIN Male to N Male VSWR 1.3:1 to 6 GHz Model No: <a href="#">PE91253</a></p>	PRICE	1-24	\$61.61	25-49	\$58.53	50-99	\$55.45	100+	\$52.98	 <table border="1"> <thead> <tr> <th>PRICE</th> </tr> </thead> <tbody> <tr><td>1-24</td><td>\$59.07</td></tr> <tr><td>25-49</td><td>\$56.12</td></tr> <tr><td>50-99</td><td>\$53.16</td></tr> <tr><td>100+</td><td>\$50.80</td></tr> </tbody> </table> <p>Low PIM 4.1/9.5 Mini DIN Male to N Male VSWR 1.25:1 to 6 GHz Model No: <a href="#">PE91092</a></p>	PRICE	1-24	\$59.07	25-49	\$56.12	50-99	\$53.16	100+	\$50.80								
PRICE																																																		
1-24	\$30.67																																																	
25-49	\$29.14																																																	
50-99	\$27.60																																																	
100+	\$26.38																																																	
PRICE																																																		
1-24	\$56.01																																																	
25-49	\$53.21																																																	
50-99	\$50.41																																																	
100+	\$48.17																																																	
PRICE																																																		
1-24	\$61.61																																																	
25-49	\$58.53																																																	
50-99	\$55.45																																																	
100+	\$52.98																																																	
PRICE																																																		
1-24	\$59.07																																																	
25-49	\$56.12																																																	
50-99	\$53.16																																																	
100+	\$50.80																																																	



Technical Support  
+1 (949) 261-1920



Same-Day Shipping,  
Even Custom Cable Assemblies

































# ADAPTERS

See Adapter Locator on Pages 8-13

See Page 369 for Mounting Holes

Adapters

See Our Website For Current Pricing & Real-Time Stock Availability!































	A	B	C	D	E																																																		
1	 <table border="1"> <thead> <tr> <th colspan="2">PRICE</th> </tr> </thead> <tbody> <tr> <td>1-24</td> <td>\$61.62</td> </tr> <tr> <td>25-49</td> <td>\$58.54</td> </tr> <tr> <td>50-99</td> <td>\$55.46</td> </tr> <tr> <td>100+</td> <td>\$52.99</td> </tr> </tbody> </table> <p>4.1/9.5 Mini DIN Male to N Female VSWR 1.25:1 to 6 GHz Model No: <a href="#">PE91217</a></p>	PRICE		1-24	\$61.62	25-49	\$58.54	50-99	\$55.46	100+	\$52.99	 <table border="1"> <thead> <tr> <th colspan="2">PRICE</th> </tr> </thead> <tbody> <tr> <td>1-24</td> <td>\$64.01</td> </tr> <tr> <td>25-49</td> <td>\$60.81</td> </tr> <tr> <td>50-99</td> <td>\$57.61</td> </tr> <tr> <td>100+</td> <td>\$55.05</td> </tr> </tbody> </table> <p>4.1/9.5 Mini DIN Male to N Female VSWR 1.3:1 to 6 GHz Model No: <a href="#">PE91254</a></p>	PRICE		1-24	\$64.01	25-49	\$60.81	50-99	\$57.61	100+	\$55.05	 <table border="1"> <thead> <tr> <th colspan="2">PRICE</th> </tr> </thead> <tbody> <tr> <td>1-24</td> <td>\$57.46</td> </tr> <tr> <td>25-49</td> <td>\$54.59</td> </tr> <tr> <td>50-99</td> <td>\$51.71</td> </tr> <tr> <td>100+</td> <td>\$49.42</td> </tr> </tbody> </table> <p>Low PIM 4.1/9.5 Mini DIN Male to N Female VSWR 1.25:1 to 6 GHz Model No: <a href="#">PE91093</a></p>	PRICE		1-24	\$57.46	25-49	\$54.59	50-99	\$51.71	100+	\$49.42	 <table border="1"> <thead> <tr> <th colspan="2">PRICE</th> </tr> </thead> <tbody> <tr> <td>1-24</td> <td>\$56.01</td> </tr> <tr> <td>25-49</td> <td>\$53.21</td> </tr> <tr> <td>50-99</td> <td>\$50.41</td> </tr> <tr> <td>100+</td> <td>\$48.17</td> </tr> </tbody> </table> <p>4.1/9.5 Mini DIN Female to N Male VSWR 1.25:1 to 6 GHz Model No: <a href="#">PE91219</a></p>	PRICE		1-24	\$56.01	25-49	\$53.21	50-99	\$50.41	100+	\$48.17	 <table border="1"> <thead> <tr> <th colspan="2">PRICE</th> </tr> </thead> <tbody> <tr> <td>1-24</td> <td>\$70.42</td> </tr> <tr> <td>25-49</td> <td>\$66.90</td> </tr> <tr> <td>50-99</td> <td>\$63.38</td> </tr> <tr> <td>100+</td> <td>\$60.56</td> </tr> </tbody> </table> <p>4.1/9.5 Mini DIN Female to N Male VSWR 1.3:1 to 6 GHz Model No: <a href="#">PE91256</a></p>	PRICE		1-24	\$70.42	25-49	\$66.90	50-99	\$63.38	100+	\$60.56
	PRICE																																																						
1-24	\$61.62																																																						
25-49	\$58.54																																																						
50-99	\$55.46																																																						
100+	\$52.99																																																						
PRICE																																																							
1-24	\$64.01																																																						
25-49	\$60.81																																																						
50-99	\$57.61																																																						
100+	\$55.05																																																						
PRICE																																																							
1-24	\$57.46																																																						
25-49	\$54.59																																																						
50-99	\$51.71																																																						
100+	\$49.42																																																						
PRICE																																																							
1-24	\$56.01																																																						
25-49	\$53.21																																																						
50-99	\$50.41																																																						
100+	\$48.17																																																						
PRICE																																																							
1-24	\$70.42																																																						
25-49	\$66.90																																																						
50-99	\$63.38																																																						
100+	\$60.56																																																						
2	 <table border="1"> <thead> <tr> <th colspan="2">PRICE</th> </tr> </thead> <tbody> <tr> <td>1-24</td> <td>\$59.07</td> </tr> <tr> <td>25-49</td> <td>\$56.12</td> </tr> <tr> <td>50-99</td> <td>\$53.16</td> </tr> <tr> <td>100+</td> <td>\$50.80</td> </tr> </tbody> </table> <p>Low PIM 4.1/9.5 Mini DIN Female to N Male VSWR 1.25:1 to 6 GHz Model No: <a href="#">PE91094</a></p>	PRICE		1-24	\$59.07	25-49	\$56.12	50-99	\$53.16	100+	\$50.80	 <table border="1"> <thead> <tr> <th colspan="2">PRICE</th> </tr> </thead> <tbody> <tr> <td>1-24</td> <td>\$56.01</td> </tr> <tr> <td>25-49</td> <td>\$53.21</td> </tr> <tr> <td>50-99</td> <td>\$50.41</td> </tr> <tr> <td>100+</td> <td>\$48.17</td> </tr> </tbody> </table> <p>4.1/9.5 Mini DIN Female to N Female VSWR 1.25:1 to 6 GHz Model No: <a href="#">PE91218</a></p>	PRICE		1-24	\$56.01	25-49	\$53.21	50-99	\$50.41	100+	\$48.17	 <table border="1"> <thead> <tr> <th colspan="2">PRICE</th> </tr> </thead> <tbody> <tr> <td>1-24</td> <td>\$61.61</td> </tr> <tr> <td>25-49</td> <td>\$58.53</td> </tr> <tr> <td>50-99</td> <td>\$55.45</td> </tr> <tr> <td>100+</td> <td>\$52.98</td> </tr> </tbody> </table> <p>4.1/9.5 Mini DIN Female to N Female VSWR 1.3:1 to 6 GHz Model No: <a href="#">PE91255</a></p>	PRICE		1-24	\$61.61	25-49	\$58.53	50-99	\$55.45	100+	\$52.98	 <table border="1"> <thead> <tr> <th colspan="2">PRICE</th> </tr> </thead> <tbody> <tr> <td>1-24</td> <td>\$59.07</td> </tr> <tr> <td>25-49</td> <td>\$56.12</td> </tr> <tr> <td>50-99</td> <td>\$53.16</td> </tr> <tr> <td>100+</td> <td>\$50.80</td> </tr> </tbody> </table> <p>Low PIM 4.1/9.5 Mini DIN Female to N Female VSWR 1.25:1 to 6 GHz Model No: <a href="#">PE91095</a></p>	PRICE		1-24	\$59.07	25-49	\$56.12	50-99	\$53.16	100+	\$50.80	 <table border="1"> <thead> <tr> <th colspan="2">PRICE</th> </tr> </thead> <tbody> <tr> <td>1-24</td> <td>\$69.56</td> </tr> <tr> <td>25-49</td> <td>\$66.08</td> </tr> <tr> <td>50-99</td> <td>\$62.60</td> </tr> <tr> <td>100+</td> <td>\$59.82</td> </tr> </tbody> </table> <p>4.1/9.5 Mini DIN Female to N Female Bulkhead VSWR 1.25:1 to 6 GHz Model No: <a href="#">PE91220</a></p>	PRICE		1-24	\$69.56	25-49	\$66.08	50-99	\$62.60	100+	\$59.82
	PRICE																																																						
1-24	\$59.07																																																						
25-49	\$56.12																																																						
50-99	\$53.16																																																						
100+	\$50.80																																																						
PRICE																																																							
1-24	\$56.01																																																						
25-49	\$53.21																																																						
50-99	\$50.41																																																						
100+	\$48.17																																																						
PRICE																																																							
1-24	\$61.61																																																						
25-49	\$58.53																																																						
50-99	\$55.45																																																						
100+	\$52.98																																																						
PRICE																																																							
1-24	\$59.07																																																						
25-49	\$56.12																																																						
50-99	\$53.16																																																						
100+	\$50.80																																																						
PRICE																																																							
1-24	\$69.56																																																						
25-49	\$66.08																																																						
50-99	\$62.60																																																						
100+	\$59.82																																																						
3	 <table border="1"> <thead> <tr> <th colspan="2">PRICE</th> </tr> </thead> <tbody> <tr> <td>1-24</td> <td>\$79.49</td> </tr> <tr> <td>25-49</td> <td>\$75.52</td> </tr> <tr> <td>50-99</td> <td>\$71.54</td> </tr> <tr> <td>100+</td> <td>\$68.36</td> </tr> </tbody> </table> <p>4.1/9.5 Mini DIN Female to N Female Bulkhead VSWR 1.3:1 to 6 GHz Model No: <a href="#">PE91257</a></p>	PRICE		1-24	\$79.49	25-49	\$75.52	50-99	\$71.54	100+	\$68.36	<div style="background-color: black; color: white; text-align: center; padding: 10px;"> <p><b>4.3</b> <i>Non Constant In-Series</i></p> <p>→</p> </div>	 <table border="1"> <thead> <tr> <th colspan="2">PRICE</th> </tr> </thead> <tbody> <tr> <td>1-24</td> <td>\$35.12</td> </tr> <tr> <td>25-49</td> <td>\$33.36</td> </tr> <tr> <td>50-99</td> <td>\$31.61</td> </tr> <tr> <td>100+</td> <td>\$30.20</td> </tr> </tbody> </table> <p>Low PIM NEW 4.3-10 Male to 4.3-10 Male VSWR 1.25:1 to 6 GHz Model No: <a href="#">PE91466</a></p>	PRICE		1-24	\$35.12	25-49	\$33.36	50-99	\$31.61	100+	\$30.20	 <table border="1"> <thead> <tr> <th colspan="2">PRICE</th> </tr> </thead> <tbody> <tr> <td>1-24</td> <td>\$80.00</td> </tr> <tr> <td>25-49</td> <td>\$76.00</td> </tr> <tr> <td>50-99</td> <td>\$72.00</td> </tr> <tr> <td>100+</td> <td>\$68.80</td> </tr> </tbody> </table> <p>Low PIM NEW 4.3-10 Male to 4.3-10 Male VSWR 1.08:1 to 6 GHz Model No: <a href="#">PE91385</a></p>	PRICE		1-24	\$80.00	25-49	\$76.00	50-99	\$72.00	100+	\$68.80	 <table border="1"> <thead> <tr> <th colspan="2">PRICE</th> </tr> </thead> <tbody> <tr> <td>1-24</td> <td>\$39.69</td> </tr> <tr> <td>25-49</td> <td>\$37.71</td> </tr> <tr> <td>50-99</td> <td>\$35.72</td> </tr> <tr> <td>100+</td> <td>\$34.13</td> </tr> </tbody> </table> <p>Low PIM NEW 4.3-10 Male to 4.3-10 Female VSWR 1.25:1 to 6 GHz Model No: <a href="#">PE91465</a></p>	PRICE		1-24	\$39.69	25-49	\$37.71	50-99	\$35.72	100+	\$34.13										
	PRICE																																																						
1-24	\$79.49																																																						
25-49	\$75.52																																																						
50-99	\$71.54																																																						
100+	\$68.36																																																						
PRICE																																																							
1-24	\$35.12																																																						
25-49	\$33.36																																																						
50-99	\$31.61																																																						
100+	\$30.20																																																						
PRICE																																																							
1-24	\$80.00																																																						
25-49	\$76.00																																																						
50-99	\$72.00																																																						
100+	\$68.80																																																						
PRICE																																																							
1-24	\$39.69																																																						
25-49	\$37.71																																																						
50-99	\$35.72																																																						
100+	\$34.13																																																						
4	 <table border="1"> <thead> <tr> <th colspan="2">PRICE</th> </tr> </thead> <tbody> <tr> <td>1-24</td> <td>\$80.00</td> </tr> <tr> <td>25-49</td> <td>\$76.00</td> </tr> <tr> <td>50-99</td> <td>\$72.00</td> </tr> <tr> <td>100+</td> <td>\$68.80</td> </tr> </tbody> </table> <p>Low PIM NEW 4.3-10 Male to 4.3-10 Female Right Angle VSWR 1.2:1 to 3 GHz Model No: <a href="#">PE91467</a></p>	PRICE		1-24	\$80.00	25-49	\$76.00	50-99	\$72.00	100+	\$68.80	 <table border="1"> <thead> <tr> <th colspan="2">PRICE</th> </tr> </thead> <tbody> <tr> <td>1-24</td> <td>\$81.02</td> </tr> <tr> <td>25-49</td> <td>\$77.78</td> </tr> <tr> <td>50-99</td> <td>\$75.35</td> </tr> <tr> <td>100+</td> <td>\$73.73</td> </tr> </tbody> </table> <p>Low PIM 4.3-10 Male to 4.3-10 Female VSWR 1.08:1 to 6 GHz Model No: <a href="#">PE91387</a></p>	PRICE		1-24	\$81.02	25-49	\$77.78	50-99	\$75.35	100+	\$73.73	 <table border="1"> <thead> <tr> <th colspan="2">PRICE</th> </tr> </thead> <tbody> <tr> <td>1-24</td> <td>\$39.69</td> </tr> <tr> <td>25-49</td> <td>\$37.71</td> </tr> <tr> <td>50-99</td> <td>\$35.72</td> </tr> <tr> <td>100+</td> <td>\$34.13</td> </tr> </tbody> </table> <p>Low PIM NEW 4.3-10 Female to 4.3-10 Female VSWR 1.25:1 to 6 GHz Model No: <a href="#">PE91464</a></p>	PRICE		1-24	\$39.69	25-49	\$37.71	50-99	\$35.72	100+	\$34.13	 <table border="1"> <thead> <tr> <th colspan="2">PRICE</th> </tr> </thead> <tbody> <tr> <td>1-24</td> <td>\$82.65</td> </tr> <tr> <td>25-49</td> <td>\$78.52</td> </tr> <tr> <td>50-99</td> <td>\$74.39</td> </tr> <tr> <td>100+</td> <td>\$71.08</td> </tr> </tbody> </table> <p>Low PIM NEW 4.3-10 Female to 4.3-10 Female VSWR 1.08:1 to 6 GHz Model No: <a href="#">PE91386</a></p>	PRICE		1-24	\$82.65	25-49	\$78.52	50-99	\$74.39	100+	\$71.08	<div style="background-color: black; color: white; text-align: center; padding: 10px;"> <p><b>4.3</b> <i>Non Constant Between Series</i></p> <p>→</p> </div>										
	PRICE																																																						
1-24	\$80.00																																																						
25-49	\$76.00																																																						
50-99	\$72.00																																																						
100+	\$68.80																																																						
PRICE																																																							
1-24	\$81.02																																																						
25-49	\$77.78																																																						
50-99	\$75.35																																																						
100+	\$73.73																																																						
PRICE																																																							
1-24	\$39.69																																																						
25-49	\$37.71																																																						
50-99	\$35.72																																																						
100+	\$34.13																																																						
PRICE																																																							
1-24	\$82.65																																																						
25-49	\$78.52																																																						
50-99	\$74.39																																																						
100+	\$71.08																																																						
5	 <table border="1"> <thead> <tr> <th colspan="2">PRICE</th> </tr> </thead> <tbody> <tr> <td>1-24</td> <td>\$35.12</td> </tr> <tr> <td>25-49</td> <td>\$33.36</td> </tr> <tr> <td>50-99</td> <td>\$31.61</td> </tr> <tr> <td>100+</td> <td>\$30.20</td> </tr> </tbody> </table> <p>Low PIM NEW 4.3-10 Male to N Male VSWR 1.25:1 to 6 GHz Model No: <a href="#">PE91476</a></p>	PRICE		1-24	\$35.12	25-49	\$33.36	50-99	\$31.61	100+	\$30.20	 <table border="1"> <thead> <tr> <th colspan="2">PRICE</th> </tr> </thead> <tbody> <tr> <td>1-24</td> <td>\$48.00</td> </tr> <tr> <td>25-49</td> <td>\$45.60</td> </tr> <tr> <td>50-99</td> <td>\$43.20</td> </tr> <tr> <td>100+</td> <td>\$41.28</td> </tr> </tbody> </table> <p>Low PIM NEW QD 4.3-10 Male to N Male VSWR 1.25:1 to 6 GHz Model No: <a href="#">PE91480</a></p>	PRICE		1-24	\$48.00	25-49	\$45.60	50-99	\$43.20	100+	\$41.28	 <table border="1"> <thead> <tr> <th colspan="2">PRICE</th> </tr> </thead> <tbody> <tr> <td>1-24</td> <td>\$35.12</td> </tr> <tr> <td>25-49</td> <td>\$33.36</td> </tr> <tr> <td>50-99</td> <td>\$31.61</td> </tr> <tr> <td>100+</td> <td>\$30.20</td> </tr> </tbody> </table> <p>Low PIM NEW 4.3-10 Male to N Female VSWR 1.25:1 to 6 GHz Model No: <a href="#">PE91474</a></p>	PRICE		1-24	\$35.12	25-49	\$33.36	50-99	\$31.61	100+	\$30.20	 <table border="1"> <thead> <tr> <th colspan="2">PRICE</th> </tr> </thead> <tbody> <tr> <td>1-24</td> <td>\$35.12</td> </tr> <tr> <td>25-49</td> <td>\$33.36</td> </tr> <tr> <td>50-99</td> <td>\$31.61</td> </tr> <tr> <td>100+</td> <td>\$30.20</td> </tr> </tbody> </table> <p>Low PIM NEW 4.3-10 Male to N Female VSWR 1.25:1 to 6 GHz Model No: <a href="#">PE91477</a></p>	PRICE		1-24	\$35.12	25-49	\$33.36	50-99	\$31.61	100+	\$30.20	 <table border="1"> <thead> <tr> <th colspan="2">PRICE</th> </tr> </thead> <tbody> <tr> <td>1-24</td> <td>\$46.20</td> </tr> <tr> <td>25-49</td> <td>\$43.89</td> </tr> <tr> <td>50-99</td> <td>\$41.58</td> </tr> <tr> <td>100+</td> <td>\$39.73</td> </tr> </tbody> </table> <p>Low PIM NEW QD 4.3-10 Male to N Female VSWR 1.25:1 to 6 GHz Model No: <a href="#">PE91478</a></p>	PRICE		1-24	\$46.20	25-49	\$43.89	50-99	\$41.58	100+	\$39.73
	PRICE																																																						
1-24	\$35.12																																																						
25-49	\$33.36																																																						
50-99	\$31.61																																																						
100+	\$30.20																																																						
PRICE																																																							
1-24	\$48.00																																																						
25-49	\$45.60																																																						
50-99	\$43.20																																																						
100+	\$41.28																																																						
PRICE																																																							
1-24	\$35.12																																																						
25-49	\$33.36																																																						
50-99	\$31.61																																																						
100+	\$30.20																																																						
PRICE																																																							
1-24	\$35.12																																																						
25-49	\$33.36																																																						
50-99	\$31.61																																																						
100+	\$30.20																																																						
PRICE																																																							
1-24	\$46.20																																																						
25-49	\$43.89																																																						
50-99	\$41.58																																																						
100+	\$39.73																																																						
6	 <table border="1"> <thead> <tr> <th colspan="2">PRICE</th> </tr> </thead> <tbody> <tr> <td>1-24</td> <td>\$56.45</td> </tr> <tr> <td>25-49</td> <td>\$53.63</td> </tr> <tr> <td>50-99</td> <td>\$50.81</td> </tr> <tr> <td>100+</td> <td>\$48.55</td> </tr> </tbody> </table> <p>Low PIM NEW 4.3-10 Male to N Female Right Angle VSWR 1.25:1 to 6 GHz Model No: <a href="#">PE91483</a></p>	PRICE		1-24	\$56.45	25-49	\$53.63	50-99	\$50.81	100+	\$48.55	 <table border="1"> <thead> <tr> <th colspan="2">PRICE</th> </tr> </thead> <tbody> <tr> <td>1-24</td> <td>\$84.23</td> </tr> <tr> <td>25-49</td> <td>\$80.02</td> </tr> <tr> <td>50-99</td> <td>\$75.81</td> </tr> <tr> <td>100+</td> <td>\$72.44</td> </tr> </tbody> </table> <p>Low PIM NEW 4.3-10 Male to N Female VSWR 1.08:1 to 6 GHz Model No: <a href="#">PE91389</a></p>	PRICE		1-24	\$84.23	25-49	\$80.02	50-99	\$75.81	100+	\$72.44	 <table border="1"> <thead> <tr> <th colspan="2">PRICE</th> </tr> </thead> <tbody> <tr> <td>1-24</td> <td>\$34.63</td> </tr> <tr> <td>25-49</td> <td>\$32.90</td> </tr> <tr> <td>50-99</td> <td>\$31.17</td> </tr> <tr> <td>100+</td> <td>\$29.78</td> </tr> </tbody> </table> <p>Low PIM NEW 4.3-10 Male to SMA Female VSWR 1.15:1 to 6 GHz Model No: <a href="#">PE91484</a></p>	PRICE		1-24	\$34.63	25-49	\$32.90	50-99	\$31.17	100+	\$29.78	 <table border="1"> <thead> <tr> <th colspan="2">PRICE</th> </tr> </thead> <tbody> <tr> <td>1-24</td> <td>\$41.28</td> </tr> <tr> <td>25-49</td> <td>\$39.22</td> </tr> <tr> <td>50-99</td> <td>\$37.15</td> </tr> <tr> <td>100+</td> <td>\$35.50</td> </tr> </tbody> </table> <p>Low PIM NEW 4.3-10 Female to N Male VSWR 1.25:1 to 6 GHz Model No: <a href="#">PE91479</a></p>	PRICE		1-24	\$41.28	25-49	\$39.22	50-99	\$37.15	100+	\$35.50	 <table border="1"> <thead> <tr> <th colspan="2">PRICE</th> </tr> </thead> <tbody> <tr> <td>1-24</td> <td>\$38.93</td> </tr> <tr> <td>25-49</td> <td>\$36.98</td> </tr> <tr> <td>50-99</td> <td>\$35.04</td> </tr> <tr> <td>100+</td> <td>\$33.48</td> </tr> </tbody> </table> <p>Low PIM NEW QD 4.3-10 Female to N Male VSWR 1.25:1 to 6 GHz Model No: <a href="#">PE91481</a></p>	PRICE		1-24	\$38.93	25-49	\$36.98	50-99	\$35.04	100+	\$33.48
	PRICE																																																						
1-24	\$56.45																																																						
25-49	\$53.63																																																						
50-99	\$50.81																																																						
100+	\$48.55																																																						
PRICE																																																							
1-24	\$84.23																																																						
25-49	\$80.02																																																						
50-99	\$75.81																																																						
100+	\$72.44																																																						
PRICE																																																							
1-24	\$34.63																																																						
25-49	\$32.90																																																						
50-99	\$31.17																																																						
100+	\$29.78																																																						
PRICE																																																							
1-24	\$41.28																																																						
25-49	\$39.22																																																						
50-99	\$37.15																																																						
100+	\$35.50																																																						
PRICE																																																							
1-24	\$38.93																																																						
25-49	\$36.98																																																						
50-99	\$35.04																																																						
100+	\$33.48																																																						
7	 <table border="1"> <thead> <tr> <th colspan="2">PRICE</th> </tr> </thead> <tbody> <tr> <td>1-24</td> <td>\$35.88</td> </tr> <tr> <td>25-49</td> <td>\$34.09</td> </tr> <tr> <td>50-99</td> <td>\$32.29</td> </tr> <tr> <td>100+</td> <td>\$30.86</td> </tr> </tbody> </table> <p>Low PIM NEW 4.3-10 Female to N Female VSWR 1.25:1 to 6 GHz Model No: <a href="#">PE91475</a></p>	PRICE		1-24	\$35.88	25-49	\$34.09	50-99	\$32.29	100+	\$30.86	 <table border="1"> <thead> <tr> <th colspan="2">PRICE</th> </tr> </thead> <tbody> <tr> <td>1-24</td> <td>\$38.72</td> </tr> <tr> <td>25-49</td> <td>\$36.78</td> </tr> <tr> <td>50-99</td> <td>\$34.85</td> </tr> <tr> <td>100+</td> <td>\$33.30</td> </tr> </tbody> </table> <p>Low PIM NEW QD 4.3-10 Female to N Female VSWR 1.25:1 to 6 GHz Model No: <a href="#">PE91482</a></p>	PRICE		1-24	\$38.72	25-49	\$36.78	50-99	\$34.85	100+	\$33.30	<div style="background-color: black; color: white; text-align: center; padding: 10px;"> <p><b>7/16 DIN</b> <i>In-Series</i></p> <p>→</p> </div>	 <table border="1"> <thead> <tr> <th colspan="2">PRICE</th> </tr> </thead> <tbody> <tr> <td>1-24</td> <td>\$85.18</td> </tr> <tr> <td>25-49</td> <td>\$80.92</td> </tr> <tr> <td>50-99</td> <td>\$76.66</td> </tr> <tr> <td>100+</td> <td>\$73.25</td> </tr> </tbody> </table> <p>7/16 DIN Male to 7/16 DIN Male VSWR 1.15:1 to 6 GHz Model No: <a href="#">PE91190</a></p>	PRICE		1-24	\$85.18	25-49	\$80.92	50-99	\$76.66	100+	\$73.25	 <table border="1"> <thead> <tr> <th colspan="2">PRICE</th> </tr> </thead> <tbody> <tr> <td>1-24</td> <td>\$88.90</td> </tr> <tr> <td>25-49</td> <td>\$84.46</td> </tr> <tr> <td>50-99</td> <td>\$80.01</td> </tr> <tr> <td>100+</td> <td>\$76.45</td> </tr> </tbody> </table> <p>7/16 DIN Male to 7/16 DIN Male VSWR 1.25:1 to 6 GHz Model No: <a href="#">PE91227</a></p>	PRICE		1-24	\$88.90	25-49	\$84.46	50-99	\$80.01	100+	\$76.45										
	PRICE																																																						
1-24	\$35.88																																																						
25-49	\$34.09																																																						
50-99	\$32.29																																																						
100+	\$30.86																																																						
PRICE																																																							
1-24	\$38.72																																																						
25-49	\$36.78																																																						
50-99	\$34.85																																																						
100+	\$33.30																																																						
PRICE																																																							
1-24	\$85.18																																																						
25-49	\$80.92																																																						
50-99	\$76.66																																																						
100+	\$73.25																																																						
PRICE																																																							
1-24	\$88.90																																																						
25-49	\$84.46																																																						
50-99	\$80.01																																																						
100+	\$76.45																																																						



# ADAPTERS

See Adapter Locator on Pages 8-13

See Page 369 for Mounting Holes

	A	B	C	D	E																																													
<b>1</b>	 <table border="1"> <thead> <tr><th>PRICE</th></tr> </thead> <tbody> <tr><td>1-9</td><td>\$114.26</td></tr> <tr><td>10-24</td><td>\$108.55</td></tr> <tr><td>25-49</td><td>\$102.83</td></tr> <tr><td>50+</td><td>\$98.26</td></tr> </tbody> </table> <p>Low PIM 7/16 DIN Male to 7/16 DIN Male Max. Freq. 8 GHz Model No: <a href="#">PE91039</a></p>	PRICE	1-9	\$114.26	10-24	\$108.55	25-49	\$102.83	50+	\$98.26	 <table border="1"> <thead> <tr><th>PRICE</th></tr> </thead> <tbody> <tr><td>1-24</td><td>\$65.52</td></tr> <tr><td>25-49</td><td>\$62.24</td></tr> <tr><td>50-99</td><td>\$58.97</td></tr> <tr><td>100+</td><td>\$56.35</td></tr> </tbody> </table> <p>7/16 DIN Male to 7/16 DIN Female VSWR 1.15:1 to 6 GHz Model No: <a href="#">PE91191</a></p>	PRICE	1-24	\$65.52	25-49	\$62.24	50-99	\$58.97	100+	\$56.35	 <table border="1"> <thead> <tr><th>PRICE</th></tr> </thead> <tbody> <tr><td>1-24</td><td>\$67.57</td></tr> <tr><td>25-49</td><td>\$64.19</td></tr> <tr><td>50-99</td><td>\$60.81</td></tr> <tr><td>100+</td><td>\$58.11</td></tr> </tbody> </table> <p>7/16 DIN Male to 7/16 DIN Female VSWR 1.25:1 to 6 GHz Model No: <a href="#">PE91228</a></p>	PRICE	1-24	\$67.57	25-49	\$64.19	50-99	\$60.81	100+	\$58.11	 <table border="1"> <thead> <tr><th>PRICE</th></tr> </thead> <tbody> <tr><td>1-9</td><td>\$128.97</td></tr> <tr><td>10-24</td><td>\$122.52</td></tr> <tr><td>25-49</td><td>\$116.07</td></tr> <tr><td>50+</td><td>\$110.91</td></tr> </tbody> </table> <p>7/16 DIN Male to 7/16 DIN Female VSWR 1.35:1 to 7.5 GHz Model No: <a href="#">PE91027</a></p>	PRICE	1-9	\$128.97	10-24	\$122.52	25-49	\$116.07	50+	\$110.91	 <table border="1"> <thead> <tr><th>PRICE</th></tr> </thead> <tbody> <tr><td>1-9</td><td>\$108.84</td></tr> <tr><td>10-24</td><td>\$103.40</td></tr> <tr><td>25-49</td><td>\$97.96</td></tr> <tr><td>50+</td><td>\$93.60</td></tr> </tbody> </table> <p>Low PIM 7/16 DIN Male to 7/16 DIN Female Max. Freq. 8 GHz Model No: <a href="#">PE91028</a></p>	PRICE	1-9	\$108.84	10-24	\$103.40	25-49	\$97.96	50+	\$93.60
PRICE																																																		
1-9	\$114.26																																																	
10-24	\$108.55																																																	
25-49	\$102.83																																																	
50+	\$98.26																																																	
PRICE																																																		
1-24	\$65.52																																																	
25-49	\$62.24																																																	
50-99	\$58.97																																																	
100+	\$56.35																																																	
PRICE																																																		
1-24	\$67.57																																																	
25-49	\$64.19																																																	
50-99	\$60.81																																																	
100+	\$58.11																																																	
PRICE																																																		
1-9	\$128.97																																																	
10-24	\$122.52																																																	
25-49	\$116.07																																																	
50+	\$110.91																																																	
PRICE																																																		
1-9	\$108.84																																																	
10-24	\$103.40																																																	
25-49	\$97.96																																																	
50+	\$93.60																																																	
<b>2</b>	 <table border="1"> <thead> <tr><th>PRICE</th></tr> </thead> <tbody> <tr><td>1-24</td><td>\$78.60</td></tr> <tr><td>25-49</td><td>\$74.67</td></tr> <tr><td>50-99</td><td>\$70.74</td></tr> <tr><td>100+</td><td>\$67.60</td></tr> </tbody> </table> <p>7/16 DIN Male to 7/16 DIN Female Right Angle VSWR 1.25:1 to 6 GHz Model No: <a href="#">PE91117</a></p>	PRICE	1-24	\$78.60	25-49	\$74.67	50-99	\$70.74	100+	\$67.60	 <table border="1"> <thead> <tr><th>PRICE</th></tr> </thead> <tbody> <tr><td>1-9</td><td>\$260.35</td></tr> <tr><td>10-24</td><td>\$247.33</td></tr> <tr><td>25-49</td><td>\$234.32</td></tr> <tr><td>50+</td><td>\$223.90</td></tr> </tbody> </table> <p>7/16 DIN Female to 7/16 DIN Male Tee Model No: <a href="#">PE9557</a></p>	PRICE	1-9	\$260.35	10-24	\$247.33	25-49	\$234.32	50+	\$223.90	 <table border="1"> <thead> <tr><th>PRICE</th></tr> </thead> <tbody> <tr><td>1-24</td><td>\$72.79</td></tr> <tr><td>25-49</td><td>\$69.15</td></tr> <tr><td>50-99</td><td>\$65.51</td></tr> <tr><td>100+</td><td>\$62.60</td></tr> </tbody> </table> <p>7/16 DIN Female to 7/16 DIN Female VSWR 1.15:1 to 6 GHz Model No: <a href="#">PE91192</a></p>	PRICE	1-24	\$72.79	25-49	\$69.15	50-99	\$65.51	100+	\$62.60	 <table border="1"> <thead> <tr><th>PRICE</th></tr> </thead> <tbody> <tr><td>1-24</td><td>\$59.59</td></tr> <tr><td>25-49</td><td>\$56.61</td></tr> <tr><td>50-99</td><td>\$53.63</td></tr> <tr><td>100+</td><td>\$51.25</td></tr> </tbody> </table> <p>7/16 DIN Female to 7/16 DIN Female VSWR 1.25:1 to 6 GHz Model No: <a href="#">PE91229</a></p>	PRICE	1-24	\$59.59	25-49	\$56.61	50-99	\$53.63	100+	\$51.25	 <table border="1"> <thead> <tr><th>PRICE</th></tr> </thead> <tbody> <tr><td>1-9</td><td>\$108.84</td></tr> <tr><td>10-24</td><td>\$103.40</td></tr> <tr><td>25-49</td><td>\$97.96</td></tr> <tr><td>50+</td><td>\$93.60</td></tr> </tbody> </table> <p>Low PIM 7/16 DIN Female to 7/16 DIN Female Max. Freq. 8 GHz Model No: <a href="#">PE91029</a></p>	PRICE	1-9	\$108.84	10-24	\$103.40	25-49	\$97.96	50+	\$93.60
PRICE																																																		
1-24	\$78.60																																																	
25-49	\$74.67																																																	
50-99	\$70.74																																																	
100+	\$67.60																																																	
PRICE																																																		
1-9	\$260.35																																																	
10-24	\$247.33																																																	
25-49	\$234.32																																																	
50+	\$223.90																																																	
PRICE																																																		
1-24	\$72.79																																																	
25-49	\$69.15																																																	
50-99	\$65.51																																																	
100+	\$62.60																																																	
PRICE																																																		
1-24	\$59.59																																																	
25-49	\$56.61																																																	
50-99	\$53.63																																																	
100+	\$51.25																																																	
PRICE																																																		
1-9	\$108.84																																																	
10-24	\$103.40																																																	
25-49	\$97.96																																																	
50+	\$93.60																																																	
<b>3</b>	 <table border="1"> <thead> <tr><th>PRICE</th></tr> </thead> <tbody> <tr><td>1-9</td><td>\$121.40</td></tr> <tr><td>10-24</td><td>\$115.33</td></tr> <tr><td>25-49</td><td>\$109.26</td></tr> <tr><td>50+</td><td>\$104.40</td></tr> </tbody> </table> <p>7/16 DIN Female to 7/16 DIN Female Model No: <a href="#">PE9409</a></p>	PRICE	1-9	\$121.40	10-24	\$115.33	25-49	\$109.26	50+	\$104.40	 <table border="1"> <thead> <tr><th>PRICE</th></tr> </thead> <tbody> <tr><td>1-9</td><td>\$272.54</td></tr> <tr><td>10-24</td><td>\$258.91</td></tr> <tr><td>25-49</td><td>\$245.29</td></tr> <tr><td>50+</td><td>\$234.38</td></tr> </tbody> </table> <p>7/16 DIN Female to 7/16 DIN Female Tee Model No: <a href="#">PE9556</a></p>	PRICE	1-9	\$272.54	10-24	\$258.91	25-49	\$245.29	50+	\$234.38	 <table border="1"> <thead> <tr><th>PRICE</th></tr> </thead> <tbody> <tr><td>1-9</td><td>\$142.97</td></tr> <tr><td>10-24</td><td>\$135.82</td></tr> <tr><td>25-49</td><td>\$128.67</td></tr> <tr><td>50+</td><td>\$122.95</td></tr> </tbody> </table> <p>Low PIM 7/16 DIN Female to 7/16 DIN Female Bulkhead Max. Freq. 8 GHz Model No: <a href="#">PE91038</a></p>	PRICE	1-9	\$142.97	10-24	\$135.82	25-49	\$128.67	50+	\$122.95	 <table border="1"> <thead> <tr><th>PRICE</th></tr> </thead> <tbody> <tr><td>1-9</td><td>\$269.67</td></tr> <tr><td>10-24</td><td>\$256.19</td></tr> <tr><td>25-49</td><td>\$242.70</td></tr> <tr><td>50+</td><td>\$231.92</td></tr> </tbody> </table> <p>7/16 DIN Female to 7/16 DIN Female Bulkhead Model No: <a href="#">PE9414</a></p>	PRICE	1-9	\$269.67	10-24	\$256.19	25-49	\$242.70	50+	\$231.92	 <table border="1"> <thead> <tr><th>PRICE</th></tr> </thead> <tbody> <tr><td>1-24</td><td>\$100.74</td></tr> <tr><td>25-49</td><td>\$95.70</td></tr> <tr><td>50-99</td><td>\$90.67</td></tr> <tr><td>100+</td><td>\$86.64</td></tr> </tbody> </table> <p>7/16 DIN Female to 7/16 DIN Female Bulkhead VSWR 1.25:1 to 6 GHz Model No: <a href="#">PE91193</a></p>	PRICE	1-24	\$100.74	25-49	\$95.70	50-99	\$90.67	100+	\$86.64
PRICE																																																		
1-9	\$121.40																																																	
10-24	\$115.33																																																	
25-49	\$109.26																																																	
50+	\$104.40																																																	
PRICE																																																		
1-9	\$272.54																																																	
10-24	\$258.91																																																	
25-49	\$245.29																																																	
50+	\$234.38																																																	
PRICE																																																		
1-9	\$142.97																																																	
10-24	\$135.82																																																	
25-49	\$128.67																																																	
50+	\$122.95																																																	
PRICE																																																		
1-9	\$269.67																																																	
10-24	\$256.19																																																	
25-49	\$242.70																																																	
50+	\$231.92																																																	
PRICE																																																		
1-24	\$100.74																																																	
25-49	\$95.70																																																	
50-99	\$90.67																																																	
100+	\$86.64																																																	
<b>4</b>	 <table border="1"> <thead> <tr><th>PRICE</th></tr> </thead> <tbody> <tr><td>1-24</td><td>\$93.13</td></tr> <tr><td>25-49</td><td>\$88.47</td></tr> <tr><td>50-99</td><td>\$83.82</td></tr> <tr><td>100+</td><td>\$80.09</td></tr> </tbody> </table> <p>7/16 DIN Female to 7/16 DIN Female Bulkhead VSWR 1.25:1 to 6 GHz Model No: <a href="#">PE91230</a></p>	PRICE	1-24	\$93.13	25-49	\$88.47	50-99	\$83.82	100+	\$80.09	<p><b>7/16 DIN Between Series</b></p> 		 <table border="1"> <thead> <tr><th>PRICE</th></tr> </thead> <tbody> <tr><td>1-24</td><td>\$68.08</td></tr> <tr><td>25-49</td><td>\$64.68</td></tr> <tr><td>50-99</td><td>\$61.27</td></tr> <tr><td>100+</td><td>\$58.55</td></tr> </tbody> </table> <p>7/16 DIN Male to 4.1/9.5 Mini DIN Male VSWR 1.25:1 to 6 GHz Model No: <a href="#">PE91206</a></p>	PRICE	1-24	\$68.08	25-49	\$64.68	50-99	\$61.27	100+	\$58.55	 <table border="1"> <thead> <tr><th>PRICE</th></tr> </thead> <tbody> <tr><td>1-24</td><td>\$38.62</td></tr> <tr><td>25-49</td><td>\$36.69</td></tr> <tr><td>50-99</td><td>\$34.76</td></tr> <tr><td>100+</td><td>\$33.21</td></tr> </tbody> </table> <p>7/16 DIN Male to 4.1/9.5 Mini DIN Male VSWR 1.3:1 to 6 GHz Model No: <a href="#">PE91243</a></p>	PRICE	1-24	\$38.62	25-49	\$36.69	50-99	\$34.76	100+	\$33.21	 <table border="1"> <thead> <tr><th>PRICE</th></tr> </thead> <tbody> <tr><td>1-24</td><td>\$77.31</td></tr> <tr><td>25-49</td><td>\$73.44</td></tr> <tr><td>50-99</td><td>\$69.58</td></tr> <tr><td>100+</td><td>\$66.49</td></tr> </tbody> </table> <p>Low PIM 7/16 DIN Male to 4.1/9.5 Mini DIN Male VSWR 1.25:1 to 6 GHz Model No: <a href="#">PE91088</a></p>	PRICE	1-24	\$77.31	25-49	\$73.44	50-99	\$69.58	100+	\$66.49								
PRICE																																																		
1-24	\$93.13																																																	
25-49	\$88.47																																																	
50-99	\$83.82																																																	
100+	\$80.09																																																	
PRICE																																																		
1-24	\$68.08																																																	
25-49	\$64.68																																																	
50-99	\$61.27																																																	
100+	\$58.55																																																	
PRICE																																																		
1-24	\$38.62																																																	
25-49	\$36.69																																																	
50-99	\$34.76																																																	
100+	\$33.21																																																	
PRICE																																																		
1-24	\$77.31																																																	
25-49	\$73.44																																																	
50-99	\$69.58																																																	
100+	\$66.49																																																	
<b>5</b>	 <table border="1"> <thead> <tr><th>PRICE</th></tr> </thead> <tbody> <tr><td>1-24</td><td>\$59.56</td></tr> <tr><td>25-49</td><td>\$56.58</td></tr> <tr><td>50-99</td><td>\$53.60</td></tr> <tr><td>100+</td><td>\$51.22</td></tr> </tbody> </table> <p>7/16 DIN Male to 4.1/9.5 Mini DIN Female VSWR 1.25:1 to 6 GHz Model No: <a href="#">PE91207</a></p>	PRICE	1-24	\$59.56	25-49	\$56.58	50-99	\$53.60	100+	\$51.22	 <table border="1"> <thead> <tr><th>PRICE</th></tr> </thead> <tbody> <tr><td>1-24</td><td>\$35.80</td></tr> <tr><td>25-49</td><td>\$34.01</td></tr> <tr><td>50-99</td><td>\$32.22</td></tr> <tr><td>100+</td><td>\$30.79</td></tr> </tbody> </table> <p>7/16 DIN Male to 4.1/9.5 Mini DIN Female VSWR 1.25:1 to 6 GHz Model No: <a href="#">PE91244</a></p>	PRICE	1-24	\$35.80	25-49	\$34.01	50-99	\$32.22	100+	\$30.79	 <table border="1"> <thead> <tr><th>PRICE</th></tr> </thead> <tbody> <tr><td>1-24</td><td>\$83.50</td></tr> <tr><td>25-49</td><td>\$79.33</td></tr> <tr><td>50-99</td><td>\$75.15</td></tr> <tr><td>100+</td><td>\$71.81</td></tr> </tbody> </table> <p>Low PIM 7/16 DIN Male to 4.1/9.5 Mini DIN Female VSWR 1.25:1 to 6 GHz Model No: <a href="#">PE91089</a></p>	PRICE	1-24	\$83.50	25-49	\$79.33	50-99	\$75.15	100+	\$71.81	 <table border="1"> <thead> <tr><th>PRICE</th></tr> </thead> <tbody> <tr><td>1-24</td><td>\$36.65</td></tr> <tr><td>25-49</td><td>\$34.82</td></tr> <tr><td>50-99</td><td>\$32.99</td></tr> <tr><td>100+</td><td>\$31.52</td></tr> </tbody> </table> <p>Low PIM NEW 7/16 DIN Male to 4.3-10 Male VSWR 1.25:1 to 6 GHz Model No: <a href="#">PE91468</a></p>	PRICE	1-24	\$36.65	25-49	\$34.82	50-99	\$32.99	100+	\$31.52	 <table border="1"> <thead> <tr><th>PRICE</th></tr> </thead> <tbody> <tr><td>1-24</td><td>\$39.69</td></tr> <tr><td>25-49</td><td>\$37.71</td></tr> <tr><td>50-99</td><td>\$35.72</td></tr> <tr><td>100+</td><td>\$34.13</td></tr> </tbody> </table> <p>Low PIM NEW 7/16 DIN Male to 4.3-10 Female VSWR 1.25:1 to 6 GHz Model No: <a href="#">PE91469</a></p>	PRICE	1-24	\$39.69	25-49	\$37.71	50-99	\$35.72	100+	\$34.13
PRICE																																																		
1-24	\$59.56																																																	
25-49	\$56.58																																																	
50-99	\$53.60																																																	
100+	\$51.22																																																	
PRICE																																																		
1-24	\$35.80																																																	
25-49	\$34.01																																																	
50-99	\$32.22																																																	
100+	\$30.79																																																	
PRICE																																																		
1-24	\$83.50																																																	
25-49	\$79.33																																																	
50-99	\$75.15																																																	
100+	\$71.81																																																	
PRICE																																																		
1-24	\$36.65																																																	
25-49	\$34.82																																																	
50-99	\$32.99																																																	
100+	\$31.52																																																	
PRICE																																																		
1-24	\$39.69																																																	
25-49	\$37.71																																																	
50-99	\$35.72																																																	
100+	\$34.13																																																	
<b>6</b>	 <table border="1"> <thead> <tr><th>PRICE</th></tr> </thead> <tbody> <tr><td>1-24</td><td>\$69.15</td></tr> <tr><td>25-49</td><td>\$65.69</td></tr> <tr><td>50-99</td><td>\$62.24</td></tr> <tr><td>100+</td><td>\$59.47</td></tr> </tbody> </table> <p>Low PIM NEW 7/16 DIN Male to 4.3-10 Female VSWR 1.08:1 to 6 GHz Model No: <a href="#">PE91390</a></p>	PRICE	1-24	\$69.15	25-49	\$65.69	50-99	\$62.24	100+	\$59.47	 <table border="1"> <thead> <tr><th>PRICE</th></tr> </thead> <tbody> <tr><td>1-9</td><td>\$160.81</td></tr> <tr><td>10-24</td><td>\$152.77</td></tr> <tr><td>25-49</td><td>\$144.73</td></tr> <tr><td>50+</td><td>\$138.30</td></tr> </tbody> </table> <p>7/16 DIN Male to HN Female Model No: <a href="#">PE9558</a></p>	PRICE	1-9	\$160.81	10-24	\$152.77	25-49	\$144.73	50+	\$138.30	 <table border="1"> <thead> <tr><th>PRICE</th></tr> </thead> <tbody> <tr><td>1-24</td><td>\$65.21</td></tr> <tr><td>25-49</td><td>\$61.95</td></tr> <tr><td>50-99</td><td>\$58.69</td></tr> <tr><td>100+</td><td>\$56.08</td></tr> </tbody> </table> <p>7/16 DIN Male to N Male VSWR 1.15:1 to 6 GHz Model No: <a href="#">PE91211</a></p>	PRICE	1-24	\$65.21	25-49	\$61.95	50-99	\$58.69	100+	\$56.08	 <table border="1"> <thead> <tr><th>PRICE</th></tr> </thead> <tbody> <tr><td>1-24</td><td>\$81.69</td></tr> <tr><td>25-49</td><td>\$77.61</td></tr> <tr><td>50-99</td><td>\$73.52</td></tr> <tr><td>100+</td><td>\$70.25</td></tr> </tbody> </table> <p>7/16 DIN Male to N Male VSWR 1.25:1 to 6 GHz Model No: <a href="#">PE91248</a></p>	PRICE	1-24	\$81.69	25-49	\$77.61	50-99	\$73.52	100+	\$70.25	 <table border="1"> <thead> <tr><th>PRICE</th></tr> </thead> <tbody> <tr><td>1-24</td><td>\$64.02</td></tr> <tr><td>25-49</td><td>\$60.82</td></tr> <tr><td>50-99</td><td>\$57.62</td></tr> <tr><td>100+</td><td>\$55.06</td></tr> </tbody> </table> <p>7/16 DIN Male to N Female VSWR 1.15:1 to 6 GHz Model No: <a href="#">PE91212</a></p>	PRICE	1-24	\$64.02	25-49	\$60.82	50-99	\$57.62	100+	\$55.06
PRICE																																																		
1-24	\$69.15																																																	
25-49	\$65.69																																																	
50-99	\$62.24																																																	
100+	\$59.47																																																	
PRICE																																																		
1-9	\$160.81																																																	
10-24	\$152.77																																																	
25-49	\$144.73																																																	
50+	\$138.30																																																	
PRICE																																																		
1-24	\$65.21																																																	
25-49	\$61.95																																																	
50-99	\$58.69																																																	
100+	\$56.08																																																	
PRICE																																																		
1-24	\$81.69																																																	
25-49	\$77.61																																																	
50-99	\$73.52																																																	
100+	\$70.25																																																	
PRICE																																																		
1-24	\$64.02																																																	
25-49	\$60.82																																																	
50-99	\$57.62																																																	
100+	\$55.06																																																	
<b>7</b>	 <table border="1"> <thead> <tr><th>PRICE</th></tr> </thead> <tbody> <tr><td>1-24</td><td>\$47.40</td></tr> <tr><td>25-49</td><td>\$45.03</td></tr> <tr><td>50-99</td><td>\$42.66</td></tr> <tr><td>100+</td><td>\$40.76</td></tr> </tbody> </table> <p>7/16 DIN Male to N Female VSWR 1.25:1 to 6 GHz Model No: <a href="#">PE91249</a></p>	PRICE	1-24	\$47.40	25-49	\$45.03	50-99	\$42.66	100+	\$40.76	 <table border="1"> <thead> <tr><th>PRICE</th></tr> </thead> <tbody> <tr><td>1-9</td><td>\$182.18</td></tr> <tr><td>10-24</td><td>\$173.07</td></tr> <tr><td>25-49</td><td>\$163.96</td></tr> <tr><td>NEW 50+</td><td>\$156.67</td></tr> </tbody> </table> <p>7/16 DIN Male to SC Female VSWR 1.25:1 to 7.5 GHz Model No: <a href="#">PE91444</a></p>	PRICE	1-9	\$182.18	10-24	\$173.07	25-49	\$163.96	NEW 50+	\$156.67	 <table border="1"> <thead> <tr><th>PRICE</th></tr> </thead> <tbody> <tr><td>1-24</td><td>\$68.08</td></tr> <tr><td>25-49</td><td>\$64.68</td></tr> <tr><td>50-99</td><td>\$61.27</td></tr> <tr><td>100+</td><td>\$58.55</td></tr> </tbody> </table> <p>7/16 DIN Female to 4.1/9.5 Mini DIN Male VSWR 1.25:1 to 6 GHz Model No: <a href="#">PE91209</a></p>	PRICE	1-24	\$68.08	25-49	\$64.68	50-99	\$61.27	100+	\$58.55	 <table border="1"> <thead> <tr><th>PRICE</th></tr> </thead> <tbody> <tr><td>1-24</td><td>\$33.66</td></tr> <tr><td>25-49</td><td>\$31.98</td></tr> <tr><td>50-99</td><td>\$30.29</td></tr> <tr><td>100+</td><td>\$28.95</td></tr> </tbody> </table> <p>7/16 DIN Female to 4.1/9.5 Mini DIN Male VSWR 1.25:1 to 6 GHz Model No: <a href="#">PE91246</a></p>	PRICE	1-24	\$33.66	25-49	\$31.98	50-99	\$30.29	100+	\$28.95	 <table border="1"> <thead> <tr><th>PRICE</th></tr> </thead> <tbody> <tr><td>1-24</td><td>\$77.31</td></tr> <tr><td>25-49</td><td>\$73.44</td></tr> <tr><td>50-99</td><td>\$69.58</td></tr> <tr><td>100+</td><td>\$66.49</td></tr> </tbody> </table> <p>Low PIM 7/16 DIN Female to 4.1/9.5 Mini DIN Male VSWR 1.25:1 to 6 GHz Model No: <a href="#">PE91090</a></p>	PRICE	1-24	\$77.31	25-49	\$73.44	50-99	\$69.58	100+	\$66.49
PRICE																																																		
1-24	\$47.40																																																	
25-49	\$45.03																																																	
50-99	\$42.66																																																	
100+	\$40.76																																																	
PRICE																																																		
1-9	\$182.18																																																	
10-24	\$173.07																																																	
25-49	\$163.96																																																	
NEW 50+	\$156.67																																																	
PRICE																																																		
1-24	\$68.08																																																	
25-49	\$64.68																																																	
50-99	\$61.27																																																	
100+	\$58.55																																																	
PRICE																																																		
1-24	\$33.66																																																	
25-49	\$31.98																																																	
50-99	\$30.29																																																	
100+	\$28.95																																																	
PRICE																																																		
1-24	\$77.31																																																	
25-49	\$73.44																																																	
50-99	\$69.58																																																	
100+	\$66.49																																																	



Technical Support  
+1 (949) 261-1920



Same-Day Shipping,  
Even Custom Cable Assemblies

# ADAPTERS

See Adapter Locator on Pages 8-13

See Page 369 for Mounting Holes

Adapters

See Our Website For Current Pricing & Real-Time Stock Availability!

	A	B	C	D	E																																																		
1	 <table border="1"> <thead> <tr> <th colspan="2">PRICE</th> </tr> </thead> <tbody> <tr> <td>1-24</td> <td>\$61.88</td> </tr> <tr> <td>25-49</td> <td>\$58.79</td> </tr> <tr> <td>50-99</td> <td>\$55.69</td> </tr> <tr> <td>100+</td> <td>\$53.22</td> </tr> </tbody> </table> <p>7/16 DIN Female to 4.1/9.5 Mini DIN Female VSWR 1.25:1 to 6 GHz Model No: <a href="#">PE91208</a></p>	PRICE		1-24	\$61.88	25-49	\$58.79	50-99	\$55.69	100+	\$53.22	 <table border="1"> <thead> <tr> <th colspan="2">PRICE</th> </tr> </thead> <tbody> <tr> <td>1-24</td> <td>\$32.52</td> </tr> <tr> <td>25-49</td> <td>\$30.89</td> </tr> <tr> <td>50-99</td> <td>\$29.27</td> </tr> <tr> <td>100+</td> <td>\$27.97</td> </tr> </tbody> </table> <p>7/16 DIN Female to 4.1/9.5 Mini DIN Female VSWR 1.35:1 to 6 GHz Model No: <a href="#">PE91245</a></p>	PRICE		1-24	\$32.52	25-49	\$30.89	50-99	\$29.27	100+	\$27.97	 <table border="1"> <thead> <tr> <th colspan="2">PRICE</th> </tr> </thead> <tbody> <tr> <td>1-24</td> <td>\$77.31</td> </tr> <tr> <td>25-49</td> <td>\$73.44</td> </tr> <tr> <td>50-99</td> <td>\$69.58</td> </tr> <tr> <td>100+</td> <td>\$66.49</td> </tr> </tbody> </table> <p>Low PIM 7/16 DIN Female to 4.1/9.5 Mini DIN Female VSWR 1.25:1 to 6 GHz Model No: <a href="#">PE91091</a></p>	PRICE		1-24	\$77.31	25-49	\$73.44	50-99	\$69.58	100+	\$66.49	 <table border="1"> <thead> <tr> <th colspan="2">PRICE</th> </tr> </thead> <tbody> <tr> <td>1-24</td> <td>\$68.04</td> </tr> <tr> <td>25-49</td> <td>\$64.64</td> </tr> <tr> <td>50-99</td> <td>\$61.24</td> </tr> <tr> <td>100+</td> <td>\$58.51</td> </tr> </tbody> </table> <p>7/16 DIN Female to 4.1/9.5 Mini DIN Female Bulkhead VSWR 1.25:1 to 6 GHz Model No: <a href="#">PE91210</a></p>	PRICE		1-24	\$68.04	25-49	\$64.64	50-99	\$61.24	100+	\$58.51	 <table border="1"> <thead> <tr> <th colspan="2">PRICE</th> </tr> </thead> <tbody> <tr> <td>1-24</td> <td>\$34.73</td> </tr> <tr> <td>25-49</td> <td>\$32.99</td> </tr> <tr> <td>50-99</td> <td>\$31.26</td> </tr> <tr> <td>100+</td> <td>\$29.87</td> </tr> </tbody> </table> <p>7/16 DIN Female to 4.1/9.5 Mini DIN Female Bulkhead VSWR 1.3:1 to 6 GHz Model No: <a href="#">PE91247</a></p>	PRICE		1-24	\$34.73	25-49	\$32.99	50-99	\$31.26	100+	\$29.87
PRICE																																																							
1-24	\$61.88																																																						
25-49	\$58.79																																																						
50-99	\$55.69																																																						
100+	\$53.22																																																						
PRICE																																																							
1-24	\$32.52																																																						
25-49	\$30.89																																																						
50-99	\$29.27																																																						
100+	\$27.97																																																						
PRICE																																																							
1-24	\$77.31																																																						
25-49	\$73.44																																																						
50-99	\$69.58																																																						
100+	\$66.49																																																						
PRICE																																																							
1-24	\$68.04																																																						
25-49	\$64.64																																																						
50-99	\$61.24																																																						
100+	\$58.51																																																						
PRICE																																																							
1-24	\$34.73																																																						
25-49	\$32.99																																																						
50-99	\$31.26																																																						
100+	\$29.87																																																						
2	 <table border="1"> <thead> <tr> <th colspan="2">PRICE</th> </tr> </thead> <tbody> <tr> <td>1-24</td> <td>\$38.93</td> </tr> <tr> <td>25-49</td> <td>\$36.98</td> </tr> <tr> <td>50-99</td> <td>\$35.04</td> </tr> <tr> <td>100+</td> <td>\$33.48</td> </tr> </tbody> </table> <p>Low PIM NEW 7/16 DIN Female to 4.3-10 Male VSWR 1.2:1 to 6 GHz Model No: <a href="#">PE91470</a></p>	PRICE		1-24	\$38.93	25-49	\$36.98	50-99	\$35.04	100+	\$33.48	 <table border="1"> <thead> <tr> <th colspan="2">PRICE</th> </tr> </thead> <tbody> <tr> <td>1-24</td> <td>\$55.13</td> </tr> <tr> <td>25-49</td> <td>\$52.37</td> </tr> <tr> <td>50-99</td> <td>\$49.62</td> </tr> <tr> <td>100+</td> <td>\$47.41</td> </tr> </tbody> </table> <p>Low PIM NEW 7/16 DIN Female to QD 4.3-10 Male VSWR 1.2:1 to 6 GHz Model No: <a href="#">PE91472</a></p>	PRICE		1-24	\$55.13	25-49	\$52.37	50-99	\$49.62	100+	\$47.41	 <table border="1"> <thead> <tr> <th colspan="2">PRICE</th> </tr> </thead> <tbody> <tr> <td>1-9</td> <td>\$112.70</td> </tr> <tr> <td>10-24</td> <td>\$107.07</td> </tr> <tr> <td>25-49</td> <td>\$101.43</td> </tr> <tr> <td>50+</td> <td>\$96.92</td> </tr> </tbody> </table> <p>Low PIM NEW 7/16 DIN Female to 4.3-10 Male VSWR 1.08:1 to 6 GHz Model No: <a href="#">PE91391</a></p>	PRICE		1-9	\$112.70	10-24	\$107.07	25-49	\$101.43	50+	\$96.92	 <table border="1"> <thead> <tr> <th colspan="2">PRICE</th> </tr> </thead> <tbody> <tr> <td>1-24</td> <td>\$39.69</td> </tr> <tr> <td>25-49</td> <td>\$37.71</td> </tr> <tr> <td>50-99</td> <td>\$35.72</td> </tr> <tr> <td>100+</td> <td>\$34.13</td> </tr> </tbody> </table> <p>Low PIM NEW 7/16 DIN Female to 4.3-10 Female VSWR 1.25:1 to 6 GHz Model No: <a href="#">PE91471</a></p>	PRICE		1-24	\$39.69	25-49	\$37.71	50-99	\$35.72	100+	\$34.13	 <table border="1"> <thead> <tr> <th colspan="2">PRICE</th> </tr> </thead> <tbody> <tr> <td>1-24</td> <td>\$40.53</td> </tr> <tr> <td>25-49</td> <td>\$38.50</td> </tr> <tr> <td>50-99</td> <td>\$36.48</td> </tr> <tr> <td>100+</td> <td>\$34.86</td> </tr> </tbody> </table> <p>Low PIM NEW 7/16 DIN Female to QD 4.3-10 Female VSWR 1.2:1 to 6 GHz Model No: <a href="#">PE91473</a></p>	PRICE		1-24	\$40.53	25-49	\$38.50	50-99	\$36.48	100+	\$34.86
PRICE																																																							
1-24	\$38.93																																																						
25-49	\$36.98																																																						
50-99	\$35.04																																																						
100+	\$33.48																																																						
PRICE																																																							
1-24	\$55.13																																																						
25-49	\$52.37																																																						
50-99	\$49.62																																																						
100+	\$47.41																																																						
PRICE																																																							
1-9	\$112.70																																																						
10-24	\$107.07																																																						
25-49	\$101.43																																																						
50+	\$96.92																																																						
PRICE																																																							
1-24	\$39.69																																																						
25-49	\$37.71																																																						
50-99	\$35.72																																																						
100+	\$34.13																																																						
PRICE																																																							
1-24	\$40.53																																																						
25-49	\$38.50																																																						
50-99	\$36.48																																																						
100+	\$34.86																																																						
3	 <table border="1"> <thead> <tr> <th colspan="2">PRICE</th> </tr> </thead> <tbody> <tr> <td>1-9</td> <td>\$162.12</td> </tr> <tr> <td>10-24</td> <td>\$154.01</td> </tr> <tr> <td>25-49</td> <td>\$145.91</td> </tr> <tr> <td>50+</td> <td>\$139.42</td> </tr> </tbody> </table> <p>7/16 DIN Female to HN Male Model No: <a href="#">PE9559</a></p>	PRICE		1-9	\$162.12	10-24	\$154.01	25-49	\$145.91	50+	\$139.42	 <table border="1"> <thead> <tr> <th colspan="2">PRICE</th> </tr> </thead> <tbody> <tr> <td>1-24</td> <td>\$65.21</td> </tr> <tr> <td>25-49</td> <td>\$61.95</td> </tr> <tr> <td>50-99</td> <td>\$58.69</td> </tr> <tr> <td>100+</td> <td>\$56.08</td> </tr> </tbody> </table> <p>7/16 DIN Female to N Male VSWR 1.25:1 to 6 GHz Model No: <a href="#">PE91214</a></p>	PRICE		1-24	\$65.21	25-49	\$61.95	50-99	\$58.69	100+	\$56.08	 <table border="1"> <thead> <tr> <th colspan="2">PRICE</th> </tr> </thead> <tbody> <tr> <td>1-24</td> <td>\$48.04</td> </tr> <tr> <td>25-49</td> <td>\$45.64</td> </tr> <tr> <td>50-99</td> <td>\$43.24</td> </tr> <tr> <td>100+</td> <td>\$41.31</td> </tr> </tbody> </table> <p>7/16 DIN Female to N Male VSWR 1.25:1 to 6 GHz Model No: <a href="#">PE91251</a></p>	PRICE		1-24	\$48.04	25-49	\$45.64	50-99	\$43.24	100+	\$41.31	 <table border="1"> <thead> <tr> <th colspan="2">PRICE</th> </tr> </thead> <tbody> <tr> <td>1-24</td> <td>\$65.21</td> </tr> <tr> <td>25-49</td> <td>\$61.95</td> </tr> <tr> <td>50-99</td> <td>\$58.69</td> </tr> <tr> <td>100+</td> <td>\$56.08</td> </tr> </tbody> </table> <p>7/16 DIN Female to N Female VSWR 1.15:1 to 6 GHz Model No: <a href="#">PE91213</a></p>	PRICE		1-24	\$65.21	25-49	\$61.95	50-99	\$58.69	100+	\$56.08	 <table border="1"> <thead> <tr> <th colspan="2">PRICE</th> </tr> </thead> <tbody> <tr> <td>1-24</td> <td>\$49.26</td> </tr> <tr> <td>25-49</td> <td>\$46.80</td> </tr> <tr> <td>50-99</td> <td>\$44.33</td> </tr> <tr> <td>100+</td> <td>\$42.36</td> </tr> </tbody> </table> <p>7/16 DIN Female to N Female VSWR 1.25:1 to 6 GHz Model No: <a href="#">PE91250</a></p>	PRICE		1-24	\$49.26	25-49	\$46.80	50-99	\$44.33	100+	\$42.36
PRICE																																																							
1-9	\$162.12																																																						
10-24	\$154.01																																																						
25-49	\$145.91																																																						
50+	\$139.42																																																						
PRICE																																																							
1-24	\$65.21																																																						
25-49	\$61.95																																																						
50-99	\$58.69																																																						
100+	\$56.08																																																						
PRICE																																																							
1-24	\$48.04																																																						
25-49	\$45.64																																																						
50-99	\$43.24																																																						
100+	\$41.31																																																						
PRICE																																																							
1-24	\$65.21																																																						
25-49	\$61.95																																																						
50-99	\$58.69																																																						
100+	\$56.08																																																						
PRICE																																																							
1-24	\$49.26																																																						
25-49	\$46.80																																																						
50-99	\$44.33																																																						
100+	\$42.36																																																						
4	 <table border="1"> <thead> <tr> <th colspan="2">PRICE</th> </tr> </thead> <tbody> <tr> <td>1-24</td> <td>\$84.14</td> </tr> <tr> <td>25-49</td> <td>\$79.93</td> </tr> <tr> <td>50-99</td> <td>\$75.73</td> </tr> <tr> <td>100+</td> <td>\$72.36</td> </tr> </tbody> </table> <p>7/16 DIN Female to N Female Bulkhead VSWR 1.15:1 to 6 GHz Model No: <a href="#">PE91215</a></p>	PRICE		1-24	\$84.14	25-49	\$79.93	50-99	\$75.73	100+	\$72.36	 <table border="1"> <thead> <tr> <th colspan="2">PRICE</th> </tr> </thead> <tbody> <tr> <td>1-24</td> <td>\$44.42</td> </tr> <tr> <td>25-49</td> <td>\$42.20</td> </tr> <tr> <td>50-99</td> <td>\$39.98</td> </tr> <tr> <td>100+</td> <td>\$38.20</td> </tr> </tbody> </table> <p>7/16 DIN Female to N Female Bulkhead VSWR 1.25:1 to 6 GHz Model No: <a href="#">PE91252</a></p>	PRICE		1-24	\$44.42	25-49	\$42.20	50-99	\$39.98	100+	\$38.20	<p>10-32 In-Series</p> <p>→</p>		 <table border="1"> <thead> <tr> <th colspan="2">PRICE</th> </tr> </thead> <tbody> <tr> <td>1-24</td> <td>\$49.94</td> </tr> <tr> <td>25-49</td> <td>\$47.44</td> </tr> <tr> <td>50-99</td> <td>\$44.95</td> </tr> <tr> <td>100+</td> <td>\$42.95</td> </tr> </tbody> </table> <p>10-32 Female to 10-32 Female Model No: <a href="#">PE9756</a></p>	PRICE		1-24	\$49.94	25-49	\$47.44	50-99	\$44.95	100+	\$42.95	 <table border="1"> <thead> <tr> <th colspan="2">PRICE</th> </tr> </thead> <tbody> <tr> <td>1-24</td> <td>\$65.70</td> </tr> <tr> <td>25-49</td> <td>\$62.42</td> </tr> <tr> <td>50-99</td> <td>\$59.13</td> </tr> <tr> <td>100+</td> <td>\$56.50</td> </tr> </tbody> </table> <p>10-32 Female to 10-32 Female Bulkhead Model No: <a href="#">PE9757</a></p>	PRICE		1-24	\$65.70	25-49	\$62.42	50-99	\$59.13	100+	\$56.50									
PRICE																																																							
1-24	\$84.14																																																						
25-49	\$79.93																																																						
50-99	\$75.73																																																						
100+	\$72.36																																																						
PRICE																																																							
1-24	\$44.42																																																						
25-49	\$42.20																																																						
50-99	\$39.98																																																						
100+	\$38.20																																																						
PRICE																																																							
1-24	\$49.94																																																						
25-49	\$47.44																																																						
50-99	\$44.95																																																						
100+	\$42.95																																																						
PRICE																																																							
1-24	\$65.70																																																						
25-49	\$62.42																																																						
50-99	\$59.13																																																						
100+	\$56.50																																																						
5	<p>10-32 Between Series</p> <p>→</p>		 <table border="1"> <thead> <tr> <th colspan="2">PRICE</th> </tr> </thead> <tbody> <tr> <td>1-24</td> <td>\$76.30</td> </tr> <tr> <td>25-49</td> <td>\$72.49</td> </tr> <tr> <td>50-99</td> <td>\$68.67</td> </tr> <tr> <td>100+</td> <td>\$65.62</td> </tr> </tbody> </table> <p>10-32 Male to BNC Female Model No: <a href="#">PE9753</a></p>	PRICE		1-24	\$76.30	25-49	\$72.49	50-99	\$68.67	100+	\$65.62	 <table border="1"> <thead> <tr> <th colspan="2">PRICE</th> </tr> </thead> <tbody> <tr> <td>1-24</td> <td>\$100.58</td> </tr> <tr> <td>25-49</td> <td>\$95.55</td> </tr> <tr> <td>50-99</td> <td>\$90.52</td> </tr> <tr> <td>100+</td> <td>\$86.50</td> </tr> </tbody> </table> <p>10-32 Male to BNC Female Bulkhead Model No: <a href="#">PE9755</a></p>	PRICE		1-24	\$100.58	25-49	\$95.55	50-99	\$90.52	100+	\$86.50	 <table border="1"> <thead> <tr> <th colspan="2">PRICE</th> </tr> </thead> <tbody> <tr> <td>1-24</td> <td>\$62.87</td> </tr> <tr> <td>25-49</td> <td>\$59.73</td> </tr> <tr> <td>50-99</td> <td>\$56.58</td> </tr> <tr> <td>100+</td> <td>\$54.07</td> </tr> </tbody> </table> <p>10-32 Female to BNC Male Model No: <a href="#">PE9750</a></p>	PRICE		1-24	\$62.87	25-49	\$59.73	50-99	\$56.58	100+	\$54.07																				
PRICE																																																							
1-24	\$76.30																																																						
25-49	\$72.49																																																						
50-99	\$68.67																																																						
100+	\$65.62																																																						
PRICE																																																							
1-24	\$100.58																																																						
25-49	\$95.55																																																						
50-99	\$90.52																																																						
100+	\$86.50																																																						
PRICE																																																							
1-24	\$62.87																																																						
25-49	\$59.73																																																						
50-99	\$56.58																																																						
100+	\$54.07																																																						
6	 <table border="1"> <thead> <tr> <th colspan="2">PRICE</th> </tr> </thead> <tbody> <tr> <td>1-24</td> <td>\$68.53</td> </tr> <tr> <td>25-49</td> <td>\$65.10</td> </tr> <tr> <td>50-99</td> <td>\$61.68</td> </tr> <tr> <td>100+</td> <td>\$58.94</td> </tr> </tbody> </table> <p>10-32 Female to BNC Female Model No: <a href="#">PE9752</a></p>	PRICE		1-24	\$68.53	25-49	\$65.10	50-99	\$61.68	100+	\$58.94	 <table border="1"> <thead> <tr> <th colspan="2">PRICE</th> </tr> </thead> <tbody> <tr> <td>1-24</td> <td>\$70.94</td> </tr> <tr> <td>25-49</td> <td>\$67.39</td> </tr> <tr> <td>50-99</td> <td>\$63.85</td> </tr> <tr> <td>100+</td> <td>\$61.01</td> </tr> </tbody> </table> <p>10-32 Female to BNC Female Bulkhead Model No: <a href="#">PE9754</a></p>	PRICE		1-24	\$70.94	25-49	\$67.39	50-99	\$63.85	100+	\$61.01	<p>BMA In-Series</p> <p>→</p>		 <table border="1"> <thead> <tr> <th colspan="2">PRICE</th> </tr> </thead> <tbody> <tr> <td>1-24</td> <td>\$54.27</td> </tr> <tr> <td>25-49</td> <td>\$51.56</td> </tr> <tr> <td>50-99</td> <td>\$48.84</td> </tr> <tr> <td>100+</td> <td>\$46.67</td> </tr> </tbody> </table> <p>Slide-On BMA Jack to Slide-On BMA Jack VSWR 1.2:1 to 22 GHz Model No: <a href="#">PE91395</a></p>	PRICE		1-24	\$54.27	25-49	\$51.56	50-99	\$48.84	100+	\$46.67	<p>BMA Between Series</p> <p>→</p>																			
PRICE																																																							
1-24	\$68.53																																																						
25-49	\$65.10																																																						
50-99	\$61.68																																																						
100+	\$58.94																																																						
PRICE																																																							
1-24	\$70.94																																																						
25-49	\$67.39																																																						
50-99	\$63.85																																																						
100+	\$61.01																																																						
PRICE																																																							
1-24	\$54.27																																																						
25-49	\$51.56																																																						
50-99	\$48.84																																																						
100+	\$46.67																																																						
7	 <table border="1"> <thead> <tr> <th colspan="2">PRICE</th> </tr> </thead> <tbody> <tr> <td>1-9</td> <td>\$108.79</td> </tr> <tr> <td>10-24</td> <td>\$103.35</td> </tr> <tr> <td>25-49</td> <td>\$97.91</td> </tr> <tr> <td>NEW 50+</td> <td>\$93.56</td> </tr> </tbody> </table> <p>Slide-On BMA Plug to SMA Male VSWR 1.15:1 to 18 GHz Model No: <a href="#">PE91396</a></p>	PRICE		1-9	\$108.79	10-24	\$103.35	25-49	\$97.91	NEW 50+	\$93.56	 <table border="1"> <thead> <tr> <th colspan="2">PRICE</th> </tr> </thead> <tbody> <tr> <td>1-24</td> <td>\$103.58</td> </tr> <tr> <td>25-49</td> <td>\$98.40</td> </tr> <tr> <td>50-99</td> <td>\$93.22</td> </tr> <tr> <td>NEW 100+</td> <td>\$89.08</td> </tr> </tbody> </table> <p>Slide-On BMA Plug to SMA Male Bulkhead VSWR 1.15:1 to 18 GHz Model No: <a href="#">PE91401</a></p>	PRICE		1-24	\$103.58	25-49	\$98.40	50-99	\$93.22	NEW 100+	\$89.08	 <table border="1"> <thead> <tr> <th colspan="2">PRICE</th> </tr> </thead> <tbody> <tr> <td>1-9</td> <td>\$106.36</td> </tr> <tr> <td>10-24</td> <td>\$101.04</td> </tr> <tr> <td>25-49</td> <td>\$95.72</td> </tr> <tr> <td>NEW 50+</td> <td>\$91.47</td> </tr> </tbody> </table> <p>Slide-On BMA Plug to SMA Female VSWR 1.15:1 to 18 GHz Model No: <a href="#">PE91398</a></p>	PRICE		1-9	\$106.36	10-24	\$101.04	25-49	\$95.72	NEW 50+	\$91.47	 <table border="1"> <thead> <tr> <th colspan="2">PRICE</th> </tr> </thead> <tbody> <tr> <td>1-9</td> <td>\$126.54</td> </tr> <tr> <td>10-24</td> <td>\$120.21</td> </tr> <tr> <td>25-49</td> <td>\$113.89</td> </tr> <tr> <td>NEW 50+</td> <td>\$108.82</td> </tr> </tbody> </table> <p>Slide-On BMA Plug to SMA Female Bulkhead VSWR 1.15:1 to 18 GHz Model No: <a href="#">PE91402</a></p>	PRICE		1-9	\$126.54	10-24	\$120.21	25-49	\$113.89	NEW 50+	\$108.82	 <table border="1"> <thead> <tr> <th colspan="2">PRICE</th> </tr> </thead> <tbody> <tr> <td>1-9</td> <td>\$130.98</td> </tr> <tr> <td>10-24</td> <td>\$124.43</td> </tr> <tr> <td>25-49</td> <td>\$117.88</td> </tr> <tr> <td>NEW 50+</td> <td>\$112.64</td> </tr> </tbody> </table> <p>Slide-On BMA Jack to SMA Male VSWR 1.25:1 to 18 GHz Model No: <a href="#">PE91397</a></p>	PRICE		1-9	\$130.98	10-24	\$124.43	25-49	\$117.88	NEW 50+	\$112.64
PRICE																																																							
1-9	\$108.79																																																						
10-24	\$103.35																																																						
25-49	\$97.91																																																						
NEW 50+	\$93.56																																																						
PRICE																																																							
1-24	\$103.58																																																						
25-49	\$98.40																																																						
50-99	\$93.22																																																						
NEW 100+	\$89.08																																																						
PRICE																																																							
1-9	\$106.36																																																						
10-24	\$101.04																																																						
25-49	\$95.72																																																						
NEW 50+	\$91.47																																																						
PRICE																																																							
1-9	\$126.54																																																						
10-24	\$120.21																																																						
25-49	\$113.89																																																						
NEW 50+	\$108.82																																																						
PRICE																																																							
1-9	\$130.98																																																						
10-24	\$124.43																																																						
25-49	\$117.88																																																						
NEW 50+	\$112.64																																																						

# ADAPTERS

See Adapter Locator on Pages 8-13

See Page 369 for Mounting Holes

	A	B	C	D	E																																													
1	 <table border="1"> <thead> <tr><th>PRICE</th></tr></thead> <tbody> <tr><td>1-9</td><td>\$154.33</td></tr> <tr><td>10-24</td><td>\$146.61</td></tr> <tr><td>25-49</td><td>\$138.90</td></tr> <tr><td>NEW 50+</td><td>\$132.72</td></tr> </tbody> </table> <p>Slide-On BMA Jack to SMA Female VSWR 1.25:1 to 18 GHz Model No: <a href="#">PE91400</a></p>	PRICE	1-9	\$154.33	10-24	\$146.61	25-49	\$138.90	NEW 50+	\$132.72	 <table border="1"> <thead> <tr><th>PRICE</th></tr></thead> <tbody> <tr><td>1-9</td><td>\$139.83</td></tr> <tr><td>10-24</td><td>\$132.84</td></tr> <tr><td>25-49</td><td>\$125.85</td></tr> <tr><td>NEW 50+</td><td>\$120.25</td></tr> </tbody> </table> <p>Slide-On BMA Jack to SMA Female 2 Hole Flange VSWR 1.25:1 to 18 GHz Model No: <a href="#">PE91399</a></p>	PRICE	1-9	\$139.83	10-24	\$132.84	25-49	\$125.85	NEW 50+	\$120.25	<p><b>BNC In-Series</b></p> 		 <table border="1"> <thead> <tr><th>PRICE</th></tr></thead> <tbody> <tr><td>1-24</td><td>\$20.91</td></tr> <tr><td>25-49</td><td>\$19.86</td></tr> <tr><td>50-99</td><td>\$18.82</td></tr> <tr><td>100+</td><td>\$17.98</td></tr> </tbody> </table> <p>BNC Male to BNC Male VSWR 1.3:1 to 1,000 MHz Model No: <a href="#">PE9000</a></p>	PRICE	1-24	\$20.91	25-49	\$19.86	50-99	\$18.82	100+	\$17.98	 <table border="1"> <thead> <tr><th>PRICE</th></tr></thead> <tbody> <tr><td>1-24</td><td>\$56.85</td></tr> <tr><td>25-49</td><td>\$54.01</td></tr> <tr><td>50-99</td><td>\$51.17</td></tr> <tr><td>100+</td><td>\$48.89</td></tr> </tbody> </table> <p>BNC Male to BNC Male Right Angle Max. Freq. 4 GHz Model No: <a href="#">PE9758</a></p>	PRICE	1-24	\$56.85	25-49	\$54.01	50-99	\$51.17	100+	\$48.89								
	PRICE																																																	
1-9	\$154.33																																																	
10-24	\$146.61																																																	
25-49	\$138.90																																																	
NEW 50+	\$132.72																																																	
PRICE																																																		
1-9	\$139.83																																																	
10-24	\$132.84																																																	
25-49	\$125.85																																																	
NEW 50+	\$120.25																																																	
PRICE																																																		
1-24	\$20.91																																																	
25-49	\$19.86																																																	
50-99	\$18.82																																																	
100+	\$17.98																																																	
PRICE																																																		
1-24	\$56.85																																																	
25-49	\$54.01																																																	
50-99	\$51.17																																																	
100+	\$48.89																																																	
2	 <table border="1"> <thead> <tr><th>PRICE</th></tr></thead> <tbody> <tr><td>1-24</td><td>\$35.02</td></tr> <tr><td>25-49</td><td>\$33.27</td></tr> <tr><td>50-99</td><td>\$31.52</td></tr> <tr><td>100+</td><td>\$30.12</td></tr> </tbody> </table> <p>BNC Male to BNC Female VSWR 1.3:1 to 4 GHz Model No: <a href="#">PE9269</a></p>	PRICE	1-24	\$35.02	25-49	\$33.27	50-99	\$31.52	100+	\$30.12	 <table border="1"> <thead> <tr><th>PRICE</th></tr></thead> <tbody> <tr><td>1-24</td><td>\$27.06</td></tr> <tr><td>25-49</td><td>\$25.71</td></tr> <tr><td>50-99</td><td>\$24.35</td></tr> <tr><td>100+</td><td>\$23.27</td></tr> </tbody> </table> <p>BNC Male to BNC Female Right Angle Max. Freq. 4 GHz Model No: <a href="#">PE9085</a></p>	PRICE	1-24	\$27.06	25-49	\$25.71	50-99	\$24.35	100+	\$23.27	 <table border="1"> <thead> <tr><th>PRICE</th></tr></thead> <tbody> <tr><td>1-24</td><td>\$49.68</td></tr> <tr><td>25-49</td><td>\$47.20</td></tr> <tr><td>50-99</td><td>\$44.71</td></tr> <tr><td>100+</td><td>\$42.72</td></tr> </tbody> </table> <p>BNC Male to BNC Female Tee VSWR 2.1:1 to 100 MHz Model No: <a href="#">PE9174</a></p>	PRICE	1-24	\$49.68	25-49	\$47.20	50-99	\$44.71	100+	\$42.72	 <table border="1"> <thead> <tr><th>PRICE</th></tr></thead> <tbody> <tr><td>1-24</td><td>\$50.45</td></tr> <tr><td>25-49</td><td>\$47.93</td></tr> <tr><td>50-99</td><td>\$45.41</td></tr> <tr><td>100+</td><td>\$43.39</td></tr> </tbody> </table> <p>BNC Male to BNC Female Tee Max. Freq. 100 MHz Model No: <a href="#">PE9484</a></p>	PRICE	1-24	\$50.45	25-49	\$47.93	50-99	\$45.41	100+	\$43.39	 <table border="1"> <thead> <tr><th>PRICE</th></tr></thead> <tbody> <tr><td>1-24</td><td>\$20.92</td></tr> <tr><td>25-49</td><td>\$19.87</td></tr> <tr><td>50-99</td><td>\$18.83</td></tr> <tr><td>100+</td><td>\$17.99</td></tr> </tbody> </table> <p>BNC Female to BNC Male Tee Max. Freq. 4 GHz Model No: <a href="#">PE9001</a></p>	PRICE	1-24	\$20.92	25-49	\$19.87	50-99	\$18.83	100+	\$17.99
	PRICE																																																	
1-24	\$35.02																																																	
25-49	\$33.27																																																	
50-99	\$31.52																																																	
100+	\$30.12																																																	
PRICE																																																		
1-24	\$27.06																																																	
25-49	\$25.71																																																	
50-99	\$24.35																																																	
100+	\$23.27																																																	
PRICE																																																		
1-24	\$49.68																																																	
25-49	\$47.20																																																	
50-99	\$44.71																																																	
100+	\$42.72																																																	
PRICE																																																		
1-24	\$50.45																																																	
25-49	\$47.93																																																	
50-99	\$45.41																																																	
100+	\$43.39																																																	
PRICE																																																		
1-24	\$20.92																																																	
25-49	\$19.87																																																	
50-99	\$18.83																																																	
100+	\$17.99																																																	
3	 <table border="1"> <thead> <tr><th>PRICE</th></tr></thead> <tbody> <tr><td>1-24</td><td>\$11.51</td></tr> <tr><td>25-49</td><td>\$10.93</td></tr> <tr><td>50-99</td><td>\$10.36</td></tr> <tr><td>100+</td><td>\$9.90</td></tr> </tbody> </table> <p>BNC Female to BNC Female VSWR 1.3:1 to 4 GHz Model No: <a href="#">PE9084</a></p>	PRICE	1-24	\$11.51	25-49	\$10.93	50-99	\$10.36	100+	\$9.90	 <table border="1"> <thead> <tr><th>PRICE</th></tr></thead> <tbody> <tr><td>1-24</td><td>\$22.91</td></tr> <tr><td>25-49</td><td>\$21.76</td></tr> <tr><td>50-99</td><td>\$20.62</td></tr> <tr><td>100+</td><td>\$19.70</td></tr> </tbody> </table> <p>BNC Female to BNC Female Tee VSWR 2.1:1 to 100 MHz Model No: <a href="#">PE9003</a></p>	PRICE	1-24	\$22.91	25-49	\$21.76	50-99	\$20.62	100+	\$19.70	 <table border="1"> <thead> <tr><th>PRICE</th></tr></thead> <tbody> <tr><td>1-24</td><td>\$83.77</td></tr> <tr><td>25-49</td><td>\$79.58</td></tr> <tr><td>50-99</td><td>\$75.39</td></tr> <tr><td>100+</td><td>\$72.04</td></tr> </tbody> </table> <p>BNC Female to BNC Female Bulkhead-Mounting Hole B06 Model No: <a href="#">PE9420</a></p>	PRICE	1-24	\$83.77	25-49	\$79.58	50-99	\$75.39	100+	\$72.04	 <table border="1"> <thead> <tr><th>PRICE</th></tr></thead> <tbody> <tr><td>1-24</td><td>\$25.64</td></tr> <tr><td>25-49</td><td>\$24.36</td></tr> <tr><td>50-99</td><td>\$23.08</td></tr> <tr><td>100+</td><td>\$22.05</td></tr> </tbody> </table> <p>BNC Female to BNC Female Bulkhead VSWR 1.5:1 to 4 GHz Model No: <a href="#">PE9093</a></p>	PRICE	1-24	\$25.64	25-49	\$24.36	50-99	\$23.08	100+	\$22.05	 <table border="1"> <thead> <tr><th>PRICE</th></tr></thead> <tbody> <tr><td>1-24</td><td>\$28.22</td></tr> <tr><td>25-49</td><td>\$26.81</td></tr> <tr><td>50-99</td><td>\$25.40</td></tr> <tr><td>100+</td><td>\$24.27</td></tr> </tbody> </table> <p>BNC Female to BNC Female Bulkhead VSWR 1.5:1 to 4 GHz Model No: <a href="#">PE9172</a></p>	PRICE	1-24	\$28.22	25-49	\$26.81	50-99	\$25.40	100+	\$24.27
	PRICE																																																	
1-24	\$11.51																																																	
25-49	\$10.93																																																	
50-99	\$10.36																																																	
100+	\$9.90																																																	
PRICE																																																		
1-24	\$22.91																																																	
25-49	\$21.76																																																	
50-99	\$20.62																																																	
100+	\$19.70																																																	
PRICE																																																		
1-24	\$83.77																																																	
25-49	\$79.58																																																	
50-99	\$75.39																																																	
100+	\$72.04																																																	
PRICE																																																		
1-24	\$25.64																																																	
25-49	\$24.36																																																	
50-99	\$23.08																																																	
100+	\$22.05																																																	
PRICE																																																		
1-24	\$28.22																																																	
25-49	\$26.81																																																	
50-99	\$25.40																																																	
100+	\$24.27																																																	
4	 <table border="1"> <thead> <tr><th>PRICE</th></tr></thead> <tbody> <tr><td>1-24</td><td>\$21.24</td></tr> <tr><td>25-49</td><td>\$20.18</td></tr> <tr><td>50-99</td><td>\$19.12</td></tr> <tr><td>100+</td><td>\$18.27</td></tr> </tbody> </table> <p>BNC Female to BNC Female 4 Hole Flange-Mounting Hole A03 VSWR 1.3:1 to 4 GHz Model No: <a href="#">PE9106</a></p>	PRICE	1-24	\$21.24	25-49	\$20.18	50-99	\$19.12	100+	\$18.27	<p><b>Reverse Polarity BNC In-Series</b></p> 		 <table border="1"> <thead> <tr><th>PRICE</th></tr></thead> <tbody> <tr><td>1-24</td><td>\$45.04</td></tr> <tr><td>25-49</td><td>\$42.79</td></tr> <tr><td>50-99</td><td>\$40.54</td></tr> <tr><td>100+</td><td>\$38.73</td></tr> </tbody> </table> <p>BNC Male to Rev. Pol. BNC Female Model No: <a href="#">PE9530</a></p>	PRICE	1-24	\$45.04	25-49	\$42.79	50-99	\$40.54	100+	\$38.73	 <table border="1"> <thead> <tr><th>PRICE</th></tr></thead> <tbody> <tr><td>1-24</td><td>\$56.30</td></tr> <tr><td>25-49</td><td>\$53.49</td></tr> <tr><td>50-99</td><td>\$50.67</td></tr> <tr><td>100+</td><td>\$48.42</td></tr> </tbody> </table> <p>BNC Female to Rev. Pol. BNC Male Model No: <a href="#">PE9529</a></p>	PRICE	1-24	\$56.30	25-49	\$53.49	50-99	\$50.67	100+	\$48.42																		
	PRICE																																																	
1-24	\$21.24																																																	
25-49	\$20.18																																																	
50-99	\$19.12																																																	
100+	\$18.27																																																	
PRICE																																																		
1-24	\$45.04																																																	
25-49	\$42.79																																																	
50-99	\$40.54																																																	
100+	\$38.73																																																	
PRICE																																																		
1-24	\$56.30																																																	
25-49	\$53.49																																																	
50-99	\$50.67																																																	
100+	\$48.42																																																	
5	 <table border="1"> <thead> <tr><th>PRICE</th></tr></thead> <tbody> <tr><td>1-24</td><td>\$24.15</td></tr> <tr><td>25-49</td><td>\$22.94</td></tr> <tr><td>50-99</td><td>\$21.74</td></tr> <tr><td>100+</td><td>\$20.77</td></tr> </tbody> </table> <p>BNC Male to Double Banana Binding Post Jack Model No: <a href="#">PE9011</a></p>	PRICE	1-24	\$24.15	25-49	\$22.94	50-99	\$21.74	100+	\$20.77	 <table border="1"> <thead> <tr><th>PRICE</th></tr></thead> <tbody> <tr><td>1-24</td><td>\$82.16</td></tr> <tr><td>25-49</td><td>\$78.05</td></tr> <tr><td>50-99</td><td>\$73.94</td></tr> <tr><td>100+</td><td>\$70.66</td></tr> </tbody> </table> <p>BNC Male to BNC Triax Female Model No: <a href="#">PE91104</a></p>	PRICE	1-24	\$82.16	25-49	\$78.05	50-99	\$73.94	100+	\$70.66	 <table border="1"> <thead> <tr><th>PRICE</th></tr></thead> <tbody> <tr><td>1-24</td><td>\$100.33</td></tr> <tr><td>25-49</td><td>\$95.31</td></tr> <tr><td>50-99</td><td>\$90.30</td></tr> <tr><td>100+</td><td>\$86.28</td></tr> </tbody> </table> <p>BNC Male to C Male Model No: <a href="#">PE9536</a></p>	PRICE	1-24	\$100.33	25-49	\$95.31	50-99	\$90.30	100+	\$86.28	 <table border="1"> <thead> <tr><th>PRICE</th></tr></thead> <tbody> <tr><td>1-24</td><td>\$56.51</td></tr> <tr><td>25-49</td><td>\$53.68</td></tr> <tr><td>50-99</td><td>\$50.86</td></tr> <tr><td>100+</td><td>\$48.60</td></tr> </tbody> </table> <p>BNC Male to C Female Model No: <a href="#">PE9109</a></p>	PRICE	1-24	\$56.51	25-49	\$53.68	50-99	\$50.86	100+	\$48.60	 <table border="1"> <thead> <tr><th>PRICE</th></tr></thead> <tbody> <tr><td>1-24</td><td>\$23.58</td></tr> <tr><td>25-49</td><td>\$22.40</td></tr> <tr><td>50-99</td><td>\$21.22</td></tr> <tr><td>100+</td><td>\$20.28</td></tr> </tbody> </table> <p>BNC Male to 75 Ohm F Male Model No: <a href="#">PE9152</a></p>	PRICE	1-24	\$23.58	25-49	\$22.40	50-99	\$21.22	100+	\$20.28
	PRICE																																																	
1-24	\$24.15																																																	
25-49	\$22.94																																																	
50-99	\$21.74																																																	
100+	\$20.77																																																	
PRICE																																																		
1-24	\$82.16																																																	
25-49	\$78.05																																																	
50-99	\$73.94																																																	
100+	\$70.66																																																	
PRICE																																																		
1-24	\$100.33																																																	
25-49	\$95.31																																																	
50-99	\$90.30																																																	
100+	\$86.28																																																	
PRICE																																																		
1-24	\$56.51																																																	
25-49	\$53.68																																																	
50-99	\$50.86																																																	
100+	\$48.60																																																	
PRICE																																																		
1-24	\$23.58																																																	
25-49	\$22.40																																																	
50-99	\$21.22																																																	
100+	\$20.28																																																	
6	 <table border="1"> <thead> <tr><th>PRICE</th></tr></thead> <tbody> <tr><td>1-24</td><td>\$29.72</td></tr> <tr><td>25-49</td><td>\$28.23</td></tr> <tr><td>50-99</td><td>\$26.75</td></tr> <tr><td>100+</td><td>\$25.56</td></tr> </tbody> </table> <p>BNC Male to 75 Ohm F Female VSWR 1.5:1 to 300 MHz Model No: <a href="#">PE9150</a></p>	PRICE	1-24	\$29.72	25-49	\$28.23	50-99	\$26.75	100+	\$25.56	 <table border="1"> <thead> <tr><th>PRICE</th></tr></thead> <tbody> <tr><td>1-9</td><td>\$112.38</td></tr> <tr><td>10-24</td><td>\$106.76</td></tr> <tr><td>25-49</td><td>\$101.14</td></tr> <tr><td>50+</td><td>\$96.65</td></tr> </tbody> </table> <p>BNC Male to MHV Female Model No: <a href="#">PE9406</a></p>	PRICE	1-9	\$112.38	10-24	\$106.76	25-49	\$101.14	50+	\$96.65	 <table border="1"> <thead> <tr><th>PRICE</th></tr></thead> <tbody> <tr><td>1-24</td><td>\$20.78</td></tr> <tr><td>25-49</td><td>\$19.74</td></tr> <tr><td>50-99</td><td>\$18.70</td></tr> <tr><td>100+</td><td>\$17.87</td></tr> </tbody> </table> <p>BNC Male to 75 Ohm Push-On RCA Jack Max. Freq. 250 MHz Model No: <a href="#">PE9171</a></p>	PRICE	1-24	\$20.78	25-49	\$19.74	50-99	\$18.70	100+	\$17.87	 <table border="1"> <thead> <tr><th>PRICE</th></tr></thead> <tbody> <tr><td>1-24</td><td>\$68.65</td></tr> <tr><td>25-49</td><td>\$65.22</td></tr> <tr><td>50-99</td><td>\$61.79</td></tr> <tr><td>100+</td><td>\$59.04</td></tr> </tbody> </table> <p>BNC Male to 75 Ohm SMB Plug Model No: <a href="#">PE9230</a></p>	PRICE	1-24	\$68.65	25-49	\$65.22	50-99	\$61.79	100+	\$59.04	 <table border="1"> <thead> <tr><th>PRICE</th></tr></thead> <tbody> <tr><td>1-24</td><td>\$66.98</td></tr> <tr><td>25-49</td><td>\$63.63</td></tr> <tr><td>50-99</td><td>\$60.28</td></tr> <tr><td>100+</td><td>\$57.60</td></tr> </tbody> </table> <p>BNC Male to 75 Ohm SMC Plug Model No: <a href="#">PE9234</a></p>	PRICE	1-24	\$66.98	25-49	\$63.63	50-99	\$60.28	100+	\$57.60
	PRICE																																																	
1-24	\$29.72																																																	
25-49	\$28.23																																																	
50-99	\$26.75																																																	
100+	\$25.56																																																	
PRICE																																																		
1-9	\$112.38																																																	
10-24	\$106.76																																																	
25-49	\$101.14																																																	
50+	\$96.65																																																	
PRICE																																																		
1-24	\$20.78																																																	
25-49	\$19.74																																																	
50-99	\$18.70																																																	
100+	\$17.87																																																	
PRICE																																																		
1-24	\$68.65																																																	
25-49	\$65.22																																																	
50-99	\$61.79																																																	
100+	\$59.04																																																	
PRICE																																																		
1-24	\$66.98																																																	
25-49	\$63.63																																																	
50-99	\$60.28																																																	
100+	\$57.60																																																	
7	 <table border="1"> <thead> <tr><th>PRICE</th></tr></thead> <tbody> <tr><td>1-24</td><td>\$91.01</td></tr> <tr><td>25-49</td><td>\$86.46</td></tr> <tr><td>50-99</td><td>\$81.91</td></tr> <tr><td>100+</td><td>\$78.27</td></tr> </tbody> </table> <p>BNC Male to 75 Ohm SMC Jack Model No: <a href="#">PE91044</a></p>	PRICE	1-24	\$91.01	25-49	\$86.46	50-99	\$81.91	100+	\$78.27	 <table border="1"> <thead> <tr><th>PRICE</th></tr></thead> <tbody> <tr><td>1-24</td><td>\$40.37</td></tr> <tr><td>25-49</td><td>\$38.35</td></tr> <tr><td>50-99</td><td>\$36.33</td></tr> <tr><td>100+</td><td>\$34.72</td></tr> </tbody> </table> <p>BNC Female to C Male VSWR 1.3:1 to 4 GHz Model No: <a href="#">PE9087</a></p>	PRICE	1-24	\$40.37	25-49	\$38.35	50-99	\$36.33	100+	\$34.72	 <table border="1"> <thead> <tr><th>PRICE</th></tr></thead> <tbody> <tr><td>1-24</td><td>\$97.86</td></tr> <tr><td>25-49</td><td>\$92.97</td></tr> <tr><td>50-99</td><td>\$88.07</td></tr> <tr><td>100+</td><td>\$84.16</td></tr> </tbody> </table> <p>BNC Female to C Female Model No: <a href="#">PE9537</a></p>	PRICE	1-24	\$97.86	25-49	\$92.97	50-99	\$88.07	100+	\$84.16	 <table border="1"> <thead> <tr><th>PRICE</th></tr></thead> <tbody> <tr><td>1-24</td><td>\$99.02</td></tr> <tr><td>25-49</td><td>\$94.07</td></tr> <tr><td>50-99</td><td>\$89.12</td></tr> <tr><td>100+</td><td>\$85.16</td></tr> </tbody> </table> <p>BNC Female to C Female Bulkhead-Mounting Hole G01 Model No: <a href="#">PE9204</a></p>	PRICE	1-24	\$99.02	25-49	\$94.07	50-99	\$89.12	100+	\$85.16	 <table border="1"> <thead> <tr><th>PRICE</th></tr></thead> <tbody> <tr><td>1-24</td><td>\$23.36</td></tr> <tr><td>25-49</td><td>\$22.19</td></tr> <tr><td>50-99</td><td>\$21.02</td></tr> <tr><td>100+</td><td>\$20.09</td></tr> </tbody> </table> <p>BNC Female to 75 Ohm F Male VSWR 1.3:1 to 500 MHz Model No: <a href="#">PE9151</a></p>	PRICE	1-24	\$23.36	25-49	\$22.19	50-99	\$21.02	100+	\$20.09
	PRICE																																																	
1-24	\$91.01																																																	
25-49	\$86.46																																																	
50-99	\$81.91																																																	
100+	\$78.27																																																	
PRICE																																																		
1-24	\$40.37																																																	
25-49	\$38.35																																																	
50-99	\$36.33																																																	
100+	\$34.72																																																	
PRICE																																																		
1-24	\$97.86																																																	
25-49	\$92.97																																																	
50-99	\$88.07																																																	
100+	\$84.16																																																	
PRICE																																																		
1-24	\$99.02																																																	
25-49	\$94.07																																																	
50-99	\$89.12																																																	
100+	\$85.16																																																	
PRICE																																																		
1-24	\$23.36																																																	
25-49	\$22.19																																																	
50-99	\$21.02																																																	
100+	\$20.09																																																	

# ADAPTERS

See Adapter Locator on Pages 8-13

See Page 369 for Mounting Holes

Adapters

See Our Website For Current Pricing & Real-Time Stock Availability!

	A	B	C	D	E																																																		
1	 <table border="1"> <thead> <tr><th colspan="2">PRICE</th></tr> </thead> <tbody> <tr><td>1-24</td><td>\$18.21</td></tr> <tr><td>25-49</td><td>\$17.30</td></tr> <tr><td>50-99</td><td>\$16.39</td></tr> <tr><td>100+</td><td>\$15.66</td></tr> </tbody> </table> <p>BNC Female to 75 Ohm F Female</p> <p>Model No: <a href="#">PE9153</a></p>	PRICE		1-24	\$18.21	25-49	\$17.30	50-99	\$16.39	100+	\$15.66	 <table border="1"> <thead> <tr><th colspan="2">PRICE</th></tr> </thead> <tbody> <tr><td>1-24</td><td>\$18.53</td></tr> <tr><td>25-49</td><td>\$17.60</td></tr> <tr><td>50-99</td><td>\$16.68</td></tr> <tr><td>100+</td><td>\$15.94</td></tr> </tbody> </table> <p>BNC Female to 75 Ohm RCA Plug</p> <p>Max. Freq. 250 MHz</p> <p>Model No: <a href="#">PE9158</a></p>	PRICE		1-24	\$18.53	25-49	\$17.60	50-99	\$16.68	100+	\$15.94	 <table border="1"> <thead> <tr><th colspan="2">PRICE</th></tr> </thead> <tbody> <tr><td>1-24</td><td>\$13.36</td></tr> <tr><td>25-49</td><td>\$12.69</td></tr> <tr><td>50-99</td><td>\$12.02</td></tr> <tr><td>100+</td><td>\$11.49</td></tr> </tbody> </table> <p>BNC Female to 75 Ohm RCA Jack</p> <p>Max. Freq. 250 MHz</p> <p>Model No: <a href="#">PE9015</a></p>	PRICE		1-24	\$13.36	25-49	\$12.69	50-99	\$12.02	100+	\$11.49	 <table border="1"> <thead> <tr><th colspan="2">PRICE</th></tr> </thead> <tbody> <tr><td>1-24</td><td>\$66.06</td></tr> <tr><td>25-49</td><td>\$62.76</td></tr> <tr><td>50-99</td><td>\$59.45</td></tr> <tr><td>100+</td><td>\$56.81</td></tr> </tbody> </table> <p>BNC Female to 75 Ohm SMB Jack</p> <p>VSWR 1.2:1 to 4 GHz</p> <p>Model No: <a href="#">PE9231</a></p>	PRICE		1-24	\$66.06	25-49	\$62.76	50-99	\$59.45	100+	\$56.81	 <table border="1"> <thead> <tr><th colspan="2">PRICE</th></tr> </thead> <tbody> <tr><td>1-24</td><td>\$74.67</td></tr> <tr><td>25-49</td><td>\$70.94</td></tr> <tr><td>50-99</td><td>\$67.20</td></tr> <tr><td>100+</td><td>\$64.22</td></tr> </tbody> </table> <p>BNC Female to 75 Ohm SMC Plug</p> <p>Model No: <a href="#">PE9236</a></p>	PRICE		1-24	\$74.67	25-49	\$70.94	50-99	\$67.20	100+	\$64.22
PRICE																																																							
1-24	\$18.21																																																						
25-49	\$17.30																																																						
50-99	\$16.39																																																						
100+	\$15.66																																																						
PRICE																																																							
1-24	\$18.53																																																						
25-49	\$17.60																																																						
50-99	\$16.68																																																						
100+	\$15.94																																																						
PRICE																																																							
1-24	\$13.36																																																						
25-49	\$12.69																																																						
50-99	\$12.02																																																						
100+	\$11.49																																																						
PRICE																																																							
1-24	\$66.06																																																						
25-49	\$62.76																																																						
50-99	\$59.45																																																						
100+	\$56.81																																																						
PRICE																																																							
1-24	\$74.67																																																						
25-49	\$70.94																																																						
50-99	\$67.20																																																						
100+	\$64.22																																																						
2	<p><b>C In-Series</b></p> <p>→</p>	 <table border="1"> <thead> <tr><th colspan="2">PRICE</th></tr> </thead> <tbody> <tr><td>1-24</td><td>\$115.39</td></tr> <tr><td>25-49</td><td>\$109.62</td></tr> <tr><td>50-99</td><td>\$103.85</td></tr> <tr><td>100+</td><td>\$99.24</td></tr> </tbody> </table> <p>C Male to C Male</p> <p>Model No: <a href="#">PE9300</a></p>	PRICE		1-24	\$115.39	25-49	\$109.62	50-99	\$103.85	100+	\$99.24	 <table border="1"> <thead> <tr><th colspan="2">PRICE</th></tr> </thead> <tbody> <tr><td>1-24</td><td>\$90.81</td></tr> <tr><td>25-49</td><td>\$86.27</td></tr> <tr><td>50-99</td><td>\$81.73</td></tr> <tr><td>100+</td><td>\$78.10</td></tr> </tbody> </table> <p>C Male to C Female Right Angle</p> <p>Model No: <a href="#">PE9293</a></p>	PRICE		1-24	\$90.81	25-49	\$86.27	50-99	\$81.73	100+	\$78.10	 <table border="1"> <thead> <tr><th colspan="2">PRICE</th></tr> </thead> <tbody> <tr><td>1-24</td><td>\$89.46</td></tr> <tr><td>25-49</td><td>\$84.99</td></tr> <tr><td>50-99</td><td>\$80.51</td></tr> <tr><td>100+</td><td>\$76.94</td></tr> </tbody> </table> <p>C Female to C Male Tee</p> <p>Model No: <a href="#">PE9207</a></p>	PRICE		1-24	\$89.46	25-49	\$84.99	50-99	\$80.51	100+	\$76.94	 <table border="1"> <thead> <tr><th colspan="2">PRICE</th></tr> </thead> <tbody> <tr><td>1-24</td><td>\$49.13</td></tr> <tr><td>25-49</td><td>\$46.67</td></tr> <tr><td>50-99</td><td>\$44.22</td></tr> <tr><td>100+</td><td>\$42.25</td></tr> </tbody> </table> <p>C Female to C Female</p> <p>Model No: <a href="#">PE9208</a></p>	PRICE		1-24	\$49.13	25-49	\$46.67	50-99	\$44.22	100+	\$42.25										
PRICE																																																							
1-24	\$115.39																																																						
25-49	\$109.62																																																						
50-99	\$103.85																																																						
100+	\$99.24																																																						
PRICE																																																							
1-24	\$90.81																																																						
25-49	\$86.27																																																						
50-99	\$81.73																																																						
100+	\$78.10																																																						
PRICE																																																							
1-24	\$89.46																																																						
25-49	\$84.99																																																						
50-99	\$80.51																																																						
100+	\$76.94																																																						
PRICE																																																							
1-24	\$49.13																																																						
25-49	\$46.67																																																						
50-99	\$44.22																																																						
100+	\$42.25																																																						
3	 <table border="1"> <thead> <tr><th colspan="2">PRICE</th></tr> </thead> <tbody> <tr><td>1-24</td><td>\$119.65</td></tr> <tr><td>25-49</td><td>\$113.67</td></tr> <tr><td>50-99</td><td>\$107.69</td></tr> <tr><td>100+</td><td>\$102.90</td></tr> </tbody> </table> <p>C Female to C Female Tee</p> <p>Model No: <a href="#">PE9294</a></p>	PRICE		1-24	\$119.65	25-49	\$113.67	50-99	\$107.69	100+	\$102.90	 <table border="1"> <thead> <tr><th colspan="2">PRICE</th></tr> </thead> <tbody> <tr><td>1-24</td><td>\$117.32</td></tr> <tr><td>25-49</td><td>\$111.45</td></tr> <tr><td>50-99</td><td>\$105.59</td></tr> <tr><td>100+</td><td>\$100.90</td></tr> </tbody> </table> <p>C Female to C Female Bulkhead-Mounting Hole B07</p> <p>Model No: <a href="#">PE9186</a></p>	PRICE		1-24	\$117.32	25-49	\$111.45	50-99	\$105.59	100+	\$100.90	<p><b>D-Sub In-Series</b></p> <p>→</p>	 <table border="1"> <thead> <tr><th colspan="2">PRICE</th></tr> </thead> <tbody> <tr><td>1-24</td><td>\$50.01</td></tr> <tr><td>25-49</td><td>\$47.51</td></tr> <tr><td>50-99</td><td>\$45.01</td></tr> <tr><td>100+</td><td>\$43.01</td></tr> </tbody> </table> <p>D-Sub Plug to D-Sub Plug</p> <p>Model No: <a href="#">PE9688</a></p>	PRICE		1-24	\$50.01	25-49	\$47.51	50-99	\$45.01	100+	\$43.01	 <table border="1"> <thead> <tr><th colspan="2">PRICE</th></tr> </thead> <tbody> <tr><td>1-24</td><td>\$49.39</td></tr> <tr><td>25-49</td><td>\$46.92</td></tr> <tr><td>50-99</td><td>\$44.45</td></tr> <tr><td>100+</td><td>\$42.48</td></tr> </tbody> </table> <p>D-Sub Plug to D-Sub Receptacle</p> <p>Model No: <a href="#">PE9687</a></p>	PRICE		1-24	\$49.39	25-49	\$46.92	50-99	\$44.45	100+	\$42.48										
PRICE																																																							
1-24	\$119.65																																																						
25-49	\$113.67																																																						
50-99	\$107.69																																																						
100+	\$102.90																																																						
PRICE																																																							
1-24	\$117.32																																																						
25-49	\$111.45																																																						
50-99	\$105.59																																																						
100+	\$100.90																																																						
PRICE																																																							
1-24	\$50.01																																																						
25-49	\$47.51																																																						
50-99	\$45.01																																																						
100+	\$43.01																																																						
PRICE																																																							
1-24	\$49.39																																																						
25-49	\$46.92																																																						
50-99	\$44.45																																																						
100+	\$42.48																																																						
4	 <table border="1"> <thead> <tr><th colspan="2">PRICE</th></tr> </thead> <tbody> <tr><td>1-24</td><td>\$70.46</td></tr> <tr><td>25-49</td><td>\$66.94</td></tr> <tr><td>50-99</td><td>\$63.41</td></tr> <tr><td>100+</td><td>\$60.60</td></tr> </tbody> </table> <p>D-Sub Receptacle to D-Sub Receptacle</p> <p>Model No: <a href="#">PE9689</a></p>	PRICE		1-24	\$70.46	25-49	\$66.94	50-99	\$63.41	100+	\$60.60	<p><b>FME In-Series</b></p> <p>→</p>	 <table border="1"> <thead> <tr><th colspan="2">PRICE</th></tr> </thead> <tbody> <tr><td>1-24</td><td>\$20.43</td></tr> <tr><td>25-49</td><td>\$19.41</td></tr> <tr><td>50-99</td><td>\$18.39</td></tr> <tr><td>100+</td><td>\$17.57</td></tr> </tbody> </table> <p>FME Plug to FME Plug</p> <p>Model No: <a href="#">PE9696</a></p>	PRICE		1-24	\$20.43	25-49	\$19.41	50-99	\$18.39	100+	\$17.57	<p><b>FME Between Series</b></p> <p>→</p>	 <table border="1"> <thead> <tr><th colspan="2">PRICE</th></tr> </thead> <tbody> <tr><td>1-24</td><td>\$20.43</td></tr> <tr><td>25-49</td><td>\$19.41</td></tr> <tr><td>50-99</td><td>\$18.39</td></tr> <tr><td>100+</td><td>\$17.57</td></tr> </tbody> </table> <p>FME Plug to BNC Male</p> <p>Model No: <a href="#">PE9697</a></p>	PRICE		1-24	\$20.43	25-49	\$19.41	50-99	\$18.39	100+	\$17.57																				
PRICE																																																							
1-24	\$70.46																																																						
25-49	\$66.94																																																						
50-99	\$63.41																																																						
100+	\$60.60																																																						
PRICE																																																							
1-24	\$20.43																																																						
25-49	\$19.41																																																						
50-99	\$18.39																																																						
100+	\$17.57																																																						
PRICE																																																							
1-24	\$20.43																																																						
25-49	\$19.41																																																						
50-99	\$18.39																																																						
100+	\$17.57																																																						
5	 <table border="1"> <thead> <tr><th colspan="2">PRICE</th></tr> </thead> <tbody> <tr><td>1-24</td><td>\$20.86</td></tr> <tr><td>25-49</td><td>\$19.82</td></tr> <tr><td>50-99</td><td>\$18.77</td></tr> <tr><td>100+</td><td>\$17.94</td></tr> </tbody> </table> <p>FME Plug to BNC Male Right Angle</p> <p>Model No: <a href="#">PE9698</a></p>	PRICE		1-24	\$20.86	25-49	\$19.82	50-99	\$18.77	100+	\$17.94	 <table border="1"> <thead> <tr><th colspan="2">PRICE</th></tr> </thead> <tbody> <tr><td>1-24</td><td>\$20.43</td></tr> <tr><td>25-49</td><td>\$19.41</td></tr> <tr><td>50-99</td><td>\$18.39</td></tr> <tr><td>100+</td><td>\$17.57</td></tr> </tbody> </table> <p>FME Jack to BNC Male</p> <p>Model No: <a href="#">PE9711</a></p>	PRICE		1-24	\$20.43	25-49	\$19.41	50-99	\$18.39	100+	\$17.57	 <table border="1"> <thead> <tr><th colspan="2">PRICE</th></tr> </thead> <tbody> <tr><td>1-24</td><td>\$16.30</td></tr> <tr><td>25-49</td><td>\$15.49</td></tr> <tr><td>50-99</td><td>\$14.67</td></tr> <tr><td>100+</td><td>\$14.02</td></tr> </tbody> </table> <p>FME Jack to BNC Female</p> <p>Model No: <a href="#">PE9712</a></p>	PRICE		1-24	\$16.30	25-49	\$15.49	50-99	\$14.67	100+	\$14.02	<p><b>GR874 In-Series</b></p> <p>→</p>	 <table border="1"> <thead> <tr><th colspan="2">PRICE</th></tr> </thead> <tbody> <tr><td>1-9</td><td>\$345.96</td></tr> <tr><td>10-24</td><td>\$328.66</td></tr> <tr><td>25-49</td><td>\$311.36</td></tr> <tr><td>50+</td><td>\$297.53</td></tr> </tbody> </table> <p>GR874 Sexless to GR874 Sexless Right Angle</p> <p>Model No: <a href="#">PE9286</a></p>	PRICE		1-9	\$345.96	10-24	\$328.66	25-49	\$311.36	50+	\$297.53										
PRICE																																																							
1-24	\$20.86																																																						
25-49	\$19.82																																																						
50-99	\$18.77																																																						
100+	\$17.94																																																						
PRICE																																																							
1-24	\$20.43																																																						
25-49	\$19.41																																																						
50-99	\$18.39																																																						
100+	\$17.57																																																						
PRICE																																																							
1-24	\$16.30																																																						
25-49	\$15.49																																																						
50-99	\$14.67																																																						
100+	\$14.02																																																						
PRICE																																																							
1-9	\$345.96																																																						
10-24	\$328.66																																																						
25-49	\$311.36																																																						
50+	\$297.53																																																						
6	 <table border="1"> <thead> <tr><th colspan="2">PRICE</th></tr> </thead> <tbody> <tr><td>1-9</td><td>\$373.83</td></tr> <tr><td>10-24</td><td>\$355.14</td></tr> <tr><td>25-49</td><td>\$336.45</td></tr> <tr><td>50+</td><td>\$321.49</td></tr> </tbody> </table> <p>GR874 Sexless to GR874 Sexless Tee</p> <p>Model No: <a href="#">PE9285</a></p>	PRICE		1-9	\$373.83	10-24	\$355.14	25-49	\$336.45	50+	\$321.49	<p><b>GR874 Between Series</b></p> <p>→</p>	 <table border="1"> <thead> <tr><th colspan="2">PRICE</th></tr> </thead> <tbody> <tr><td>1-9</td><td>\$163.58</td></tr> <tr><td>10-24</td><td>\$155.40</td></tr> <tr><td>25-49</td><td>\$147.22</td></tr> <tr><td>50+</td><td>\$140.68</td></tr> </tbody> </table> <p>GR874 Sexless to BNC Male</p> <p>Model No: <a href="#">PE9223</a></p>	PRICE		1-9	\$163.58	10-24	\$155.40	25-49	\$147.22	50+	\$140.68	 <table border="1"> <thead> <tr><th colspan="2">PRICE</th></tr> </thead> <tbody> <tr><td>1-9</td><td>\$169.97</td></tr> <tr><td>10-24</td><td>\$161.47</td></tr> <tr><td>25-49</td><td>\$152.97</td></tr> <tr><td>50+</td><td>\$146.17</td></tr> </tbody> </table> <p>GR874 Sexless to BNC Female</p> <p>Model No: <a href="#">PE9222</a></p>	PRICE		1-9	\$169.97	10-24	\$161.47	25-49	\$152.97	50+	\$146.17	 <table border="1"> <thead> <tr><th colspan="2">PRICE</th></tr> </thead> <tbody> <tr><td>1-9</td><td>\$172.86</td></tr> <tr><td>10-24</td><td>\$164.22</td></tr> <tr><td>25-49</td><td>\$155.57</td></tr> <tr><td>50+</td><td>\$148.66</td></tr> </tbody> </table> <p>GR874 Sexless to C Female</p> <p>Model No: <a href="#">PE9301</a></p>	PRICE		1-9	\$172.86	10-24	\$164.22	25-49	\$155.57	50+	\$148.66										
PRICE																																																							
1-9	\$373.83																																																						
10-24	\$355.14																																																						
25-49	\$336.45																																																						
50+	\$321.49																																																						
PRICE																																																							
1-9	\$163.58																																																						
10-24	\$155.40																																																						
25-49	\$147.22																																																						
50+	\$140.68																																																						
PRICE																																																							
1-9	\$169.97																																																						
10-24	\$161.47																																																						
25-49	\$152.97																																																						
50+	\$146.17																																																						
PRICE																																																							
1-9	\$172.86																																																						
10-24	\$164.22																																																						
25-49	\$155.57																																																						
50+	\$148.66																																																						
7	<p><b>HN In-Series</b></p> <p>→</p>	 <table border="1"> <thead> <tr><th colspan="2">PRICE</th></tr> </thead> <tbody> <tr><td>1-24</td><td>\$58.67</td></tr> <tr><td>25-49</td><td>\$55.74</td></tr> <tr><td>50-99</td><td>\$52.80</td></tr> <tr><td>100+</td><td>\$50.46</td></tr> </tbody> </table> <p>HN Male to HN Male</p> <p>VSWR 1.4:1 to 3 GHz</p> <p>Model No: <a href="#">PE9210</a></p>	PRICE		1-24	\$58.67	25-49	\$55.74	50-99	\$52.80	100+	\$50.46	 <table border="1"> <thead> <tr><th colspan="2">PRICE</th></tr> </thead> <tbody> <tr><td>1-9</td><td>\$156.40</td></tr> <tr><td>10-24</td><td>\$148.58</td></tr> <tr><td>25-49</td><td>\$140.76</td></tr> <tr><td>50+</td><td>\$134.50</td></tr> </tbody> </table> <p>HN Male to HN Male Right Angle</p> <p>Model No: <a href="#">PE9577</a></p>	PRICE		1-9	\$156.40	10-24	\$148.58	25-49	\$140.76	50+	\$134.50	 <table border="1"> <thead> <tr><th colspan="2">PRICE</th></tr> </thead> <tbody> <tr><td>1-24</td><td>\$96.14</td></tr> <tr><td>25-49</td><td>\$91.33</td></tr> <tr><td>50-99</td><td>\$86.53</td></tr> <tr><td>100+</td><td>\$82.68</td></tr> </tbody> </table> <p>HN Male to HN Female</p> <p>Model No: <a href="#">PE9576</a></p>	PRICE		1-24	\$96.14	25-49	\$91.33	50-99	\$86.53	100+	\$82.68	 <table border="1"> <thead> <tr><th colspan="2">PRICE</th></tr> </thead> <tbody> <tr><td>1-24</td><td>\$65.82</td></tr> <tr><td>25-49</td><td>\$62.53</td></tr> <tr><td>50-99</td><td>\$59.24</td></tr> <tr><td>100+</td><td>\$56.61</td></tr> </tbody> </table> <p>HN Male to HN Female Right Angle</p> <p>VSWR 1.5:1 to 3 GHz</p> <p>Model No: <a href="#">PE9205</a></p>	PRICE		1-24	\$65.82	25-49	\$62.53	50-99	\$59.24	100+	\$56.61										
PRICE																																																							
1-24	\$58.67																																																						
25-49	\$55.74																																																						
50-99	\$52.80																																																						
100+	\$50.46																																																						
PRICE																																																							
1-9	\$156.40																																																						
10-24	\$148.58																																																						
25-49	\$140.76																																																						
50+	\$134.50																																																						
PRICE																																																							
1-24	\$96.14																																																						
25-49	\$91.33																																																						
50-99	\$86.53																																																						
100+	\$82.68																																																						
PRICE																																																							
1-24	\$65.82																																																						
25-49	\$62.53																																																						
50-99	\$59.24																																																						
100+	\$56.61																																																						

# ADAPTERS

See Adapter Locator on Pages 8-13

See Page 369 for Mounting Holes

	A	B	C	D	E																																													
1	 <table border="1"> <thead> <tr><th>PRICE</th></tr> </thead> <tbody> <tr><td>1-9</td><td>\$195.25</td></tr> <tr><td>10-24</td><td>\$185.49</td></tr> <tr><td>25-49</td><td>\$175.73</td></tr> <tr><td>50+</td><td>\$167.92</td></tr> </tbody> </table> <p>HN Male to HN Female Tee</p> <p>Model No: <a href="#">PE9578</a></p>	PRICE	1-9	\$195.25	10-24	\$185.49	25-49	\$175.73	50+	\$167.92	 <table border="1"> <thead> <tr><th>PRICE</th></tr> </thead> <tbody> <tr><td>1-9</td><td>\$138.56</td></tr> <tr><td>10-24</td><td>\$131.63</td></tr> <tr><td>25-49</td><td>\$124.70</td></tr> <tr><td>50+</td><td>\$119.16</td></tr> </tbody> </table> <p>HN Female to HN Male Tee</p> <p>Model No: <a href="#">PE9575</a></p>	PRICE	1-9	\$138.56	10-24	\$131.63	25-49	\$124.70	50+	\$119.16	 <table border="1"> <thead> <tr><th>PRICE</th></tr> </thead> <tbody> <tr><td>1-24</td><td>\$58.88</td></tr> <tr><td>25-49</td><td>\$55.94</td></tr> <tr><td>50-99</td><td>\$52.99</td></tr> <tr><td>100+</td><td>\$50.64</td></tr> </tbody> </table> <p>HN Female to HN Female</p> <p>Model No: <a href="#">PE9580</a></p>	PRICE	1-24	\$58.88	25-49	\$55.94	50-99	\$52.99	100+	\$50.64	 <table border="1"> <thead> <tr><th>PRICE</th></tr> </thead> <tbody> <tr><td>1-9</td><td>\$135.66</td></tr> <tr><td>10-24</td><td>\$128.88</td></tr> <tr><td>25-49</td><td>\$122.09</td></tr> <tr><td>50+</td><td>\$116.67</td></tr> </tbody> </table> <p>HN Female to HN Female Tee</p> <p>Model No: <a href="#">PE9574</a></p>	PRICE	1-9	\$135.66	10-24	\$128.88	25-49	\$122.09	50+	\$116.67	 <table border="1"> <thead> <tr><th>PRICE</th></tr> </thead> <tbody> <tr><td>1-24</td><td>\$70.29</td></tr> <tr><td>25-49</td><td>\$66.78</td></tr> <tr><td>50-99</td><td>\$63.26</td></tr> <tr><td>100+</td><td>\$60.45</td></tr> </tbody> </table> <p>HN Female to HN Female Bulkhead-Mounting Hole G03 VSWR 1.3:1 to 2 GHz</p> <p>Model No: <a href="#">PE9193</a></p>	PRICE	1-24	\$70.29	25-49	\$66.78	50-99	\$63.26	100+	\$60.45
PRICE																																																		
1-9	\$195.25																																																	
10-24	\$185.49																																																	
25-49	\$175.73																																																	
50+	\$167.92																																																	
PRICE																																																		
1-9	\$138.56																																																	
10-24	\$131.63																																																	
25-49	\$124.70																																																	
50+	\$119.16																																																	
PRICE																																																		
1-24	\$58.88																																																	
25-49	\$55.94																																																	
50-99	\$52.99																																																	
100+	\$50.64																																																	
PRICE																																																		
1-9	\$135.66																																																	
10-24	\$128.88																																																	
25-49	\$122.09																																																	
50+	\$116.67																																																	
PRICE																																																		
1-24	\$70.29																																																	
25-49	\$66.78																																																	
50-99	\$63.26																																																	
100+	\$60.45																																																	
2	<p><b>HN Between Series</b></p> <p>→</p>	 <table border="1"> <thead> <tr><th>PRICE</th></tr> </thead> <tbody> <tr><td>1-24</td><td>\$95.71</td></tr> <tr><td>25-49</td><td>\$90.92</td></tr> <tr><td>50-99</td><td>\$86.14</td></tr> <tr><td>100+</td><td>\$82.31</td></tr> </tbody> </table> <p>HN Male to BNC Male</p> <p>Model No: <a href="#">PE9567</a></p>	PRICE	1-24	\$95.71	25-49	\$90.92	50-99	\$86.14	100+	\$82.31	 <table border="1"> <thead> <tr><th>PRICE</th></tr> </thead> <tbody> <tr><td>1-24</td><td>\$63.56</td></tr> <tr><td>25-49</td><td>\$60.38</td></tr> <tr><td>50-99</td><td>\$57.20</td></tr> <tr><td>100+</td><td>\$54.66</td></tr> </tbody> </table> <p>HN Male to BNC Female VSWR 1.5:1 to 4 GHz</p> <p>Model No: <a href="#">PE9126</a></p>	PRICE	1-24	\$63.56	25-49	\$60.38	50-99	\$57.20	100+	\$54.66	 <table border="1"> <thead> <tr><th>PRICE</th></tr> </thead> <tbody> <tr><td>1-24</td><td>\$102.87</td></tr> <tr><td>25-49</td><td>\$97.73</td></tr> <tr><td>50-99</td><td>\$92.58</td></tr> <tr><td>100+</td><td>\$88.47</td></tr> </tbody> </table> <p>HN Male to C Male Max. Freq. 4 GHz</p> <p>Model No: <a href="#">PE9579</a></p>	PRICE	1-24	\$102.87	25-49	\$97.73	50-99	\$92.58	100+	\$88.47	 <table border="1"> <thead> <tr><th>PRICE</th></tr> </thead> <tbody> <tr><td>1-24</td><td>\$80.17</td></tr> <tr><td>25-49</td><td>\$76.16</td></tr> <tr><td>50-99</td><td>\$72.15</td></tr> <tr><td>100+</td><td>\$68.95</td></tr> </tbody> </table> <p>HN Male to C Female</p> <p>Model No: <a href="#">PE9296</a></p>	PRICE	1-24	\$80.17	25-49	\$76.16	50-99	\$72.15	100+	\$68.95									
PRICE																																																		
1-24	\$95.71																																																	
25-49	\$90.92																																																	
50-99	\$86.14																																																	
100+	\$82.31																																																	
PRICE																																																		
1-24	\$63.56																																																	
25-49	\$60.38																																																	
50-99	\$57.20																																																	
100+	\$54.66																																																	
PRICE																																																		
1-24	\$102.87																																																	
25-49	\$97.73																																																	
50-99	\$92.58																																																	
100+	\$88.47																																																	
PRICE																																																		
1-24	\$80.17																																																	
25-49	\$76.16																																																	
50-99	\$72.15																																																	
100+	\$68.95																																																	
3	 <table border="1"> <thead> <tr><th>PRICE</th></tr> </thead> <tbody> <tr><td>1-9</td><td>\$212.21</td></tr> <tr><td>10-24</td><td>\$201.60</td></tr> <tr><td>25-49</td><td>\$190.99</td></tr> <tr><td>50+</td><td>\$182.50</td></tr> </tbody> </table> <p>HN Male to GR874 Sexless</p> <p>Model No: <a href="#">PE9386</a></p>	PRICE	1-9	\$212.21	10-24	\$201.60	25-49	\$190.99	50+	\$182.50	 <table border="1"> <thead> <tr><th>PRICE</th></tr> </thead> <tbody> <tr><td>1-9</td><td>\$139.41</td></tr> <tr><td>10-24</td><td>\$132.44</td></tr> <tr><td>25-49</td><td>\$125.47</td></tr> <tr><td>50+</td><td>\$119.89</td></tr> </tbody> </table> <p>HN Male to MHV Female</p> <p>Model No: <a href="#">PE9264</a></p>	PRICE	1-9	\$139.41	10-24	\$132.44	25-49	\$125.47	50+	\$119.89	 <table border="1"> <thead> <tr><th>PRICE</th></tr> </thead> <tbody> <tr><td>1-24</td><td>\$67.18</td></tr> <tr><td>25-49</td><td>\$63.82</td></tr> <tr><td>50-99</td><td>\$60.46</td></tr> <tr><td>100+</td><td>\$57.77</td></tr> </tbody> </table> <p>HN Female to BNC Male</p> <p>Model No: <a href="#">PE9129</a></p>	PRICE	1-24	\$67.18	25-49	\$63.82	50-99	\$60.46	100+	\$57.77	 <table border="1"> <thead> <tr><th>PRICE</th></tr> </thead> <tbody> <tr><td>1-24</td><td>\$123.37</td></tr> <tr><td>25-49</td><td>\$117.20</td></tr> <tr><td>50-99</td><td>\$111.03</td></tr> <tr><td>100+</td><td>\$106.10</td></tr> </tbody> </table> <p>HN Female to C Male</p> <p>Model No: <a href="#">PE9212</a></p>	PRICE	1-24	\$123.37	25-49	\$117.20	50-99	\$111.03	100+	\$106.10	 <table border="1"> <thead> <tr><th>PRICE</th></tr> </thead> <tbody> <tr><td>1-9</td><td>\$204.24</td></tr> <tr><td>10-24</td><td>\$194.03</td></tr> <tr><td>25-49</td><td>\$183.82</td></tr> <tr><td>50+</td><td>\$175.65</td></tr> </tbody> </table> <p>HN Female to GR874 Sexless</p> <p>Model No: <a href="#">PE9387</a></p>	PRICE	1-9	\$204.24	10-24	\$194.03	25-49	\$183.82	50+	\$175.65
PRICE																																																		
1-9	\$212.21																																																	
10-24	\$201.60																																																	
25-49	\$190.99																																																	
50+	\$182.50																																																	
PRICE																																																		
1-9	\$139.41																																																	
10-24	\$132.44																																																	
25-49	\$125.47																																																	
50+	\$119.89																																																	
PRICE																																																		
1-24	\$67.18																																																	
25-49	\$63.82																																																	
50-99	\$60.46																																																	
100+	\$57.77																																																	
PRICE																																																		
1-24	\$123.37																																																	
25-49	\$117.20																																																	
50-99	\$111.03																																																	
100+	\$106.10																																																	
PRICE																																																		
1-9	\$204.24																																																	
10-24	\$194.03																																																	
25-49	\$183.82																																																	
50+	\$175.65																																																	
4	<p><b>LC In-Series</b></p> <p>→</p>	 <table border="1"> <thead> <tr><th>PRICE</th></tr> </thead> <tbody> <tr><td>1-9</td><td>\$302.54</td></tr> <tr><td>10-24</td><td>\$287.41</td></tr> <tr><td>25-49</td><td>\$272.29</td></tr> <tr><td>50+</td><td>\$260.18</td></tr> </tbody> </table> <p>LC Male to LC Male</p> <p>Model No: <a href="#">PE9569</a></p>	PRICE	1-9	\$302.54	10-24	\$287.41	25-49	\$272.29	50+	\$260.18	 <table border="1"> <thead> <tr><th>PRICE</th></tr> </thead> <tbody> <tr><td>1-9</td><td>\$402.08</td></tr> <tr><td>10-24</td><td>\$381.98</td></tr> <tr><td>25-49</td><td>\$361.87</td></tr> <tr><td>50+</td><td>\$345.79</td></tr> </tbody> </table> <p>LC Male to LC Female Right Angle</p> <p>Model No: <a href="#">PE9398</a></p>	PRICE	1-9	\$402.08	10-24	\$381.98	25-49	\$361.87	50+	\$345.79	 <table border="1"> <thead> <tr><th>PRICE</th></tr> </thead> <tbody> <tr><td>1-9</td><td>\$251.02</td></tr> <tr><td>10-24</td><td>\$238.47</td></tr> <tr><td>25-49</td><td>\$225.92</td></tr> <tr><td>50+</td><td>\$215.88</td></tr> </tbody> </table> <p>LC Female to LC Female</p> <p>Model No: <a href="#">PE9419</a></p>	PRICE	1-9	\$251.02	10-24	\$238.47	25-49	\$225.92	50+	\$215.88	<p><b>LC Between Series</b></p> <p>→</p>																		
PRICE																																																		
1-9	\$302.54																																																	
10-24	\$287.41																																																	
25-49	\$272.29																																																	
50+	\$260.18																																																	
PRICE																																																		
1-9	\$402.08																																																	
10-24	\$381.98																																																	
25-49	\$361.87																																																	
50+	\$345.79																																																	
PRICE																																																		
1-9	\$251.02																																																	
10-24	\$238.47																																																	
25-49	\$225.92																																																	
50+	\$215.88																																																	
5	 <table border="1"> <thead> <tr><th>PRICE</th></tr> </thead> <tbody> <tr><td>1-9</td><td>\$305.24</td></tr> <tr><td>10-24</td><td>\$289.98</td></tr> <tr><td>25-49</td><td>\$274.72</td></tr> <tr><td>50+</td><td>\$262.51</td></tr> </tbody> </table> <p>LC Male to HN Female</p> <p>Model No: <a href="#">PE9181</a></p>	PRICE	1-9	\$305.24	10-24	\$289.98	25-49	\$274.72	50+	\$262.51	 <table border="1"> <thead> <tr><th>PRICE</th></tr> </thead> <tbody> <tr><td>1-9</td><td>\$271.99</td></tr> <tr><td>10-24</td><td>\$258.39</td></tr> <tr><td>25-49</td><td>\$244.79</td></tr> <tr><td>50+</td><td>\$233.91</td></tr> </tbody> </table> <p>LC Female to HN Male</p> <p>Model No: <a href="#">PE9413</a></p>	PRICE	1-9	\$271.99	10-24	\$258.39	25-49	\$244.79	50+	\$233.91	<p><b>MCX In-Series</b></p> <p>→</p>	 <table border="1"> <thead> <tr><th>PRICE</th></tr> </thead> <tbody> <tr><td>1-24</td><td>\$71.18</td></tr> <tr><td>25-49</td><td>\$67.62</td></tr> <tr><td>50-99</td><td>\$64.06</td></tr> <tr><td>100+</td><td>\$61.21</td></tr> </tbody> </table> <p>MCX Plug to MCX Jack VSWR 1.35:1 to 6 GHz</p> <p>Model No: <a href="#">PE9479</a></p>	PRICE	1-24	\$71.18	25-49	\$67.62	50-99	\$64.06	100+	\$61.21	 <table border="1"> <thead> <tr><th>PRICE</th></tr> </thead> <tbody> <tr><td>1-24</td><td>\$21.23</td></tr> <tr><td>25-49</td><td>\$20.17</td></tr> <tr><td>50-99</td><td>\$19.11</td></tr> <tr><td>100+</td><td>\$18.26</td></tr> </tbody> </table> <p>MCX Jack to MCX Jack</p> <p>Model No: <a href="#">PE9524</a></p>	PRICE	1-24	\$21.23	25-49	\$20.17	50-99	\$19.11	100+	\$18.26									
PRICE																																																		
1-9	\$305.24																																																	
10-24	\$289.98																																																	
25-49	\$274.72																																																	
50+	\$262.51																																																	
PRICE																																																		
1-9	\$271.99																																																	
10-24	\$258.39																																																	
25-49	\$244.79																																																	
50+	\$233.91																																																	
PRICE																																																		
1-24	\$71.18																																																	
25-49	\$67.62																																																	
50-99	\$64.06																																																	
100+	\$61.21																																																	
PRICE																																																		
1-24	\$21.23																																																	
25-49	\$20.17																																																	
50-99	\$19.11																																																	
100+	\$18.26																																																	
6	 <table border="1"> <thead> <tr><th>PRICE</th></tr> </thead> <tbody> <tr><td>1-24</td><td>\$27.27</td></tr> <tr><td>25-49</td><td>\$25.91</td></tr> <tr><td>50-99</td><td>\$24.54</td></tr> <tr><td>100+</td><td>\$23.45</td></tr> </tbody> </table> <p>MCX Jack to MCX Jack Bulkhead VSWR 1.35:1 to 3 GHz</p> <p>Model No: <a href="#">PE9474</a></p>	PRICE	1-24	\$27.27	25-49	\$25.91	50-99	\$24.54	100+	\$23.45	<p><b>MCX Between Series</b></p> <p>→</p>	 <table border="1"> <thead> <tr><th>PRICE</th></tr> </thead> <tbody> <tr><td>1-24</td><td>\$96.89</td></tr> <tr><td>25-49</td><td>\$92.05</td></tr> <tr><td>50-99</td><td>\$87.20</td></tr> <tr><td>100+</td><td>\$83.33</td></tr> </tbody> </table> <p>MCX Plug to BNC Male</p> <p>Model No: <a href="#">PE9469</a></p>	PRICE	1-24	\$96.89	25-49	\$92.05	50-99	\$87.20	100+	\$83.33	 <table border="1"> <thead> <tr><th>PRICE</th></tr> </thead> <tbody> <tr><td>1-24</td><td>\$81.81</td></tr> <tr><td>25-49</td><td>\$77.72</td></tr> <tr><td>50-99</td><td>\$73.63</td></tr> <tr><td>100+</td><td>\$70.36</td></tr> </tbody> </table> <p>MCX Plug to BNC Female</p> <p>Model No: <a href="#">PE9467</a></p>	PRICE	1-24	\$81.81	25-49	\$77.72	50-99	\$73.63	100+	\$70.36	 <table border="1"> <thead> <tr><th>PRICE</th></tr> </thead> <tbody> <tr><td>1-24</td><td>\$76.11</td></tr> <tr><td>25-49</td><td>\$72.30</td></tr> <tr><td>50-99</td><td>\$68.50</td></tr> <tr><td>100+</td><td>\$65.45</td></tr> </tbody> </table> <p>MCX Jack to BNC Male</p> <p>Model No: <a href="#">PE9468</a></p>	PRICE	1-24	\$76.11	25-49	\$72.30	50-99	\$68.50	100+	\$65.45									
PRICE																																																		
1-24	\$27.27																																																	
25-49	\$25.91																																																	
50-99	\$24.54																																																	
100+	\$23.45																																																	
PRICE																																																		
1-24	\$96.89																																																	
25-49	\$92.05																																																	
50-99	\$87.20																																																	
100+	\$83.33																																																	
PRICE																																																		
1-24	\$81.81																																																	
25-49	\$77.72																																																	
50-99	\$73.63																																																	
100+	\$70.36																																																	
PRICE																																																		
1-24	\$76.11																																																	
25-49	\$72.30																																																	
50-99	\$68.50																																																	
100+	\$65.45																																																	
7	 <table border="1"> <thead> <tr><th>PRICE</th></tr> </thead> <tbody> <tr><td>1-24</td><td>\$97.55</td></tr> <tr><td>25-49</td><td>\$92.67</td></tr> <tr><td>50-99</td><td>\$87.80</td></tr> <tr><td>100+</td><td>\$83.89</td></tr> </tbody> </table> <p>MCX Jack to BNC Female</p> <p>Model No: <a href="#">PE9466</a></p>	PRICE	1-24	\$97.55	25-49	\$92.67	50-99	\$87.80	100+	\$83.89	 <table border="1"> <thead> <tr><th>PRICE</th></tr> </thead> <tbody> <tr><td>1-24</td><td>\$97.80</td></tr> <tr><td>25-49</td><td>\$92.91</td></tr> <tr><td>50-99</td><td>\$88.02</td></tr> <tr><td>100+</td><td>\$84.11</td></tr> </tbody> </table> <p>MCX Jack to BNC Female Bulkhead-Mounting Hole B04</p> <p>Model No: <a href="#">PE9520</a></p>	PRICE	1-24	\$97.80	25-49	\$92.91	50-99	\$88.02	100+	\$84.11	<p><b>MHV In-Series</b></p> <p>→</p>	 <table border="1"> <thead> <tr><th>PRICE</th></tr> </thead> <tbody> <tr><td>1-24</td><td>\$44.40</td></tr> <tr><td>25-49</td><td>\$42.18</td></tr> <tr><td>50-99</td><td>\$39.96</td></tr> <tr><td>100+</td><td>\$38.18</td></tr> </tbody> </table> <p>MHV Male to BNC Female VSWR 1.3:1 to 300 MHz</p> <p>Model No: <a href="#">PE9297</a></p>	PRICE	1-24	\$44.40	25-49	\$42.18	50-99	\$39.96	100+	\$38.18	 <table border="1"> <thead> <tr><th>PRICE</th></tr> </thead> <tbody> <tr><td>1-24</td><td>\$59.73</td></tr> <tr><td>25-49</td><td>\$56.74</td></tr> <tr><td>50-99</td><td>\$53.76</td></tr> <tr><td>100+</td><td>\$51.37</td></tr> </tbody> </table> <p>MHV Male to MHV Female Right Angle Max. Freq. 50 MHz</p> <p>Model No: <a href="#">PE9266</a></p>	PRICE	1-24	\$59.73	25-49	\$56.74	50-99	\$53.76	100+	\$51.37									
PRICE																																																		
1-24	\$97.55																																																	
25-49	\$92.67																																																	
50-99	\$87.80																																																	
100+	\$83.89																																																	
PRICE																																																		
1-24	\$97.80																																																	
25-49	\$92.91																																																	
50-99	\$88.02																																																	
100+	\$84.11																																																	
PRICE																																																		
1-24	\$44.40																																																	
25-49	\$42.18																																																	
50-99	\$39.96																																																	
100+	\$38.18																																																	
PRICE																																																		
1-24	\$59.73																																																	
25-49	\$56.74																																																	
50-99	\$53.76																																																	
100+	\$51.37																																																	



Technical Support  
+1 (949) 261-1920



Same-Day Shipping,  
Even Custom Cable Assemblies

# ADAPTERS

See Adapter Locator on Pages 8-13

See Page 369 for Mounting Holes

Adapters

See Our Website For Current Pricing & Real-Time Stock Availability!

	A	B	C	D	E																																																		
1	 <table border="1"> <thead> <tr> <th colspan="2">PRICE</th> </tr> </thead> <tbody> <tr> <td>1-24</td> <td>\$54.83</td> </tr> <tr> <td>25-49</td> <td>\$52.09</td> </tr> <tr> <td>50-99</td> <td>\$49.35</td> </tr> <tr> <td>100+</td> <td>\$47.15</td> </tr> </tbody> </table> <p>MHV Female to MHV Male Tee Max. Freq. 50 MHz Model No: <a href="#">PE9211</a></p>	PRICE		1-24	\$54.83	25-49	\$52.09	50-99	\$49.35	100+	\$47.15	 <table border="1"> <thead> <tr> <th colspan="2">PRICE</th> </tr> </thead> <tbody> <tr> <td>1-24</td> <td>\$36.26</td> </tr> <tr> <td>25-49</td> <td>\$34.45</td> </tr> <tr> <td>50-99</td> <td>\$32.63</td> </tr> <tr> <td>100+</td> <td>\$31.18</td> </tr> </tbody> </table> <p>MHV Female to MHV Female VSWR 1.3:1 to 300 MHz Model No: <a href="#">PE9267</a></p>	PRICE		1-24	\$36.26	25-49	\$34.45	50-99	\$32.63	100+	\$31.18	 <table border="1"> <thead> <tr> <th colspan="2">PRICE</th> </tr> </thead> <tbody> <tr> <td>1-24</td> <td>\$61.77</td> </tr> <tr> <td>25-49</td> <td>\$58.68</td> </tr> <tr> <td>50-99</td> <td>\$55.59</td> </tr> <tr> <td>100+</td> <td>\$53.12</td> </tr> </tbody> </table> <p>MHV Female to MHV Female Bulkhead Model No: <a href="#">PE9268</a></p>	PRICE		1-24	\$61.77	25-49	\$58.68	50-99	\$55.59	100+	\$53.12	<p style="text-align: center;"><b>MHV Between Series</b></p> <p style="text-align: center;">→</p>	 <table border="1"> <thead> <tr> <th colspan="2">PRICE</th> </tr> </thead> <tbody> <tr> <td>1-24</td> <td>\$103.78</td> </tr> <tr> <td>25-49</td> <td>\$98.59</td> </tr> <tr> <td>50-99</td> <td>\$93.40</td> </tr> <tr> <td>100+</td> <td>\$89.25</td> </tr> </tbody> </table> <p>MHV Male to SHV Plug Model No: <a href="#">PE9340</a></p>	PRICE		1-24	\$103.78	25-49	\$98.59	50-99	\$93.40	100+	\$89.25										
	PRICE																																																						
1-24	\$54.83																																																						
25-49	\$52.09																																																						
50-99	\$49.35																																																						
100+	\$47.15																																																						
PRICE																																																							
1-24	\$36.26																																																						
25-49	\$34.45																																																						
50-99	\$32.63																																																						
100+	\$31.18																																																						
PRICE																																																							
1-24	\$61.77																																																						
25-49	\$58.68																																																						
50-99	\$55.59																																																						
100+	\$53.12																																																						
PRICE																																																							
1-24	\$103.78																																																						
25-49	\$98.59																																																						
50-99	\$93.40																																																						
100+	\$89.25																																																						
2	 <table border="1"> <thead> <tr> <th colspan="2">PRICE</th> </tr> </thead> <tbody> <tr> <td>1-9</td> <td>\$125.48</td> </tr> <tr> <td>10-24</td> <td>\$119.21</td> </tr> <tr> <td>25-49</td> <td>\$112.93</td> </tr> <tr> <td>50+</td> <td>\$107.91</td> </tr> </tbody> </table> <p>MHV Male to SHV Jack Model No: <a href="#">PE9335</a></p>	PRICE		1-9	\$125.48	10-24	\$119.21	25-49	\$112.93	50+	\$107.91	 <table border="1"> <thead> <tr> <th colspan="2">PRICE</th> </tr> </thead> <tbody> <tr> <td>1-9</td> <td>\$114.61</td> </tr> <tr> <td>10-24</td> <td>\$108.88</td> </tr> <tr> <td>25-49</td> <td>\$103.15</td> </tr> <tr> <td>50+</td> <td>\$98.56</td> </tr> </tbody> </table> <p>MHV Female to SHV Plug Model No: <a href="#">PE9265</a></p>	PRICE		1-9	\$114.61	10-24	\$108.88	25-49	\$103.15	50+	\$98.56	 <table border="1"> <thead> <tr> <th colspan="2">PRICE</th> </tr> </thead> <tbody> <tr> <td>1-24</td> <td>\$67.60</td> </tr> <tr> <td>25-49</td> <td>\$64.22</td> </tr> <tr> <td>50-99</td> <td>\$60.84</td> </tr> <tr> <td>100+</td> <td>\$58.14</td> </tr> </tbody> </table> <p>MHV Female to SHV Jack Model No: <a href="#">PE9339</a></p>	PRICE		1-24	\$67.60	25-49	\$64.22	50-99	\$60.84	100+	\$58.14	<p style="text-align: center;"><b>Mini SMP In-Series</b></p> <p style="text-align: center;">→</p>	 <table border="1"> <thead> <tr> <th colspan="2">PRICE</th> </tr> </thead> <tbody> <tr> <td>1-24</td> <td>\$50.20</td> </tr> <tr> <td>25-49</td> <td>\$47.69</td> </tr> <tr> <td>50-99</td> <td>\$45.18</td> </tr> <tr> <td>100+</td> <td>\$43.17</td> </tr> </tbody> </table> <p>Mini SMP Female to Mini SMP Female Max. Freq. 65 GHz Model No: <a href="#">PE9780</a></p>	PRICE		1-24	\$50.20	25-49	\$47.69	50-99	\$45.18	100+	\$43.17										
	PRICE																																																						
1-9	\$125.48																																																						
10-24	\$119.21																																																						
25-49	\$112.93																																																						
50+	\$107.91																																																						
PRICE																																																							
1-9	\$114.61																																																						
10-24	\$108.88																																																						
25-49	\$103.15																																																						
50+	\$98.56																																																						
PRICE																																																							
1-24	\$67.60																																																						
25-49	\$64.22																																																						
50-99	\$60.84																																																						
100+	\$58.14																																																						
PRICE																																																							
1-24	\$50.20																																																						
25-49	\$47.69																																																						
50-99	\$45.18																																																						
100+	\$43.17																																																						
3	 <table border="1"> <thead> <tr> <th colspan="2">PRICE</th> </tr> </thead> <tbody> <tr> <td>1-24</td> <td>\$28.42</td> </tr> <tr> <td>25-49</td> <td>\$27.00</td> </tr> <tr> <td>50-99</td> <td>\$25.58</td> </tr> <tr> <td>100+</td> <td>\$24.44</td> </tr> </tbody> </table> <p>Mini SMP Female to Mini SMP Female VSWR 1.2:1 to 26.5 GHz Model No: <a href="#">PE91069</a></p>	PRICE		1-24	\$28.42	25-49	\$27.00	50-99	\$25.58	100+	\$24.44	<p style="text-align: center;"><b>Mini UHF In-Series</b></p> <p style="text-align: center;">→</p>	 <table border="1"> <thead> <tr> <th colspan="2">PRICE</th> </tr> </thead> <tbody> <tr> <td>1-24</td> <td>\$16.58</td> </tr> <tr> <td>25-49</td> <td>\$15.75</td> </tr> <tr> <td>50-99</td> <td>\$14.92</td> </tr> <tr> <td>100+</td> <td>\$14.26</td> </tr> </tbody> </table> <p>Mini UHF Male to Mini UHF Female Right Angle Model No: <a href="#">PE9347</a></p>	PRICE		1-24	\$16.58	25-49	\$15.75	50-99	\$14.92	100+	\$14.26	 <table border="1"> <thead> <tr> <th colspan="2">PRICE</th> </tr> </thead> <tbody> <tr> <td>1-24</td> <td>\$9.84</td> </tr> <tr> <td>25-49</td> <td>\$9.35</td> </tr> <tr> <td>50-99</td> <td>\$8.86</td> </tr> <tr> <td>100+</td> <td>\$8.46</td> </tr> </tbody> </table> <p>Mini UHF Female to Mini UHF Male Tee Model No: <a href="#">PE9065</a></p>	PRICE		1-24	\$9.84	25-49	\$9.35	50-99	\$8.86	100+	\$8.46	 <table border="1"> <thead> <tr> <th colspan="2">PRICE</th> </tr> </thead> <tbody> <tr> <td>1-24</td> <td>\$18.56</td> </tr> <tr> <td>25-49</td> <td>\$17.63</td> </tr> <tr> <td>50-99</td> <td>\$16.70</td> </tr> <tr> <td>100+</td> <td>\$15.96</td> </tr> </tbody> </table> <p>Mini UHF Female to Mini UHF Female Model No: <a href="#">PE9343</a></p>	PRICE		1-24	\$18.56	25-49	\$17.63	50-99	\$16.70	100+	\$15.96										
	PRICE																																																						
1-24	\$28.42																																																						
25-49	\$27.00																																																						
50-99	\$25.58																																																						
100+	\$24.44																																																						
PRICE																																																							
1-24	\$16.58																																																						
25-49	\$15.75																																																						
50-99	\$14.92																																																						
100+	\$14.26																																																						
PRICE																																																							
1-24	\$9.84																																																						
25-49	\$9.35																																																						
50-99	\$8.86																																																						
100+	\$8.46																																																						
PRICE																																																							
1-24	\$18.56																																																						
25-49	\$17.63																																																						
50-99	\$16.70																																																						
100+	\$15.96																																																						
4	 <table border="1"> <thead> <tr> <th colspan="2">PRICE</th> </tr> </thead> <tbody> <tr> <td>1-24</td> <td>\$17.35</td> </tr> <tr> <td>25-49</td> <td>\$16.48</td> </tr> <tr> <td>50-99</td> <td>\$15.62</td> </tr> <tr> <td>100+</td> <td>\$14.92</td> </tr> </tbody> </table> <p>Mini UHF Female to Mini UHF Female Tee Model No: <a href="#">PE9066</a></p>	PRICE		1-24	\$17.35	25-49	\$16.48	50-99	\$15.62	100+	\$14.92	<p style="text-align: center;"><b>Mini UHF Between Series</b></p> <p style="text-align: center;">→</p>	 <table border="1"> <thead> <tr> <th colspan="2">PRICE</th> </tr> </thead> <tbody> <tr> <td>1-24</td> <td>\$17.69</td> </tr> <tr> <td>25-49</td> <td>\$16.81</td> </tr> <tr> <td>50-99</td> <td>\$15.92</td> </tr> <tr> <td>100+</td> <td>\$15.21</td> </tr> </tbody> </table> <p>Mini UHF Male to BNC Female Model No: <a href="#">PE9342</a></p>	PRICE		1-24	\$17.69	25-49	\$16.81	50-99	\$15.92	100+	\$15.21	 <table border="1"> <thead> <tr> <th colspan="2">PRICE</th> </tr> </thead> <tbody> <tr> <td>1-24</td> <td>\$16.99</td> </tr> <tr> <td>25-49</td> <td>\$16.14</td> </tr> <tr> <td>50-99</td> <td>\$15.29</td> </tr> <tr> <td>100+</td> <td>\$14.61</td> </tr> </tbody> </table> <p>Mini UHF Male to FME Plug Model No: <a href="#">PE9705</a></p>	PRICE		1-24	\$16.99	25-49	\$16.14	50-99	\$15.29	100+	\$14.61	 <table border="1"> <thead> <tr> <th colspan="2">PRICE</th> </tr> </thead> <tbody> <tr> <td>1-24</td> <td>\$16.23</td> </tr> <tr> <td>25-49</td> <td>\$15.42</td> </tr> <tr> <td>50-99</td> <td>\$14.61</td> </tr> <tr> <td>100+</td> <td>\$13.96</td> </tr> </tbody> </table> <p>Mini UHF Male to FME Plug Right Angle Model No: <a href="#">PE9706</a></p>	PRICE		1-24	\$16.23	25-49	\$15.42	50-99	\$14.61	100+	\$13.96										
	PRICE																																																						
1-24	\$17.35																																																						
25-49	\$16.48																																																						
50-99	\$15.62																																																						
100+	\$14.92																																																						
PRICE																																																							
1-24	\$17.69																																																						
25-49	\$16.81																																																						
50-99	\$15.92																																																						
100+	\$15.21																																																						
PRICE																																																							
1-24	\$16.99																																																						
25-49	\$16.14																																																						
50-99	\$15.29																																																						
100+	\$14.61																																																						
PRICE																																																							
1-24	\$16.23																																																						
25-49	\$15.42																																																						
50-99	\$14.61																																																						
100+	\$13.96																																																						
5	 <table border="1"> <thead> <tr> <th colspan="2">PRICE</th> </tr> </thead> <tbody> <tr> <td>1-24</td> <td>\$14.03</td> </tr> <tr> <td>25-49</td> <td>\$13.33</td> </tr> <tr> <td>50-99</td> <td>\$12.63</td> </tr> <tr> <td>100+</td> <td>\$12.07</td> </tr> </tbody> </table> <p>Mini UHF Male to FME Jack Model No: <a href="#">PE9709</a></p>	PRICE		1-24	\$14.03	25-49	\$13.33	50-99	\$12.63	100+	\$12.07	 <table border="1"> <thead> <tr> <th colspan="2">PRICE</th> </tr> </thead> <tbody> <tr> <td>1-24</td> <td>\$19.18</td> </tr> <tr> <td>25-49</td> <td>\$18.22</td> </tr> <tr> <td>50-99</td> <td>\$17.26</td> </tr> <tr> <td>100+</td> <td>\$16.49</td> </tr> </tbody> </table> <p>Mini UHF Female to BNC Male Model No: <a href="#">PE9341</a></p>	PRICE		1-24	\$19.18	25-49	\$18.22	50-99	\$17.26	100+	\$16.49	 <table border="1"> <thead> <tr> <th colspan="2">PRICE</th> </tr> </thead> <tbody> <tr> <td>1-24</td> <td>\$14.86</td> </tr> <tr> <td>25-49</td> <td>\$14.12</td> </tr> <tr> <td>50-99</td> <td>\$13.37</td> </tr> <tr> <td>100+</td> <td>\$12.78</td> </tr> </tbody> </table> <p>Mini UHF Female to FME Jack Model No: <a href="#">PE9710</a></p>	PRICE		1-24	\$14.86	25-49	\$14.12	50-99	\$13.37	100+	\$12.78	<p style="text-align: center;"><b>MMCX In-Series</b></p> <p style="text-align: center;">→</p>	 <table border="1"> <thead> <tr> <th colspan="2">PRICE</th> </tr> </thead> <tbody> <tr> <td>1-24</td> <td>\$84.62</td> </tr> <tr> <td>25-49</td> <td>\$80.39</td> </tr> <tr> <td>50-99</td> <td>\$76.16</td> </tr> <tr> <td>100+</td> <td>\$72.77</td> </tr> </tbody> </table> <p>MMCX Plug to MMCX Jack Model No: <a href="#">PE9480</a></p>	PRICE		1-24	\$84.62	25-49	\$80.39	50-99	\$76.16	100+	\$72.77										
	PRICE																																																						
1-24	\$14.03																																																						
25-49	\$13.33																																																						
50-99	\$12.63																																																						
100+	\$12.07																																																						
PRICE																																																							
1-24	\$19.18																																																						
25-49	\$18.22																																																						
50-99	\$17.26																																																						
100+	\$16.49																																																						
PRICE																																																							
1-24	\$14.86																																																						
25-49	\$14.12																																																						
50-99	\$13.37																																																						
100+	\$12.78																																																						
PRICE																																																							
1-24	\$84.62																																																						
25-49	\$80.39																																																						
50-99	\$76.16																																																						
100+	\$72.77																																																						
6	 <table border="1"> <thead> <tr> <th colspan="2">PRICE</th> </tr> </thead> <tbody> <tr> <td>1-24</td> <td>\$73.01</td> </tr> <tr> <td>25-49</td> <td>\$69.36</td> </tr> <tr> <td>50-99</td> <td>\$65.71</td> </tr> <tr> <td>100+</td> <td>\$62.79</td> </tr> </tbody> </table> <p>MMCX Jack to MMCX Jack Model No: <a href="#">PE9523</a></p>	PRICE		1-24	\$73.01	25-49	\$69.36	50-99	\$65.71	100+	\$62.79	 <table border="1"> <thead> <tr> <th colspan="2">PRICE</th> </tr> </thead> <tbody> <tr> <td>1-24</td> <td>\$65.41</td> </tr> <tr> <td>25-49</td> <td>\$62.14</td> </tr> <tr> <td>50-99</td> <td>\$58.87</td> </tr> <tr> <td>100+</td> <td>\$56.25</td> </tr> </tbody> </table> <p>MMCX Jack to MMCX Jack Bulkhead-Mounting Hole B01 Model No: <a href="#">PE9522</a></p>	PRICE		1-24	\$65.41	25-49	\$62.14	50-99	\$58.87	100+	\$56.25	<p style="text-align: center;"><b>MMCX Between Series</b></p> <p style="text-align: center;">→</p>	 <table border="1"> <thead> <tr> <th colspan="2">PRICE</th> </tr> </thead> <tbody> <tr> <td>1-9</td> <td>\$112.21</td> </tr> <tr> <td>10-24</td> <td>\$106.60</td> </tr> <tr> <td>25-49</td> <td>\$100.99</td> </tr> <tr> <td>50+</td> <td>\$96.50</td> </tr> </tbody> </table> <p>MMCX Plug to BNC Male Model No: <a href="#">PE9517</a></p>	PRICE		1-9	\$112.21	10-24	\$106.60	25-49	\$100.99	50+	\$96.50	 <table border="1"> <thead> <tr> <th colspan="2">PRICE</th> </tr> </thead> <tbody> <tr> <td>1-9</td> <td>\$123.53</td> </tr> <tr> <td>10-24</td> <td>\$117.35</td> </tr> <tr> <td>25-49</td> <td>\$111.18</td> </tr> <tr> <td>50+</td> <td>\$106.24</td> </tr> </tbody> </table> <p>MMCX Plug to BNC Female Model No: <a href="#">PE9519</a></p>	PRICE		1-9	\$123.53	10-24	\$117.35	25-49	\$111.18	50+	\$106.24										
	PRICE																																																						
1-24	\$73.01																																																						
25-49	\$69.36																																																						
50-99	\$65.71																																																						
100+	\$62.79																																																						
PRICE																																																							
1-24	\$65.41																																																						
25-49	\$62.14																																																						
50-99	\$58.87																																																						
100+	\$56.25																																																						
PRICE																																																							
1-9	\$112.21																																																						
10-24	\$106.60																																																						
25-49	\$100.99																																																						
50+	\$96.50																																																						
PRICE																																																							
1-9	\$123.53																																																						
10-24	\$117.35																																																						
25-49	\$111.18																																																						
50+	\$106.24																																																						
7	 <table border="1"> <thead> <tr> <th colspan="2">PRICE</th> </tr> </thead> <tbody> <tr> <td>1-24</td> <td>\$96.42</td> </tr> <tr> <td>25-49</td> <td>\$91.60</td> </tr> <tr> <td>50-99</td> <td>\$86.78</td> </tr> <tr> <td>100+</td> <td>\$82.92</td> </tr> </tbody> </table> <p>MMCX Plug to MCX Plug Model No: <a href="#">PE9527</a></p>	PRICE		1-24	\$96.42	25-49	\$91.60	50-99	\$86.78	100+	\$82.92	 <table border="1"> <thead> <tr> <th colspan="2">PRICE</th> </tr> </thead> <tbody> <tr> <td>1-24</td> <td>\$116.30</td> </tr> <tr> <td>25-49</td> <td>\$110.49</td> </tr> <tr> <td>50-99</td> <td>\$104.67</td> </tr> <tr> <td>100+</td> <td>\$100.02</td> </tr> </tbody> </table> <p>MMCX Plug to MCX Jack Model No: <a href="#">PE9525</a></p>	PRICE		1-24	\$116.30	25-49	\$110.49	50-99	\$104.67	100+	\$100.02	 <table border="1"> <thead> <tr> <th colspan="2">PRICE</th> </tr> </thead> <tbody> <tr> <td>1-24</td> <td>\$89.43</td> </tr> <tr> <td>25-49</td> <td>\$84.96</td> </tr> <tr> <td>50-99</td> <td>\$80.49</td> </tr> <tr> <td>100+</td> <td>\$76.91</td> </tr> </tbody> </table> <p>MMCX Jack to BNC Male Model No: <a href="#">PE9518</a></p>	PRICE		1-24	\$89.43	25-49	\$84.96	50-99	\$80.49	100+	\$76.91	 <table border="1"> <thead> <tr> <th colspan="2">PRICE</th> </tr> </thead> <tbody> <tr> <td>1-24</td> <td>\$94.92</td> </tr> <tr> <td>25-49</td> <td>\$90.17</td> </tr> <tr> <td>50-99</td> <td>\$85.43</td> </tr> <tr> <td>100+</td> <td>\$81.63</td> </tr> </tbody> </table> <p>MMCX Jack to BNC Female Model No: <a href="#">PE9516</a></p>	PRICE		1-24	\$94.92	25-49	\$90.17	50-99	\$85.43	100+	\$81.63	 <table border="1"> <thead> <tr> <th colspan="2">PRICE</th> </tr> </thead> <tbody> <tr> <td>1-24</td> <td>\$115.70</td> </tr> <tr> <td>25-49</td> <td>\$109.92</td> </tr> <tr> <td>50-99</td> <td>\$104.13</td> </tr> <tr> <td>100+</td> <td>\$99.50</td> </tr> </tbody> </table> <p>MMCX Jack to MCX Plug Model No: <a href="#">PE9528</a></p>	PRICE		1-24	\$115.70	25-49	\$109.92	50-99	\$104.13	100+	\$99.50
	PRICE																																																						
1-24	\$96.42																																																						
25-49	\$91.60																																																						
50-99	\$86.78																																																						
100+	\$82.92																																																						
PRICE																																																							
1-24	\$116.30																																																						
25-49	\$110.49																																																						
50-99	\$104.67																																																						
100+	\$100.02																																																						
PRICE																																																							
1-24	\$89.43																																																						
25-49	\$84.96																																																						
50-99	\$80.49																																																						
100+	\$76.91																																																						
PRICE																																																							
1-24	\$94.92																																																						
25-49	\$90.17																																																						
50-99	\$85.43																																																						
100+	\$81.63																																																						
PRICE																																																							
1-24	\$115.70																																																						
25-49	\$109.92																																																						
50-99	\$104.13																																																						
100+	\$99.50																																																						

# ADAPTERS

See Adapter Locator on Pages 8-13

See Page 369 for Mounting Holes

	A	B	C	D	E																									
1	 <table border="1"> <thead> <tr> <th>PRICE</th> </tr> </thead> <tbody> <tr> <td>1-24 \$106.72</td> </tr> <tr> <td>25-49 \$101.38</td> </tr> <tr> <td>50-99 \$96.05</td> </tr> <tr> <td>100+ \$91.78</td> </tr> </tbody> </table> <p>MMCX Jack to MCX Jack</p> <p>Model No: <a href="#">PE9526</a></p>	PRICE	1-24 \$106.72	25-49 \$101.38	50-99 \$96.05	100+ \$91.78	<p><b>MMBX In-Series</b></p> <p>→</p>	 <table border="1"> <thead> <tr> <th>PRICE</th> </tr> </thead> <tbody> <tr> <td>1-24 \$11.48</td> </tr> <tr> <td>25-49 \$10.91</td> </tr> <tr> <td>50-99 \$10.33</td> </tr> <tr> <td>100+ \$9.87</td> </tr> </tbody> </table> <p>Slide-On MMBX Plug to Snap-On MMBX Plug</p> <p>VSWR 1.08:1 to 12.4 GHz</p> <p>Model No: <a href="#">PE91370</a></p>	PRICE	1-24 \$11.48	25-49 \$10.91	50-99 \$10.33	100+ \$9.87	 <table border="1"> <thead> <tr> <th>PRICE</th> </tr> </thead> <tbody> <tr> <td>1-24 \$13.26</td> </tr> <tr> <td>25-49 \$12.60</td> </tr> <tr> <td>50-99 \$11.93</td> </tr> <tr> <td>100+ \$11.40</td> </tr> </tbody> </table> <p>Slide-On MMBX Plug to Snap-On MMBX Plug</p> <p>VSWR 1.08:1 to 12.4 GHz</p> <p>Model No: <a href="#">PE91373</a></p>	PRICE	1-24 \$13.26	25-49 \$12.60	50-99 \$11.93	100+ \$11.40	 <table border="1"> <thead> <tr> <th>PRICE</th> </tr> </thead> <tbody> <tr> <td>1-24 \$14.38</td> </tr> <tr> <td>25-49 \$13.66</td> </tr> <tr> <td>50-99 \$12.94</td> </tr> <tr> <td>100+ \$12.37</td> </tr> </tbody> </table> <p>Slide-On MMBX Plug to Slide-On MMBX Plug</p> <p>VSWR 1.15:1 to 12.4 GHz</p> <p>Model No: <a href="#">PE91371</a></p>	PRICE	1-24 \$14.38	25-49 \$13.66	50-99 \$12.94	100+ \$12.37					
	PRICE																													
1-24 \$106.72																														
25-49 \$101.38																														
50-99 \$96.05																														
100+ \$91.78																														
PRICE																														
1-24 \$11.48																														
25-49 \$10.91																														
50-99 \$10.33																														
100+ \$9.87																														
PRICE																														
1-24 \$13.26																														
25-49 \$12.60																														
50-99 \$11.93																														
100+ \$11.40																														
PRICE																														
1-24 \$14.38																														
25-49 \$13.66																														
50-99 \$12.94																														
100+ \$12.37																														
2	 <table border="1"> <thead> <tr> <th>PRICE</th> </tr> </thead> <tbody> <tr> <td>1-24 \$18.44</td> </tr> <tr> <td>25-49 \$17.52</td> </tr> <tr> <td>50-99 \$16.60</td> </tr> <tr> <td>100+ \$15.86</td> </tr> </tbody> </table> <p>Snap-On MMBX Plug to Slide-On MMBX Plug</p> <p>VSWR 1.25:1 to 12.4 GHz</p> <p>Model No: <a href="#">PE91372</a></p>	PRICE	1-24 \$18.44	25-49 \$17.52	50-99 \$16.60	100+ \$15.86	<p><b>N In-Series</b></p> <p>→</p>	 <table border="1"> <thead> <tr> <th>PRICE</th> </tr> </thead> <tbody> <tr> <td>1-24 \$58.19</td> </tr> <tr> <td>25-49 \$55.28</td> </tr> <tr> <td>50-99 \$52.37</td> </tr> <tr> <td>100+ \$50.04</td> </tr> </tbody> </table> <p>N Male to N Male</p> <p>VSWR 1.2:1 to 6 GHz</p> <p>Model No: <a href="#">PE91198</a></p>	PRICE	1-24 \$58.19	25-49 \$55.28	50-99 \$52.37	100+ \$50.04	 <table border="1"> <thead> <tr> <th>PRICE</th> </tr> </thead> <tbody> <tr> <td>1-24 \$43.28</td> </tr> <tr> <td>25-49 \$41.12</td> </tr> <tr> <td>50-99 \$38.95</td> </tr> <tr> <td>100+ \$37.22</td> </tr> </tbody> </table> <p>N Male to N Male</p> <p>VSWR 1.3:1 to 6 GHz</p> <p>Model No: <a href="#">PE91235</a></p>	PRICE	1-24 \$43.28	25-49 \$41.12	50-99 \$38.95	100+ \$37.22	 <table border="1"> <thead> <tr> <th>PRICE</th> </tr> </thead> <tbody> <tr> <td>1-24 \$20.14</td> </tr> <tr> <td>25-49 \$19.13</td> </tr> <tr> <td>50-99 \$18.13</td> </tr> <tr> <td>100+ \$17.32</td> </tr> </tbody> </table> <p>N Male to N Male</p> <p>VSWR 1.3:1 to 6 GHz</p> <p>Model No: <a href="#">PE9007</a></p>	PRICE	1-24 \$20.14	25-49 \$19.13	50-99 \$18.13	100+ \$17.32					
	PRICE																													
1-24 \$18.44																														
25-49 \$17.52																														
50-99 \$16.60																														
100+ \$15.86																														
PRICE																														
1-24 \$58.19																														
25-49 \$55.28																														
50-99 \$52.37																														
100+ \$50.04																														
PRICE																														
1-24 \$43.28																														
25-49 \$41.12																														
50-99 \$38.95																														
100+ \$37.22																														
PRICE																														
1-24 \$20.14																														
25-49 \$19.13																														
50-99 \$18.13																														
100+ \$17.32																														
3	 <table border="1"> <thead> <tr> <th>PRICE</th> </tr> </thead> <tbody> <tr> <td>1-24 \$94.34</td> </tr> <tr> <td>25-49 \$89.62</td> </tr> <tr> <td>50-99 \$84.91</td> </tr> <tr> <td>100+ \$81.13</td> </tr> </tbody> </table> <p>Low PIM</p> <p>N Male to N Male</p> <p>Max. Freq. 12.4 GHz</p> <p>Model No: <a href="#">PE91034</a></p>	PRICE	1-24 \$94.34	25-49 \$89.62	50-99 \$84.91	100+ \$81.13	 <table border="1"> <thead> <tr> <th>PRICE</th> </tr> </thead> <tbody> <tr> <td>1-24 \$39.91</td> </tr> <tr> <td>25-49 \$37.91</td> </tr> <tr> <td>50-99 \$35.92</td> </tr> <tr> <td>100+ \$34.32</td> </tr> </tbody> </table> <p>N Male to N Male Right Angle</p> <p>VSWR 1.5:1 to 11 GHz</p> <p>Model No: <a href="#">PE9198</a></p>	PRICE	1-24 \$39.91	25-49 \$37.91	50-99 \$35.92	100+ \$34.32	 <table border="1"> <thead> <tr> <th>PRICE</th> </tr> </thead> <tbody> <tr> <td>1-24 \$94.68</td> </tr> <tr> <td>25-49 \$89.95</td> </tr> <tr> <td>50-99 \$85.21</td> </tr> <tr> <td>100+ \$81.42</td> </tr> </tbody> </table> <p>N Male to N Male Tee</p> <p>Model No: <a href="#">PE9390</a></p>	PRICE	1-24 \$94.68	25-49 \$89.95	50-99 \$85.21	100+ \$81.42	 <table border="1"> <thead> <tr> <th>PRICE</th> </tr> </thead> <tbody> <tr> <td>1-24 \$58.19</td> </tr> <tr> <td>25-49 \$55.28</td> </tr> <tr> <td>50-99 \$52.37</td> </tr> <tr> <td>100+ \$50.04</td> </tr> </tbody> </table> <p>N Male to N Female</p> <p>VSWR 1.2:1 to 6 GHz</p> <p>Model No: <a href="#">PE91199</a></p>	PRICE	1-24 \$58.19	25-49 \$55.28	50-99 \$52.37	100+ \$50.04	 <table border="1"> <thead> <tr> <th>PRICE</th> </tr> </thead> <tbody> <tr> <td>1-24 \$41.30</td> </tr> <tr> <td>25-49 \$39.24</td> </tr> <tr> <td>50-99 \$37.17</td> </tr> <tr> <td>100+ \$35.52</td> </tr> </tbody> </table> <p>N Male to N Female</p> <p>VSWR 1.3:1 to 6 GHz</p> <p>Model No: <a href="#">PE91236</a></p>	PRICE	1-24 \$41.30	25-49 \$39.24	50-99 \$37.17	100+ \$35.52
	PRICE																													
1-24 \$94.34																														
25-49 \$89.62																														
50-99 \$84.91																														
100+ \$81.13																														
PRICE																														
1-24 \$39.91																														
25-49 \$37.91																														
50-99 \$35.92																														
100+ \$34.32																														
PRICE																														
1-24 \$94.68																														
25-49 \$89.95																														
50-99 \$85.21																														
100+ \$81.42																														
PRICE																														
1-24 \$58.19																														
25-49 \$55.28																														
50-99 \$52.37																														
100+ \$50.04																														
PRICE																														
1-24 \$41.30																														
25-49 \$39.24																														
50-99 \$37.17																														
100+ \$35.52																														
4	 <table border="1"> <thead> <tr> <th>PRICE</th> </tr> </thead> <tbody> <tr> <td>1-24 \$98.25</td> </tr> <tr> <td>25-49 \$93.34</td> </tr> <tr> <td>50-99 \$88.43</td> </tr> <tr> <td>100+ \$84.50</td> </tr> </tbody> </table> <p>Low PIM</p> <p>N Male to N Female</p> <p>Max. Freq. 12.4 GHz</p> <p>Model No: <a href="#">PE91040</a></p>	PRICE	1-24 \$98.25	25-49 \$93.34	50-99 \$88.43	100+ \$84.50	 <table border="1"> <thead> <tr> <th>PRICE</th> </tr> </thead> <tbody> <tr> <td>1-24 \$30.92</td> </tr> <tr> <td>25-49 \$29.37</td> </tr> <tr> <td>50-99 \$27.83</td> </tr> <tr> <td>100+ \$26.59</td> </tr> </tbody> </table> <p>Push-On N Male to N Female</p> <p>VSWR 1.22:1 to 18 GHz</p> <p>Model No: <a href="#">PE91114</a></p>	PRICE	1-24 \$30.92	25-49 \$29.37	50-99 \$27.83	100+ \$26.59	 <table border="1"> <thead> <tr> <th>PRICE</th> </tr> </thead> <tbody> <tr> <td>1-24 \$30.80</td> </tr> <tr> <td>25-49 \$29.26</td> </tr> <tr> <td>50-99 \$27.72</td> </tr> <tr> <td>100+ \$26.49</td> </tr> </tbody> </table> <p>N Male to N Female</p> <p>VSWR 1.3:1 to 11 GHz</p> <p>Model No: <a href="#">PE9311</a></p>	PRICE	1-24 \$30.80	25-49 \$29.26	50-99 \$27.72	100+ \$26.49	 <table border="1"> <thead> <tr> <th>PRICE</th> </tr> </thead> <tbody> <tr> <td>1-24 \$55.27</td> </tr> <tr> <td>25-49 \$52.51</td> </tr> <tr> <td>50-99 \$49.74</td> </tr> <tr> <td>100+ \$47.53</td> </tr> </tbody> </table> <p>N Male to 75 Ohm N Female</p> <p>Model No: <a href="#">PE9349</a></p>	PRICE	1-24 \$55.27	25-49 \$52.51	50-99 \$49.74	100+ \$47.53	 <table border="1"> <thead> <tr> <th>PRICE</th> </tr> </thead> <tbody> <tr> <td>1-9 \$180.09</td> </tr> <tr> <td>10-24 \$171.09</td> </tr> <tr> <td>25-49 \$162.08</td> </tr> <tr> <td>50+ \$154.88</td> </tr> </tbody> </table> <p>QD N Male to N Female</p> <p>Model No: <a href="#">PE9547</a></p>	PRICE	1-9 \$180.09	10-24 \$171.09	25-49 \$162.08	50+ \$154.88
	PRICE																													
1-24 \$98.25																														
25-49 \$93.34																														
50-99 \$88.43																														
100+ \$84.50																														
PRICE																														
1-24 \$30.92																														
25-49 \$29.37																														
50-99 \$27.83																														
100+ \$26.59																														
PRICE																														
1-24 \$30.80																														
25-49 \$29.26																														
50-99 \$27.72																														
100+ \$26.49																														
PRICE																														
1-24 \$55.27																														
25-49 \$52.51																														
50-99 \$49.74																														
100+ \$47.53																														
PRICE																														
1-9 \$180.09																														
10-24 \$171.09																														
25-49 \$162.08																														
50+ \$154.88																														
5	 <table border="1"> <thead> <tr> <th>PRICE</th> </tr> </thead> <tbody> <tr> <td>1-9 \$296.93</td> </tr> <tr> <td>10-24 \$285.05</td> </tr> <tr> <td>25-49 \$276.14</td> </tr> <tr> <td>50+ \$270.21</td> </tr> </tbody> </table> <p>PRECISION</p> <p>N Male to N Female Radius Right Angle</p> <p>VSWR 1.25:1 to 18 GHz</p> <p>Model No: <a href="#">PE91350</a></p>	PRICE	1-9 \$296.93	10-24 \$285.05	25-49 \$276.14	50+ \$270.21	 <table border="1"> <thead> <tr> <th>PRICE</th> </tr> </thead> <tbody> <tr> <td>1-24 \$22.13</td> </tr> <tr> <td>25-49 \$21.02</td> </tr> <tr> <td>50-99 \$19.92</td> </tr> <tr> <td>100+ \$19.03</td> </tr> </tbody> </table> <p>N Male to N Female Right Angle</p> <p>VSWR 1.3:1 to 11 GHz</p> <p>Model No: <a href="#">PE9086</a></p>	PRICE	1-24 \$22.13	25-49 \$21.02	50-99 \$19.92	100+ \$19.03	 <table border="1"> <thead> <tr> <th>PRICE</th> </tr> </thead> <tbody> <tr> <td>1-24 \$98.47</td> </tr> <tr> <td>25-49 \$93.55</td> </tr> <tr> <td>50-99 \$88.62</td> </tr> <tr> <td>100+ \$84.68</td> </tr> </tbody> </table> <p>N Male to N Female Tee</p> <p>Model No: <a href="#">PE9481</a></p>	PRICE	1-24 \$98.47	25-49 \$93.55	50-99 \$88.62	100+ \$84.68	 <table border="1"> <thead> <tr> <th>PRICE</th> </tr> </thead> <tbody> <tr> <td>1-24 \$44.95</td> </tr> <tr> <td>25-49 \$42.70</td> </tr> <tr> <td>50-99 \$40.46</td> </tr> <tr> <td>100+ \$38.66</td> </tr> </tbody> </table> <p>N Male to N Female Bulkhead</p> <p>VSWR 1.3:1 to 11 GHz</p> <p>Model No: <a href="#">PE9595</a></p>	PRICE	1-24 \$44.95	25-49 \$42.70	50-99 \$40.46	100+ \$38.66	 <table border="1"> <thead> <tr> <th>PRICE</th> </tr> </thead> <tbody> <tr> <td>1-24 \$47.38</td> </tr> <tr> <td>25-49 \$45.01</td> </tr> <tr> <td>50-99 \$42.64</td> </tr> <tr> <td>100+ \$40.75</td> </tr> </tbody> </table> <p>N Female to 75 Ohm N Male</p> <p>Max. Freq. 500 MHz</p> <p>Model No: <a href="#">PE9350</a></p>	PRICE	1-24 \$47.38	25-49 \$45.01	50-99 \$42.64	100+ \$40.75
	PRICE																													
1-9 \$296.93																														
10-24 \$285.05																														
25-49 \$276.14																														
50+ \$270.21																														
PRICE																														
1-24 \$22.13																														
25-49 \$21.02																														
50-99 \$19.92																														
100+ \$19.03																														
PRICE																														
1-24 \$98.47																														
25-49 \$93.55																														
50-99 \$88.62																														
100+ \$84.68																														
PRICE																														
1-24 \$44.95																														
25-49 \$42.70																														
50-99 \$40.46																														
100+ \$38.66																														
PRICE																														
1-24 \$47.38																														
25-49 \$45.01																														
50-99 \$42.64																														
100+ \$40.75																														
6	 <table border="1"> <thead> <tr> <th>PRICE</th> </tr> </thead> <tbody> <tr> <td>1-24 \$53.26</td> </tr> <tr> <td>25-49 \$50.60</td> </tr> <tr> <td>50-99 \$47.93</td> </tr> <tr> <td>100+ \$45.80</td> </tr> </tbody> </table> <p>N Female to N Male Tee</p> <p>Max. Freq. 11 GHz</p> <p>Model No: <a href="#">PE9102</a></p>	PRICE	1-24 \$53.26	25-49 \$50.60	50-99 \$47.93	100+ \$45.80	 <table border="1"> <thead> <tr> <th>PRICE</th> </tr> </thead> <tbody> <tr> <td>1-24 \$58.19</td> </tr> <tr> <td>25-49 \$55.28</td> </tr> <tr> <td>50-99 \$52.37</td> </tr> <tr> <td>100+ \$50.04</td> </tr> </tbody> </table> <p>N Female to N Female</p> <p>VSWR 1.2:1 to 6 GHz</p> <p>Model No: <a href="#">PE91200</a></p>	PRICE	1-24 \$58.19	25-49 \$55.28	50-99 \$52.37	100+ \$50.04	 <table border="1"> <thead> <tr> <th>PRICE</th> </tr> </thead> <tbody> <tr> <td>1-24 \$37.49</td> </tr> <tr> <td>25-49 \$35.62</td> </tr> <tr> <td>50-99 \$33.74</td> </tr> <tr> <td>100+ \$32.24</td> </tr> </tbody> </table> <p>N Female to N Female</p> <p>VSWR 1.3:1 to 6 GHz</p> <p>Model No: <a href="#">PE91237</a></p>	PRICE	1-24 \$37.49	25-49 \$35.62	50-99 \$33.74	100+ \$32.24	 <table border="1"> <thead> <tr> <th>PRICE</th> </tr> </thead> <tbody> <tr> <td>1-24 \$17.85</td> </tr> <tr> <td>25-49 \$16.96</td> </tr> <tr> <td>50-99 \$16.07</td> </tr> <tr> <td>100+ \$15.35</td> </tr> </tbody> </table> <p>N Female to N Female</p> <p>VSWR 1.3:1 to 11 GHz</p> <p>Model No: <a href="#">PE9006</a></p>	PRICE	1-24 \$17.85	25-49 \$16.96	50-99 \$16.07	100+ \$15.35	 <table border="1"> <thead> <tr> <th>PRICE</th> </tr> </thead> <tbody> <tr> <td>1-24 \$71.22</td> </tr> <tr> <td>25-49 \$67.66</td> </tr> <tr> <td>50-99 \$64.10</td> </tr> <tr> <td>100+ \$61.25</td> </tr> </tbody> </table> <p>Low PIM</p> <p>N Female to N Female</p> <p>VSWR 1.2:1 to 6 GHz</p> <p>Model No: <a href="#">PE91140</a></p>	PRICE	1-24 \$71.22	25-49 \$67.66	50-99 \$64.10	100+ \$61.25
	PRICE																													
1-24 \$53.26																														
25-49 \$50.60																														
50-99 \$47.93																														
100+ \$45.80																														
PRICE																														
1-24 \$58.19																														
25-49 \$55.28																														
50-99 \$52.37																														
100+ \$50.04																														
PRICE																														
1-24 \$37.49																														
25-49 \$35.62																														
50-99 \$33.74																														
100+ \$32.24																														
PRICE																														
1-24 \$17.85																														
25-49 \$16.96																														
50-99 \$16.07																														
100+ \$15.35																														
PRICE																														
1-24 \$71.22																														
25-49 \$67.66																														
50-99 \$64.10																														
100+ \$61.25																														
7	 <table border="1"> <thead> <tr> <th>PRICE</th> </tr> </thead> <tbody> <tr> <td>1-24 \$47.60</td> </tr> <tr> <td>25-49 \$45.22</td> </tr> <tr> <td>50-99 \$42.84</td> </tr> <tr> <td>100+ \$40.94</td> </tr> </tbody> </table> <p>N Female to N Female</p> <p>VSWR 1.2:1 to 18 GHz</p> <p>Model No: <a href="#">PE91141</a></p>	PRICE	1-24 \$47.60	25-49 \$45.22	50-99 \$42.84	100+ \$40.94	 <table border="1"> <thead> <tr> <th>PRICE</th> </tr> </thead> <tbody> <tr> <td>1-24 \$53.32</td> </tr> <tr> <td>25-49 \$50.65</td> </tr> <tr> <td>50-99 \$47.99</td> </tr> <tr> <td>100+ \$45.86</td> </tr> </tbody> </table> <p>N Female to N Female Right Angle</p> <p>Model No: <a href="#">PE9359</a></p>	PRICE	1-24 \$53.32	25-49 \$50.65	50-99 \$47.99	100+ \$45.86	 <table border="1"> <thead> <tr> <th>PRICE</th> </tr> </thead> <tbody> <tr> <td>1-24 \$35.50</td> </tr> <tr> <td>25-49 \$33.73</td> </tr> <tr> <td>50-99 \$31.95</td> </tr> <tr> <td>100+ \$30.53</td> </tr> </tbody> </table> <p>N Female to N Female Tee</p> <p>VSWR 2:1 to 100 MHz</p> <p>Model No: <a href="#">PE9101</a></p>	PRICE	1-24 \$35.50	25-49 \$33.73	50-99 \$31.95	100+ \$30.53	 <table border="1"> <thead> <tr> <th>PRICE</th> </tr> </thead> <tbody> <tr> <td>1-24 \$100.74</td> </tr> <tr> <td>25-49 \$95.70</td> </tr> <tr> <td>50-99 \$90.67</td> </tr> <tr> <td>100+ \$86.64</td> </tr> </tbody> </table> <p>N Female to N Female Cross</p> <p>Model No: <a href="#">PE9548</a></p>	PRICE	1-24 \$100.74	25-49 \$95.70	50-99 \$90.67	100+ \$86.64	 <table border="1"> <thead> <tr> <th>PRICE</th> </tr> </thead> <tbody> <tr> <td>1-24 \$29.07</td> </tr> <tr> <td>25-49 \$27.62</td> </tr> <tr> <td>50-99 \$26.16</td> </tr> <tr> <td>100+ \$25.00</td> </tr> </tbody> </table> <p>N Female to N Female Bulkhead</p> <p>VSWR 1.4:1 to 3 GHz</p> <p>Model No: <a href="#">PE9128</a></p>	PRICE	1-24 \$29.07	25-49 \$27.62	50-99 \$26.16	100+ \$25.00
	PRICE																													
1-24 \$47.60																														
25-49 \$45.22																														
50-99 \$42.84																														
100+ \$40.94																														
PRICE																														
1-24 \$53.32																														
25-49 \$50.65																														
50-99 \$47.99																														
100+ \$45.86																														
PRICE																														
1-24 \$35.50																														
25-49 \$33.73																														
50-99 \$31.95																														
100+ \$30.53																														
PRICE																														
1-24 \$100.74																														
25-49 \$95.70																														
50-99 \$90.67																														
100+ \$86.64																														
PRICE																														
1-24 \$29.07																														
25-49 \$27.62																														
50-99 \$26.16																														
100+ \$25.00																														

# ADAPTERS

See Adapter Locator on Pages 8-13

See Page 369 for Mounting Holes

Adapters

See Our Website For Current Pricing & Real-Time Stock Availability!

	A	B	C	D	E																																													
1	 <table border="1"> <thead> <tr><th>PRICE</th></tr> </thead> <tbody> <tr><td>1-24</td><td>\$73.69</td></tr> <tr><td>25-49</td><td>\$70.01</td></tr> <tr><td>50-99</td><td>\$66.32</td></tr> <tr><td>100+</td><td>\$63.37</td></tr> </tbody> </table> <p><b>N Female to N Female Bulkhead</b> Max. Freq. 11 GHz</p> <p>Model No: <a href="#">PE9383</a></p>	PRICE	1-24	\$73.69	25-49	\$70.01	50-99	\$66.32	100+	\$63.37	 <table border="1"> <thead> <tr><th>PRICE</th></tr> </thead> <tbody> <tr><td>1-24</td><td>\$78.04</td></tr> <tr><td>25-49</td><td>\$74.14</td></tr> <tr><td>50-99</td><td>\$70.24</td></tr> <tr><td>100+</td><td>\$67.11</td></tr> </tbody> </table> <p><b>N Female to N Female Right Angle Bulkhead-Mounting Hole G01</b> Max. Freq. 6 GHz</p> <p>Model No: <a href="#">PE9541</a></p>	PRICE	1-24	\$78.04	25-49	\$74.14	50-99	\$70.24	100+	\$67.11	 <table border="1"> <thead> <tr><th>PRICE</th></tr> </thead> <tbody> <tr><td>1-24</td><td>\$31.85</td></tr> <tr><td>25-49</td><td>\$30.26</td></tr> <tr><td>50-99</td><td>\$28.67</td></tr> <tr><td>100+</td><td>\$27.39</td></tr> </tbody> </table> <p><b>N Female to N Female 4 Hole Flange-Mounting Hole A05</b> VSWR 1.5:1 to 11 GHz</p> <p>Model No: <a href="#">PE9173</a></p>	PRICE	1-24	\$31.85	25-49	\$30.26	50-99	\$28.67	100+	\$27.39	 <table border="1"> <thead> <tr><th>PRICE</th></tr> </thead> <tbody> <tr><td>1-9</td><td>\$138.51</td></tr> <tr><td>10-24</td><td>\$131.58</td></tr> <tr><td>25-49</td><td>\$124.66</td></tr> <tr><td>50+</td><td>\$119.12</td></tr> </tbody> </table> <p>PRECISION <b>N Female to N Female 4 Hole Flange-Mounting Hole A05</b> VSWR 1.15:1 to 18 GHz</p> <p>Model No: <a href="#">PE9429</a></p>	PRICE	1-9	\$138.51	10-24	\$131.58	25-49	\$124.66	50+	\$119.12	 <table border="1"> <thead> <tr><th>PRICE</th></tr> </thead> <tbody> <tr><td>1-24</td><td>\$71.43</td></tr> <tr><td>25-49</td><td>\$67.86</td></tr> <tr><td>50-99</td><td>\$64.29</td></tr> <tr><td>100+</td><td>\$61.43</td></tr> </tbody> </table> <p><b>N Female to N Female Bulkhead</b> VSWR 1.2:1 to 6 GHz</p> <p>Model No: <a href="#">PE91201</a></p>	PRICE	1-24	\$71.43	25-49	\$67.86	50-99	\$64.29	100+	\$61.43
PRICE																																																		
1-24	\$73.69																																																	
25-49	\$70.01																																																	
50-99	\$66.32																																																	
100+	\$63.37																																																	
PRICE																																																		
1-24	\$78.04																																																	
25-49	\$74.14																																																	
50-99	\$70.24																																																	
100+	\$67.11																																																	
PRICE																																																		
1-24	\$31.85																																																	
25-49	\$30.26																																																	
50-99	\$28.67																																																	
100+	\$27.39																																																	
PRICE																																																		
1-9	\$138.51																																																	
10-24	\$131.58																																																	
25-49	\$124.66																																																	
50+	\$119.12																																																	
PRICE																																																		
1-24	\$71.43																																																	
25-49	\$67.86																																																	
50-99	\$64.29																																																	
100+	\$61.43																																																	
2	 <table border="1"> <thead> <tr><th>PRICE</th></tr> </thead> <tbody> <tr><td>1-24</td><td>\$35.90</td></tr> <tr><td>25-49</td><td>\$34.11</td></tr> <tr><td>50-99</td><td>\$32.31</td></tr> <tr><td>100+</td><td>\$30.87</td></tr> </tbody> </table> <p><b>N Female to N Female Bulkhead</b> VSWR 1.3:1 to 6 GHz</p> <p>Model No: <a href="#">PE91238</a></p>	PRICE	1-24	\$35.90	25-49	\$34.11	50-99	\$32.31	100+	\$30.87	 <table border="1"> <thead> <tr><th>PRICE</th></tr> </thead> <tbody> <tr><td>1-24</td><td>\$63.79</td></tr> <tr><td>25-49</td><td>\$60.60</td></tr> <tr><td>50-99</td><td>\$57.41</td></tr> <tr><td>100+</td><td>\$54.86</td></tr> </tbody> </table> <p>Low PIM <b>N Female to N Female Bulkhead</b> VSWR 1.2:1 to 6 GHz</p> <p>Model No: <a href="#">PE91179</a></p>	PRICE	1-24	\$63.79	25-49	\$60.60	50-99	\$57.41	100+	\$54.86	 <table border="1"> <thead> <tr><th>PRICE</th></tr> </thead> <tbody> <tr><td>1-9</td><td>\$182.28</td></tr> <tr><td>10-24</td><td>\$173.17</td></tr> <tr><td>25-49</td><td>\$164.05</td></tr> <tr><td>50+</td><td>\$156.76</td></tr> </tbody> </table> <p>PRECISION <b>N Female to N Female Bulkhead</b> VSWR 1.15:1 to 18 GHz</p> <p>Model No: <a href="#">PE9500</a></p>	PRICE	1-9	\$182.28	10-24	\$173.17	25-49	\$164.05	50+	\$156.76	 <table border="1"> <thead> <tr><th>PRICE</th></tr> </thead> <tbody> <tr><td>1-24</td><td>\$45.25</td></tr> <tr><td>25-49</td><td>\$42.99</td></tr> <tr><td>50-99</td><td>\$40.73</td></tr> <tr><td>100+</td><td>\$38.92</td></tr> </tbody> </table> <p><b>N Female to N Female Bulkhead</b> VSWR 1.5:1 to 11 GHz</p> <p>Model No: <a href="#">PE9382</a></p>	PRICE	1-24	\$45.25	25-49	\$42.99	50-99	\$40.73	100+	\$38.92	<p style="text-align: center;"><b>Reverse Polarity N In-Series</b></p> <p style="text-align: center;">→</p>									
PRICE																																																		
1-24	\$35.90																																																	
25-49	\$34.11																																																	
50-99	\$32.31																																																	
100+	\$30.87																																																	
PRICE																																																		
1-24	\$63.79																																																	
25-49	\$60.60																																																	
50-99	\$57.41																																																	
100+	\$54.86																																																	
PRICE																																																		
1-9	\$182.28																																																	
10-24	\$173.17																																																	
25-49	\$164.05																																																	
50+	\$156.76																																																	
PRICE																																																		
1-24	\$45.25																																																	
25-49	\$42.99																																																	
50-99	\$40.73																																																	
100+	\$38.92																																																	
3	 <table border="1"> <thead> <tr><th>PRICE</th></tr> </thead> <tbody> <tr><td>1-24</td><td>\$42.97</td></tr> <tr><td>25-49</td><td>\$40.82</td></tr> <tr><td>50-99</td><td>\$38.67</td></tr> <tr><td>100+</td><td>\$36.95</td></tr> </tbody> </table> <p><b>N Male to Rev. Pol. N Female</b> Max. Freq. 11 GHz</p> <p>Model No: <a href="#">PE9771</a></p>	PRICE	1-24	\$42.97	25-49	\$40.82	50-99	\$38.67	100+	\$36.95	 <table border="1"> <thead> <tr><th>PRICE</th></tr> </thead> <tbody> <tr><td>1-24</td><td>\$42.32</td></tr> <tr><td>25-49</td><td>\$40.20</td></tr> <tr><td>50-99</td><td>\$38.09</td></tr> <tr><td>100+</td><td>\$36.40</td></tr> </tbody> </table> <p><b>N Female to Rev. Pol. N Male</b> Max. Freq. 11 GHz</p> <p>Model No: <a href="#">PE9770</a></p>	PRICE	1-24	\$42.32	25-49	\$40.20	50-99	\$38.09	100+	\$36.40	 <table border="1"> <thead> <tr><th>PRICE</th></tr> </thead> <tbody> <tr><td>1-24</td><td>\$42.97</td></tr> <tr><td>25-49</td><td>\$40.82</td></tr> <tr><td>50-99</td><td>\$38.67</td></tr> <tr><td>100+</td><td>\$36.95</td></tr> </tbody> </table> <p><b>Rev. Pol. N Female to Rev. Pol. N Female</b> VSWR 1.3:1 to 11 GHz</p> <p>Model No: <a href="#">PE9773</a></p>	PRICE	1-24	\$42.97	25-49	\$40.82	50-99	\$38.67	100+	\$36.95	<p style="text-align: center;"><b>N Between Series</b></p> <p style="text-align: center;">→</p>	 <table border="1"> <thead> <tr><th>PRICE</th></tr> </thead> <tbody> <tr><td>1-9</td><td>\$299.19</td></tr> <tr><td>10-24</td><td>\$284.23</td></tr> <tr><td>25-49</td><td>\$269.27</td></tr> <tr><td>50+</td><td>\$257.30</td></tr> </tbody> </table> <p>PRECISION <b>N Male to 7mm Sexless</b> VSWR 1.12:1 to 18 GHz</p> <p>Model No: <a href="#">PE9217</a></p>	PRICE	1-9	\$299.19	10-24	\$284.23	25-49	\$269.27	50+	\$257.30									
PRICE																																																		
1-24	\$42.97																																																	
25-49	\$40.82																																																	
50-99	\$38.67																																																	
100+	\$36.95																																																	
PRICE																																																		
1-24	\$42.32																																																	
25-49	\$40.20																																																	
50-99	\$38.09																																																	
100+	\$36.40																																																	
PRICE																																																		
1-24	\$42.97																																																	
25-49	\$40.82																																																	
50-99	\$38.67																																																	
100+	\$36.95																																																	
PRICE																																																		
1-9	\$299.19																																																	
10-24	\$284.23																																																	
25-49	\$269.27																																																	
50+	\$257.30																																																	
4	 <table border="1"> <thead> <tr><th>PRICE</th></tr> </thead> <tbody> <tr><td>1-24</td><td>\$73.94</td></tr> <tr><td>25-49</td><td>\$70.24</td></tr> <tr><td>50-99</td><td>\$66.55</td></tr> <tr><td>100+</td><td>\$63.59</td></tr> </tbody> </table> <p>Low PIM NEW <b>N Male to 4.3-10 Female</b> VSWR 1.08:1 to 6 GHz</p> <p>Model No: <a href="#">PE91388</a></p>	PRICE	1-24	\$73.94	25-49	\$70.24	50-99	\$66.55	100+	\$63.59	 <table border="1"> <thead> <tr><th>PRICE</th></tr> </thead> <tbody> <tr><td>1-24</td><td>\$91.69</td></tr> <tr><td>25-49</td><td>\$87.11</td></tr> <tr><td>50-99</td><td>\$82.52</td></tr> <tr><td>100+</td><td>\$78.85</td></tr> </tbody> </table> <p>Low PIM <b>N Male to 7/16 DIN Male</b> Max. Freq. 8 GHz</p> <p>Model No: <a href="#">PE91030</a></p>	PRICE	1-24	\$91.69	25-49	\$87.11	50-99	\$82.52	100+	\$78.85	 <table border="1"> <thead> <tr><th>PRICE</th></tr> </thead> <tbody> <tr><td>1-9</td><td>\$196.62</td></tr> <tr><td>10-24</td><td>\$186.79</td></tr> <tr><td>25-49</td><td>\$176.96</td></tr> <tr><td>50+</td><td>\$169.09</td></tr> </tbody> </table> <p><b>N Male to 7/16 DIN Male</b></p> <p>Model No: <a href="#">PE9535</a></p>	PRICE	1-9	\$196.62	10-24	\$186.79	25-49	\$176.96	50+	\$169.09	 <table border="1"> <thead> <tr><th>PRICE</th></tr> </thead> <tbody> <tr><td>1-24</td><td>\$98.25</td></tr> <tr><td>25-49</td><td>\$93.34</td></tr> <tr><td>50-99</td><td>\$88.43</td></tr> <tr><td>100+</td><td>\$84.50</td></tr> </tbody> </table> <p>Low PIM <b>N Male to 7/16 DIN Female</b> Max. Freq. 8 GHz</p> <p>Model No: <a href="#">PE91032</a></p>	PRICE	1-24	\$98.25	25-49	\$93.34	50-99	\$88.43	100+	\$84.50	 <table border="1"> <thead> <tr><th>PRICE</th></tr> </thead> <tbody> <tr><td>1-24</td><td>\$87.21</td></tr> <tr><td>25-49</td><td>\$82.85</td></tr> <tr><td>50-99</td><td>\$78.49</td></tr> <tr><td>100+</td><td>\$75.00</td></tr> </tbody> </table> <p><b>N Male to 7/16 DIN Female</b> VSWR 1.15:1 to 6 GHz</p> <p>Model No: <a href="#">PE91134</a></p>	PRICE	1-24	\$87.21	25-49	\$82.85	50-99	\$78.49	100+	\$75.00
PRICE																																																		
1-24	\$73.94																																																	
25-49	\$70.24																																																	
50-99	\$66.55																																																	
100+	\$63.59																																																	
PRICE																																																		
1-24	\$91.69																																																	
25-49	\$87.11																																																	
50-99	\$82.52																																																	
100+	\$78.85																																																	
PRICE																																																		
1-9	\$196.62																																																	
10-24	\$186.79																																																	
25-49	\$176.96																																																	
50+	\$169.09																																																	
PRICE																																																		
1-24	\$98.25																																																	
25-49	\$93.34																																																	
50-99	\$88.43																																																	
100+	\$84.50																																																	
PRICE																																																		
1-24	\$87.21																																																	
25-49	\$82.85																																																	
50-99	\$78.49																																																	
100+	\$75.00																																																	
5	 <table border="1"> <thead> <tr><th>PRICE</th></tr> </thead> <tbody> <tr><td>1-24</td><td>\$44.52</td></tr> <tr><td>25-49</td><td>\$42.29</td></tr> <tr><td>50-99</td><td>\$40.07</td></tr> <tr><td>100+</td><td>\$38.29</td></tr> </tbody> </table> <p><b>N Male to BNC Male</b> VSWR 1.3:1 to 4 GHz</p> <p>Model No: <a href="#">PE9127</a></p>	PRICE	1-24	\$44.52	25-49	\$42.29	50-99	\$40.07	100+	\$38.29	 <table border="1"> <thead> <tr><th>PRICE</th></tr> </thead> <tbody> <tr><td>1-9</td><td>\$192.88</td></tr> <tr><td>10-24</td><td>\$183.24</td></tr> <tr><td>25-49</td><td>\$173.59</td></tr> <tr><td>50+</td><td>\$165.88</td></tr> </tbody> </table> <p>PRECISION <b>N Male to BNC Male</b> VSWR 1.2:1 to 8 GHz</p> <p>Model No: <a href="#">PE9489</a></p>	PRICE	1-9	\$192.88	10-24	\$183.24	25-49	\$173.59	50+	\$165.88	 <table border="1"> <thead> <tr><th>PRICE</th></tr> </thead> <tbody> <tr><td>1-24</td><td>\$100.61</td></tr> <tr><td>25-49</td><td>\$95.58</td></tr> <tr><td>50-99</td><td>\$90.55</td></tr> <tr><td>100+</td><td>\$86.52</td></tr> </tbody> </table> <p><b>N Male to BNC Male Right Angle</b></p> <p>Model No: <a href="#">PE9565</a></p>	PRICE	1-24	\$100.61	25-49	\$95.58	50-99	\$90.55	100+	\$86.52	 <table border="1"> <thead> <tr><th>PRICE</th></tr> </thead> <tbody> <tr><td>1-24</td><td>\$23.25</td></tr> <tr><td>25-49</td><td>\$22.09</td></tr> <tr><td>50-99</td><td>\$20.93</td></tr> <tr><td>100+</td><td>\$20.00</td></tr> </tbody> </table> <p><b>N Male to BNC Female</b> VSWR 1.3:1 to 2 GHz</p> <p>Model No: <a href="#">PE9002</a></p>	PRICE	1-24	\$23.25	25-49	\$22.09	50-99	\$20.93	100+	\$20.00	 <table border="1"> <thead> <tr><th>PRICE</th></tr> </thead> <tbody> <tr><td>1-9</td><td>\$140.27</td></tr> <tr><td>10-24</td><td>\$133.26</td></tr> <tr><td>25-49</td><td>\$126.24</td></tr> <tr><td>50+</td><td>\$120.63</td></tr> </tbody> </table> <p>PRECISION <b>N Male to BNC Female</b> VSWR 1.2:1 to 8 GHz</p> <p>Model No: <a href="#">PE9491</a></p>	PRICE	1-9	\$140.27	10-24	\$133.26	25-49	\$126.24	50+	\$120.63
PRICE																																																		
1-24	\$44.52																																																	
25-49	\$42.29																																																	
50-99	\$40.07																																																	
100+	\$38.29																																																	
PRICE																																																		
1-9	\$192.88																																																	
10-24	\$183.24																																																	
25-49	\$173.59																																																	
50+	\$165.88																																																	
PRICE																																																		
1-24	\$100.61																																																	
25-49	\$95.58																																																	
50-99	\$90.55																																																	
100+	\$86.52																																																	
PRICE																																																		
1-24	\$23.25																																																	
25-49	\$22.09																																																	
50-99	\$20.93																																																	
100+	\$20.00																																																	
PRICE																																																		
1-9	\$140.27																																																	
10-24	\$133.26																																																	
25-49	\$126.24																																																	
50+	\$120.63																																																	
6	 <table border="1"> <thead> <tr><th>PRICE</th></tr> </thead> <tbody> <tr><td>1-24</td><td>\$83.12</td></tr> <tr><td>25-49</td><td>\$78.96</td></tr> <tr><td>50-99</td><td>\$74.81</td></tr> <tr><td>100+</td><td>\$71.48</td></tr> </tbody> </table> <p><b>N Male to BNC Female Right Angle</b> VSWR 1.2:1 to 4 GHz</p> <p>Model No: <a href="#">PE9278</a></p>	PRICE	1-24	\$83.12	25-49	\$78.96	50-99	\$74.81	100+	\$71.48	 <table border="1"> <thead> <tr><th>PRICE</th></tr> </thead> <tbody> <tr><td>1-24</td><td>\$62.86</td></tr> <tr><td>25-49</td><td>\$59.72</td></tr> <tr><td>50-99</td><td>\$56.57</td></tr> <tr><td>100+</td><td>\$54.06</td></tr> </tbody> </table> <p><b>N Male to BNC Female 4 Hole Flange</b> Max. Freq. 4 GHz</p> <p>Model No: <a href="#">PE9388</a></p>	PRICE	1-24	\$62.86	25-49	\$59.72	50-99	\$56.57	100+	\$54.06	 <table border="1"> <thead> <tr><th>PRICE</th></tr> </thead> <tbody> <tr><td>1-24</td><td>\$100.33</td></tr> <tr><td>25-49</td><td>\$95.31</td></tr> <tr><td>50-99</td><td>\$90.30</td></tr> <tr><td>100+</td><td>\$86.28</td></tr> </tbody> </table> <p><b>N Male to C Male</b></p> <p>Model No: <a href="#">PE9538</a></p>	PRICE	1-24	\$100.33	25-49	\$95.31	50-99	\$90.30	100+	\$86.28	 <table border="1"> <thead> <tr><th>PRICE</th></tr> </thead> <tbody> <tr><td>1-24</td><td>\$62.73</td></tr> <tr><td>25-49</td><td>\$59.59</td></tr> <tr><td>50-99</td><td>\$56.46</td></tr> <tr><td>100+</td><td>\$53.95</td></tr> </tbody> </table> <p><b>N Male to C Female</b> Max. Freq. 11 GHz</p> <p>Model No: <a href="#">PE91446</a></p>	PRICE	1-24	\$62.73	25-49	\$59.59	50-99	\$56.46	100+	\$53.95	 <table border="1"> <thead> <tr><th>PRICE</th></tr> </thead> <tbody> <tr><td>1-24</td><td>\$106.59</td></tr> <tr><td>25-49</td><td>\$101.26</td></tr> <tr><td>50-99</td><td>\$95.93</td></tr> <tr><td>100+</td><td>\$91.67</td></tr> </tbody> </table> <p><b>N Male to C Female Right Angle</b> Max. Freq. 4 GHz</p> <p>Model No: <a href="#">PE9239</a></p>	PRICE	1-24	\$106.59	25-49	\$101.26	50-99	\$95.93	100+	\$91.67
PRICE																																																		
1-24	\$83.12																																																	
25-49	\$78.96																																																	
50-99	\$74.81																																																	
100+	\$71.48																																																	
PRICE																																																		
1-24	\$62.86																																																	
25-49	\$59.72																																																	
50-99	\$56.57																																																	
100+	\$54.06																																																	
PRICE																																																		
1-24	\$100.33																																																	
25-49	\$95.31																																																	
50-99	\$90.30																																																	
100+	\$86.28																																																	
PRICE																																																		
1-24	\$62.73																																																	
25-49	\$59.59																																																	
50-99	\$56.46																																																	
100+	\$53.95																																																	
PRICE																																																		
1-24	\$106.59																																																	
25-49	\$101.26																																																	
50-99	\$95.93																																																	
100+	\$91.67																																																	
7	 <table border="1"> <thead> <tr><th>PRICE</th></tr> </thead> <tbody> <tr><td>1-24</td><td>\$28.85</td></tr> <tr><td>25-49</td><td>\$27.41</td></tr> <tr><td>50-99</td><td>\$25.97</td></tr> <tr><td>100+</td><td>\$24.81</td></tr> </tbody> </table> <p><b>N Male to 75 Ohm F Female</b> VSWR 1.3:1 to 250 MHz</p> <p>Model No: <a href="#">PE9155</a></p>	PRICE	1-24	\$28.85	25-49	\$27.41	50-99	\$25.97	100+	\$24.81	 <table border="1"> <thead> <tr><th>PRICE</th></tr> </thead> <tbody> <tr><td>1-24</td><td>\$23.62</td></tr> <tr><td>25-49</td><td>\$22.44</td></tr> <tr><td>50-99</td><td>\$21.26</td></tr> <tr><td>100+</td><td>\$20.31</td></tr> </tbody> </table> <p><b>N Male to FME Plug</b></p> <p>Model No: <a href="#">PE9704</a></p>	PRICE	1-24	\$23.62	25-49	\$22.44	50-99	\$21.26	100+	\$20.31	 <table border="1"> <thead> <tr><th>PRICE</th></tr> </thead> <tbody> <tr><td>1-9</td><td>\$182.70</td></tr> <tr><td>10-24</td><td>\$173.57</td></tr> <tr><td>25-49</td><td>\$164.43</td></tr> <tr><td>50+</td><td>\$157.12</td></tr> </tbody> </table> <p><b>N Male to GR874 Sexless</b></p> <p>Model No: <a href="#">PE9257</a></p>	PRICE	1-9	\$182.70	10-24	\$173.57	25-49	\$164.43	50+	\$157.12	 <table border="1"> <thead> <tr><th>PRICE</th></tr> </thead> <tbody> <tr><td>1-24</td><td>\$81.04</td></tr> <tr><td>25-49</td><td>\$76.99</td></tr> <tr><td>50-99</td><td>\$72.94</td></tr> <tr><td>100+</td><td>\$69.69</td></tr> </tbody> </table> <p><b>N Male to HN Male</b></p> <p>Model No: <a href="#">PE9554</a></p>	PRICE	1-24	\$81.04	25-49	\$76.99	50-99	\$72.94	100+	\$69.69	 <table border="1"> <thead> <tr><th>PRICE</th></tr> </thead> <tbody> <tr><td>1-24</td><td>\$51.96</td></tr> <tr><td>25-49</td><td>\$49.36</td></tr> <tr><td>50-99</td><td>\$46.76</td></tr> <tr><td>100+</td><td>\$44.69</td></tr> </tbody> </table> <p><b>N Male to HN Female</b> VSWR 1.3:1 to 4 GHz</p> <p>Model No: <a href="#">PE9125</a></p>	PRICE	1-24	\$51.96	25-49	\$49.36	50-99	\$46.76	100+	\$44.69
PRICE																																																		
1-24	\$28.85																																																	
25-49	\$27.41																																																	
50-99	\$25.97																																																	
100+	\$24.81																																																	
PRICE																																																		
1-24	\$23.62																																																	
25-49	\$22.44																																																	
50-99	\$21.26																																																	
100+	\$20.31																																																	
PRICE																																																		
1-9	\$182.70																																																	
10-24	\$173.57																																																	
25-49	\$164.43																																																	
50+	\$157.12																																																	
PRICE																																																		
1-24	\$81.04																																																	
25-49	\$76.99																																																	
50-99	\$72.94																																																	
100+	\$69.69																																																	
PRICE																																																		
1-24	\$51.96																																																	
25-49	\$49.36																																																	
50-99	\$46.76																																																	
100+	\$44.69																																																	



# ADAPTERS

See Adapter Locator on Pages 8-13

See Page 369 for Mounting Holes

	A	B	C	D	E																																													
1	 <table border="1"> <thead> <tr><th>PRICE</th></tr> </thead> <tbody> <tr><td>1-9</td><td>\$193.43</td></tr> <tr><td>10-24</td><td>\$183.76</td></tr> <tr><td>25-49</td><td>\$174.09</td></tr> <tr><td>50+</td><td>\$166.35</td></tr> </tbody> </table> <p>N Male to LC Female</p> <p>Model No: <a href="#">PE9299</a></p>	PRICE	1-9	\$193.43	10-24	\$183.76	25-49	\$174.09	50+	\$166.35	 <table border="1"> <thead> <tr><th>PRICE</th></tr> </thead> <tbody> <tr><td>1-24</td><td>\$89.44</td></tr> <tr><td>25-49</td><td>\$85.86</td></tr> <tr><td>50-99</td><td>\$83.18</td></tr> <tr><td>100+</td><td>\$81.39</td></tr> </tbody> </table> <p>N Male to MCX Plug</p> <p>Model No: <a href="#">PE9465</a></p>	PRICE	1-24	\$89.44	25-49	\$85.86	50-99	\$83.18	100+	\$81.39	 <table border="1"> <thead> <tr><th>PRICE</th></tr> </thead> <tbody> <tr><td>1-9</td><td>\$128.20</td></tr> <tr><td>10-24</td><td>\$121.79</td></tr> <tr><td>25-49</td><td>\$115.38</td></tr> <tr><td>50+</td><td>\$110.25</td></tr> </tbody> </table> <p>N Male to MCX Jack</p> <p>Max. Freq. 6 GHz</p> <p>Model No: <a href="#">PE9464</a></p>	PRICE	1-9	\$128.20	10-24	\$121.79	25-49	\$115.38	50+	\$110.25	 <table border="1"> <thead> <tr><th>PRICE</th></tr> </thead> <tbody> <tr><td>1-24</td><td>\$23.96</td></tr> <tr><td>25-49</td><td>\$22.76</td></tr> <tr><td>50-99</td><td>\$21.56</td></tr> <tr><td>100+</td><td>\$20.61</td></tr> </tbody> </table> <p>N Male to Mini UHF Female</p> <p>Max. Freq. 2.5 GHz</p> <p>Model No: <a href="#">PE9064</a></p>	PRICE	1-24	\$23.96	25-49	\$22.76	50-99	\$21.56	100+	\$20.61	 <table border="1"> <thead> <tr><th>PRICE</th></tr> </thead> <tbody> <tr><td>1-9</td><td>\$211.54</td></tr> <tr><td>10-24</td><td>\$200.96</td></tr> <tr><td>25-49</td><td>\$190.39</td></tr> <tr><td>50+</td><td>\$181.92</td></tr> </tbody> </table> <p>N Male to QMA Female</p> <p>Max. Freq. 11 GHz</p> <p>Model No: <a href="#">PE9787</a></p>	PRICE	1-9	\$211.54	10-24	\$200.96	25-49	\$190.39	50+	\$181.92
	PRICE																																																	
1-9	\$193.43																																																	
10-24	\$183.76																																																	
25-49	\$174.09																																																	
50+	\$166.35																																																	
PRICE																																																		
1-24	\$89.44																																																	
25-49	\$85.86																																																	
50-99	\$83.18																																																	
100+	\$81.39																																																	
PRICE																																																		
1-9	\$128.20																																																	
10-24	\$121.79																																																	
25-49	\$115.38																																																	
50+	\$110.25																																																	
PRICE																																																		
1-24	\$23.96																																																	
25-49	\$22.76																																																	
50-99	\$21.56																																																	
100+	\$20.61																																																	
PRICE																																																		
1-9	\$211.54																																																	
10-24	\$200.96																																																	
25-49	\$190.39																																																	
50+	\$181.92																																																	
2	 <table border="1"> <thead> <tr><th>PRICE</th></tr> </thead> <tbody> <tr><td>1-9</td><td>\$121.83</td></tr> <tr><td>10-24</td><td>\$115.74</td></tr> <tr><td>25-49</td><td>\$109.65</td></tr> <tr><td>50+</td><td>\$104.77</td></tr> </tbody> </table> <p>N Male to SC Male</p> <p>Model No: <a href="#">PE9570</a></p>	PRICE	1-9	\$121.83	10-24	\$115.74	25-49	\$109.65	50+	\$104.77	 <table border="1"> <thead> <tr><th>PRICE</th></tr> </thead> <tbody> <tr><td>1-9</td><td>\$108.71</td></tr> <tr><td>10-24</td><td>\$103.27</td></tr> <tr><td>25-49</td><td>\$97.84</td></tr> <tr><td>50+</td><td>\$93.49</td></tr> </tbody> </table> <p>N Male to SC Female</p> <p>VSWR 1.25:1 to 11 GHz</p> <p>Model No: <a href="#">PE9196</a></p>	PRICE	1-9	\$108.71	10-24	\$103.27	25-49	\$97.84	50+	\$93.49	 <table border="1"> <thead> <tr><th>PRICE</th></tr> </thead> <tbody> <tr><td>1-24</td><td>\$51.36</td></tr> <tr><td>25-49</td><td>\$48.79</td></tr> <tr><td>50-99</td><td>\$46.22</td></tr> <tr><td>100+</td><td>\$44.17</td></tr> </tbody> </table> <p>Low PIM</p> <p>N Male to SMA Female</p> <p>VSWR 1.2:1 to 6 GHz</p> <p>Model No: <a href="#">PE91177</a></p>	PRICE	1-24	\$51.36	25-49	\$48.79	50-99	\$46.22	100+	\$44.17	 <table border="1"> <thead> <tr><th>PRICE</th></tr> </thead> <tbody> <tr><td>1-24</td><td>\$96.96</td></tr> <tr><td>25-49</td><td>\$92.11</td></tr> <tr><td>50-99</td><td>\$87.26</td></tr> <tr><td>100+</td><td>\$83.39</td></tr> </tbody> </table> <p>N Male to SMB Plug</p> <p>Model No: <a href="#">PE9314</a></p>	PRICE	1-24	\$96.96	25-49	\$92.11	50-99	\$87.26	100+	\$83.39	 <table border="1"> <thead> <tr><th>PRICE</th></tr> </thead> <tbody> <tr><td>1-24</td><td>\$69.80</td></tr> <tr><td>25-49</td><td>\$66.31</td></tr> <tr><td>50-99</td><td>\$62.82</td></tr> <tr><td>100+</td><td>\$60.03</td></tr> </tbody> </table> <p>N Male to SMB Jack</p> <p>Model No: <a href="#">PE9313</a></p>	PRICE	1-24	\$69.80	25-49	\$66.31	50-99	\$62.82	100+	\$60.03
	PRICE																																																	
1-9	\$121.83																																																	
10-24	\$115.74																																																	
25-49	\$109.65																																																	
50+	\$104.77																																																	
PRICE																																																		
1-9	\$108.71																																																	
10-24	\$103.27																																																	
25-49	\$97.84																																																	
50+	\$93.49																																																	
PRICE																																																		
1-24	\$51.36																																																	
25-49	\$48.79																																																	
50-99	\$46.22																																																	
100+	\$44.17																																																	
PRICE																																																		
1-24	\$96.96																																																	
25-49	\$92.11																																																	
50-99	\$87.26																																																	
100+	\$83.39																																																	
PRICE																																																		
1-24	\$69.80																																																	
25-49	\$66.31																																																	
50-99	\$62.82																																																	
100+	\$60.03																																																	
3	 <table border="1"> <thead> <tr><th>PRICE</th></tr> </thead> <tbody> <tr><td>1-24</td><td>\$95.42</td></tr> <tr><td>25-49</td><td>\$90.65</td></tr> <tr><td>50-99</td><td>\$85.88</td></tr> <tr><td>100+</td><td>\$82.06</td></tr> </tbody> </table> <p>N Male to SMC Plug</p> <p>Model No: <a href="#">PE9318</a></p>	PRICE	1-24	\$95.42	25-49	\$90.65	50-99	\$85.88	100+	\$82.06	 <table border="1"> <thead> <tr><th>PRICE</th></tr> </thead> <tbody> <tr><td>1-24</td><td>\$84.35</td></tr> <tr><td>25-49</td><td>\$80.13</td></tr> <tr><td>50-99</td><td>\$75.92</td></tr> <tr><td>100+</td><td>\$72.54</td></tr> </tbody> </table> <p>N Male to SMC Jack</p> <p>Model No: <a href="#">PE9317</a></p>	PRICE	1-24	\$84.35	25-49	\$80.13	50-99	\$75.92	100+	\$72.54	 <table border="1"> <thead> <tr><th>PRICE</th></tr> </thead> <tbody> <tr><td>1-24</td><td>\$24.82</td></tr> <tr><td>25-49</td><td>\$23.58</td></tr> <tr><td>50-99</td><td>\$22.34</td></tr> <tr><td>100+</td><td>\$21.35</td></tr> </tbody> </table> <p>N Male to TNC Male</p> <p>VSWR 1.5:1 to 11 GHz</p> <p>Model No: <a href="#">PE9130</a></p>	PRICE	1-24	\$24.82	25-49	\$23.58	50-99	\$22.34	100+	\$21.35	 <table border="1"> <thead> <tr><th>PRICE</th></tr> </thead> <tbody> <tr><td>1-9</td><td>\$154.34</td></tr> <tr><td>10-24</td><td>\$146.62</td></tr> <tr><td>25-49</td><td>\$138.91</td></tr> <tr><td>50+</td><td>\$132.73</td></tr> </tbody> </table> <p>PRECISION</p> <p>N Male to TNC Male</p> <p>VSWR 1.15:1 to 18 GHz</p> <p>Model No: <a href="#">PE9446</a></p>	PRICE	1-9	\$154.34	10-24	\$146.62	25-49	\$138.91	50+	\$132.73	 <table border="1"> <thead> <tr><th>PRICE</th></tr> </thead> <tbody> <tr><td>1-24</td><td>\$22.50</td></tr> <tr><td>25-49</td><td>\$21.38</td></tr> <tr><td>50-99</td><td>\$20.25</td></tr> <tr><td>100+</td><td>\$19.35</td></tr> </tbody> </table> <p>N Male to TNC Female</p> <p>VSWR 1.5:1 to 1,000 MHz</p> <p>Model No: <a href="#">PE9090</a></p>	PRICE	1-24	\$22.50	25-49	\$21.38	50-99	\$20.25	100+	\$19.35
	PRICE																																																	
1-24	\$95.42																																																	
25-49	\$90.65																																																	
50-99	\$85.88																																																	
100+	\$82.06																																																	
PRICE																																																		
1-24	\$84.35																																																	
25-49	\$80.13																																																	
50-99	\$75.92																																																	
100+	\$72.54																																																	
PRICE																																																		
1-24	\$24.82																																																	
25-49	\$23.58																																																	
50-99	\$22.34																																																	
100+	\$21.35																																																	
PRICE																																																		
1-9	\$154.34																																																	
10-24	\$146.62																																																	
25-49	\$138.91																																																	
50+	\$132.73																																																	
PRICE																																																		
1-24	\$22.50																																																	
25-49	\$21.38																																																	
50-99	\$20.25																																																	
100+	\$19.35																																																	
4	 <table border="1"> <thead> <tr><th>PRICE</th></tr> </thead> <tbody> <tr><td>1-9</td><td>\$128.42</td></tr> <tr><td>10-24</td><td>\$122.00</td></tr> <tr><td>25-49</td><td>\$115.58</td></tr> <tr><td>50+</td><td>\$110.44</td></tr> </tbody> </table> <p>PRECISION</p> <p>N Male to TNC Female</p> <p>VSWR 1.15:1 to 18 GHz</p> <p>Model No: <a href="#">PE9448</a></p>	PRICE	1-9	\$128.42	10-24	\$122.00	25-49	\$115.58	50+	\$110.44	 <table border="1"> <thead> <tr><th>PRICE</th></tr> </thead> <tbody> <tr><td>1-24</td><td>\$83.38</td></tr> <tr><td>25-49</td><td>\$79.21</td></tr> <tr><td>50-99</td><td>\$75.04</td></tr> <tr><td>100+</td><td>\$71.71</td></tr> </tbody> </table> <p>N Male to TNC Female Right Angle</p> <p>VSWR 1.33:1 to 6 GHz</p> <p>Model No: <a href="#">PE9550</a></p>	PRICE	1-24	\$83.38	25-49	\$79.21	50-99	\$75.04	100+	\$71.71	 <table border="1"> <thead> <tr><th>PRICE</th></tr> </thead> <tbody> <tr><td>1-24</td><td>\$35.87</td></tr> <tr><td>25-49</td><td>\$34.08</td></tr> <tr><td>50-99</td><td>\$32.28</td></tr> <tr><td>100+</td><td>\$30.85</td></tr> </tbody> </table> <p>N Male to UHF Male</p> <p>Model No: <a href="#">PE9113</a></p>	PRICE	1-24	\$35.87	25-49	\$34.08	50-99	\$32.28	100+	\$30.85	 <table border="1"> <thead> <tr><th>PRICE</th></tr> </thead> <tbody> <tr><td>1-24</td><td>\$33.60</td></tr> <tr><td>25-49</td><td>\$31.92</td></tr> <tr><td>50-99</td><td>\$30.24</td></tr> <tr><td>100+</td><td>\$28.90</td></tr> </tbody> </table> <p>N Male to UHF Female</p> <p>VSWR 1.3:1 to 300 MHz</p> <p>Model No: <a href="#">PE9111</a></p>	PRICE	1-24	\$33.60	25-49	\$31.92	50-99	\$30.24	100+	\$28.90	 <table border="1"> <thead> <tr><th>PRICE</th></tr> </thead> <tbody> <tr><td>1-9</td><td>\$308.07</td></tr> <tr><td>10-24</td><td>\$295.75</td></tr> <tr><td>25-49</td><td>\$286.51</td></tr> <tr><td>50+</td><td>\$280.34</td></tr> </tbody> </table> <p>PRECISION</p> <p>N Female to 7mm Sexless</p> <p>VSWR 1.15:1 to 18 GHz</p> <p>Model No: <a href="#">PE9216</a></p>	PRICE	1-9	\$308.07	10-24	\$295.75	25-49	\$286.51	50+	\$280.34
	PRICE																																																	
1-9	\$128.42																																																	
10-24	\$122.00																																																	
25-49	\$115.58																																																	
50+	\$110.44																																																	
PRICE																																																		
1-24	\$83.38																																																	
25-49	\$79.21																																																	
50-99	\$75.04																																																	
100+	\$71.71																																																	
PRICE																																																		
1-24	\$35.87																																																	
25-49	\$34.08																																																	
50-99	\$32.28																																																	
100+	\$30.85																																																	
PRICE																																																		
1-24	\$33.60																																																	
25-49	\$31.92																																																	
50-99	\$30.24																																																	
100+	\$28.90																																																	
PRICE																																																		
1-9	\$308.07																																																	
10-24	\$295.75																																																	
25-49	\$286.51																																																	
50+	\$280.34																																																	
5	 <table border="1"> <thead> <tr><th>PRICE</th></tr> </thead> <tbody> <tr><td>1-24</td><td>\$96.37</td></tr> <tr><td>25-49</td><td>\$91.55</td></tr> <tr><td>50-99</td><td>\$86.73</td></tr> <tr><td>100+</td><td>\$82.88</td></tr> </tbody> </table> <p>Low PIM</p> <p>N Female to 7/16 DIN Male</p> <p>Max. Freq. 8 GHz</p> <p>Model No: <a href="#">PE91031</a></p>	PRICE	1-24	\$96.37	25-49	\$91.55	50-99	\$86.73	100+	\$82.88	 <table border="1"> <thead> <tr><th>PRICE</th></tr> </thead> <tbody> <tr><td>1-24</td><td>\$98.25</td></tr> <tr><td>25-49</td><td>\$93.34</td></tr> <tr><td>50-99</td><td>\$88.43</td></tr> <tr><td>100+</td><td>\$84.50</td></tr> </tbody> </table> <p>Low PIM</p> <p>N Female to 7/16 DIN Female</p> <p>Max. Freq. 8 GHz</p> <p>Model No: <a href="#">PE91033</a></p>	PRICE	1-24	\$98.25	25-49	\$93.34	50-99	\$88.43	100+	\$84.50	 <table border="1"> <thead> <tr><th>PRICE</th></tr> </thead> <tbody> <tr><td>1-9</td><td>\$141.81</td></tr> <tr><td>10-24</td><td>\$134.72</td></tr> <tr><td>25-49</td><td>\$127.63</td></tr> <tr><td>50+</td><td>\$121.96</td></tr> </tbody> </table> <p>Low PIM</p> <p>N Female to 7/16 DIN Female</p> <p>Max. Freq. 8 GHz</p> <p>Model No: <a href="#">PE9180</a></p>	PRICE	1-9	\$141.81	10-24	\$134.72	25-49	\$127.63	50+	\$121.96	 <table border="1"> <thead> <tr><th>PRICE</th></tr> </thead> <tbody> <tr><td>1-24</td><td>\$21.79</td></tr> <tr><td>25-49</td><td>\$20.70</td></tr> <tr><td>50-99</td><td>\$19.61</td></tr> <tr><td>100+</td><td>\$18.74</td></tr> </tbody> </table> <p>N Female to BNC Male</p> <p>VSWR 1.3:1 to 4 GHz</p> <p>Model No: <a href="#">PE9005</a></p>	PRICE	1-24	\$21.79	25-49	\$20.70	50-99	\$19.61	100+	\$18.74	 <table border="1"> <thead> <tr><th>PRICE</th></tr> </thead> <tbody> <tr><td>1-9</td><td>\$139.08</td></tr> <tr><td>10-24</td><td>\$132.13</td></tr> <tr><td>25-49</td><td>\$125.17</td></tr> <tr><td>50+</td><td>\$119.61</td></tr> </tbody> </table> <p>PRECISION</p> <p>N Female to BNC Male</p> <p>VSWR 1.2:1 to 8 GHz</p> <p>Model No: <a href="#">PE9490</a></p>	PRICE	1-9	\$139.08	10-24	\$132.13	25-49	\$125.17	50+	\$119.61
	PRICE																																																	
1-24	\$96.37																																																	
25-49	\$91.55																																																	
50-99	\$86.73																																																	
100+	\$82.88																																																	
PRICE																																																		
1-24	\$98.25																																																	
25-49	\$93.34																																																	
50-99	\$88.43																																																	
100+	\$84.50																																																	
PRICE																																																		
1-9	\$141.81																																																	
10-24	\$134.72																																																	
25-49	\$127.63																																																	
50+	\$121.96																																																	
PRICE																																																		
1-24	\$21.79																																																	
25-49	\$20.70																																																	
50-99	\$19.61																																																	
100+	\$18.74																																																	
PRICE																																																		
1-9	\$139.08																																																	
10-24	\$132.13																																																	
25-49	\$125.17																																																	
50+	\$119.61																																																	
6	 <table border="1"> <thead> <tr><th>PRICE</th></tr> </thead> <tbody> <tr><td>1-24</td><td>\$61.97</td></tr> <tr><td>25-49</td><td>\$58.87</td></tr> <tr><td>50-99</td><td>\$55.77</td></tr> <tr><td>100+</td><td>\$53.29</td></tr> </tbody> </table> <p>N Female to BNC Male Right Angle</p> <p>Max. Freq. 4 GHz</p> <p>Model No: <a href="#">PE9566</a></p>	PRICE	1-24	\$61.97	25-49	\$58.87	50-99	\$55.77	100+	\$53.29	 <table border="1"> <thead> <tr><th>PRICE</th></tr> </thead> <tbody> <tr><td>1-24</td><td>\$81.58</td></tr> <tr><td>25-49</td><td>\$77.50</td></tr> <tr><td>50-99</td><td>\$73.42</td></tr> <tr><td>100+</td><td>\$70.16</td></tr> </tbody> </table> <p>N Female to BNC Male 4 Hole Flange-Mounting Hole A05</p> <p>Model No: <a href="#">PE9123</a></p>	PRICE	1-24	\$81.58	25-49	\$77.50	50-99	\$73.42	100+	\$70.16	 <table border="1"> <thead> <tr><th>PRICE</th></tr> </thead> <tbody> <tr><td>1-24</td><td>\$25.86</td></tr> <tr><td>25-49</td><td>\$24.57</td></tr> <tr><td>50-99</td><td>\$23.27</td></tr> <tr><td>100+</td><td>\$22.24</td></tr> </tbody> </table> <p>N Female to BNC Female</p> <p>VSWR 1.5:1 to 3 GHz</p> <p>Model No: <a href="#">PE9206</a></p>	PRICE	1-24	\$25.86	25-49	\$24.57	50-99	\$23.27	100+	\$22.24	 <table border="1"> <thead> <tr><th>PRICE</th></tr> </thead> <tbody> <tr><td>1-9</td><td>\$176.26</td></tr> <tr><td>10-24</td><td>\$167.45</td></tr> <tr><td>25-49</td><td>\$158.63</td></tr> <tr><td>50+</td><td>\$151.58</td></tr> </tbody> </table> <p>PRECISION</p> <p>N Female to BNC Female</p> <p>VSWR 1.2:1 to 8 GHz</p> <p>Model No: <a href="#">PE9492</a></p>	PRICE	1-9	\$176.26	10-24	\$167.45	25-49	\$158.63	50+	\$151.58	 <table border="1"> <thead> <tr><th>PRICE</th></tr> </thead> <tbody> <tr><td>1-24</td><td>\$65.04</td></tr> <tr><td>25-49</td><td>\$61.79</td></tr> <tr><td>50-99</td><td>\$58.54</td></tr> <tr><td>100+</td><td>\$55.93</td></tr> </tbody> </table> <p>N Female to BNC Female Bulkhead-Mounting Hole G01</p> <p>Model No: <a href="#">PE9261</a></p>	PRICE	1-24	\$65.04	25-49	\$61.79	50-99	\$58.54	100+	\$55.93
	PRICE																																																	
1-24	\$61.97																																																	
25-49	\$58.87																																																	
50-99	\$55.77																																																	
100+	\$53.29																																																	
PRICE																																																		
1-24	\$81.58																																																	
25-49	\$77.50																																																	
50-99	\$73.42																																																	
100+	\$70.16																																																	
PRICE																																																		
1-24	\$25.86																																																	
25-49	\$24.57																																																	
50-99	\$23.27																																																	
100+	\$22.24																																																	
PRICE																																																		
1-9	\$176.26																																																	
10-24	\$167.45																																																	
25-49	\$158.63																																																	
50+	\$151.58																																																	
PRICE																																																		
1-24	\$65.04																																																	
25-49	\$61.79																																																	
50-99	\$58.54																																																	
100+	\$55.93																																																	
7	 <table border="1"> <thead> <tr><th>PRICE</th></tr> </thead> <tbody> <tr><td>1-24</td><td>\$57.45</td></tr> <tr><td>25-49</td><td>\$54.58</td></tr> <tr><td>50-99</td><td>\$51.71</td></tr> <tr><td>100+</td><td>\$49.41</td></tr> </tbody> </table> <p>N Female to BNC Female 4 Hole Flange-Mounting Hole A05</p> <p>VSWR 1.2:1 to 6 GHz</p> <p>Model No: <a href="#">PE9238</a></p>	PRICE	1-24	\$57.45	25-49	\$54.58	50-99	\$51.71	100+	\$49.41	 <table border="1"> <thead> <tr><th>PRICE</th></tr> </thead> <tbody> <tr><td>1-24</td><td>\$69.32</td></tr> <tr><td>25-49</td><td>\$65.85</td></tr> <tr><td>50-99</td><td>\$62.39</td></tr> <tr><td>100+</td><td>\$59.62</td></tr> </tbody> </table> <p>N Female to BNC Female Bulkhead-Mounting Hole G01</p> <p>Max. Freq. 4 GHz</p> <p>Model No: <a href="#">PE9540</a></p>	PRICE	1-24	\$69.32	25-49	\$65.85	50-99	\$62.39	100+	\$59.62	 <table border="1"> <thead> <tr><th>PRICE</th></tr> </thead> <tbody> <tr><td>1-24</td><td>\$61.60</td></tr> <tr><td>25-49</td><td>\$58.52</td></tr> <tr><td>50-99</td><td>\$55.44</td></tr> <tr><td>100+</td><td>\$52.98</td></tr> </tbody> </table> <p>N Female to C Male</p> <p>VSWR 1.25:1 to 11 GHz</p> <p>Model No: <a href="#">PE9295</a></p>	PRICE	1-24	\$61.60	25-49	\$58.52	50-99	\$55.44	100+	\$52.98	 <table border="1"> <thead> <tr><th>PRICE</th></tr> </thead> <tbody> <tr><td>1-24</td><td>\$90.02</td></tr> <tr><td>25-49</td><td>\$85.52</td></tr> <tr><td>50-99</td><td>\$81.02</td></tr> <tr><td>100+</td><td>\$77.42</td></tr> </tbody> </table> <p>N Female to C Female</p> <p>Model No: <a href="#">PE9539</a></p>	PRICE	1-24	\$90.02	25-49	\$85.52	50-99	\$81.02	100+	\$77.42	 <table border="1"> <thead> <tr><th>PRICE</th></tr> </thead> <tbody> <tr><td>1-24</td><td>\$41.17</td></tr> <tr><td>25-49</td><td>\$39.11</td></tr> <tr><td>50-99</td><td>\$37.05</td></tr> <tr><td>100+</td><td>\$35.41</td></tr> </tbody> </table> <p>N Female to 75 Ohm F Male</p> <p>VSWR 1.3:1 to 250 MHz</p> <p>Model No: <a href="#">PE9389</a></p>	PRICE	1-24	\$41.17	25-49	\$39.11	50-99	\$37.05	100+	\$35.41
	PRICE																																																	
1-24	\$57.45																																																	
25-49	\$54.58																																																	
50-99	\$51.71																																																	
100+	\$49.41																																																	
PRICE																																																		
1-24	\$69.32																																																	
25-49	\$65.85																																																	
50-99	\$62.39																																																	
100+	\$59.62																																																	
PRICE																																																		
1-24	\$61.60																																																	
25-49	\$58.52																																																	
50-99	\$55.44																																																	
100+	\$52.98																																																	
PRICE																																																		
1-24	\$90.02																																																	
25-49	\$85.52																																																	
50-99	\$81.02																																																	
100+	\$77.42																																																	
PRICE																																																		
1-24	\$41.17																																																	
25-49	\$39.11																																																	
50-99	\$37.05																																																	
100+	\$35.41																																																	



Technical Support  
+1 (949) 261-1920



Same-Day Shipping,  
Even Custom Cable Assemblies

# ADAPTERS

See Adapter Locator on Pages 8-13

See Page 369 for Mounting Holes

Adapters

See Our Website For Current Pricing & Real-Time Stock Availability!

	A	B	C	D	E																																																		
1	 <table border="1"> <thead> <tr> <th colspan="2">PRICE</th> </tr> </thead> <tbody> <tr> <td>1-9</td> <td>\$177.46</td> </tr> <tr> <td>10-24</td> <td>\$168.59</td> </tr> <tr> <td>25-49</td> <td>\$159.71</td> </tr> <tr> <td>50+</td> <td>\$152.62</td> </tr> </tbody> </table> <p>N Female to GR874 Sexless</p> <p>Model No: <a href="#">PE9258</a></p>	PRICE		1-9	\$177.46	10-24	\$168.59	25-49	\$159.71	50+	\$152.62	 <table border="1"> <thead> <tr> <th colspan="2">PRICE</th> </tr> </thead> <tbody> <tr> <td>1-24</td> <td>\$52.97</td> </tr> <tr> <td>25-49</td> <td>\$50.32</td> </tr> <tr> <td>50-99</td> <td>\$47.67</td> </tr> <tr> <td>100+</td> <td>\$45.55</td> </tr> </tbody> </table> <p>N Female to HN Male</p> <p>VSWR 1.3:1 to 3 GHz</p> <p>Model No: <a href="#">PE9194</a></p>	PRICE		1-24	\$52.97	25-49	\$50.32	50-99	\$47.67	100+	\$45.55	 <table border="1"> <thead> <tr> <th colspan="2">PRICE</th> </tr> </thead> <tbody> <tr> <td>1-24</td> <td>\$75.55</td> </tr> <tr> <td>25-49</td> <td>\$71.77</td> </tr> <tr> <td>50-99</td> <td>\$68.00</td> </tr> <tr> <td>100+</td> <td>\$64.97</td> </tr> </tbody> </table> <p>N Female to HN Female</p> <p>Model No: <a href="#">PE9360</a></p>	PRICE		1-24	\$75.55	25-49	\$71.77	50-99	\$68.00	100+	\$64.97	 <table border="1"> <thead> <tr> <th colspan="2">PRICE</th> </tr> </thead> <tbody> <tr> <td>1-24</td> <td>\$113.65</td> </tr> <tr> <td>25-49</td> <td>\$107.97</td> </tr> <tr> <td>50-99</td> <td>\$102.29</td> </tr> <tr> <td>100+</td> <td>\$97.74</td> </tr> </tbody> </table> <p>N Female to HN Female 4 Hole Flange-Mounting Hole A08</p> <p>Model No: <a href="#">PE9553</a></p>	PRICE		1-24	\$113.65	25-49	\$107.97	50-99	\$102.29	100+	\$97.74	 <table border="1"> <thead> <tr> <th colspan="2">PRICE</th> </tr> </thead> <tbody> <tr> <td>1-9</td> <td>\$241.94</td> </tr> <tr> <td>10-24</td> <td>\$229.84</td> </tr> <tr> <td>25-49</td> <td>\$217.75</td> </tr> <tr> <td>50+</td> <td>\$208.07</td> </tr> </tbody> </table> <p>N Female to LC Male</p> <p>Max. Freq. 1,000 MHz</p> <p>Model No: <a href="#">PE9237</a></p>	PRICE		1-9	\$241.94	10-24	\$229.84	25-49	\$217.75	50+	\$208.07
	PRICE																																																						
1-9	\$177.46																																																						
10-24	\$168.59																																																						
25-49	\$159.71																																																						
50+	\$152.62																																																						
PRICE																																																							
1-24	\$52.97																																																						
25-49	\$50.32																																																						
50-99	\$47.67																																																						
100+	\$45.55																																																						
PRICE																																																							
1-24	\$75.55																																																						
25-49	\$71.77																																																						
50-99	\$68.00																																																						
100+	\$64.97																																																						
PRICE																																																							
1-24	\$113.65																																																						
25-49	\$107.97																																																						
50-99	\$102.29																																																						
100+	\$97.74																																																						
PRICE																																																							
1-9	\$241.94																																																						
10-24	\$229.84																																																						
25-49	\$217.75																																																						
50+	\$208.07																																																						
2	 <table border="1"> <thead> <tr> <th colspan="2">PRICE</th> </tr> </thead> <tbody> <tr> <td>1-9</td> <td>\$259.16</td> </tr> <tr> <td>10-24</td> <td>\$246.20</td> </tr> <tr> <td>25-49</td> <td>\$233.24</td> </tr> <tr> <td>50+</td> <td>\$222.88</td> </tr> </tbody> </table> <p>N Female to LC Female</p> <p>Model No: <a href="#">PE9298</a></p>	PRICE		1-9	\$259.16	10-24	\$246.20	25-49	\$233.24	50+	\$222.88	 <table border="1"> <thead> <tr> <th colspan="2">PRICE</th> </tr> </thead> <tbody> <tr> <td>1-24</td> <td>\$101.72</td> </tr> <tr> <td>25-49</td> <td>\$97.65</td> </tr> <tr> <td>50-99</td> <td>\$94.60</td> </tr> <tr> <td>100+</td> <td>\$92.57</td> </tr> </tbody> </table> <p>N Female to MCX Plug</p> <p>Max. Freq. 6 GHz</p> <p>Model No: <a href="#">PE9463</a></p>	PRICE		1-24	\$101.72	25-49	\$97.65	50-99	\$94.60	100+	\$92.57	 <table border="1"> <thead> <tr> <th colspan="2">PRICE</th> </tr> </thead> <tbody> <tr> <td>1-9</td> <td>\$128.20</td> </tr> <tr> <td>10-24</td> <td>\$121.79</td> </tr> <tr> <td>25-49</td> <td>\$115.38</td> </tr> <tr> <td>50+</td> <td>\$110.25</td> </tr> </tbody> </table> <p>N Female to MCX Jack</p> <p>Max. Freq. 6 GHz</p> <p>Model No: <a href="#">PE9462</a></p>	PRICE		1-9	\$128.20	10-24	\$121.79	25-49	\$115.38	50+	\$110.25	 <table border="1"> <thead> <tr> <th colspan="2">PRICE</th> </tr> </thead> <tbody> <tr> <td>1-24</td> <td>\$25.89</td> </tr> <tr> <td>25-49</td> <td>\$24.60</td> </tr> <tr> <td>50-99</td> <td>\$23.30</td> </tr> <tr> <td>100+</td> <td>\$22.27</td> </tr> </tbody> </table> <p>N Female to Mini UHF Male</p> <p>VSWR 1.5:1 to 2.5 GHz</p> <p>Model No: <a href="#">PE9183</a></p>	PRICE		1-24	\$25.89	25-49	\$24.60	50-99	\$23.30	100+	\$22.27	 <table border="1"> <thead> <tr> <th colspan="2">PRICE</th> </tr> </thead> <tbody> <tr> <td>1-9</td> <td>\$109.68</td> </tr> <tr> <td>10-24</td> <td>\$104.20</td> </tr> <tr> <td>25-49</td> <td>\$98.71</td> </tr> <tr> <td>50+</td> <td>\$94.32</td> </tr> </tbody> </table> <p>N Female to SC Male</p> <p>Model No: <a href="#">PE9277</a></p>	PRICE		1-9	\$109.68	10-24	\$104.20	25-49	\$98.71	50+	\$94.32
	PRICE																																																						
1-9	\$259.16																																																						
10-24	\$246.20																																																						
25-49	\$233.24																																																						
50+	\$222.88																																																						
PRICE																																																							
1-24	\$101.72																																																						
25-49	\$97.65																																																						
50-99	\$94.60																																																						
100+	\$92.57																																																						
PRICE																																																							
1-9	\$128.20																																																						
10-24	\$121.79																																																						
25-49	\$115.38																																																						
50+	\$110.25																																																						
PRICE																																																							
1-24	\$25.89																																																						
25-49	\$24.60																																																						
50-99	\$23.30																																																						
100+	\$22.27																																																						
PRICE																																																							
1-9	\$109.68																																																						
10-24	\$104.20																																																						
25-49	\$98.71																																																						
50+	\$94.32																																																						
3	 <table border="1"> <thead> <tr> <th colspan="2">PRICE</th> </tr> </thead> <tbody> <tr> <td>1-9</td> <td>\$110.13</td> </tr> <tr> <td>10-24</td> <td>\$104.62</td> </tr> <tr> <td>25-49</td> <td>\$99.12</td> </tr> <tr> <td>50+</td> <td>\$94.71</td> </tr> </tbody> </table> <p>N Female to SC Female</p> <p>VSWR 1.25:1 to 11 GHz</p> <p>Model No: <a href="#">PE9292</a></p>	PRICE		1-9	\$110.13	10-24	\$104.62	25-49	\$99.12	50+	\$94.71	 <table border="1"> <thead> <tr> <th colspan="2">PRICE</th> </tr> </thead> <tbody> <tr> <td>1-24</td> <td>\$52.30</td> </tr> <tr> <td>25-49</td> <td>\$49.69</td> </tr> <tr> <td>50-99</td> <td>\$47.07</td> </tr> <tr> <td>100+</td> <td>\$44.98</td> </tr> </tbody> </table> <p>Low PIM</p> <p>N Female to SMA Male</p> <p>VSWR 1.2:1 to 6 GHz</p> <p>Model No: <a href="#">PE91178</a></p>	PRICE		1-24	\$52.30	25-49	\$49.69	50-99	\$47.07	100+	\$44.98	 <table border="1"> <thead> <tr> <th colspan="2">PRICE</th> </tr> </thead> <tbody> <tr> <td>1-24</td> <td>\$71.18</td> </tr> <tr> <td>25-49</td> <td>\$67.62</td> </tr> <tr> <td>50-99</td> <td>\$64.06</td> </tr> <tr> <td>100+</td> <td>\$61.21</td> </tr> </tbody> </table> <p>N Female to SMB Plug</p> <p>Model No: <a href="#">PE9316</a></p>	PRICE		1-24	\$71.18	25-49	\$67.62	50-99	\$64.06	100+	\$61.21	 <table border="1"> <thead> <tr> <th colspan="2">PRICE</th> </tr> </thead> <tbody> <tr> <td>1-24</td> <td>\$71.18</td> </tr> <tr> <td>25-49</td> <td>\$67.62</td> </tr> <tr> <td>50-99</td> <td>\$64.06</td> </tr> <tr> <td>100+</td> <td>\$61.21</td> </tr> </tbody> </table> <p>N Female to SMB Jack</p> <p>Model No: <a href="#">PE9315</a></p>	PRICE		1-24	\$71.18	25-49	\$67.62	50-99	\$64.06	100+	\$61.21	 <table border="1"> <thead> <tr> <th colspan="2">PRICE</th> </tr> </thead> <tbody> <tr> <td>1-24</td> <td>\$103.17</td> </tr> <tr> <td>25-49</td> <td>\$98.01</td> </tr> <tr> <td>50-99</td> <td>\$92.85</td> </tr> <tr> <td>100+</td> <td>\$88.73</td> </tr> </tbody> </table> <p>N Female to SMC Plug</p> <p>Model No: <a href="#">PE9320</a></p>	PRICE		1-24	\$103.17	25-49	\$98.01	50-99	\$92.85	100+	\$88.73
	PRICE																																																						
1-9	\$110.13																																																						
10-24	\$104.62																																																						
25-49	\$99.12																																																						
50+	\$94.71																																																						
PRICE																																																							
1-24	\$52.30																																																						
25-49	\$49.69																																																						
50-99	\$47.07																																																						
100+	\$44.98																																																						
PRICE																																																							
1-24	\$71.18																																																						
25-49	\$67.62																																																						
50-99	\$64.06																																																						
100+	\$61.21																																																						
PRICE																																																							
1-24	\$71.18																																																						
25-49	\$67.62																																																						
50-99	\$64.06																																																						
100+	\$61.21																																																						
PRICE																																																							
1-24	\$103.17																																																						
25-49	\$98.01																																																						
50-99	\$92.85																																																						
100+	\$88.73																																																						
4	 <table border="1"> <thead> <tr> <th colspan="2">PRICE</th> </tr> </thead> <tbody> <tr> <td>1-24</td> <td>\$82.59</td> </tr> <tr> <td>25-49</td> <td>\$78.46</td> </tr> <tr> <td>50-99</td> <td>\$74.33</td> </tr> <tr> <td>100+</td> <td>\$71.03</td> </tr> </tbody> </table> <p>N Female to SMC Jack</p> <p>Model No: <a href="#">PE9319</a></p>	PRICE		1-24	\$82.59	25-49	\$78.46	50-99	\$74.33	100+	\$71.03	 <table border="1"> <thead> <tr> <th colspan="2">PRICE</th> </tr> </thead> <tbody> <tr> <td>1-24</td> <td>\$21.40</td> </tr> <tr> <td>25-49</td> <td>\$20.33</td> </tr> <tr> <td>50-99</td> <td>\$19.26</td> </tr> <tr> <td>100+</td> <td>\$18.40</td> </tr> </tbody> </table> <p>N Female to TNC Male</p> <p>VSWR 1.3:1 to 6 GHz</p> <p>Model No: <a href="#">PE9089</a></p>	PRICE		1-24	\$21.40	25-49	\$20.33	50-99	\$19.26	100+	\$18.40	 <table border="1"> <thead> <tr> <th colspan="2">PRICE</th> </tr> </thead> <tbody> <tr> <td>1-24</td> <td>\$139.01</td> </tr> <tr> <td>25-49</td> <td>\$129.28</td> </tr> <tr> <td>50-99</td> <td>\$119.55</td> </tr> <tr> <td>100+</td> <td>\$111.21</td> </tr> </tbody> </table> <p>PRECISION</p> <p>N Female to TNC Male</p> <p>VSWR 1.2:1 to 18 GHz</p> <p>Model No: <a href="#">PE91506</a></p>	PRICE		1-24	\$139.01	25-49	\$129.28	50-99	\$119.55	100+	\$111.21	 <table border="1"> <thead> <tr> <th colspan="2">PRICE</th> </tr> </thead> <tbody> <tr> <td>1-24</td> <td>\$63.98</td> </tr> <tr> <td>25-49</td> <td>\$60.78</td> </tr> <tr> <td>50-99</td> <td>\$57.58</td> </tr> <tr> <td>100+</td> <td>\$55.02</td> </tr> </tbody> </table> <p>N Female to TNC Male Right Angle</p> <p>VSWR 1.5:1 to 6 GHz</p> <p>Model No: <a href="#">PE9263</a></p>	PRICE		1-24	\$63.98	25-49	\$60.78	50-99	\$57.58	100+	\$55.02	 <table border="1"> <thead> <tr> <th colspan="2">PRICE</th> </tr> </thead> <tbody> <tr> <td>1-24</td> <td>\$25.83</td> </tr> <tr> <td>25-49</td> <td>\$24.54</td> </tr> <tr> <td>50-99</td> <td>\$23.25</td> </tr> <tr> <td>100+</td> <td>\$22.21</td> </tr> </tbody> </table> <p>N Female to TNC Female</p> <p>VSWR 1.5:1 to 3 GHz</p> <p>Model No: <a href="#">PE9131</a></p>	PRICE		1-24	\$25.83	25-49	\$24.54	50-99	\$23.25	100+	\$22.21
	PRICE																																																						
1-24	\$82.59																																																						
25-49	\$78.46																																																						
50-99	\$74.33																																																						
100+	\$71.03																																																						
PRICE																																																							
1-24	\$21.40																																																						
25-49	\$20.33																																																						
50-99	\$19.26																																																						
100+	\$18.40																																																						
PRICE																																																							
1-24	\$139.01																																																						
25-49	\$129.28																																																						
50-99	\$119.55																																																						
100+	\$111.21																																																						
PRICE																																																							
1-24	\$63.98																																																						
25-49	\$60.78																																																						
50-99	\$57.58																																																						
100+	\$55.02																																																						
PRICE																																																							
1-24	\$25.83																																																						
25-49	\$24.54																																																						
50-99	\$23.25																																																						
100+	\$22.21																																																						
5	 <table border="1"> <thead> <tr> <th colspan="2">PRICE</th> </tr> </thead> <tbody> <tr> <td>1-9</td> <td>\$186.29</td> </tr> <tr> <td>10-24</td> <td>\$176.98</td> </tr> <tr> <td>25-49</td> <td>\$167.66</td> </tr> <tr> <td>50+</td> <td>\$160.21</td> </tr> </tbody> </table> <p>PRECISION</p> <p>N Female to TNC Female</p> <p>VSWR 1.15:1 to 18 GHz</p> <p>Model No: <a href="#">PE9449</a></p>	PRICE		1-9	\$186.29	10-24	\$176.98	25-49	\$167.66	50+	\$160.21	 <table border="1"> <thead> <tr> <th colspan="2">PRICE</th> </tr> </thead> <tbody> <tr> <td>1-24</td> <td>\$87.30</td> </tr> <tr> <td>25-49</td> <td>\$82.94</td> </tr> <tr> <td>50-99</td> <td>\$78.57</td> </tr> <tr> <td>100+</td> <td>\$75.08</td> </tr> </tbody> </table> <p>N Female to TNC Female 4 Hole Flange-Mounting Hole A05</p> <p>Model No: <a href="#">PE9552</a></p>	PRICE		1-24	\$87.30	25-49	\$82.94	50-99	\$78.57	100+	\$75.08	 <table border="1"> <thead> <tr> <th colspan="2">PRICE</th> </tr> </thead> <tbody> <tr> <td>1-24</td> <td>\$49.21</td> </tr> <tr> <td>25-49</td> <td>\$46.75</td> </tr> <tr> <td>50-99</td> <td>\$44.29</td> </tr> <tr> <td>100+</td> <td>\$42.32</td> </tr> </tbody> </table> <p>N Female to TNC Female Bulkhead</p> <p>VSWR 1.35:1 to 10 GHz</p> <p>Model No: <a href="#">PE9482</a></p>	PRICE		1-24	\$49.21	25-49	\$46.75	50-99	\$44.29	100+	\$42.32	 <table border="1"> <thead> <tr> <th colspan="2">PRICE</th> </tr> </thead> <tbody> <tr> <td>1-9</td> <td>\$147.89</td> </tr> <tr> <td>10-24</td> <td>\$140.50</td> </tr> <tr> <td>25-49</td> <td>\$133.10</td> </tr> <tr> <td>50+</td> <td>\$127.19</td> </tr> </tbody> </table> <p>PRECISION</p> <p>N Female to TNC Female 4 Hole Flange-Mounting Hole A05</p> <p>VSWR 1.15:1 to 18 GHz</p> <p>Model No: <a href="#">PE9450</a></p>	PRICE		1-9	\$147.89	10-24	\$140.50	25-49	\$133.10	50+	\$127.19	 <table border="1"> <thead> <tr> <th colspan="2">PRICE</th> </tr> </thead> <tbody> <tr> <td>1-24</td> <td>\$31.14</td> </tr> <tr> <td>25-49</td> <td>\$29.58</td> </tr> <tr> <td>50-99</td> <td>\$28.03</td> </tr> <tr> <td>100+</td> <td>\$26.78</td> </tr> </tbody> </table> <p>N Female to UHF Male</p> <p>VSWR 1.3:1 to 300 MHz</p> <p>Model No: <a href="#">PE9112</a></p>	PRICE		1-24	\$31.14	25-49	\$29.58	50-99	\$28.03	100+	\$26.78
	PRICE																																																						
1-9	\$186.29																																																						
10-24	\$176.98																																																						
25-49	\$167.66																																																						
50+	\$160.21																																																						
PRICE																																																							
1-24	\$87.30																																																						
25-49	\$82.94																																																						
50-99	\$78.57																																																						
100+	\$75.08																																																						
PRICE																																																							
1-24	\$49.21																																																						
25-49	\$46.75																																																						
50-99	\$44.29																																																						
100+	\$42.32																																																						
PRICE																																																							
1-9	\$147.89																																																						
10-24	\$140.50																																																						
25-49	\$133.10																																																						
50+	\$127.19																																																						
PRICE																																																							
1-24	\$31.14																																																						
25-49	\$29.58																																																						
50-99	\$28.03																																																						
100+	\$26.78																																																						
6	 <table border="1"> <thead> <tr> <th colspan="2">PRICE</th> </tr> </thead> <tbody> <tr> <td>1-24</td> <td>\$37.07</td> </tr> <tr> <td>25-49</td> <td>\$35.22</td> </tr> <tr> <td>50-99</td> <td>\$33.36</td> </tr> <tr> <td>100+</td> <td>\$31.88</td> </tr> </tbody> </table> <p>N Female to UHF Female</p> <p>Max. Freq. 1,000 MHz</p> <p>Model No: <a href="#">PE9385</a></p>	PRICE		1-24	\$37.07	25-49	\$35.22	50-99	\$33.36	100+	\$31.88	<p><b>Reverse Polarity N Between Series</b></p> <p>→</p>		 <table border="1"> <thead> <tr> <th colspan="2">PRICE</th> </tr> </thead> <tbody> <tr> <td>1-24</td> <td>\$47.23</td> </tr> <tr> <td>25-49</td> <td>\$44.87</td> </tr> <tr> <td>50-99</td> <td>\$42.51</td> </tr> <tr> <td>100+</td> <td>\$40.62</td> </tr> </tbody> </table> <p>N Male to Rev. Pol. TNC Female</p> <p>VSWR 1.3:1 to 6 GHz</p> <p>Model No: <a href="#">PE9730</a></p>	PRICE		1-24	\$47.23	25-49	\$44.87	50-99	\$42.51	100+	\$40.62	 <table border="1"> <thead> <tr> <th colspan="2">PRICE</th> </tr> </thead> <tbody> <tr> <td>1-24</td> <td>\$47.06</td> </tr> <tr> <td>25-49</td> <td>\$44.71</td> </tr> <tr> <td>50-99</td> <td>\$42.35</td> </tr> <tr> <td>100+</td> <td>\$40.47</td> </tr> </tbody> </table> <p>N Female to Rev. Pol. TNC Male</p> <p>Model No: <a href="#">PE9731</a></p>	PRICE		1-24	\$47.06	25-49	\$44.71	50-99	\$42.35	100+	\$40.47	<p><b>QMA In-Series</b></p> <p>→</p>																			
	PRICE																																																						
1-24	\$37.07																																																						
25-49	\$35.22																																																						
50-99	\$33.36																																																						
100+	\$31.88																																																						
PRICE																																																							
1-24	\$47.23																																																						
25-49	\$44.87																																																						
50-99	\$42.51																																																						
100+	\$40.62																																																						
PRICE																																																							
1-24	\$47.06																																																						
25-49	\$44.71																																																						
50-99	\$42.35																																																						
100+	\$40.47																																																						
7	 <table border="1"> <thead> <tr> <th colspan="2">PRICE</th> </tr> </thead> <tbody> <tr> <td>1-24</td> <td>\$55.22</td> </tr> <tr> <td>25-49</td> <td>\$52.46</td> </tr> <tr> <td>50-99</td> <td>\$49.70</td> </tr> <tr> <td>100+</td> <td>\$47.49</td> </tr> </tbody> </table> <p>Snap-On QMA Male to Snap-On QMA Male</p> <p>VSWR 1.08:1 to 6 GHz</p> <p>Model No: <a href="#">PE91341</a></p>	PRICE		1-24	\$55.22	25-49	\$52.46	50-99	\$49.70	100+	\$47.49	 <table border="1"> <thead> <tr> <th colspan="2">PRICE</th> </tr> </thead> <tbody> <tr> <td>1-24</td> <td>\$33.20</td> </tr> <tr> <td>25-49</td> <td>\$31.54</td> </tr> <tr> <td>50-99</td> <td>\$29.88</td> </tr> <tr> <td>100+</td> <td>\$28.55</td> </tr> </tbody> </table> <p>Snap-On QMA Male to Snap-On QMA Female</p> <p>VSWR 1.12:1 to 6 GHz</p> <p>Model No: <a href="#">PE91342</a></p>	PRICE		1-24	\$33.20	25-49	\$31.54	50-99	\$29.88	100+	\$28.55	 <table border="1"> <thead> <tr> <th colspan="2">PRICE</th> </tr> </thead> <tbody> <tr> <td>1-9</td> <td>\$162.74</td> </tr> <tr> <td>10-24</td> <td>\$154.60</td> </tr> <tr> <td>25-49</td> <td>\$146.47</td> </tr> <tr> <td>NEW 50+</td> <td>\$139.96</td> </tr> </tbody> </table> <p>Snap-On QMA Female to Snap-On QMA Female</p> <p>VSWR 1.08:1 to 6 GHz</p> <p>Model No: <a href="#">PE91343</a></p>	PRICE		1-9	\$162.74	10-24	\$154.60	25-49	\$146.47	NEW 50+	\$139.96	<p><b>QMA Between Series</b></p> <p>→</p>		 <table border="1"> <thead> <tr> <th colspan="2">PRICE</th> </tr> </thead> <tbody> <tr> <td>1-9</td> <td>\$179.20</td> </tr> <tr> <td>10-24</td> <td>\$170.24</td> </tr> <tr> <td>25-49</td> <td>\$161.28</td> </tr> <tr> <td>50+</td> <td>\$154.11</td> </tr> </tbody> </table> <p>Snap-On QMA Male to Snap-On SMA Male</p> <p>VSWR 1.18:1 to 6 GHz</p> <p>Model No: <a href="#">PE91344</a></p>	PRICE		1-9	\$179.20	10-24	\$170.24	25-49	\$161.28	50+	\$154.11									
	PRICE																																																						
1-24	\$55.22																																																						
25-49	\$52.46																																																						
50-99	\$49.70																																																						
100+	\$47.49																																																						
PRICE																																																							
1-24	\$33.20																																																						
25-49	\$31.54																																																						
50-99	\$29.88																																																						
100+	\$28.55																																																						
PRICE																																																							
1-9	\$162.74																																																						
10-24	\$154.60																																																						
25-49	\$146.47																																																						
NEW 50+	\$139.96																																																						
PRICE																																																							
1-9	\$179.20																																																						
10-24	\$170.24																																																						
25-49	\$161.28																																																						
50+	\$154.11																																																						

# ADAPTERS

See Adapter Locator on Pages 8-13

See Page 369 for Mounting Holes

Adapters

See Our Website For Current Pricing & Real-Time Stock Availability!

	A	B	C	D	E																																																		
1	 <table border="1"> <thead> <tr> <th colspan="2">PRICE</th> </tr> </thead> <tbody> <tr> <td>1-24</td> <td>\$63.66</td> </tr> <tr> <td>25-49</td> <td>\$60.48</td> </tr> <tr> <td>50-99</td> <td>\$57.29</td> </tr> <tr> <td>NEW 100+</td> <td>\$54.75</td> </tr> </tbody> </table> <p>Snap-On QMA Male to SMA Female VSWR 1.18:1 to 6 GHz Model No: <a href="#">PE91345</a></p>	PRICE		1-24	\$63.66	25-49	\$60.48	50-99	\$57.29	NEW 100+	\$54.75	 <table border="1"> <thead> <tr> <th colspan="2">PRICE</th> </tr> </thead> <tbody> <tr> <td>1-24</td> <td>\$51.11</td> </tr> <tr> <td>25-49</td> <td>\$48.55</td> </tr> <tr> <td>50-99</td> <td>\$46.00</td> </tr> <tr> <td>NEW 100+</td> <td>\$43.95</td> </tr> </tbody> </table> <p>Snap-On QMA Female to SMA Male VSWR 1.18:1 to 6 GHz Model No: <a href="#">PE91346</a></p>	PRICE		1-24	\$51.11	25-49	\$48.55	50-99	\$46.00	NEW 100+	\$43.95	 <table border="1"> <thead> <tr> <th colspan="2">PRICE</th> </tr> </thead> <tbody> <tr> <td>1-9</td> <td>\$109.94</td> </tr> <tr> <td>10-24</td> <td>\$104.44</td> </tr> <tr> <td>25-49</td> <td>\$98.95</td> </tr> <tr> <td>NEW 50+</td> <td>\$94.55</td> </tr> </tbody> </table> <p>Snap-On QMA Female to Snap-On SMA Female VSWR 1.18:1 to 6 GHz Model No: <a href="#">PE91347</a></p>	PRICE		1-9	\$109.94	10-24	\$104.44	25-49	\$98.95	NEW 50+	\$94.55	<p style="text-align: center;"><b>SC In-Series</b></p> <p style="text-align: center;">→</p>	 <table border="1"> <thead> <tr> <th colspan="2">PRICE</th> </tr> </thead> <tbody> <tr> <td>1-9</td> <td>\$112.00</td> </tr> <tr> <td>10-24</td> <td>\$106.40</td> </tr> <tr> <td>25-49</td> <td>\$100.80</td> </tr> <tr> <td>50+</td> <td>\$96.32</td> </tr> </tbody> </table> <p>SC Male to SC Male Model No: <a href="#">PE9403</a></p>	PRICE		1-9	\$112.00	10-24	\$106.40	25-49	\$100.80	50+	\$96.32										
	PRICE																																																						
1-24	\$63.66																																																						
25-49	\$60.48																																																						
50-99	\$57.29																																																						
NEW 100+	\$54.75																																																						
PRICE																																																							
1-24	\$51.11																																																						
25-49	\$48.55																																																						
50-99	\$46.00																																																						
NEW 100+	\$43.95																																																						
PRICE																																																							
1-9	\$109.94																																																						
10-24	\$104.44																																																						
25-49	\$98.95																																																						
NEW 50+	\$94.55																																																						
PRICE																																																							
1-9	\$112.00																																																						
10-24	\$106.40																																																						
25-49	\$100.80																																																						
50+	\$96.32																																																						
2	 <table border="1"> <thead> <tr> <th colspan="2">PRICE</th> </tr> </thead> <tbody> <tr> <td>1-24</td> <td>\$82.33</td> </tr> <tr> <td>25-49</td> <td>\$78.21</td> </tr> <tr> <td>50-99</td> <td>\$74.10</td> </tr> <tr> <td>100+</td> <td>\$70.80</td> </tr> </tbody> </table> <p>SC Male to SC Female Model No: <a href="#">PE9572</a></p>	PRICE		1-24	\$82.33	25-49	\$78.21	50-99	\$74.10	100+	\$70.80	 <table border="1"> <thead> <tr> <th colspan="2">PRICE</th> </tr> </thead> <tbody> <tr> <td>1-9</td> <td>\$162.12</td> </tr> <tr> <td>10-24</td> <td>\$154.01</td> </tr> <tr> <td>25-49</td> <td>\$145.91</td> </tr> <tr> <td>50+</td> <td>\$139.42</td> </tr> </tbody> </table> <p>SC Male to SC Female Right Angle Model No: <a href="#">PE9405</a></p>	PRICE		1-9	\$162.12	10-24	\$154.01	25-49	\$145.91	50+	\$139.42	 <table border="1"> <thead> <tr> <th colspan="2">PRICE</th> </tr> </thead> <tbody> <tr> <td>1-9</td> <td>\$266.89</td> </tr> <tr> <td>10-24</td> <td>\$253.55</td> </tr> <tr> <td>25-49</td> <td>\$240.20</td> </tr> <tr> <td>50+</td> <td>\$229.53</td> </tr> </tbody> </table> <p>SC Female to SC Male Tee Model No: <a href="#">PE9225</a></p>	PRICE		1-9	\$266.89	10-24	\$253.55	25-49	\$240.20	50+	\$229.53	 <table border="1"> <thead> <tr> <th colspan="2">PRICE</th> </tr> </thead> <tbody> <tr> <td>1-9</td> <td>\$117.84</td> </tr> <tr> <td>10-24</td> <td>\$111.95</td> </tr> <tr> <td>25-49</td> <td>\$106.06</td> </tr> <tr> <td>50+</td> <td>\$101.34</td> </tr> </tbody> </table> <p>SC Female to SC Female Model No: <a href="#">PE9404</a></p>	PRICE		1-9	\$117.84	10-24	\$111.95	25-49	\$106.06	50+	\$101.34	 <table border="1"> <thead> <tr> <th colspan="2">PRICE</th> </tr> </thead> <tbody> <tr> <td>1-9</td> <td>\$151.55</td> </tr> <tr> <td>10-24</td> <td>\$143.97</td> </tr> <tr> <td>25-49</td> <td>\$136.40</td> </tr> <tr> <td>50+</td> <td>\$130.33</td> </tr> </tbody> </table> <p>SC Female to SC Female Bulkhead Model No: <a href="#">PE9573</a></p>	PRICE		1-9	\$151.55	10-24	\$143.97	25-49	\$136.40	50+	\$130.33
	PRICE																																																						
1-24	\$82.33																																																						
25-49	\$78.21																																																						
50-99	\$74.10																																																						
100+	\$70.80																																																						
PRICE																																																							
1-9	\$162.12																																																						
10-24	\$154.01																																																						
25-49	\$145.91																																																						
50+	\$139.42																																																						
PRICE																																																							
1-9	\$266.89																																																						
10-24	\$253.55																																																						
25-49	\$240.20																																																						
50+	\$229.53																																																						
PRICE																																																							
1-9	\$117.84																																																						
10-24	\$111.95																																																						
25-49	\$106.06																																																						
50+	\$101.34																																																						
PRICE																																																							
1-9	\$151.55																																																						
10-24	\$143.97																																																						
25-49	\$136.40																																																						
50+	\$130.33																																																						
3	<p style="text-align: center;"><b>SC Between Series</b></p> <p style="text-align: center;">→</p>	 <table border="1"> <thead> <tr> <th colspan="2">PRICE</th> </tr> </thead> <tbody> <tr> <td>1-24</td> <td>\$55.48</td> </tr> <tr> <td>25-49</td> <td>\$52.71</td> </tr> <tr> <td>50-99</td> <td>\$49.93</td> </tr> <tr> <td>100+</td> <td>\$47.71</td> </tr> </tbody> </table> <p>SC Male to BNC Male Model No: <a href="#">PE9568</a></p>	PRICE		1-24	\$55.48	25-49	\$52.71	50-99	\$49.93	100+	\$47.71	 <table border="1"> <thead> <tr> <th colspan="2">PRICE</th> </tr> </thead> <tbody> <tr> <td>1-9</td> <td>\$191.22</td> </tr> <tr> <td>10-24</td> <td>\$181.66</td> </tr> <tr> <td>25-49</td> <td>\$172.10</td> </tr> <tr> <td>50+</td> <td>\$164.45</td> </tr> </tbody> </table> <p>SC Male to BNC Female Model No: <a href="#">PE9200</a></p>	PRICE		1-9	\$191.22	10-24	\$181.66	25-49	\$172.10	50+	\$164.45	 <table border="1"> <thead> <tr> <th colspan="2">PRICE</th> </tr> </thead> <tbody> <tr> <td>1-24</td> <td>\$74.47</td> </tr> <tr> <td>25-49</td> <td>\$70.75</td> </tr> <tr> <td>50-99</td> <td>\$67.02</td> </tr> <tr> <td>100+</td> <td>\$64.04</td> </tr> </tbody> </table> <p>SC Female to BNC Female Model No: <a href="#">PE9571</a></p>	PRICE		1-24	\$74.47	25-49	\$70.75	50-99	\$67.02	100+	\$64.04	<p style="text-align: center;"><b>SHV In-Series</b></p> <p style="text-align: center;">→</p>																				
	PRICE																																																						
1-24	\$55.48																																																						
25-49	\$52.71																																																						
50-99	\$49.93																																																						
100+	\$47.71																																																						
PRICE																																																							
1-9	\$191.22																																																						
10-24	\$181.66																																																						
25-49	\$172.10																																																						
50+	\$164.45																																																						
PRICE																																																							
1-24	\$74.47																																																						
25-49	\$70.75																																																						
50-99	\$67.02																																																						
100+	\$64.04																																																						
4	 <table border="1"> <thead> <tr> <th colspan="2">PRICE</th> </tr> </thead> <tbody> <tr> <td>1-9</td> <td>\$127.63</td> </tr> <tr> <td>10-24</td> <td>\$121.25</td> </tr> <tr> <td>25-49</td> <td>\$114.87</td> </tr> <tr> <td>50+</td> <td>\$109.76</td> </tr> </tbody> </table> <p>SHV Plug to SHV Jack Model No: <a href="#">PE9749</a></p>	PRICE		1-9	\$127.63	10-24	\$121.25	25-49	\$114.87	50+	\$109.76	 <table border="1"> <thead> <tr> <th colspan="2">PRICE</th> </tr> </thead> <tbody> <tr> <td>1-24</td> <td>\$88.28</td> </tr> <tr> <td>25-49</td> <td>\$83.87</td> </tr> <tr> <td>50-99</td> <td>\$79.45</td> </tr> <tr> <td>100+</td> <td>\$75.92</td> </tr> </tbody> </table> <p>SHV Plug to SHV Jack Right Angle Model No: <a href="#">PE9338</a></p>	PRICE		1-24	\$88.28	25-49	\$83.87	50-99	\$79.45	100+	\$75.92	 <table border="1"> <thead> <tr> <th colspan="2">PRICE</th> </tr> </thead> <tbody> <tr> <td>1-24</td> <td>\$102.79</td> </tr> <tr> <td>25-49</td> <td>\$97.65</td> </tr> <tr> <td>50-99</td> <td>\$92.51</td> </tr> <tr> <td>100+</td> <td>\$88.40</td> </tr> </tbody> </table> <p>SHV Jack to SHV Plug Tee VSWR 1.2:1 to 300 MHz Model No: <a href="#">PE9249</a></p>	PRICE		1-24	\$102.79	25-49	\$97.65	50-99	\$92.51	100+	\$88.40	 <table border="1"> <thead> <tr> <th colspan="2">PRICE</th> </tr> </thead> <tbody> <tr> <td>1-24</td> <td>\$44.83</td> </tr> <tr> <td>25-49</td> <td>\$42.59</td> </tr> <tr> <td>50-99</td> <td>\$40.35</td> </tr> <tr> <td>100+</td> <td>\$38.55</td> </tr> </tbody> </table> <p>SHV Jack to SHV Jack VSWR 1.3:1 to 300 MHz Model No: <a href="#">PE9337</a></p>	PRICE		1-24	\$44.83	25-49	\$42.59	50-99	\$40.35	100+	\$38.55	 <table border="1"> <thead> <tr> <th colspan="2">PRICE</th> </tr> </thead> <tbody> <tr> <td>1-24</td> <td>\$88.25</td> </tr> <tr> <td>25-49</td> <td>\$83.84</td> </tr> <tr> <td>50-99</td> <td>\$79.43</td> </tr> <tr> <td>100+</td> <td>\$75.90</td> </tr> </tbody> </table> <p>SHV Jack to SHV Jack Bulkhead Max. Freq. 300 MHz Model No: <a href="#">PE9336</a></p>	PRICE		1-24	\$88.25	25-49	\$83.84	50-99	\$79.43	100+	\$75.90
	PRICE																																																						
1-9	\$127.63																																																						
10-24	\$121.25																																																						
25-49	\$114.87																																																						
50+	\$109.76																																																						
PRICE																																																							
1-24	\$88.28																																																						
25-49	\$83.87																																																						
50-99	\$79.45																																																						
100+	\$75.92																																																						
PRICE																																																							
1-24	\$102.79																																																						
25-49	\$97.65																																																						
50-99	\$92.51																																																						
100+	\$88.40																																																						
PRICE																																																							
1-24	\$44.83																																																						
25-49	\$42.59																																																						
50-99	\$40.35																																																						
100+	\$38.55																																																						
PRICE																																																							
1-24	\$88.25																																																						
25-49	\$83.84																																																						
50-99	\$79.43																																																						
100+	\$75.90																																																						
5	<p style="text-align: center;"><b>SMA In-Series</b></p> <p style="text-align: center;">→</p>	 <table border="1"> <thead> <tr> <th colspan="2">PRICE</th> </tr> </thead> <tbody> <tr> <td>1-24</td> <td>\$19.29</td> </tr> <tr> <td>25-49</td> <td>\$18.33</td> </tr> <tr> <td>50-99</td> <td>\$17.36</td> </tr> <tr> <td>100+</td> <td>\$16.59</td> </tr> </tbody> </table> <p>SMA Male to SMA Male VSWR 1.23:1 to 18 GHz Model No: <a href="#">PE91135</a></p>	PRICE		1-24	\$19.29	25-49	\$18.33	50-99	\$17.36	100+	\$16.59	 <table border="1"> <thead> <tr> <th colspan="2">PRICE</th> </tr> </thead> <tbody> <tr> <td>1-24</td> <td>\$72.63</td> </tr> <tr> <td>25-49</td> <td>\$69.00</td> </tr> <tr> <td>50-99</td> <td>\$65.37</td> </tr> <tr> <td>PRECISION 100+</td> <td>\$62.46</td> </tr> </tbody> </table> <p>SMA Male to SMA Male VSWR 1.2:1 to 27 GHz Model No: <a href="#">PE9505</a></p>	PRICE		1-24	\$72.63	25-49	\$69.00	50-99	\$65.37	PRECISION 100+	\$62.46	 <table border="1"> <thead> <tr> <th colspan="2">PRICE</th> </tr> </thead> <tbody> <tr> <td>1-9</td> <td>Call</td> </tr> <tr> <td>10-24</td> <td>Call</td> </tr> <tr> <td>25-49</td> <td>Call</td> </tr> <tr> <td>50+</td> <td>Call</td> </tr> </tbody> </table> <p>SMA Male to SMA Male Radius Right Angle VSWR 1.25:1 to 18 GHz Model No: <a href="#">PE91327</a></p>	PRICE		1-9	Call	10-24	Call	25-49	Call	50+	Call	 <table border="1"> <thead> <tr> <th colspan="2">PRICE</th> </tr> </thead> <tbody> <tr> <td>1-9</td> <td>Call</td> </tr> <tr> <td>10-24</td> <td>Call</td> </tr> <tr> <td>25-49</td> <td>Call</td> </tr> <tr> <td>PRECISION NEW 50+</td> <td>Call</td> </tr> </tbody> </table> <p>SMA Male to SMA Male Radius Right Angle VSWR 1.25:1 to 18 GHz Model No: <a href="#">PE91458</a></p>	PRICE		1-9	Call	10-24	Call	25-49	Call	PRECISION NEW 50+	Call										
	PRICE																																																						
1-24	\$19.29																																																						
25-49	\$18.33																																																						
50-99	\$17.36																																																						
100+	\$16.59																																																						
PRICE																																																							
1-24	\$72.63																																																						
25-49	\$69.00																																																						
50-99	\$65.37																																																						
PRECISION 100+	\$62.46																																																						
PRICE																																																							
1-9	Call																																																						
10-24	Call																																																						
25-49	Call																																																						
50+	Call																																																						
PRICE																																																							
1-9	Call																																																						
10-24	Call																																																						
25-49	Call																																																						
PRECISION NEW 50+	Call																																																						
6	 <table border="1"> <thead> <tr> <th colspan="2">PRICE</th> </tr> </thead> <tbody> <tr> <td>1-24</td> <td>\$53.31</td> </tr> <tr> <td>25-49</td> <td>\$50.64</td> </tr> <tr> <td>50-99</td> <td>\$47.98</td> </tr> <tr> <td>100+</td> <td>\$45.85</td> </tr> </tbody> </table> <p>SMA Male to SMA Male Right Angle VSWR 1.5:1 to 12.4 GHz Model No: <a href="#">PE9418</a></p>	PRICE		1-24	\$53.31	25-49	\$50.64	50-99	\$47.98	100+	\$45.85	 <table border="1"> <thead> <tr> <th colspan="2">PRICE</th> </tr> </thead> <tbody> <tr> <td>1-24</td> <td>\$76.60</td> </tr> <tr> <td>25-49</td> <td>\$72.77</td> </tr> <tr> <td>50-99</td> <td>\$68.94</td> </tr> <tr> <td>100+</td> <td>\$65.88</td> </tr> </tbody> </table> <p>SMA Male to SMA Male Tee Model No: <a href="#">PE9379</a></p>	PRICE		1-24	\$76.60	25-49	\$72.77	50-99	\$68.94	100+	\$65.88	 <table border="1"> <thead> <tr> <th colspan="2">PRICE</th> </tr> </thead> <tbody> <tr> <td>1-24</td> <td>\$100.21</td> </tr> <tr> <td>25-49</td> <td>\$95.20</td> </tr> <tr> <td>50-99</td> <td>\$90.19</td> </tr> <tr> <td>PRECISION 100+</td> <td>\$86.18</td> </tr> </tbody> </table> <p>SMA Male to SMA Male Miter Right Angle VSWR 1.15:1 to 27 GHz Model No: <a href="#">PE91151</a></p>	PRICE		1-24	\$100.21	25-49	\$95.20	50-99	\$90.19	PRECISION 100+	\$86.18	 <table border="1"> <thead> <tr> <th colspan="2">PRICE</th> </tr> </thead> <tbody> <tr> <td>1-24</td> <td>\$94.56</td> </tr> <tr> <td>25-49</td> <td>\$89.83</td> </tr> <tr> <td>50-99</td> <td>\$85.10</td> </tr> <tr> <td>100+</td> <td>\$81.32</td> </tr> </tbody> </table> <p>SMA Male to SMA Male Miter Right Angle VSWR 1.35:1 to 27 GHz Model No: <a href="#">PE9642</a></p>	PRICE		1-24	\$94.56	25-49	\$89.83	50-99	\$85.10	100+	\$81.32	 <table border="1"> <thead> <tr> <th colspan="2">PRICE</th> </tr> </thead> <tbody> <tr> <td>1-9</td> <td>\$218.37</td> </tr> <tr> <td>10-24</td> <td>\$209.64</td> </tr> <tr> <td>25-49</td> <td>\$203.08</td> </tr> <tr> <td>50+</td> <td>\$198.72</td> </tr> </tbody> </table> <p>SMA Male to SMA Male 4 Hole Flange-Mounting Hole A01 VSWR 1.2:1 to 18 GHz Model No: <a href="#">PE9669</a></p>	PRICE		1-9	\$218.37	10-24	\$209.64	25-49	\$203.08	50+	\$198.72
	PRICE																																																						
1-24	\$53.31																																																						
25-49	\$50.64																																																						
50-99	\$47.98																																																						
100+	\$45.85																																																						
PRICE																																																							
1-24	\$76.60																																																						
25-49	\$72.77																																																						
50-99	\$68.94																																																						
100+	\$65.88																																																						
PRICE																																																							
1-24	\$100.21																																																						
25-49	\$95.20																																																						
50-99	\$90.19																																																						
PRECISION 100+	\$86.18																																																						
PRICE																																																							
1-24	\$94.56																																																						
25-49	\$89.83																																																						
50-99	\$85.10																																																						
100+	\$81.32																																																						
PRICE																																																							
1-9	\$218.37																																																						
10-24	\$209.64																																																						
25-49	\$203.08																																																						
50+	\$198.72																																																						
7	 <table border="1"> <thead> <tr> <th colspan="2">PRICE</th> </tr> </thead> <tbody> <tr> <td>1-24</td> <td>\$26.94</td> </tr> <tr> <td>25-49</td> <td>\$25.59</td> </tr> <tr> <td>50-99</td> <td>\$24.25</td> </tr> <tr> <td>100+</td> <td>\$23.17</td> </tr> </tbody> </table> <p>SMA Male to SMA Female VSWR 1.25:1 to 18 GHz Model No: <a href="#">PE9103</a></p>	PRICE		1-24	\$26.94	25-49	\$25.59	50-99	\$24.25	100+	\$23.17	 <table border="1"> <thead> <tr> <th colspan="2">PRICE</th> </tr> </thead> <tbody> <tr> <td>1-24</td> <td>\$31.40</td> </tr> <tr> <td>25-49</td> <td>\$29.83</td> </tr> <tr> <td>50-99</td> <td>\$28.26</td> </tr> <tr> <td>100+</td> <td>\$27.00</td> </tr> </tbody> </table> <p>QD SMA Male to SMA Female Model No: <a href="#">PE9546</a></p>	PRICE		1-24	\$31.40	25-49	\$29.83	50-99	\$28.26	100+	\$27.00	 <table border="1"> <thead> <tr> <th colspan="2">PRICE</th> </tr> </thead> <tbody> <tr> <td>1-24</td> <td>\$52.31</td> </tr> <tr> <td>25-49</td> <td>\$49.69</td> </tr> <tr> <td>50-99</td> <td>\$47.08</td> </tr> <tr> <td>PRECISION 100+</td> <td>\$44.99</td> </tr> </tbody> </table> <p>SMA Male to SMA Female VSWR 1.2:1 to 18 GHz Model No: <a href="#">PE9694</a></p>	PRICE		1-24	\$52.31	25-49	\$49.69	50-99	\$47.08	PRECISION 100+	\$44.99	 <table border="1"> <thead> <tr> <th colspan="2">PRICE</th> </tr> </thead> <tbody> <tr> <td>1-9</td> <td>\$149.17</td> </tr> <tr> <td>10-24</td> <td>\$141.71</td> </tr> <tr> <td>25-49</td> <td>\$134.25</td> </tr> <tr> <td>PRECISION 50+</td> <td>\$128.29</td> </tr> </tbody> </table> <p>QD SMA Male to SMA Female VSWR 1.14:1 to 18 GHz Model No: <a href="#">PE9774</a></p>	PRICE		1-9	\$149.17	10-24	\$141.71	25-49	\$134.25	PRECISION 50+	\$128.29	 <table border="1"> <thead> <tr> <th colspan="2">PRICE</th> </tr> </thead> <tbody> <tr> <td>1-24</td> <td>\$58.00</td> </tr> <tr> <td>25-49</td> <td>\$53.94</td> </tr> <tr> <td>50-99</td> <td>\$49.88</td> </tr> <tr> <td>100+</td> <td>\$46.40</td> </tr> </tbody> </table> <p>SMA Male to SMA Female Radius Right Angle VSWR 1.2:1 to 18 GHz Model No: <a href="#">PE91492</a></p>	PRICE		1-24	\$58.00	25-49	\$53.94	50-99	\$49.88	100+	\$46.40
	PRICE																																																						
1-24	\$26.94																																																						
25-49	\$25.59																																																						
50-99	\$24.25																																																						
100+	\$23.17																																																						
PRICE																																																							
1-24	\$31.40																																																						
25-49	\$29.83																																																						
50-99	\$28.26																																																						
100+	\$27.00																																																						
PRICE																																																							
1-24	\$52.31																																																						
25-49	\$49.69																																																						
50-99	\$47.08																																																						
PRECISION 100+	\$44.99																																																						
PRICE																																																							
1-9	\$149.17																																																						
10-24	\$141.71																																																						
25-49	\$134.25																																																						
PRECISION 50+	\$128.29																																																						
PRICE																																																							
1-24	\$58.00																																																						
25-49	\$53.94																																																						
50-99	\$49.88																																																						
100+	\$46.40																																																						



Technical Support  
+1 (949) 261-1920



Same-Day Shipping,  
Even Custom Cable Assemblies

# ADAPTERS

See Adapter Locator on Pages 8-13

See Page 369 for Mounting Holes

Adapters

See Our Website For Current Pricing & Real-Time Stock Availability!

	A	B	C	D	E																																																		
1	 <table border="1"> <thead> <tr> <th colspan="2">PRICE</th> </tr> </thead> <tbody> <tr> <td>1-24</td> <td>\$61.00</td> </tr> <tr> <td>25-49</td> <td>\$56.73</td> </tr> <tr> <td>50-99</td> <td>\$52.46</td> </tr> <tr> <td>100+</td> <td>\$48.80</td> </tr> </tbody> </table> <p><b>SMA Male to SMA Female Radius Right Angle</b> VSWR 1.2:1 to 18 GHz</p> <p>Model No: <a href="#">PE91493</a></p>	PRICE		1-24	\$61.00	25-49	\$56.73	50-99	\$52.46	100+	\$48.80	 <table border="1"> <thead> <tr> <th colspan="2">PRICE</th> </tr> </thead> <tbody> <tr> <td>1-24</td> <td>\$87.64</td> </tr> <tr> <td>25-49</td> <td>\$84.13</td> </tr> <tr> <td>50-99</td> <td>\$81.51</td> </tr> <tr> <td>100+</td> <td>\$79.75</td> </tr> </tbody> </table> <p><b>SMA Male to SMA Female Radius Right Angle</b> VSWR 1.25:1 to 18 GHz</p> <p>Model No: <a href="#">PE91155</a></p>	PRICE		1-24	\$87.64	25-49	\$84.13	50-99	\$81.51	100+	\$79.75	 <table border="1"> <thead> <tr> <th colspan="2">PRICE</th> </tr> </thead> <tbody> <tr> <td>1-24</td> <td>\$76.52</td> </tr> <tr> <td>25-49</td> <td>\$72.69</td> </tr> <tr> <td>50-99</td> <td>\$68.87</td> </tr> <tr> <td>100+</td> <td>\$65.81</td> </tr> </tbody> </table> <p><b>SMA Male to SMA Female Radius Right Angle</b> VSWR 1.55:1 to 26.5 GHz</p> <p>Model No: <a href="#">PE91222</a></p>	PRICE		1-24	\$76.52	25-49	\$72.69	50-99	\$68.87	100+	\$65.81	 <table border="1"> <thead> <tr> <th colspan="2">PRICE</th> </tr> </thead> <tbody> <tr> <td>1-24</td> <td>\$31.17</td> </tr> <tr> <td>25-49</td> <td>\$29.61</td> </tr> <tr> <td>50-99</td> <td>\$28.05</td> </tr> <tr> <td>100+</td> <td>\$26.81</td> </tr> </tbody> </table> <p><b>SMA Male to SMA Female Right Angle</b> VSWR 1.23:1 to 12.4 GHz</p> <p>Model No: <a href="#">PE9068</a></p>	PRICE		1-24	\$31.17	25-49	\$29.61	50-99	\$28.05	100+	\$26.81	 <table border="1"> <thead> <tr> <th colspan="2">PRICE</th> </tr> </thead> <tbody> <tr> <td>1-24</td> <td>\$98.04</td> </tr> <tr> <td>25-49</td> <td>\$93.14</td> </tr> <tr> <td>50-99</td> <td>\$88.24</td> </tr> <tr> <td>100+</td> <td>\$84.31</td> </tr> </tbody> </table> <p>PRECISION <b>SMA Male to SMA Female 45 Degree Right</b> VSWR 1.3:1 to 27 GHz</p> <p>Model No: <a href="#">PE91332</a></p>	PRICE		1-24	\$98.04	25-49	\$93.14	50-99	\$88.24	100+	\$84.31
	PRICE																																																						
1-24	\$61.00																																																						
25-49	\$56.73																																																						
50-99	\$52.46																																																						
100+	\$48.80																																																						
PRICE																																																							
1-24	\$87.64																																																						
25-49	\$84.13																																																						
50-99	\$81.51																																																						
100+	\$79.75																																																						
PRICE																																																							
1-24	\$76.52																																																						
25-49	\$72.69																																																						
50-99	\$68.87																																																						
100+	\$65.81																																																						
PRICE																																																							
1-24	\$31.17																																																						
25-49	\$29.61																																																						
50-99	\$28.05																																																						
100+	\$26.81																																																						
PRICE																																																							
1-24	\$98.04																																																						
25-49	\$93.14																																																						
50-99	\$88.24																																																						
100+	\$84.31																																																						
2	 <table border="1"> <thead> <tr> <th colspan="2">PRICE</th> </tr> </thead> <tbody> <tr> <td>1-24</td> <td>\$84.04</td> </tr> <tr> <td>25-49</td> <td>\$79.84</td> </tr> <tr> <td>50-99</td> <td>\$75.64</td> </tr> <tr> <td>100+</td> <td>\$72.27</td> </tr> </tbody> </table> <p><b>SMA Male to SMA Female Tee</b> VSWR 2.25:1 to 6 GHz</p> <p>Model No: <a href="#">PE9247</a></p>	PRICE		1-24	\$84.04	25-49	\$79.84	50-99	\$75.64	100+	\$72.27	 <table border="1"> <thead> <tr> <th colspan="2">PRICE</th> </tr> </thead> <tbody> <tr> <td>1-24</td> <td>\$76.80</td> </tr> <tr> <td>25-49</td> <td>\$72.96</td> </tr> <tr> <td>50-99</td> <td>\$69.12</td> </tr> <tr> <td>100+</td> <td>\$66.05</td> </tr> </tbody> </table> <p><b>SMA Male to SMA Female Miter Right Angle</b> VSWR 1.35:1 to 27 GHz</p> <p>Model No: <a href="#">PE91149</a></p>	PRICE		1-24	\$76.80	25-49	\$72.96	50-99	\$69.12	100+	\$66.05	 <table border="1"> <thead> <tr> <th colspan="2">PRICE</th> </tr> </thead> <tbody> <tr> <td>1-24</td> <td>\$83.79</td> </tr> <tr> <td>25-49</td> <td>\$77.92</td> </tr> <tr> <td>50-99</td> <td>\$72.06</td> </tr> <tr> <td>100+</td> <td>\$67.03</td> </tr> </tbody> </table> <p>PRECISION <b>SMA Male to SMA Female Miter Right Angle</b> VSWR 1.2:1 to 27 GHz</p> <p>Model No: <a href="#">PE91504</a></p>	PRICE		1-24	\$83.79	25-49	\$77.92	50-99	\$72.06	100+	\$67.03	 <table border="1"> <thead> <tr> <th colspan="2">PRICE</th> </tr> </thead> <tbody> <tr> <td>1-24</td> <td>\$62.54</td> </tr> <tr> <td>25-49</td> <td>\$59.41</td> </tr> <tr> <td>50-99</td> <td>\$56.29</td> </tr> <tr> <td>100+</td> <td>\$53.78</td> </tr> </tbody> </table> <p><b>SMA Male to SMA Female Bulkhead-Mounting Hole B02</b> VSWR 1.23:1 to 18 GHz</p> <p>Model No: <a href="#">PE9014</a></p>	PRICE		1-24	\$62.54	25-49	\$59.41	50-99	\$56.29	100+	\$53.78	 <table border="1"> <thead> <tr> <th colspan="2">PRICE</th> </tr> </thead> <tbody> <tr> <td>1-24</td> <td>\$55.77</td> </tr> <tr> <td>25-49</td> <td>\$52.98</td> </tr> <tr> <td>50-99</td> <td>\$50.19</td> </tr> <tr> <td>100+</td> <td>\$47.96</td> </tr> </tbody> </table> <p><b>SMA Male to SMA Female Bulkhead</b> VSWR 1.3:1 to 18 GHz</p> <p>Model No: <a href="#">PE9621</a></p>	PRICE		1-24	\$55.77	25-49	\$52.98	50-99	\$50.19	100+	\$47.96
	PRICE																																																						
1-24	\$84.04																																																						
25-49	\$79.84																																																						
50-99	\$75.64																																																						
100+	\$72.27																																																						
PRICE																																																							
1-24	\$76.80																																																						
25-49	\$72.96																																																						
50-99	\$69.12																																																						
100+	\$66.05																																																						
PRICE																																																							
1-24	\$83.79																																																						
25-49	\$77.92																																																						
50-99	\$72.06																																																						
100+	\$67.03																																																						
PRICE																																																							
1-24	\$62.54																																																						
25-49	\$59.41																																																						
50-99	\$56.29																																																						
100+	\$53.78																																																						
PRICE																																																							
1-24	\$55.77																																																						
25-49	\$52.98																																																						
50-99	\$50.19																																																						
100+	\$47.96																																																						
3	 <table border="1"> <thead> <tr> <th colspan="2">PRICE</th> </tr> </thead> <tbody> <tr> <td>1-24</td> <td>\$27.14</td> </tr> <tr> <td>25-49</td> <td>\$25.78</td> </tr> <tr> <td>50-99</td> <td>\$24.43</td> </tr> <tr> <td>100+</td> <td>\$23.34</td> </tr> </tbody> </table> <p><b>Push-On SMA Male to SMA Female Bulkhead</b> VSWR 1.23:1 to 18 GHz</p> <p>Model No: <a href="#">PE91321</a></p>	PRICE		1-24	\$27.14	25-49	\$25.78	50-99	\$24.43	100+	\$23.34	 <table border="1"> <thead> <tr> <th colspan="2">PRICE</th> </tr> </thead> <tbody> <tr> <td>1-24</td> <td>\$49.35</td> </tr> <tr> <td>25-49</td> <td>\$46.88</td> </tr> <tr> <td>50-99</td> <td>\$44.42</td> </tr> <tr> <td>100+</td> <td>\$42.44</td> </tr> </tbody> </table> <p><b>SMA Female to SMA Male Tee</b> Max. Freq. 6 GHz</p> <p>Model No: <a href="#">PE9182</a></p>	PRICE		1-24	\$49.35	25-49	\$46.88	50-99	\$44.42	100+	\$42.44	 <table border="1"> <thead> <tr> <th colspan="2">PRICE</th> </tr> </thead> <tbody> <tr> <td>1-24</td> <td>\$18.78</td> </tr> <tr> <td>25-49</td> <td>\$17.84</td> </tr> <tr> <td>50-99</td> <td>\$16.90</td> </tr> <tr> <td>100+</td> <td>\$16.15</td> </tr> </tbody> </table> <p><b>SMA Female to SMA Female</b> VSWR 1.25:1 to 18 GHz</p> <p>Model No: <a href="#">PE9070</a></p>	PRICE		1-24	\$18.78	25-49	\$17.84	50-99	\$16.90	100+	\$16.15	 <table border="1"> <thead> <tr> <th colspan="2">PRICE</th> </tr> </thead> <tbody> <tr> <td>1-24</td> <td>\$34.11</td> </tr> <tr> <td>25-49</td> <td>\$32.40</td> </tr> <tr> <td>50-99</td> <td>\$30.70</td> </tr> <tr> <td>100+</td> <td>\$29.33</td> </tr> </tbody> </table> <p><b>SMA Female to SMA Female</b> VSWR 1.23:1 to 18 GHz</p> <p>Model No: <a href="#">PE9380</a></p>	PRICE		1-24	\$34.11	25-49	\$32.40	50-99	\$30.70	100+	\$29.33	 <table border="1"> <thead> <tr> <th colspan="2">PRICE</th> </tr> </thead> <tbody> <tr> <td>1-24</td> <td>\$65.03</td> </tr> <tr> <td>25-49</td> <td>\$61.78</td> </tr> <tr> <td>50-99</td> <td>\$58.53</td> </tr> <tr> <td>100+</td> <td>\$55.93</td> </tr> </tbody> </table> <p>PRECISION <b>SMA Female to SMA Female</b> VSWR 1.2:1 to 27 GHz</p> <p>Model No: <a href="#">PE9507</a></p>	PRICE		1-24	\$65.03	25-49	\$61.78	50-99	\$58.53	100+	\$55.93
	PRICE																																																						
1-24	\$27.14																																																						
25-49	\$25.78																																																						
50-99	\$24.43																																																						
100+	\$23.34																																																						
PRICE																																																							
1-24	\$49.35																																																						
25-49	\$46.88																																																						
50-99	\$44.42																																																						
100+	\$42.44																																																						
PRICE																																																							
1-24	\$18.78																																																						
25-49	\$17.84																																																						
50-99	\$16.90																																																						
100+	\$16.15																																																						
PRICE																																																							
1-24	\$34.11																																																						
25-49	\$32.40																																																						
50-99	\$30.70																																																						
100+	\$29.33																																																						
PRICE																																																							
1-24	\$65.03																																																						
25-49	\$61.78																																																						
50-99	\$58.53																																																						
100+	\$55.93																																																						
4	 <table border="1"> <thead> <tr> <th colspan="2">PRICE</th> </tr> </thead> <tbody> <tr> <td>1-24</td> <td>\$45.52</td> </tr> <tr> <td>25-49</td> <td>\$43.24</td> </tr> <tr> <td>50-99</td> <td>\$40.97</td> </tr> <tr> <td>100+</td> <td>\$39.15</td> </tr> </tbody> </table> <p>PRECISION <b>SMA Female to SMA Female</b> VSWR 1.15:1 to 18 GHz</p> <p>Model No: <a href="#">PE9695</a></p>	PRICE		1-24	\$45.52	25-49	\$43.24	50-99	\$40.97	100+	\$39.15	 <table border="1"> <thead> <tr> <th colspan="2">PRICE</th> </tr> </thead> <tbody> <tr> <td>1-24</td> <td>\$60.16</td> </tr> <tr> <td>25-49</td> <td>\$57.15</td> </tr> <tr> <td>50-99</td> <td>\$54.14</td> </tr> <tr> <td>100+</td> <td>\$51.74</td> </tr> </tbody> </table> <p><b>SMA Female to SMA Female Right Angle</b></p> <p>Model No: <a href="#">PE9485</a></p>	PRICE		1-24	\$60.16	25-49	\$57.15	50-99	\$54.14	100+	\$51.74	 <table border="1"> <thead> <tr> <th colspan="2">PRICE</th> </tr> </thead> <tbody> <tr> <td>1-24</td> <td>\$67.74</td> </tr> <tr> <td>25-49</td> <td>\$64.35</td> </tr> <tr> <td>50-99</td> <td>\$60.97</td> </tr> <tr> <td>100+</td> <td>\$58.26</td> </tr> </tbody> </table> <p><b>SMA Female to SMA Female Tee</b> Max. Freq. 6 GHz</p> <p>Model No: <a href="#">PE9246</a></p>	PRICE		1-24	\$67.74	25-49	\$64.35	50-99	\$60.97	100+	\$58.26	 <table border="1"> <thead> <tr> <th colspan="2">PRICE</th> </tr> </thead> <tbody> <tr> <td>1-24</td> <td>\$20.11</td> </tr> <tr> <td>25-49</td> <td>\$19.10</td> </tr> <tr> <td>50-99</td> <td>\$18.10</td> </tr> <tr> <td>100+</td> <td>\$17.29</td> </tr> </tbody> </table> <p><b>SMA Female to SMA Female Bulkhead</b> VSWR 1.25:1 to 18 GHz</p> <p>Model No: <a href="#">PE91258</a></p>	PRICE		1-24	\$20.11	25-49	\$19.10	50-99	\$18.10	100+	\$17.29	 <table border="1"> <thead> <tr> <th colspan="2">PRICE</th> </tr> </thead> <tbody> <tr> <td>1-9</td> <td>\$113.12</td> </tr> <tr> <td>10-24</td> <td>\$107.46</td> </tr> <tr> <td>25-49</td> <td>\$101.81</td> </tr> <tr> <td>50+</td> <td>\$97.28</td> </tr> </tbody> </table> <p><b>SMA Female to SMA Female Bulkhead-Mounting Hole B02</b> VSWR 1.3:1 to 26.5 GHz</p> <p>Model No: <a href="#">PE9508</a></p>	PRICE		1-9	\$113.12	10-24	\$107.46	25-49	\$101.81	50+	\$97.28
	PRICE																																																						
1-24	\$45.52																																																						
25-49	\$43.24																																																						
50-99	\$40.97																																																						
100+	\$39.15																																																						
PRICE																																																							
1-24	\$60.16																																																						
25-49	\$57.15																																																						
50-99	\$54.14																																																						
100+	\$51.74																																																						
PRICE																																																							
1-24	\$67.74																																																						
25-49	\$64.35																																																						
50-99	\$60.97																																																						
100+	\$58.26																																																						
PRICE																																																							
1-24	\$20.11																																																						
25-49	\$19.10																																																						
50-99	\$18.10																																																						
100+	\$17.29																																																						
PRICE																																																							
1-9	\$113.12																																																						
10-24	\$107.46																																																						
25-49	\$101.81																																																						
50+	\$97.28																																																						
5	 <table border="1"> <thead> <tr> <th colspan="2">PRICE</th> </tr> </thead> <tbody> <tr> <td>1-24</td> <td>\$46.59</td> </tr> <tr> <td>25-49</td> <td>\$44.26</td> </tr> <tr> <td>50-99</td> <td>\$41.93</td> </tr> <tr> <td>100+</td> <td>\$40.07</td> </tr> </tbody> </table> <p>PRECISION <b>SMA Female to SMA Female Bulkhead-Mounting Hole B02</b> VSWR 1.15:1 to 18 GHz</p> <p>Model No: <a href="#">PE9620</a></p>	PRICE		1-24	\$46.59	25-49	\$44.26	50-99	\$41.93	100+	\$40.07	 <table border="1"> <thead> <tr> <th colspan="2">PRICE</th> </tr> </thead> <tbody> <tr> <td>1-9</td> <td>Call</td> </tr> <tr> <td>10-24</td> <td>Call</td> </tr> <tr> <td>25-49</td> <td>Call</td> </tr> <tr> <td>50+</td> <td>Call</td> </tr> </tbody> </table> <p>NEW <b>SMA Female to SMA Female Bulkhead</b> VSWR 1.35:1 to 18 GHz</p> <p>Model No: <a href="#">PE91393</a></p>	PRICE		1-9	Call	10-24	Call	25-49	Call	50+	Call	 <table border="1"> <thead> <tr> <th colspan="2">PRICE</th> </tr> </thead> <tbody> <tr> <td>1-24</td> <td>\$48.11</td> </tr> <tr> <td>25-49</td> <td>\$45.70</td> </tr> <tr> <td>50-99</td> <td>\$43.30</td> </tr> <tr> <td>100+</td> <td>\$41.37</td> </tr> </tbody> </table> <p><b>SMA Female to SMA Female Bulkhead</b> VSWR 1.4:1 to 18 GHz</p> <p>Model No: <a href="#">PE9184</a></p>	PRICE		1-24	\$48.11	25-49	\$45.70	50-99	\$43.30	100+	\$41.37	 <table border="1"> <thead> <tr> <th colspan="2">PRICE</th> </tr> </thead> <tbody> <tr> <td>1-24</td> <td>\$36.08</td> </tr> <tr> <td>25-49</td> <td>\$34.28</td> </tr> <tr> <td>50-99</td> <td>\$32.47</td> </tr> <tr> <td>100+</td> <td>\$31.03</td> </tr> </tbody> </table> <p><b>SMA Female to SMA Female Bulkhead</b> VSWR 1.25:1 to 12.4 GHz</p> <p>Model No: <a href="#">PE9067</a></p>	PRICE		1-24	\$36.08	25-49	\$34.28	50-99	\$32.47	100+	\$31.03	 <table border="1"> <thead> <tr> <th colspan="2">PRICE</th> </tr> </thead> <tbody> <tr> <td>1-24</td> <td>\$65.84</td> </tr> <tr> <td>25-49</td> <td>\$62.55</td> </tr> <tr> <td>50-99</td> <td>\$59.26</td> </tr> <tr> <td>100+</td> <td>\$56.62</td> </tr> </tbody> </table> <p><b>SMA Female to SMA Female 4 Hole Flange-Mounting Hole A01</b> VSWR 1.25:1 to 18 GHz</p> <p>Model No: <a href="#">PE9312</a></p>	PRICE		1-24	\$65.84	25-49	\$62.55	50-99	\$59.26	100+	\$56.62
	PRICE																																																						
1-24	\$46.59																																																						
25-49	\$44.26																																																						
50-99	\$41.93																																																						
100+	\$40.07																																																						
PRICE																																																							
1-9	Call																																																						
10-24	Call																																																						
25-49	Call																																																						
50+	Call																																																						
PRICE																																																							
1-24	\$48.11																																																						
25-49	\$45.70																																																						
50-99	\$43.30																																																						
100+	\$41.37																																																						
PRICE																																																							
1-24	\$36.08																																																						
25-49	\$34.28																																																						
50-99	\$32.47																																																						
100+	\$31.03																																																						
PRICE																																																							
1-24	\$65.84																																																						
25-49	\$62.55																																																						
50-99	\$59.26																																																						
100+	\$56.62																																																						
6	 <table border="1"> <thead> <tr> <th colspan="2">PRICE</th> </tr> </thead> <tbody> <tr> <td>1-24</td> <td>\$94.19</td> </tr> <tr> <td>25-49</td> <td>\$89.48</td> </tr> <tr> <td>50-99</td> <td>\$84.77</td> </tr> <tr> <td>100+</td> <td>\$81.00</td> </tr> </tbody> </table> <p><b>SMA Female to SMA Female 4 Hole Flange-Mounting Hole A01</b> VSWR 1.25:1 to 18 GHz</p> <p>Model No: <a href="#">PE9670</a></p>	PRICE		1-24	\$94.19	25-49	\$89.48	50-99	\$84.77	100+	\$81.00	 <table border="1"> <thead> <tr> <th colspan="2">PRICE</th> </tr> </thead> <tbody> <tr> <td>1-24</td> <td>\$24.21</td> </tr> <tr> <td>25-49</td> <td>\$23.00</td> </tr> <tr> <td>50-99</td> <td>\$21.79</td> </tr> <tr> <td>100+</td> <td>\$20.82</td> </tr> </tbody> </table> <p><b>SMA Female to SMA Female Bulkhead</b> VSWR 1.23:1 to 18 GHz</p> <p>Model No: <a href="#">PE9184NH</a></p>	PRICE		1-24	\$24.21	25-49	\$23.00	50-99	\$21.79	100+	\$20.82	 <table border="1"> <thead> <tr> <th colspan="2">PRICE</th> </tr> </thead> <tbody> <tr> <td>1-24</td> <td>\$21.04</td> </tr> <tr> <td>25-49</td> <td>\$19.99</td> </tr> <tr> <td>50-99</td> <td>\$18.94</td> </tr> <tr> <td>100+</td> <td>\$18.09</td> </tr> </tbody> </table> <p><b>SMA Female to SMA Female 2 Hole Flange</b> VSWR 1.25:1 to 18 GHz</p> <p>Model No: <a href="#">PE91290</a></p>	PRICE		1-24	\$21.04	25-49	\$19.99	50-99	\$18.94	100+	\$18.09	<p><b>Reverse Polarity SMA In-Series</b></p> 																					
	PRICE																																																						
1-24	\$94.19																																																						
25-49	\$89.48																																																						
50-99	\$84.77																																																						
100+	\$81.00																																																						
PRICE																																																							
1-24	\$24.21																																																						
25-49	\$23.00																																																						
50-99	\$21.79																																																						
100+	\$20.82																																																						
PRICE																																																							
1-24	\$21.04																																																						
25-49	\$19.99																																																						
50-99	\$18.94																																																						
100+	\$18.09																																																						
7	 <table border="1"> <thead> <tr> <th colspan="2">PRICE</th> </tr> </thead> <tbody> <tr> <td>1-24</td> <td>\$68.10</td> </tr> <tr> <td>25-49</td> <td>\$64.70</td> </tr> <tr> <td>50-99</td> <td>\$61.29</td> </tr> <tr> <td>100+</td> <td>\$58.57</td> </tr> </tbody> </table> <p><b>QD SMA Male to Rev. Pol. SMA Female</b> VSWR 1.25:1 to 18 GHz</p> <p>Model No: <a href="#">PE91265</a></p>	PRICE		1-24	\$68.10	25-49	\$64.70	50-99	\$61.29	100+	\$58.57	 <table border="1"> <thead> <tr> <th colspan="2">PRICE</th> </tr> </thead> <tbody> <tr> <td>1-24</td> <td>\$42.26</td> </tr> <tr> <td>25-49</td> <td>\$40.15</td> </tr> <tr> <td>50-99</td> <td>\$38.03</td> </tr> <tr> <td>100+</td> <td>\$36.34</td> </tr> </tbody> </table> <p><b>SMA Male to Rev. Pol. SMA Female</b> VSWR 1.25:1 to 18 GHz</p> <p>Model No: <a href="#">PE9534</a></p>	PRICE		1-24	\$42.26	25-49	\$40.15	50-99	\$38.03	100+	\$36.34	 <table border="1"> <thead> <tr> <th colspan="2">PRICE</th> </tr> </thead> <tbody> <tr> <td>1-24</td> <td>\$46.67</td> </tr> <tr> <td>25-49</td> <td>\$44.34</td> </tr> <tr> <td>50-99</td> <td>\$42.00</td> </tr> <tr> <td>100+</td> <td>\$40.14</td> </tr> </tbody> </table> <p><b>SMA Male to Rev. Pol. SMA Female Right Angle</b> VSWR 1.23:1 to 12.4 GHz</p> <p>Model No: <a href="#">PE91264</a></p>	PRICE		1-24	\$46.67	25-49	\$44.34	50-99	\$42.00	100+	\$40.14	 <table border="1"> <thead> <tr> <th colspan="2">PRICE</th> </tr> </thead> <tbody> <tr> <td>1-24</td> <td>\$23.46</td> </tr> <tr> <td>25-49</td> <td>\$22.29</td> </tr> <tr> <td>50-99</td> <td>\$21.11</td> </tr> <tr> <td>100+</td> <td>\$20.18</td> </tr> </tbody> </table> <p><b>SMA Female to Rev. Pol. SMA Male</b> VSWR 1.25:1 to 18 GHz</p> <p>Model No: <a href="#">PE9533</a></p>	PRICE		1-24	\$23.46	25-49	\$22.29	50-99	\$21.11	100+	\$20.18	 <table border="1"> <thead> <tr> <th colspan="2">PRICE</th> </tr> </thead> <tbody> <tr> <td>1-24</td> <td>\$37.54</td> </tr> <tr> <td>25-49</td> <td>\$35.66</td> </tr> <tr> <td>50-99</td> <td>\$33.79</td> </tr> <tr> <td>100+</td> <td>\$32.28</td> </tr> </tbody> </table> <p><b>SMA Female to Rev. Pol. SMA Female</b> VSWR 1.2:1 to 18 GHz</p> <p>Model No: <a href="#">PE91260</a></p>	PRICE		1-24	\$37.54	25-49	\$35.66	50-99	\$33.79	100+	\$32.28
	PRICE																																																						
1-24	\$68.10																																																						
25-49	\$64.70																																																						
50-99	\$61.29																																																						
100+	\$58.57																																																						
PRICE																																																							
1-24	\$42.26																																																						
25-49	\$40.15																																																						
50-99	\$38.03																																																						
100+	\$36.34																																																						
PRICE																																																							
1-24	\$46.67																																																						
25-49	\$44.34																																																						
50-99	\$42.00																																																						
100+	\$40.14																																																						
PRICE																																																							
1-24	\$23.46																																																						
25-49	\$22.29																																																						
50-99	\$21.11																																																						
100+	\$20.18																																																						
PRICE																																																							
1-24	\$37.54																																																						
25-49	\$35.66																																																						
50-99	\$33.79																																																						
100+	\$32.28																																																						

# ADAPTERS

See Adapter Locator on Pages 8-13

See Page 369 for Mounting Holes

	A	B	C	D	E																																													
1	 <table border="1"> <thead> <tr><th>PRICE</th></tr> </thead> <tbody> <tr><td>1-24</td><td>\$113.55</td></tr> <tr><td>25-49</td><td>\$107.87</td></tr> <tr><td>50-99</td><td>\$102.20</td></tr> <tr><td>100+</td><td>\$97.65</td></tr> </tbody> </table> <p>QD Rev. Pol. SMA Male to SMA Male VSWR 1.25:1 to 18 GHz Model No: <a href="#">PE91266</a></p>	PRICE	1-24	\$113.55	25-49	\$107.87	50-99	\$102.20	100+	\$97.65	 <table border="1"> <thead> <tr><th>PRICE</th></tr> </thead> <tbody> <tr><td>1-24</td><td>\$68.10</td></tr> <tr><td>25-49</td><td>\$64.70</td></tr> <tr><td>50-99</td><td>\$61.29</td></tr> <tr><td>100+</td><td>\$58.57</td></tr> </tbody> </table> <p>QD Rev. Pol. SMA Male to SMA Female VSWR 1.25:1 to 18 GHz Model No: <a href="#">PE91267</a></p>	PRICE	1-24	\$68.10	25-49	\$64.70	50-99	\$61.29	100+	\$58.57	 <table border="1"> <thead> <tr><th>PRICE</th></tr> </thead> <tbody> <tr><td>1-24</td><td>\$38.24</td></tr> <tr><td>25-49</td><td>\$36.33</td></tr> <tr><td>50-99</td><td>\$34.42</td></tr> <tr><td>100+</td><td>\$32.89</td></tr> </tbody> </table> <p>Rev. Pol. SMA Male to SMA Female Right Angle VSWR 1.23:1 to 12.4 GHz Model No: <a href="#">PE91263</a></p>	PRICE	1-24	\$38.24	25-49	\$36.33	50-99	\$34.42	100+	\$32.89	 <table border="1"> <thead> <tr><th>PRICE</th></tr> </thead> <tbody> <tr><td>1-24</td><td>\$45.39</td></tr> <tr><td>25-49</td><td>\$43.12</td></tr> <tr><td>50-99</td><td>\$40.85</td></tr> <tr><td>100+</td><td>\$39.04</td></tr> </tbody> </table> <p>Rev. Pol. SMA Male to Rev. Pol. SMA Male VSWR 1.2:1 to 18 GHz Model No: <a href="#">PE91261</a></p>	PRICE	1-24	\$45.39	25-49	\$43.12	50-99	\$40.85	100+	\$39.04	 <table border="1"> <thead> <tr><th>PRICE</th></tr> </thead> <tbody> <tr><td>1-24</td><td>\$55.97</td></tr> <tr><td>25-49</td><td>\$53.17</td></tr> <tr><td>50-99</td><td>\$50.37</td></tr> <tr><td>100+</td><td>\$48.13</td></tr> </tbody> </table> <p>Rev. Pol. SMA Male to Rev. Pol. SMA Male VSWR 1.35:1 to 6 GHz Model No: <a href="#">PE91330</a></p>	PRICE	1-24	\$55.97	25-49	\$53.17	50-99	\$50.37	100+	\$48.13
	PRICE																																																	
1-24	\$113.55																																																	
25-49	\$107.87																																																	
50-99	\$102.20																																																	
100+	\$97.65																																																	
PRICE																																																		
1-24	\$68.10																																																	
25-49	\$64.70																																																	
50-99	\$61.29																																																	
100+	\$58.57																																																	
PRICE																																																		
1-24	\$38.24																																																	
25-49	\$36.33																																																	
50-99	\$34.42																																																	
100+	\$32.89																																																	
PRICE																																																		
1-24	\$45.39																																																	
25-49	\$43.12																																																	
50-99	\$40.85																																																	
100+	\$39.04																																																	
PRICE																																																		
1-24	\$55.97																																																	
25-49	\$53.17																																																	
50-99	\$50.37																																																	
100+	\$48.13																																																	
2	 <table border="1"> <thead> <tr><th>PRICE</th></tr> </thead> <tbody> <tr><td>1-24</td><td>\$68.10</td></tr> <tr><td>25-49</td><td>\$64.70</td></tr> <tr><td>50-99</td><td>\$61.29</td></tr> <tr><td>100+</td><td>\$58.57</td></tr> </tbody> </table> <p>QD Rev. Pol. SMA Male to Rev. Pol. SMA Female VSWR 1.25:1 to 18 GHz Model No: <a href="#">PE91268</a></p>	PRICE	1-24	\$68.10	25-49	\$64.70	50-99	\$61.29	100+	\$58.57	 <table border="1"> <thead> <tr><th>PRICE</th></tr> </thead> <tbody> <tr><td>1-24</td><td>\$55.85</td></tr> <tr><td>25-49</td><td>\$53.06</td></tr> <tr><td>50-99</td><td>\$50.27</td></tr> <tr><td>100+</td><td>\$48.03</td></tr> </tbody> </table> <p>Rev. Pol. SMA Male to Rev. Pol. SMA Female VSWR 1.35:1 to 6 GHz Model No: <a href="#">PE91331</a></p>	PRICE	1-24	\$55.85	25-49	\$53.06	50-99	\$50.27	100+	\$48.03	 <table border="1"> <thead> <tr><th>PRICE</th></tr> </thead> <tbody> <tr><td>1-24</td><td>\$37.54</td></tr> <tr><td>25-49</td><td>\$35.66</td></tr> <tr><td>50-99</td><td>\$33.79</td></tr> <tr><td>100+</td><td>\$32.28</td></tr> </tbody> </table> <p>Rev. Pol. SMA Male to Rev. Pol. SMA Female Right Angle VSWR 1.25:1 to 6 GHz Model No: <a href="#">PE9594</a></p>	PRICE	1-24	\$37.54	25-49	\$35.66	50-99	\$33.79	100+	\$32.28	 <table border="1"> <thead> <tr><th>PRICE</th></tr> </thead> <tbody> <tr><td>1-24</td><td>\$45.39</td></tr> <tr><td>25-49</td><td>\$43.12</td></tr> <tr><td>50-99</td><td>\$40.85</td></tr> <tr><td>100+</td><td>\$39.04</td></tr> </tbody> </table> <p>Rev. Pol. SMA Female to Rev. Pol. SMA Female VSWR 1.2:1 to 18 GHz Model No: <a href="#">PE91262</a></p>	PRICE	1-24	\$45.39	25-49	\$43.12	50-99	\$40.85	100+	\$39.04	 <table border="1"> <thead> <tr><th>PRICE</th></tr> </thead> <tbody> <tr><td>1-24</td><td>\$36.83</td></tr> <tr><td>25-49</td><td>\$34.99</td></tr> <tr><td>50-99</td><td>\$33.15</td></tr> <tr><td>100+</td><td>\$31.67</td></tr> </tbody> </table> <p>Rev. Pol. SMA Female to Rev. Pol. SMA Female VSWR 1.35:1 to 6 GHz Model No: <a href="#">PE91334</a></p>	PRICE	1-24	\$36.83	25-49	\$34.99	50-99	\$33.15	100+	\$31.67
	PRICE																																																	
1-24	\$68.10																																																	
25-49	\$64.70																																																	
50-99	\$61.29																																																	
100+	\$58.57																																																	
PRICE																																																		
1-24	\$55.85																																																	
25-49	\$53.06																																																	
50-99	\$50.27																																																	
100+	\$48.03																																																	
PRICE																																																		
1-24	\$37.54																																																	
25-49	\$35.66																																																	
50-99	\$33.79																																																	
100+	\$32.28																																																	
PRICE																																																		
1-24	\$45.39																																																	
25-49	\$43.12																																																	
50-99	\$40.85																																																	
100+	\$39.04																																																	
PRICE																																																		
1-24	\$36.83																																																	
25-49	\$34.99																																																	
50-99	\$33.15																																																	
100+	\$31.67																																																	
3	 <table border="1"> <thead> <tr><th>PRICE</th></tr> </thead> <tbody> <tr><td>1-24</td><td>\$53.06</td></tr> <tr><td>25-49</td><td>\$50.41</td></tr> <tr><td>50-99</td><td>\$47.75</td></tr> <tr><td>100+</td><td>\$45.63</td></tr> </tbody> </table> <p>Rev. Pol. SMA Female to Rev. Pol. SMA Female Bulkhead-Mounting Hole B02 VSWR 1.25:1 to 18 GHz Model No: <a href="#">PE9593</a></p>	PRICE	1-24	\$53.06	25-49	\$50.41	50-99	\$47.75	100+	\$45.63	 <table border="1"> <thead> <tr><th>PRICE</th></tr> </thead> <tbody> <tr><td>1-24</td><td>\$46.74</td></tr> <tr><td>25-49</td><td>\$44.40</td></tr> <tr><td>50-99</td><td>\$42.07</td></tr> <tr><td>100+</td><td>\$40.20</td></tr> </tbody> </table> <p>Rev. Pol. SMA Female to Rev. Pol. SMA Female 2 Hole Flange VSWR 1.2:1 to 18 GHz Model No: <a href="#">PE91270</a></p>	PRICE	1-24	\$46.74	25-49	\$44.40	50-99	\$42.07	100+	\$40.20	 <table border="1"> <thead> <tr><th>PRICE</th></tr> </thead> <tbody> <tr><td>1-24</td><td>\$48.28</td></tr> <tr><td>25-49</td><td>\$45.87</td></tr> <tr><td>50-99</td><td>\$43.45</td></tr> <tr><td>100+</td><td>\$41.52</td></tr> </tbody> </table> <p>Rev. Pol. SMA Female to Rev. Pol. SMA Female 4 Hole Flange VSWR 1.2:1 to 18 GHz Model No: <a href="#">PE91269</a></p>	PRICE	1-24	\$48.28	25-49	\$45.87	50-99	\$43.45	100+	\$41.52	<p><b>Reverse Thread SMA In-Series</b></p> 																			
	PRICE																																																	
1-24	\$53.06																																																	
25-49	\$50.41																																																	
50-99	\$47.75																																																	
100+	\$45.63																																																	
PRICE																																																		
1-24	\$46.74																																																	
25-49	\$44.40																																																	
50-99	\$42.07																																																	
100+	\$40.20																																																	
PRICE																																																		
1-24	\$48.28																																																	
25-49	\$45.87																																																	
50-99	\$43.45																																																	
100+	\$41.52																																																	
4	 <table border="1"> <thead> <tr><th>PRICE</th></tr> </thead> <tbody> <tr><td>1-24</td><td>\$61.36</td></tr> <tr><td>25-49</td><td>\$58.29</td></tr> <tr><td>50-99</td><td>\$55.22</td></tr> <tr><td>100+</td><td>\$52.77</td></tr> </tbody> </table> <p>SMA Female to Reverse Thread SMA Male Model No: <a href="#">PE9683</a></p>	PRICE	1-24	\$61.36	25-49	\$58.29	50-99	\$55.22	100+	\$52.77	<p><b>SMA Between Series</b></p> 		 <table border="1"> <thead> <tr><th>PRICE</th></tr> </thead> <tbody> <tr><td>1-24</td><td>\$117.37</td></tr> <tr><td>25-49</td><td>\$111.50</td></tr> <tr><td>50-99</td><td>\$105.63</td></tr> <tr><td>100+</td><td>\$100.94</td></tr> </tbody> </table> <p>SMA Male to 1.0/2.3 Plug Model No: <a href="#">PE9692</a></p>	PRICE	1-24	\$117.37	25-49	\$111.50	50-99	\$105.63	100+	\$100.94	 <table border="1"> <thead> <tr><th>PRICE</th></tr> </thead> <tbody> <tr><td>1-24</td><td>\$96.12</td></tr> <tr><td>25-49</td><td>\$91.31</td></tr> <tr><td>50-99</td><td>\$86.51</td></tr> <tr><td>100+</td><td>\$82.66</td></tr> </tbody> </table> <p>SMA Male to 1.0/2.3 Jack Model No: <a href="#">PE9690</a></p>	PRICE	1-24	\$96.12	25-49	\$91.31	50-99	\$86.51	100+	\$82.66																		
	PRICE																																																	
1-24	\$61.36																																																	
25-49	\$58.29																																																	
50-99	\$55.22																																																	
100+	\$52.77																																																	
PRICE																																																		
1-24	\$117.37																																																	
25-49	\$111.50																																																	
50-99	\$105.63																																																	
100+	\$100.94																																																	
PRICE																																																		
1-24	\$96.12																																																	
25-49	\$91.31																																																	
50-99	\$86.51																																																	
100+	\$82.66																																																	
5	 <table border="1"> <thead> <tr><th>PRICE</th></tr> </thead> <tbody> <tr><td>1-9</td><td>\$222.33</td></tr> <tr><td>10-24</td><td>\$211.21</td></tr> <tr><td>25-49</td><td>\$200.10</td></tr> <tr><td>50+</td><td>\$191.20</td></tr> </tbody> </table> <p>SMA Male to 1.85mm Female VSWR 1.3:1 to 18 GHz Model No: <a href="#">PE9728</a></p>	PRICE	1-9	\$222.33	10-24	\$211.21	25-49	\$200.10	50+	\$191.20	 <table border="1"> <thead> <tr><th>PRICE</th></tr> </thead> <tbody> <tr><td>1-9</td><td>\$208.85</td></tr> <tr><td>10-24</td><td>\$198.41</td></tr> <tr><td>25-49</td><td>\$187.97</td></tr> <tr><td>50+</td><td>\$179.61</td></tr> </tbody> </table> <p>PRECISION SMA Male to 2.4mm Male VSWR 1.2:1 to 26.5 GHz Model No: <a href="#">PE9653</a></p>	PRICE	1-9	\$208.85	10-24	\$198.41	25-49	\$187.97	50+	\$179.61	 <table border="1"> <thead> <tr><th>PRICE</th></tr> </thead> <tbody> <tr><td>1-9</td><td>\$229.87</td></tr> <tr><td>10-24</td><td>\$218.38</td></tr> <tr><td>25-49</td><td>\$206.88</td></tr> <tr><td>50+</td><td>\$197.69</td></tr> </tbody> </table> <p>PRECISION SMA Male to 2.4mm Female VSWR 1.2:1 to 26.5 GHz Model No: <a href="#">PE9654</a></p>	PRICE	1-9	\$229.87	10-24	\$218.38	25-49	\$206.88	50+	\$197.69	 <table border="1"> <thead> <tr><th>PRICE</th></tr> </thead> <tbody> <tr><td>1-9</td><td>\$215.22</td></tr> <tr><td>10-24</td><td>\$204.46</td></tr> <tr><td>25-49</td><td>\$193.70</td></tr> <tr><td>50+</td><td>\$185.09</td></tr> </tbody> </table> <p>PRECISION SMA Male to 2.92mm Male VSWR 1.2:1 to 26.5 GHz Model No: <a href="#">PE91010</a></p>	PRICE	1-9	\$215.22	10-24	\$204.46	25-49	\$193.70	50+	\$185.09	 <table border="1"> <thead> <tr><th>PRICE</th></tr> </thead> <tbody> <tr><td>1-9</td><td>\$211.08</td></tr> <tr><td>10-24</td><td>\$200.53</td></tr> <tr><td>25-49</td><td>\$189.97</td></tr> <tr><td>50+</td><td>\$181.53</td></tr> </tbody> </table> <p>PRECISION SMA Male to 2.92mm Female VSWR 1.2:1 to 26.5 GHz Model No: <a href="#">PE91008</a></p>	PRICE	1-9	\$211.08	10-24	\$200.53	25-49	\$189.97	50+	\$181.53
	PRICE																																																	
1-9	\$222.33																																																	
10-24	\$211.21																																																	
25-49	\$200.10																																																	
50+	\$191.20																																																	
PRICE																																																		
1-9	\$208.85																																																	
10-24	\$198.41																																																	
25-49	\$187.97																																																	
50+	\$179.61																																																	
PRICE																																																		
1-9	\$229.87																																																	
10-24	\$218.38																																																	
25-49	\$206.88																																																	
50+	\$197.69																																																	
PRICE																																																		
1-9	\$215.22																																																	
10-24	\$204.46																																																	
25-49	\$193.70																																																	
50+	\$185.09																																																	
PRICE																																																		
1-9	\$211.08																																																	
10-24	\$200.53																																																	
25-49	\$189.97																																																	
50+	\$181.53																																																	
6	 <table border="1"> <thead> <tr><th>PRICE</th></tr> </thead> <tbody> <tr><td>1-9</td><td>\$212.43</td></tr> <tr><td>10-24</td><td>\$201.81</td></tr> <tr><td>25-49</td><td>\$191.19</td></tr> <tr><td>50+</td><td>\$182.69</td></tr> </tbody> </table> <p>SMA Male to 3.5mm Male VSWR 1.25:1 to 18 GHz Model No: <a href="#">PE9722</a></p>	PRICE	1-9	\$212.43	10-24	\$201.81	25-49	\$191.19	50+	\$182.69	 <table border="1"> <thead> <tr><th>PRICE</th></tr> </thead> <tbody> <tr><td>1-4</td><td>\$526.44</td></tr> <tr><td>5-9</td><td>\$500.12</td></tr> <tr><td>10-24</td><td>\$473.80</td></tr> <tr><td>25+</td><td>\$452.74</td></tr> </tbody> </table> <p>PRECISION SMA Male to 7mm Sexless VSWR 1.15:1 to 18 GHz Model No: <a href="#">PE9215</a></p>	PRICE	1-4	\$526.44	5-9	\$500.12	10-24	\$473.80	25+	\$452.74	 <table border="1"> <thead> <tr><th>PRICE</th></tr> </thead> <tbody> <tr><td>1-9</td><td>\$119.52</td></tr> <tr><td>10-24</td><td>\$113.54</td></tr> <tr><td>25-49</td><td>\$107.57</td></tr> <tr><td>50+</td><td>\$102.79</td></tr> </tbody> </table> <p>Low PIM SMA Male to 7/16 DIN Male VSWR 1.09:1 to 7.5 GHz Model No: <a href="#">PE91043</a></p>	PRICE	1-9	\$119.52	10-24	\$113.54	25-49	\$107.57	50+	\$102.79	 <table border="1"> <thead> <tr><th>PRICE</th></tr> </thead> <tbody> <tr><td>1-9</td><td>\$107.89</td></tr> <tr><td>10-24</td><td>\$102.50</td></tr> <tr><td>25-49</td><td>\$97.10</td></tr> <tr><td>50+</td><td>\$92.79</td></tr> </tbody> </table> <p>Low PIM SMA Male to 7/16 DIN Female Max. Freq. 8 GHz Model No: <a href="#">PE91041</a></p>	PRICE	1-9	\$107.89	10-24	\$102.50	25-49	\$97.10	50+	\$92.79	 <table border="1"> <thead> <tr><th>PRICE</th></tr> </thead> <tbody> <tr><td>1-9</td><td>\$170.61</td></tr> <tr><td>10-24</td><td>\$162.08</td></tr> <tr><td>25-49</td><td>\$153.55</td></tr> <tr><td>50+</td><td>\$146.72</td></tr> </tbody> </table> <p>SMA Male to 7/16 DIN Female Model No: <a href="#">PE9411</a></p>	PRICE	1-9	\$170.61	10-24	\$162.08	25-49	\$153.55	50+	\$146.72
	PRICE																																																	
1-9	\$212.43																																																	
10-24	\$201.81																																																	
25-49	\$191.19																																																	
50+	\$182.69																																																	
PRICE																																																		
1-4	\$526.44																																																	
5-9	\$500.12																																																	
10-24	\$473.80																																																	
25+	\$452.74																																																	
PRICE																																																		
1-9	\$119.52																																																	
10-24	\$113.54																																																	
25-49	\$107.57																																																	
50+	\$102.79																																																	
PRICE																																																		
1-9	\$107.89																																																	
10-24	\$102.50																																																	
25-49	\$97.10																																																	
50+	\$92.79																																																	
PRICE																																																		
1-9	\$170.61																																																	
10-24	\$162.08																																																	
25-49	\$153.55																																																	
50+	\$146.72																																																	
7	 <table border="1"> <thead> <tr><th>PRICE</th></tr> </thead> <tbody> <tr><td>1-24</td><td>\$44.11</td></tr> <tr><td>25-49</td><td>\$41.90</td></tr> <tr><td>50-99</td><td>\$39.70</td></tr> <tr><td>100+</td><td>\$37.93</td></tr> </tbody> </table> <p>SMA Male to BNC Male Max. Freq. 4 GHz Model No: <a href="#">PE9072</a></p>	PRICE	1-24	\$44.11	25-49	\$41.90	50-99	\$39.70	100+	\$37.93	 <table border="1"> <thead> <tr><th>PRICE</th></tr> </thead> <tbody> <tr><td>1-24</td><td>\$113.61</td></tr> <tr><td>25-49</td><td>\$107.93</td></tr> <tr><td>50-99</td><td>\$102.25</td></tr> <tr><td>100+</td><td>\$97.70</td></tr> </tbody> </table> <p>SMA Male to BNC Male VSWR 1.25:1 to 8 GHz Model No: <a href="#">PE9493</a></p>	PRICE	1-24	\$113.61	25-49	\$107.93	50-99	\$102.25	100+	\$97.70	 <table border="1"> <thead> <tr><th>PRICE</th></tr> </thead> <tbody> <tr><td>1-24</td><td>\$27.87</td></tr> <tr><td>25-49</td><td>\$26.48</td></tr> <tr><td>50-99</td><td>\$25.08</td></tr> <tr><td>100+</td><td>\$23.97</td></tr> </tbody> </table> <p>SMA Male to BNC Female VSWR 1.3:1 to 4 GHz Model No: <a href="#">PE9074</a></p>	PRICE	1-24	\$27.87	25-49	\$26.48	50-99	\$25.08	100+	\$23.97	 <table border="1"> <thead> <tr><th>PRICE</th></tr> </thead> <tbody> <tr><td>1-9</td><td>\$148.74</td></tr> <tr><td>10-24</td><td>\$141.30</td></tr> <tr><td>25-49</td><td>\$133.87</td></tr> <tr><td>50+</td><td>\$127.92</td></tr> </tbody> </table> <p>SMA Male to BNC Female VSWR 1.25:1 to 8 GHz Model No: <a href="#">PE9495</a></p>	PRICE	1-9	\$148.74	10-24	\$141.30	25-49	\$133.87	50+	\$127.92	 <table border="1"> <thead> <tr><th>PRICE</th></tr> </thead> <tbody> <tr><td>1-24</td><td>\$35.98</td></tr> <tr><td>25-49</td><td>\$34.18</td></tr> <tr><td>50-99</td><td>\$32.38</td></tr> <tr><td>100+</td><td>\$30.94</td></tr> </tbody> </table> <p>SMA Male to 75 Ohm F Female Max. Freq. 2 GHz Model No: <a href="#">PE91003</a></p>	PRICE	1-24	\$35.98	25-49	\$34.18	50-99	\$32.38	100+	\$30.94
	PRICE																																																	
1-24	\$44.11																																																	
25-49	\$41.90																																																	
50-99	\$39.70																																																	
100+	\$37.93																																																	
PRICE																																																		
1-24	\$113.61																																																	
25-49	\$107.93																																																	
50-99	\$102.25																																																	
100+	\$97.70																																																	
PRICE																																																		
1-24	\$27.87																																																	
25-49	\$26.48																																																	
50-99	\$25.08																																																	
100+	\$23.97																																																	
PRICE																																																		
1-9	\$148.74																																																	
10-24	\$141.30																																																	
25-49	\$133.87																																																	
50+	\$127.92																																																	
PRICE																																																		
1-24	\$35.98																																																	
25-49	\$34.18																																																	
50-99	\$32.38																																																	
100+	\$30.94																																																	



Technical Support  
+1 (949) 261-1920



Same-Day Shipping,  
Even Custom Cable Assemblies

# ADAPTERS

See Adapter Locator on Pages 8-13

See Page 369 for Mounting Holes

	A	B	C	D	E																																																		
1	 <table border="1"> <thead> <tr><th colspan="2">PRICE</th></tr> </thead> <tbody> <tr><td>1-24</td><td>\$23.07</td></tr> <tr><td>25-49</td><td>\$21.92</td></tr> <tr><td>50-99</td><td>\$20.76</td></tr> <tr><td>100+</td><td>\$19.84</td></tr> </tbody> </table> <p><b>SMA Male to FME Jack</b></p> <p>Model No: <a href="#">PE9707</a></p>	PRICE		1-24	\$23.07	25-49	\$21.92	50-99	\$20.76	100+	\$19.84	 <table border="1"> <thead> <tr><th colspan="2">PRICE</th></tr> </thead> <tbody> <tr><td>1-9</td><td>\$244.12</td></tr> <tr><td>10-24</td><td>\$231.91</td></tr> <tr><td>25-49</td><td>\$219.71</td></tr> <tr><td>50+</td><td>\$209.94</td></tr> </tbody> </table> <p><b>SMA Male to GR874 Sexless</b></p> <p>Model No: <a href="#">PE9259</a></p>	PRICE		1-9	\$244.12	10-24	\$231.91	25-49	\$219.71	50+	\$209.94	 <table border="1"> <thead> <tr><th colspan="2">PRICE</th></tr> </thead> <tbody> <tr><td>1-24</td><td>\$92.46</td></tr> <tr><td>25-49</td><td>\$87.84</td></tr> <tr><td>50-99</td><td>\$83.21</td></tr> <tr><td>NEW 100+</td><td>\$79.52</td></tr> </tbody> </table> <p><b>SMA Male to HN Male</b> VSWR 1.4:1 to 4 GHz</p> <p>Model No: <a href="#">PE91448</a></p>	PRICE		1-24	\$92.46	25-49	\$87.84	50-99	\$83.21	NEW 100+	\$79.52	 <table border="1"> <thead> <tr><th colspan="2">PRICE</th></tr> </thead> <tbody> <tr><td>1-9</td><td>\$138.57</td></tr> <tr><td>10-24</td><td>\$131.64</td></tr> <tr><td>25-49</td><td>\$124.71</td></tr> <tr><td>50+</td><td>\$119.17</td></tr> </tbody> </table> <p><b>SMA Male to HN Female</b></p> <p>Model No: <a href="#">PE9256</a></p>	PRICE		1-9	\$138.57	10-24	\$131.64	25-49	\$124.71	50+	\$119.17	 <table border="1"> <thead> <tr><th colspan="2">PRICE</th></tr> </thead> <tbody> <tr><td>1-24</td><td>\$113.69</td></tr> <tr><td>25-49</td><td>\$108.01</td></tr> <tr><td>50-99</td><td>\$102.32</td></tr> <tr><td>100+</td><td>\$97.77</td></tr> </tbody> </table> <p><b>SMA Male to MCX Plug</b></p> <p>Model No: <a href="#">PE9473</a></p>	PRICE		1-24	\$113.69	25-49	\$108.01	50-99	\$102.32	100+	\$97.77
	PRICE																																																						
1-24	\$23.07																																																						
25-49	\$21.92																																																						
50-99	\$20.76																																																						
100+	\$19.84																																																						
PRICE																																																							
1-9	\$244.12																																																						
10-24	\$231.91																																																						
25-49	\$219.71																																																						
50+	\$209.94																																																						
PRICE																																																							
1-24	\$92.46																																																						
25-49	\$87.84																																																						
50-99	\$83.21																																																						
NEW 100+	\$79.52																																																						
PRICE																																																							
1-9	\$138.57																																																						
10-24	\$131.64																																																						
25-49	\$124.71																																																						
50+	\$119.17																																																						
PRICE																																																							
1-24	\$113.69																																																						
25-49	\$108.01																																																						
50-99	\$102.32																																																						
100+	\$97.77																																																						
2	 <table border="1"> <thead> <tr><th colspan="2">PRICE</th></tr> </thead> <tbody> <tr><td>1-24</td><td>\$104.58</td></tr> <tr><td>25-49</td><td>\$99.35</td></tr> <tr><td>50-99</td><td>\$94.12</td></tr> <tr><td>100+</td><td>\$89.94</td></tr> </tbody> </table> <p><b>SMA Male to MCX Jack</b></p> <p>Model No: <a href="#">PE9472</a></p>	PRICE		1-24	\$104.58	25-49	\$99.35	50-99	\$94.12	100+	\$89.94	 <table border="1"> <thead> <tr><th colspan="2">PRICE</th></tr> </thead> <tbody> <tr><td>1-24</td><td>\$89.02</td></tr> <tr><td>25-49</td><td>\$84.57</td></tr> <tr><td>50-99</td><td>\$80.12</td></tr> <tr><td>100+</td><td>\$76.56</td></tr> </tbody> </table> <p><b>SMA Male to Full Detent Mini SMP Male</b> VSWR 1.2:1 to 18 GHz</p> <p>Model No: <a href="#">PE91302</a></p>	PRICE		1-24	\$89.02	25-49	\$84.57	50-99	\$80.12	100+	\$76.56	 <table border="1"> <thead> <tr><th colspan="2">PRICE</th></tr> </thead> <tbody> <tr><td>1-24</td><td>\$100.77</td></tr> <tr><td>25-49</td><td>\$95.73</td></tr> <tr><td>50-99</td><td>\$90.69</td></tr> <tr><td>100+</td><td>\$86.66</td></tr> </tbody> </table> <p><b>SMA Male to Smooth Bore Mini SMP Male</b> VSWR 1.2:1 to 18 GHz</p> <p>Model No: <a href="#">PE91303</a></p>	PRICE		1-24	\$100.77	25-49	\$95.73	50-99	\$90.69	100+	\$86.66	 <table border="1"> <thead> <tr><th colspan="2">PRICE</th></tr> </thead> <tbody> <tr><td>1-9</td><td>\$191.34</td></tr> <tr><td>10-24</td><td>\$181.77</td></tr> <tr><td>25-49</td><td>\$172.21</td></tr> <tr><td>PRECISION 50+</td><td>\$164.55</td></tr> </tbody> </table> <p><b>SMA Male to Full Detent Mini SMP Male</b> VSWR 1.2:1 to 26.5 GHz</p> <p>Model No: <a href="#">PE91052</a></p>	PRICE		1-9	\$191.34	10-24	\$181.77	25-49	\$172.21	PRECISION 50+	\$164.55	 <table border="1"> <thead> <tr><th colspan="2">PRICE</th></tr> </thead> <tbody> <tr><td>1-24</td><td>\$90.69</td></tr> <tr><td>25-49</td><td>\$86.16</td></tr> <tr><td>50-99</td><td>\$81.62</td></tr> <tr><td>100+</td><td>\$77.99</td></tr> </tbody> </table> <p><b>SMA Male to Mini SMP Female</b> VSWR 1.2:1 to 18 GHz</p> <p>Model No: <a href="#">PE91304</a></p>	PRICE		1-24	\$90.69	25-49	\$86.16	50-99	\$81.62	100+	\$77.99
	PRICE																																																						
1-24	\$104.58																																																						
25-49	\$99.35																																																						
50-99	\$94.12																																																						
100+	\$89.94																																																						
PRICE																																																							
1-24	\$89.02																																																						
25-49	\$84.57																																																						
50-99	\$80.12																																																						
100+	\$76.56																																																						
PRICE																																																							
1-24	\$100.77																																																						
25-49	\$95.73																																																						
50-99	\$90.69																																																						
100+	\$86.66																																																						
PRICE																																																							
1-9	\$191.34																																																						
10-24	\$181.77																																																						
25-49	\$172.21																																																						
PRECISION 50+	\$164.55																																																						
PRICE																																																							
1-24	\$90.69																																																						
25-49	\$86.16																																																						
50-99	\$81.62																																																						
100+	\$77.99																																																						
3	 <table border="1"> <thead> <tr><th colspan="2">PRICE</th></tr> </thead> <tbody> <tr><td>1-9</td><td>\$229.85</td></tr> <tr><td>10-24</td><td>\$218.36</td></tr> <tr><td>25-49</td><td>\$206.87</td></tr> <tr><td>PRECISION 50+</td><td>\$197.67</td></tr> </tbody> </table> <p><b>SMA Male to Mini SMP Female</b> VSWR 1.2:1 to 26.5 GHz</p> <p>Model No: <a href="#">PE91103</a></p>	PRICE		1-9	\$229.85	10-24	\$218.36	25-49	\$206.87	PRECISION 50+	\$197.67	 <table border="1"> <thead> <tr><th colspan="2">PRICE</th></tr> </thead> <tbody> <tr><td>1-9</td><td>\$127.83</td></tr> <tr><td>10-24</td><td>\$121.44</td></tr> <tr><td>25-49</td><td>\$115.05</td></tr> <tr><td>50+</td><td>\$109.93</td></tr> </tbody> </table> <p><b>SMA Male to MMCX Plug</b></p> <p>Model No: <a href="#">PE9476</a></p>	PRICE		1-9	\$127.83	10-24	\$121.44	25-49	\$115.05	50+	\$109.93	 <table border="1"> <thead> <tr><th colspan="2">PRICE</th></tr> </thead> <tbody> <tr><td>1-24</td><td>\$94.99</td></tr> <tr><td>25-49</td><td>\$90.24</td></tr> <tr><td>50-99</td><td>\$85.49</td></tr> <tr><td>100+</td><td>\$81.69</td></tr> </tbody> </table> <p><b>SMA Male to MMCX Jack</b></p> <p>Model No: <a href="#">PE9478</a></p>	PRICE		1-24	\$94.99	25-49	\$90.24	50-99	\$85.49	100+	\$81.69	 <table border="1"> <thead> <tr><th colspan="2">PRICE</th></tr> </thead> <tbody> <tr><td>1-9</td><td>\$201.74</td></tr> <tr><td>10-24</td><td>\$191.65</td></tr> <tr><td>25-49</td><td>\$181.57</td></tr> <tr><td>NEW 50+</td><td>\$173.50</td></tr> </tbody> </table> <p><b>SMA Male to Snap-On MMBX Plug</b> VSWR 1.2:1 to 12.4 GHz</p> <p>Model No: <a href="#">PE91360</a></p>	PRICE		1-9	\$201.74	10-24	\$191.65	25-49	\$181.57	NEW 50+	\$173.50	 <table border="1"> <thead> <tr><th colspan="2">PRICE</th></tr> </thead> <tbody> <tr><td>1-9</td><td>\$184.80</td></tr> <tr><td>10-24</td><td>\$175.56</td></tr> <tr><td>25-49</td><td>\$166.32</td></tr> <tr><td>NEW 50+</td><td>\$158.93</td></tr> </tbody> </table> <p><b>SMA Male to Snap-On MMBX Jack</b> VSWR 1.08:1 to 12.4 GHz</p> <p>Model No: <a href="#">PE91362</a></p>	PRICE		1-9	\$184.80	10-24	\$175.56	25-49	\$166.32	NEW 50+	\$158.93
	PRICE																																																						
1-9	\$229.85																																																						
10-24	\$218.36																																																						
25-49	\$206.87																																																						
PRECISION 50+	\$197.67																																																						
PRICE																																																							
1-9	\$127.83																																																						
10-24	\$121.44																																																						
25-49	\$115.05																																																						
50+	\$109.93																																																						
PRICE																																																							
1-24	\$94.99																																																						
25-49	\$90.24																																																						
50-99	\$85.49																																																						
100+	\$81.69																																																						
PRICE																																																							
1-9	\$201.74																																																						
10-24	\$191.65																																																						
25-49	\$181.57																																																						
NEW 50+	\$173.50																																																						
PRICE																																																							
1-9	\$184.80																																																						
10-24	\$175.56																																																						
25-49	\$166.32																																																						
NEW 50+	\$158.93																																																						
4	 <table border="1"> <thead> <tr><th colspan="2">PRICE</th></tr> </thead> <tbody> <tr><td>1-24</td><td>\$24.38</td></tr> <tr><td>25-49</td><td>\$23.16</td></tr> <tr><td>50-99</td><td>\$21.94</td></tr> <tr><td>100+</td><td>\$20.97</td></tr> </tbody> </table> <p><b>SMA Male to N Male</b> VSWR 1.3:1 to 11 GHz</p> <p>Model No: <a href="#">PE9080</a></p>	PRICE		1-24	\$24.38	25-49	\$23.16	50-99	\$21.94	100+	\$20.97	 <table border="1"> <thead> <tr><th colspan="2">PRICE</th></tr> </thead> <tbody> <tr><td>1-9</td><td>\$138.42</td></tr> <tr><td>10-24</td><td>\$131.50</td></tr> <tr><td>25-49</td><td>\$124.58</td></tr> <tr><td>PRECISION 50+</td><td>\$119.04</td></tr> </tbody> </table> <p><b>SMA Male to N Male</b> VSWR 1.15:1 to 18 GHz</p> <p>Model No: <a href="#">PE9431</a></p>	PRICE		1-9	\$138.42	10-24	\$131.50	25-49	\$124.58	PRECISION 50+	\$119.04	 <table border="1"> <thead> <tr><th colspan="2">PRICE</th></tr> </thead> <tbody> <tr><td>1-9</td><td>\$142.70</td></tr> <tr><td>10-24</td><td>\$135.57</td></tr> <tr><td>25-49</td><td>\$128.43</td></tr> <tr><td>PRECISION 50+</td><td>\$122.72</td></tr> </tbody> </table> <p><b>SMA Male to N Male 4 Hole Flange-Mounting Hole A05</b> VSWR 1.15:1 to 18 GHz</p> <p>Model No: <a href="#">PE9499</a></p>	PRICE		1-9	\$142.70	10-24	\$135.57	25-49	\$128.43	PRECISION 50+	\$122.72	 <table border="1"> <thead> <tr><th colspan="2">PRICE</th></tr> </thead> <tbody> <tr><td>1-24</td><td>\$22.87</td></tr> <tr><td>25-49</td><td>\$21.73</td></tr> <tr><td>50-99</td><td>\$20.58</td></tr> <tr><td>100+</td><td>\$19.67</td></tr> </tbody> </table> <p><b>SMA Male to N Female</b> VSWR 1.3:1 to 11 GHz</p> <p>Model No: <a href="#">PE9082</a></p>	PRICE		1-24	\$22.87	25-49	\$21.73	50-99	\$20.58	100+	\$19.67	 <table border="1"> <thead> <tr><th colspan="2">PRICE</th></tr> </thead> <tbody> <tr><td>1-24</td><td>\$102.64</td></tr> <tr><td>25-49</td><td>\$97.51</td></tr> <tr><td>50-99</td><td>\$92.38</td></tr> <tr><td>PRECISION 100+</td><td>\$88.27</td></tr> </tbody> </table> <p><b>SMA Male to N Female</b> VSWR 1.15:1 to 18 GHz</p> <p>Model No: <a href="#">PE9433</a></p>	PRICE		1-24	\$102.64	25-49	\$97.51	50-99	\$92.38	PRECISION 100+	\$88.27
	PRICE																																																						
1-24	\$24.38																																																						
25-49	\$23.16																																																						
50-99	\$21.94																																																						
100+	\$20.97																																																						
PRICE																																																							
1-9	\$138.42																																																						
10-24	\$131.50																																																						
25-49	\$124.58																																																						
PRECISION 50+	\$119.04																																																						
PRICE																																																							
1-9	\$142.70																																																						
10-24	\$135.57																																																						
25-49	\$128.43																																																						
PRECISION 50+	\$122.72																																																						
PRICE																																																							
1-24	\$22.87																																																						
25-49	\$21.73																																																						
50-99	\$20.58																																																						
100+	\$19.67																																																						
PRICE																																																							
1-24	\$102.64																																																						
25-49	\$97.51																																																						
50-99	\$92.38																																																						
PRECISION 100+	\$88.27																																																						
5	 <table border="1"> <thead> <tr><th colspan="2">PRICE</th></tr> </thead> <tbody> <tr><td>1-9</td><td>\$184.89</td></tr> <tr><td>10-24</td><td>\$175.65</td></tr> <tr><td>25-49</td><td>\$166.40</td></tr> <tr><td>PRECISION 50+</td><td>\$159.01</td></tr> </tbody> </table> <p><b>SMA Male to N Female Bulkhead</b> VSWR 1.15:1 to 18 GHz</p> <p>Model No: <a href="#">PE9487</a></p>	PRICE		1-9	\$184.89	10-24	\$175.65	25-49	\$166.40	PRECISION 50+	\$159.01	 <table border="1"> <thead> <tr><th colspan="2">PRICE</th></tr> </thead> <tbody> <tr><td>1-24</td><td>\$101.91</td></tr> <tr><td>25-49</td><td>\$96.81</td></tr> <tr><td>50-99</td><td>\$91.72</td></tr> <tr><td>100+</td><td>\$87.64</td></tr> </tbody> </table> <p><b>SMA Male to N Female 4 Hole Flange</b> VSWR 1.4:1 to 18 GHz</p> <p>Model No: <a href="#">PE9105</a></p>	PRICE		1-24	\$101.91	25-49	\$96.81	50-99	\$91.72	100+	\$87.64	 <table border="1"> <thead> <tr><th colspan="2">PRICE</th></tr> </thead> <tbody> <tr><td>1-9</td><td>\$196.20</td></tr> <tr><td>10-24</td><td>\$186.39</td></tr> <tr><td>25-49</td><td>\$176.58</td></tr> <tr><td>PRECISION 50+</td><td>\$168.73</td></tr> </tbody> </table> <p><b>SMA Male to N Female 4 Hole Flange</b> VSWR 1.15:1 to 18 GHz</p> <p>Model No: <a href="#">PE9497</a></p>	PRICE		1-9	\$196.20	10-24	\$186.39	25-49	\$176.58	PRECISION 50+	\$168.73	 <table border="1"> <thead> <tr><th colspan="2">PRICE</th></tr> </thead> <tbody> <tr><td>1-9</td><td>\$179.17</td></tr> <tr><td>10-24</td><td>\$170.21</td></tr> <tr><td>25-49</td><td>\$161.25</td></tr> <tr><td>PRECISION 50+</td><td>\$154.09</td></tr> </tbody> </table> <p><b>SMA Male to N Female Bulkhead</b> VSWR 1.15:1 to 18 GHz</p> <p>Model No: <a href="#">PE9488</a></p>	PRICE		1-9	\$179.17	10-24	\$170.21	25-49	\$161.25	PRECISION 50+	\$154.09	 <table border="1"> <thead> <tr><th colspan="2">PRICE</th></tr> </thead> <tbody> <tr><td>1-24</td><td>\$23.02</td></tr> <tr><td>25-49</td><td>\$22.10</td></tr> <tr><td>50-99</td><td>\$21.41</td></tr> <tr><td>NEW 100+</td><td>\$20.95</td></tr> </tbody> </table> <p><b>Push-On SMA Male to SMA Female</b> VSWR 1.5:1 to 18 GHz</p> <p>Model No: <a href="#">PE91336</a></p>	PRICE		1-24	\$23.02	25-49	\$22.10	50-99	\$21.41	NEW 100+	\$20.95
	PRICE																																																						
1-9	\$184.89																																																						
10-24	\$175.65																																																						
25-49	\$166.40																																																						
PRECISION 50+	\$159.01																																																						
PRICE																																																							
1-24	\$101.91																																																						
25-49	\$96.81																																																						
50-99	\$91.72																																																						
100+	\$87.64																																																						
PRICE																																																							
1-9	\$196.20																																																						
10-24	\$186.39																																																						
25-49	\$176.58																																																						
PRECISION 50+	\$168.73																																																						
PRICE																																																							
1-9	\$179.17																																																						
10-24	\$170.21																																																						
25-49	\$161.25																																																						
PRECISION 50+	\$154.09																																																						
PRICE																																																							
1-24	\$23.02																																																						
25-49	\$22.10																																																						
50-99	\$21.41																																																						
NEW 100+	\$20.95																																																						
6	 <table border="1"> <thead> <tr><th colspan="2">PRICE</th></tr> </thead> <tbody> <tr><td>1-24</td><td>\$88.98</td></tr> <tr><td>25-49</td><td>\$84.53</td></tr> <tr><td>50-99</td><td>\$80.08</td></tr> <tr><td>100+</td><td>\$76.52</td></tr> </tbody> </table> <p><b>SMA Male to SMB Plug</b> VSWR 1.25:1 to 4 GHz</p> <p>Model No: <a href="#">PE9144</a></p>	PRICE		1-24	\$88.98	25-49	\$84.53	50-99	\$80.08	100+	\$76.52	 <table border="1"> <thead> <tr><th colspan="2">PRICE</th></tr> </thead> <tbody> <tr><td>1-24</td><td>\$50.68</td></tr> <tr><td>25-49</td><td>\$48.15</td></tr> <tr><td>50-99</td><td>\$45.61</td></tr> <tr><td>100+</td><td>\$43.58</td></tr> </tbody> </table> <p><b>SMA Male to SMB Jack</b> VSWR 1.25:1 to 4 GHz</p> <p>Model No: <a href="#">PE9145</a></p>	PRICE		1-24	\$50.68	25-49	\$48.15	50-99	\$45.61	100+	\$43.58	 <table border="1"> <thead> <tr><th colspan="2">PRICE</th></tr> </thead> <tbody> <tr><td>1-24</td><td>\$70.85</td></tr> <tr><td>25-49</td><td>\$67.31</td></tr> <tr><td>50-99</td><td>\$63.77</td></tr> <tr><td>100+</td><td>\$60.93</td></tr> </tbody> </table> <p><b>SMA Male to SMC Plug</b> Max. Freq. 10 GHz</p> <p>Model No: <a href="#">PE9148</a></p>	PRICE		1-24	\$70.85	25-49	\$67.31	50-99	\$63.77	100+	\$60.93	 <table border="1"> <thead> <tr><th colspan="2">PRICE</th></tr> </thead> <tbody> <tr><td>1-24</td><td>\$60.54</td></tr> <tr><td>25-49</td><td>\$57.51</td></tr> <tr><td>50-99</td><td>\$54.49</td></tr> <tr><td>100+</td><td>\$52.06</td></tr> </tbody> </table> <p><b>SMA Male to SMC Jack</b> VSWR 1.2:1 to 10 GHz</p> <p>Model No: <a href="#">PE9149</a></p>	PRICE		1-24	\$60.54	25-49	\$57.51	50-99	\$54.49	100+	\$52.06	 <table border="1"> <thead> <tr><th colspan="2">PRICE</th></tr> </thead> <tbody> <tr><td>1-24</td><td>\$71.57</td></tr> <tr><td>25-49</td><td>\$67.99</td></tr> <tr><td>50-99</td><td>\$64.41</td></tr> <tr><td>100+</td><td>\$61.55</td></tr> </tbody> </table> <p><b>SMA Male to Full Detent SMP Male</b> VSWR 1.2:1 to 18 GHz</p> <p>Model No: <a href="#">PE91309</a></p>	PRICE		1-24	\$71.57	25-49	\$67.99	50-99	\$64.41	100+	\$61.55
	PRICE																																																						
1-24	\$88.98																																																						
25-49	\$84.53																																																						
50-99	\$80.08																																																						
100+	\$76.52																																																						
PRICE																																																							
1-24	\$50.68																																																						
25-49	\$48.15																																																						
50-99	\$45.61																																																						
100+	\$43.58																																																						
PRICE																																																							
1-24	\$70.85																																																						
25-49	\$67.31																																																						
50-99	\$63.77																																																						
100+	\$60.93																																																						
PRICE																																																							
1-24	\$60.54																																																						
25-49	\$57.51																																																						
50-99	\$54.49																																																						
100+	\$52.06																																																						
PRICE																																																							
1-24	\$71.57																																																						
25-49	\$67.99																																																						
50-99	\$64.41																																																						
100+	\$61.55																																																						
7	 <table border="1"> <thead> <tr><th colspan="2">PRICE</th></tr> </thead> <tbody> <tr><td>1-24</td><td>\$70.27</td></tr> <tr><td>25-49</td><td>\$66.76</td></tr> <tr><td>50-99</td><td>\$63.24</td></tr> <tr><td>100+</td><td>\$60.43</td></tr> </tbody> </table> <p><b>SMA Male to Limited Detent SMP Male</b> VSWR 1.2:1 to 18 GHz</p> <p>Model No: <a href="#">PE91310</a></p>	PRICE		1-24	\$70.27	25-49	\$66.76	50-99	\$63.24	100+	\$60.43	 <table border="1"> <thead> <tr><th colspan="2">PRICE</th></tr> </thead> <tbody> <tr><td>1-24</td><td>\$70.27</td></tr> <tr><td>25-49</td><td>\$66.76</td></tr> <tr><td>50-99</td><td>\$63.24</td></tr> <tr><td>100+</td><td>\$60.43</td></tr> </tbody> </table> <p><b>SMA Male to Smooth Bore SMP Male</b> VSWR 1.2:1 to 18 GHz</p> <p>Model No: <a href="#">PE91311</a></p>	PRICE		1-24	\$70.27	25-49	\$66.76	50-99	\$63.24	100+	\$60.43	 <table border="1"> <thead> <tr><th colspan="2">PRICE</th></tr> </thead> <tbody> <tr><td>1-9</td><td>\$126.71</td></tr> <tr><td>10-24</td><td>\$120.37</td></tr> <tr><td>25-49</td><td>\$114.04</td></tr> <tr><td>PRECISION 50+</td><td>\$108.97</td></tr> </tbody> </table> <p><b>SMA Male to Full Detent SMP Male</b> VSWR 1.2:1 to 26.5 GHz</p> <p>Model No: <a href="#">PE91063</a></p>	PRICE		1-9	\$126.71	10-24	\$120.37	25-49	\$114.04	PRECISION 50+	\$108.97	 <table border="1"> <thead> <tr><th colspan="2">PRICE</th></tr> </thead> <tbody> <tr><td>1-9</td><td>\$167.87</td></tr> <tr><td>10-24</td><td>\$159.48</td></tr> <tr><td>25-49</td><td>\$151.08</td></tr> <tr><td>PRECISION 50+</td><td>\$144.37</td></tr> </tbody> </table> <p><b>SMA Male to Limited Detent SMP Male</b> VSWR 1.2:1 to 18 GHz</p> <p>Model No: <a href="#">PE9511</a></p>	PRICE		1-9	\$167.87	10-24	\$159.48	25-49	\$151.08	PRECISION 50+	\$144.37	 <table border="1"> <thead> <tr><th colspan="2">PRICE</th></tr> </thead> <tbody> <tr><td>1-24</td><td>\$71.57</td></tr> <tr><td>25-49</td><td>\$67.99</td></tr> <tr><td>50-99</td><td>\$64.41</td></tr> <tr><td>100+</td><td>\$61.55</td></tr> </tbody> </table> <p><b>SMA Male to SMP Female</b> VSWR 1.2:1 to 18 GHz</p> <p>Model No: <a href="#">PE91312</a></p>	PRICE		1-24	\$71.57	25-49	\$67.99	50-99	\$64.41	100+	\$61.55
	PRICE																																																						
1-24	\$70.27																																																						
25-49	\$66.76																																																						
50-99	\$63.24																																																						
100+	\$60.43																																																						
PRICE																																																							
1-24	\$70.27																																																						
25-49	\$66.76																																																						
50-99	\$63.24																																																						
100+	\$60.43																																																						
PRICE																																																							
1-9	\$126.71																																																						
10-24	\$120.37																																																						
25-49	\$114.04																																																						
PRECISION 50+	\$108.97																																																						
PRICE																																																							
1-9	\$167.87																																																						
10-24	\$159.48																																																						
25-49	\$151.08																																																						
PRECISION 50+	\$144.37																																																						
PRICE																																																							
1-24	\$71.57																																																						
25-49	\$67.99																																																						
50-99	\$64.41																																																						
100+	\$61.55																																																						

# ADAPTERS

See Adapter Locator on Pages 8-13

See Page 369 for Mounting Holes

	A	B	C	D	E																																													
1	 <table border="1"> <thead> <tr> <th>PRICE</th> </tr> </thead> <tbody> <tr><td>1-9</td><td>\$157.28</td></tr> <tr><td>10-24</td><td>\$149.42</td></tr> <tr><td>25-49</td><td>\$141.55</td></tr> <tr><td>50+</td><td>\$135.26</td></tr> </tbody> </table> <p>PRECISION</p> <p>SMA Male to SMP Female</p> <p>VSWR 1.2:1 to 26.5 GHz</p> <p>Model No: <a href="#">PE91062</a></p>	PRICE	1-9	\$157.28	10-24	\$149.42	25-49	\$141.55	50+	\$135.26	 <table border="1"> <thead> <tr> <th>PRICE</th> </tr> </thead> <tbody> <tr><td>1-9</td><td>\$192.04</td></tr> <tr><td>10-24</td><td>\$182.44</td></tr> <tr><td>25-49</td><td>\$172.84</td></tr> <tr><td>50+</td><td>\$165.15</td></tr> </tbody> </table> <p>PRECISION</p> <p>SMA Male to SMP Female</p> <p>VSWR 1.2:1 to 18 GHz</p> <p>Model No: <a href="#">PE9513</a></p>	PRICE	1-9	\$192.04	10-24	\$182.44	25-49	\$172.84	50+	\$165.15	 <table border="1"> <thead> <tr> <th>PRICE</th> </tr> </thead> <tbody> <tr><td>1-24</td><td>\$100.70</td></tr> <tr><td>25-49</td><td>\$95.67</td></tr> <tr><td>50-99</td><td>\$90.63</td></tr> <tr><td>100+</td><td>\$86.60</td></tr> </tbody> </table> <p>SMA Male to SSMA Male</p> <p>VSWR 1.25:1 to 26.5 GHz</p> <p>Model No: <a href="#">PE9187</a></p>	PRICE	1-24	\$100.70	25-49	\$95.67	50-99	\$90.63	100+	\$86.60	 <table border="1"> <thead> <tr> <th>PRICE</th> </tr> </thead> <tbody> <tr><td>1-24</td><td>\$64.77</td></tr> <tr><td>25-49</td><td>\$61.53</td></tr> <tr><td>50-99</td><td>\$58.29</td></tr> <tr><td>100+</td><td>\$55.70</td></tr> </tbody> </table> <p>SMA Male to SSMA Female</p> <p>VSWR 1.4:1 to 18 GHz</p> <p>Model No: <a href="#">PE9063</a></p>	PRICE	1-24	\$64.77	25-49	\$61.53	50-99	\$58.29	100+	\$55.70	 <table border="1"> <thead> <tr> <th>PRICE</th> </tr> </thead> <tbody> <tr><td>1-24</td><td>\$89.29</td></tr> <tr><td>25-49</td><td>\$84.83</td></tr> <tr><td>50-99</td><td>\$80.36</td></tr> <tr><td>100+</td><td>\$76.79</td></tr> </tbody> </table> <p>SMA Male to SSMB Jack</p> <p>Model No: <a href="#">PE9401</a></p>	PRICE	1-24	\$89.29	25-49	\$84.83	50-99	\$80.36	100+	\$76.79
	PRICE																																																	
1-9	\$157.28																																																	
10-24	\$149.42																																																	
25-49	\$141.55																																																	
50+	\$135.26																																																	
PRICE																																																		
1-9	\$192.04																																																	
10-24	\$182.44																																																	
25-49	\$172.84																																																	
50+	\$165.15																																																	
PRICE																																																		
1-24	\$100.70																																																	
25-49	\$95.67																																																	
50-99	\$90.63																																																	
100+	\$86.60																																																	
PRICE																																																		
1-24	\$64.77																																																	
25-49	\$61.53																																																	
50-99	\$58.29																																																	
100+	\$55.70																																																	
PRICE																																																		
1-24	\$89.29																																																	
25-49	\$84.83																																																	
50-99	\$80.36																																																	
100+	\$76.79																																																	
2	 <table border="1"> <thead> <tr> <th>PRICE</th> </tr> </thead> <tbody> <tr><td>1-24</td><td>\$43.86</td></tr> <tr><td>25-49</td><td>\$41.67</td></tr> <tr><td>50-99</td><td>\$39.47</td></tr> <tr><td>100+</td><td>\$37.72</td></tr> </tbody> </table> <p>SMA Male to TNC Male</p> <p>Model No: <a href="#">PE9076</a></p>	PRICE	1-24	\$43.86	25-49	\$41.67	50-99	\$39.47	100+	\$37.72	 <table border="1"> <thead> <tr> <th>PRICE</th> </tr> </thead> <tbody> <tr><td>1-9</td><td>\$137.52</td></tr> <tr><td>10-24</td><td>\$130.64</td></tr> <tr><td>25-49</td><td>\$123.77</td></tr> <tr><td>50+</td><td>\$118.27</td></tr> </tbody> </table> <p>SMA Male to TNC Male</p> <p>VSWR 1.25:1 to 18 GHz</p> <p>Model No: <a href="#">PE9439</a></p>	PRICE	1-9	\$137.52	10-24	\$130.64	25-49	\$123.77	50+	\$118.27	 <table border="1"> <thead> <tr> <th>PRICE</th> </tr> </thead> <tbody> <tr><td>1-24</td><td>\$44.53</td></tr> <tr><td>25-49</td><td>\$42.30</td></tr> <tr><td>50-99</td><td>\$40.08</td></tr> <tr><td>100+</td><td>\$38.30</td></tr> </tbody> </table> <p>SMA Male to TNC Female</p> <p>VSWR 1.3:1 to 11 GHz</p> <p>Model No: <a href="#">PE9078</a></p>	PRICE	1-24	\$44.53	25-49	\$42.30	50-99	\$40.08	100+	\$38.30	<p><b>Ohm SMA Between Series</b></p> <p>→</p>		 <table border="1"> <thead> <tr> <th>PRICE</th> </tr> </thead> <tbody> <tr><td>1-24</td><td>\$110.13</td></tr> <tr><td>25-49</td><td>\$102.42</td></tr> <tr><td>50-99</td><td>\$94.71</td></tr> <tr><td>100+</td><td>\$88.10</td></tr> </tbody> </table> <p>SMA Male to TNC Female</p> <p>VSWR 1.2:1 to 18 GHz</p> <p>Model No: <a href="#">PE91507</a></p>	PRICE	1-24	\$110.13	25-49	\$102.42	50-99	\$94.71	100+	\$88.10								
	PRICE																																																	
1-24	\$43.86																																																	
25-49	\$41.67																																																	
50-99	\$39.47																																																	
100+	\$37.72																																																	
PRICE																																																		
1-9	\$137.52																																																	
10-24	\$130.64																																																	
25-49	\$123.77																																																	
50+	\$118.27																																																	
PRICE																																																		
1-24	\$44.53																																																	
25-49	\$42.30																																																	
50-99	\$40.08																																																	
100+	\$38.30																																																	
PRICE																																																		
1-24	\$110.13																																																	
25-49	\$102.42																																																	
50-99	\$94.71																																																	
100+	\$88.10																																																	
3	<p><b>SMA Between Series</b></p> <p>→</p>		 <table border="1"> <thead> <tr> <th>PRICE</th> </tr> </thead> <tbody> <tr><td>1-24</td><td>\$95.43</td></tr> <tr><td>25-49</td><td>\$90.66</td></tr> <tr><td>50-99</td><td>\$85.89</td></tr> <tr><td>100+</td><td>\$82.07</td></tr> </tbody> </table> <p>SMA Male to UHF Female</p> <p>Model No: <a href="#">PE9400</a></p>	PRICE	1-24	\$95.43	25-49	\$90.66	50-99	\$85.89	100+	\$82.07	 <table border="1"> <thead> <tr> <th>PRICE</th> </tr> </thead> <tbody> <tr><td>1-24</td><td>\$30.20</td></tr> <tr><td>25-49</td><td>\$28.69</td></tr> <tr><td>50-99</td><td>\$27.18</td></tr> <tr><td>100+</td><td>\$25.97</td></tr> </tbody> </table> <p>SMA Male to UMCX Jack</p> <p>VSWR 1.3:1 to 6 GHz</p> <p>Model No: <a href="#">PE91007</a></p>	PRICE	1-24	\$30.20	25-49	\$28.69	50-99	\$27.18	100+	\$25.97	 <table border="1"> <thead> <tr> <th>PRICE</th> </tr> </thead> <tbody> <tr><td>1-24</td><td>\$97.00</td></tr> <tr><td>25-49</td><td>\$92.15</td></tr> <tr><td>50-99</td><td>\$87.30</td></tr> <tr><td>100+</td><td>\$83.42</td></tr> </tbody> </table> <p>SMA Female to 1.0/2.3 Plug</p> <p>Model No: <a href="#">PE9691</a></p>	PRICE	1-24	\$97.00	25-49	\$92.15	50-99	\$87.30	100+	\$83.42																		
	PRICE																																																	
1-24	\$95.43																																																	
25-49	\$90.66																																																	
50-99	\$85.89																																																	
100+	\$82.07																																																	
PRICE																																																		
1-24	\$30.20																																																	
25-49	\$28.69																																																	
50-99	\$27.18																																																	
100+	\$25.97																																																	
PRICE																																																		
1-24	\$97.00																																																	
25-49	\$92.15																																																	
50-99	\$87.30																																																	
100+	\$83.42																																																	
4	 <table border="1"> <thead> <tr> <th>PRICE</th> </tr> </thead> <tbody> <tr><td>1-24</td><td>\$84.56</td></tr> <tr><td>25-49</td><td>\$80.33</td></tr> <tr><td>50-99</td><td>\$76.10</td></tr> <tr><td>100+</td><td>\$72.72</td></tr> </tbody> </table> <p>SMA Female to 1.0/2.3 Jack</p> <p>Model No: <a href="#">PE9693</a></p>	PRICE	1-24	\$84.56	25-49	\$80.33	50-99	\$76.10	100+	\$72.72	 <table border="1"> <thead> <tr> <th>PRICE</th> </tr> </thead> <tbody> <tr><td>1-9</td><td>\$210.40</td></tr> <tr><td>10-24</td><td>\$199.88</td></tr> <tr><td>25-49</td><td>\$189.36</td></tr> <tr><td>50+</td><td>\$180.94</td></tr> </tbody> </table> <p>SMA Female to 1.85mm Male</p> <p>VSWR 1.3:1 to 18 GHz</p> <p>Model No: <a href="#">PE9726</a></p>	PRICE	1-9	\$210.40	10-24	\$199.88	25-49	\$189.36	50+	\$180.94	 <table border="1"> <thead> <tr> <th>PRICE</th> </tr> </thead> <tbody> <tr><td>1-9</td><td>\$217.27</td></tr> <tr><td>10-24</td><td>\$206.41</td></tr> <tr><td>25-49</td><td>\$195.54</td></tr> <tr><td>50+</td><td>\$186.85</td></tr> </tbody> </table> <p>SMA Female to 1.85mm Female</p> <p>VSWR 1.3:1 to 18 GHz</p> <p>Model No: <a href="#">PE9729</a></p>	PRICE	1-9	\$217.27	10-24	\$206.41	25-49	\$195.54	50+	\$186.85	 <table border="1"> <thead> <tr> <th>PRICE</th> </tr> </thead> <tbody> <tr><td>1-9</td><td>\$214.32</td></tr> <tr><td>10-24</td><td>\$203.60</td></tr> <tr><td>25-49</td><td>\$192.89</td></tr> <tr><td>50+</td><td>\$184.32</td></tr> </tbody> </table> <p>SMA Female to 2.4mm Male</p> <p>VSWR 1.2:1 to 27 GHz</p> <p>Model No: <a href="#">PE9655</a></p>	PRICE	1-9	\$214.32	10-24	\$203.60	25-49	\$192.89	50+	\$184.32	 <table border="1"> <thead> <tr> <th>PRICE</th> </tr> </thead> <tbody> <tr><td>1-9</td><td>\$220.01</td></tr> <tr><td>10-24</td><td>\$209.01</td></tr> <tr><td>25-49</td><td>\$198.01</td></tr> <tr><td>50+</td><td>\$189.21</td></tr> </tbody> </table> <p>PRECISION</p> <p>SMA Female to 2.4mm Female</p> <p>VSWR 1.2:1 to 26.5 GHz</p> <p>Model No: <a href="#">PE9656</a></p>	PRICE	1-9	\$220.01	10-24	\$209.01	25-49	\$198.01	50+	\$189.21
	PRICE																																																	
1-24	\$84.56																																																	
25-49	\$80.33																																																	
50-99	\$76.10																																																	
100+	\$72.72																																																	
PRICE																																																		
1-9	\$210.40																																																	
10-24	\$199.88																																																	
25-49	\$189.36																																																	
50+	\$180.94																																																	
PRICE																																																		
1-9	\$217.27																																																	
10-24	\$206.41																																																	
25-49	\$195.54																																																	
50+	\$186.85																																																	
PRICE																																																		
1-9	\$214.32																																																	
10-24	\$203.60																																																	
25-49	\$192.89																																																	
50+	\$184.32																																																	
PRICE																																																		
1-9	\$220.01																																																	
10-24	\$209.01																																																	
25-49	\$198.01																																																	
50+	\$189.21																																																	
5	 <table border="1"> <thead> <tr> <th>PRICE</th> </tr> </thead> <tbody> <tr><td>1-9</td><td>\$207.05</td></tr> <tr><td>10-24</td><td>\$196.70</td></tr> <tr><td>25-49</td><td>\$186.35</td></tr> <tr><td>50+</td><td>\$178.06</td></tr> </tbody> </table> <p>PRECISION</p> <p>SMA Female to 2.92mm Male</p> <p>VSWR 1.2:1 to 26.5 GHz</p> <p>Model No: <a href="#">PE91009</a></p>	PRICE	1-9	\$207.05	10-24	\$196.70	25-49	\$186.35	50+	\$178.06	 <table border="1"> <thead> <tr> <th>PRICE</th> </tr> </thead> <tbody> <tr><td>1-9</td><td>\$211.08</td></tr> <tr><td>10-24</td><td>\$200.53</td></tr> <tr><td>25-49</td><td>\$189.97</td></tr> <tr><td>50+</td><td>\$181.53</td></tr> </tbody> </table> <p>PRECISION</p> <p>SMA Female to 2.92mm Female</p> <p>VSWR 1.2:1 to 26.5 GHz</p> <p>Model No: <a href="#">PE91011</a></p>	PRICE	1-9	\$211.08	10-24	\$200.53	25-49	\$189.97	50+	\$181.53	 <table border="1"> <thead> <tr> <th>PRICE</th> </tr> </thead> <tbody> <tr><td>1-9</td><td>\$193.10</td></tr> <tr><td>10-24</td><td>\$183.45</td></tr> <tr><td>25-49</td><td>\$173.79</td></tr> <tr><td>50+</td><td>\$166.07</td></tr> </tbody> </table> <p>SMA Female to 3.5mm Male</p> <p>VSWR 1.2:1 to 27 GHz</p> <p>Model No: <a href="#">PE9724</a></p>	PRICE	1-9	\$193.10	10-24	\$183.45	25-49	\$173.79	50+	\$166.07	 <table border="1"> <thead> <tr> <th>PRICE</th> </tr> </thead> <tbody> <tr><td>1-9</td><td>\$198.70</td></tr> <tr><td>10-24</td><td>\$188.77</td></tr> <tr><td>25-49</td><td>\$178.83</td></tr> <tr><td>50+</td><td>\$170.88</td></tr> </tbody> </table> <p>SMA Female to 3.5mm Female</p> <p>VSWR 1.2:1 to 27 GHz</p> <p>Model No: <a href="#">PE9725</a></p>	PRICE	1-9	\$198.70	10-24	\$188.77	25-49	\$178.83	50+	\$170.88	 <table border="1"> <thead> <tr> <th>PRICE</th> </tr> </thead> <tbody> <tr><td>1-9</td><td>\$235.28</td></tr> <tr><td>10-24</td><td>\$223.52</td></tr> <tr><td>25-49</td><td>\$211.75</td></tr> <tr><td>50+</td><td>\$202.34</td></tr> </tbody> </table> <p>PRECISION</p> <p>SMA Female to 7mm Sexless</p> <p>VSWR 1.15:1 to 18 GHz</p> <p>Model No: <a href="#">PE9214</a></p>	PRICE	1-9	\$235.28	10-24	\$223.52	25-49	\$211.75	50+	\$202.34
	PRICE																																																	
1-9	\$207.05																																																	
10-24	\$196.70																																																	
25-49	\$186.35																																																	
50+	\$178.06																																																	
PRICE																																																		
1-9	\$211.08																																																	
10-24	\$200.53																																																	
25-49	\$189.97																																																	
50+	\$181.53																																																	
PRICE																																																		
1-9	\$193.10																																																	
10-24	\$183.45																																																	
25-49	\$173.79																																																	
50+	\$166.07																																																	
PRICE																																																		
1-9	\$198.70																																																	
10-24	\$188.77																																																	
25-49	\$178.83																																																	
50+	\$170.88																																																	
PRICE																																																		
1-9	\$235.28																																																	
10-24	\$223.52																																																	
25-49	\$211.75																																																	
50+	\$202.34																																																	
6	 <table border="1"> <thead> <tr> <th>PRICE</th> </tr> </thead> <tbody> <tr><td>1-4</td><td>\$585.14</td></tr> <tr><td>5-9</td><td>\$555.88</td></tr> <tr><td>10-24</td><td>\$526.63</td></tr> <tr><td>25+</td><td>\$503.22</td></tr> </tbody> </table> <p>PRECISION</p> <p>SMA Female to 7mm Sexless 4 Hole Flange-Mounting Hole A05</p> <p>VSWR 1.15:1 to 18 GHz</p> <p>Model No: <a href="#">PE9327</a></p>	PRICE	1-4	\$585.14	5-9	\$555.88	10-24	\$526.63	25+	\$503.22	 <table border="1"> <thead> <tr> <th>PRICE</th> </tr> </thead> <tbody> <tr><td>1-24</td><td>\$90.94</td></tr> <tr><td>25-49</td><td>\$86.39</td></tr> <tr><td>50-99</td><td>\$81.85</td></tr> <tr><td>100+</td><td>\$78.21</td></tr> </tbody> </table> <p>Low PIM</p> <p>SMA Female to 7/16 DIN Male</p> <p>VSWR 1.09:1 to 7.5 GHz</p> <p>Model No: <a href="#">PE91036</a></p>	PRICE	1-24	\$90.94	25-49	\$86.39	50-99	\$81.85	100+	\$78.21	 <table border="1"> <thead> <tr> <th>PRICE</th> </tr> </thead> <tbody> <tr><td>1-9</td><td>\$114.30</td></tr> <tr><td>10-24</td><td>\$108.59</td></tr> <tr><td>25-49</td><td>\$102.87</td></tr> <tr><td>50+</td><td>\$98.30</td></tr> </tbody> </table> <p>SMA Female to 7/16 DIN Male</p> <p>VSWR 1.25:1 to 6 GHz</p> <p>Model No: <a href="#">PE91175</a></p>	PRICE	1-9	\$114.30	10-24	\$108.59	25-49	\$102.87	50+	\$98.30	 <table border="1"> <thead> <tr> <th>PRICE</th> </tr> </thead> <tbody> <tr><td>1-24</td><td>\$91.69</td></tr> <tr><td>25-49</td><td>\$87.11</td></tr> <tr><td>50-99</td><td>\$82.52</td></tr> <tr><td>100+</td><td>\$78.85</td></tr> </tbody> </table> <p>Low PIM</p> <p>SMA Female to 7/16 DIN Female</p> <p>Max. Freq. 8 GHz</p> <p>Model No: <a href="#">PE91042</a></p>	PRICE	1-24	\$91.69	25-49	\$87.11	50-99	\$82.52	100+	\$78.85	 <table border="1"> <thead> <tr> <th>PRICE</th> </tr> </thead> <tbody> <tr><td>1-24</td><td>\$21.16</td></tr> <tr><td>25-49</td><td>\$20.10</td></tr> <tr><td>50-99</td><td>\$19.04</td></tr> <tr><td>100+</td><td>\$18.20</td></tr> </tbody> </table> <p>SMA Female to BNC Male</p> <p>VSWR 1.3:1 to 4 GHz</p> <p>Model No: <a href="#">PE9073</a></p>	PRICE	1-24	\$21.16	25-49	\$20.10	50-99	\$19.04	100+	\$18.20
	PRICE																																																	
1-4	\$585.14																																																	
5-9	\$555.88																																																	
10-24	\$526.63																																																	
25+	\$503.22																																																	
PRICE																																																		
1-24	\$90.94																																																	
25-49	\$86.39																																																	
50-99	\$81.85																																																	
100+	\$78.21																																																	
PRICE																																																		
1-9	\$114.30																																																	
10-24	\$108.59																																																	
25-49	\$102.87																																																	
50+	\$98.30																																																	
PRICE																																																		
1-24	\$91.69																																																	
25-49	\$87.11																																																	
50-99	\$82.52																																																	
100+	\$78.85																																																	
PRICE																																																		
1-24	\$21.16																																																	
25-49	\$20.10																																																	
50-99	\$19.04																																																	
100+	\$18.20																																																	
7	 <table border="1"> <thead> <tr> <th>PRICE</th> </tr> </thead> <tbody> <tr><td>1-24</td><td>\$80.63</td></tr> <tr><td>25-49</td><td>\$76.60</td></tr> <tr><td>50-99</td><td>\$72.57</td></tr> <tr><td>100+</td><td>\$69.34</td></tr> </tbody> </table> <p>SMA Female to BNC Male</p> <p>VSWR 1.25:1 to 8 GHz</p> <p>Model No: <a href="#">PE9494</a></p>	PRICE	1-24	\$80.63	25-49	\$76.60	50-99	\$72.57	100+	\$69.34	 <table border="1"> <thead> <tr> <th>PRICE</th> </tr> </thead> <tbody> <tr><td>1-24</td><td>\$45.58</td></tr> <tr><td>25-49</td><td>\$43.30</td></tr> <tr><td>50-99</td><td>\$41.02</td></tr> <tr><td>100+</td><td>\$39.20</td></tr> </tbody> </table> <p>SMA Female to BNC Female</p> <p>VSWR 1.3:1 to 4 GHz</p> <p>Model No: <a href="#">PE9075</a></p>	PRICE	1-24	\$45.58	25-49	\$43.30	50-99	\$41.02	100+	\$39.20	 <table border="1"> <thead> <tr> <th>PRICE</th> </tr> </thead> <tbody> <tr><td>1-24</td><td>\$113.61</td></tr> <tr><td>25-49</td><td>\$107.93</td></tr> <tr><td>50-99</td><td>\$102.25</td></tr> <tr><td>100+</td><td>\$97.70</td></tr> </tbody> </table> <p>SMA Female to BNC Female</p> <p>VSWR 1.25:1 to 8 GHz</p> <p>Model No: <a href="#">PE9496</a></p>	PRICE	1-24	\$113.61	25-49	\$107.93	50-99	\$102.25	100+	\$97.70	 <table border="1"> <thead> <tr> <th>PRICE</th> </tr> </thead> <tbody> <tr><td>1-24</td><td>\$55.75</td></tr> <tr><td>25-49</td><td>\$52.96</td></tr> <tr><td>50-99</td><td>\$50.18</td></tr> <tr><td>100+</td><td>\$47.95</td></tr> </tbody> </table> <p>SMA Female to BNC Female Bulkhead</p> <p>Max. Freq. 4 GHz</p> <p>Model No: <a href="#">PE9185</a></p>	PRICE	1-24	\$55.75	25-49	\$52.96	50-99	\$50.18	100+	\$47.95	 <table border="1"> <thead> <tr> <th>PRICE</th> </tr> </thead> <tbody> <tr><td>1-24</td><td>\$64.59</td></tr> <tr><td>25-49</td><td>\$61.36</td></tr> <tr><td>50-99</td><td>\$58.13</td></tr> <tr><td>100+</td><td>\$55.55</td></tr> </tbody> </table> <p>SMA Female to BNC Female Bulkhead</p> <p>Max. Freq. 4 GHz</p> <p>Model No: <a href="#">PE9407</a></p>	PRICE	1-24	\$64.59	25-49	\$61.36	50-99	\$58.13	100+	\$55.55
	PRICE																																																	
1-24	\$80.63																																																	
25-49	\$76.60																																																	
50-99	\$72.57																																																	
100+	\$69.34																																																	
PRICE																																																		
1-24	\$45.58																																																	
25-49	\$43.30																																																	
50-99	\$41.02																																																	
100+	\$39.20																																																	
PRICE																																																		
1-24	\$113.61																																																	
25-49	\$107.93																																																	
50-99	\$102.25																																																	
100+	\$97.70																																																	
PRICE																																																		
1-24	\$55.75																																																	
25-49	\$52.96																																																	
50-99	\$50.18																																																	
100+	\$47.95																																																	
PRICE																																																		
1-24	\$64.59																																																	
25-49	\$61.36																																																	
50-99	\$58.13																																																	
100+	\$55.55																																																	



Technical Support  
+1 (949) 261-1920



Same-Day Shipping,  
Even Custom  
Cable Assemblies

# ADAPTERS

See Adapter Locator on Pages 8-13

See Page 369 for Mounting Holes

	A	B	C	D	E																																																		
1	 <table border="1"> <thead> <tr> <th colspan="2">PRICE</th> </tr> </thead> <tbody> <tr> <td>1-24</td> <td>\$26.54</td> </tr> <tr> <td>25-49</td> <td>\$25.21</td> </tr> <tr> <td>50-99</td> <td>\$23.89</td> </tr> <tr> <td>100+</td> <td>\$22.82</td> </tr> </tbody> </table> <p>SMA Female to 75 Ohm F Male VSWR 1.5:1 to 500 MHz</p> <p>Model No: <a href="#">PE91045</a></p>	PRICE		1-24	\$26.54	25-49	\$25.21	50-99	\$23.89	100+	\$22.82	 <table border="1"> <thead> <tr> <th colspan="2">PRICE</th> </tr> </thead> <tbody> <tr> <td>1-24</td> <td>\$55.82</td> </tr> <tr> <td>25-49</td> <td>\$53.03</td> </tr> <tr> <td>50-99</td> <td>\$50.24</td> </tr> <tr> <td>100+</td> <td>\$48.01</td> </tr> </tbody> </table> <p>SMA Female to 75 Ohm F Female</p> <p>Model No: <a href="#">PE91002</a></p>	PRICE		1-24	\$55.82	25-49	\$53.03	50-99	\$50.24	100+	\$48.01	 <table border="1"> <thead> <tr> <th colspan="2">PRICE</th> </tr> </thead> <tbody> <tr> <td>1-24</td> <td>\$21.23</td> </tr> <tr> <td>25-49</td> <td>\$20.17</td> </tr> <tr> <td>50-99</td> <td>\$19.11</td> </tr> <tr> <td>100+</td> <td>\$18.26</td> </tr> </tbody> </table> <p>SMA Female to FME Plug</p> <p>Model No: <a href="#">PE9703</a></p>	PRICE		1-24	\$21.23	25-49	\$20.17	50-99	\$19.11	100+	\$18.26	 <table border="1"> <thead> <tr> <th colspan="2">PRICE</th> </tr> </thead> <tbody> <tr> <td>1-24</td> <td>\$27.44</td> </tr> <tr> <td>25-49</td> <td>\$26.07</td> </tr> <tr> <td>50-99</td> <td>\$24.70</td> </tr> <tr> <td>100+</td> <td>\$23.60</td> </tr> </tbody> </table> <p>SMA Female to FME Jack VSWR 1.3:1 to 900 MHz</p> <p>Model No: <a href="#">PE9708</a></p>	PRICE		1-24	\$27.44	25-49	\$26.07	50-99	\$24.70	100+	\$23.60	 <table border="1"> <thead> <tr> <th colspan="2">PRICE</th> </tr> </thead> <tbody> <tr> <td>1-9</td> <td>\$182.70</td> </tr> <tr> <td>10-24</td> <td>\$173.57</td> </tr> <tr> <td>25-49</td> <td>\$164.43</td> </tr> <tr> <td>50+</td> <td>\$157.12</td> </tr> </tbody> </table> <p>SMA Female to GR874 Sexless</p> <p>Model No: <a href="#">PE9260</a></p>	PRICE		1-9	\$182.70	10-24	\$173.57	25-49	\$164.43	50+	\$157.12
	PRICE																																																						
1-24	\$26.54																																																						
25-49	\$25.21																																																						
50-99	\$23.89																																																						
100+	\$22.82																																																						
PRICE																																																							
1-24	\$55.82																																																						
25-49	\$53.03																																																						
50-99	\$50.24																																																						
100+	\$48.01																																																						
PRICE																																																							
1-24	\$21.23																																																						
25-49	\$20.17																																																						
50-99	\$19.11																																																						
100+	\$18.26																																																						
PRICE																																																							
1-24	\$27.44																																																						
25-49	\$26.07																																																						
50-99	\$24.70																																																						
100+	\$23.60																																																						
PRICE																																																							
1-9	\$182.70																																																						
10-24	\$173.57																																																						
25-49	\$164.43																																																						
50+	\$157.12																																																						
2	 <table border="1"> <thead> <tr> <th colspan="2">PRICE</th> </tr> </thead> <tbody> <tr> <td>1-24</td> <td>\$83.56</td> </tr> <tr> <td>25-49</td> <td>\$79.38</td> </tr> <tr> <td>50-99</td> <td>\$75.20</td> </tr> <tr> <td>100+</td> <td>\$71.86</td> </tr> </tbody> </table> <p>SMA Female to HN Male Max. Freq. 4 GHz</p> <p>Model No: <a href="#">PE9253</a></p>	PRICE		1-24	\$83.56	25-49	\$79.38	50-99	\$75.20	100+	\$71.86	 <table border="1"> <thead> <tr> <th colspan="2">PRICE</th> </tr> </thead> <tbody> <tr> <td>1-24</td> <td>\$68.50</td> </tr> <tr> <td>25-49</td> <td>\$65.08</td> </tr> <tr> <td>50-99</td> <td>\$61.65</td> </tr> <tr> <td>100+</td> <td>\$58.91</td> </tr> </tbody> </table> <p>SMA Female to HN Female</p> <p>Model No: <a href="#">PE9255</a></p>	PRICE		1-24	\$68.50	25-49	\$65.08	50-99	\$61.65	100+	\$58.91	 <table border="1"> <thead> <tr> <th colspan="2">PRICE</th> </tr> </thead> <tbody> <tr> <td>1-24</td> <td>\$82.36</td> </tr> <tr> <td>25-49</td> <td>\$78.24</td> </tr> <tr> <td>50-99</td> <td>\$74.12</td> </tr> <tr> <td>100+</td> <td>\$70.83</td> </tr> </tbody> </table> <p>SMA Female to MCX Plug</p> <p>Model No: <a href="#">PE9471</a></p>	PRICE		1-24	\$82.36	25-49	\$78.24	50-99	\$74.12	100+	\$70.83	 <table border="1"> <thead> <tr> <th colspan="2">PRICE</th> </tr> </thead> <tbody> <tr> <td>1-24</td> <td>\$80.98</td> </tr> <tr> <td>25-49</td> <td>\$76.93</td> </tr> <tr> <td>50-99</td> <td>\$72.88</td> </tr> <tr> <td>100+</td> <td>\$69.64</td> </tr> </tbody> </table> <p>SMA Female to MCX Jack</p> <p>Model No: <a href="#">PE9470</a></p>	PRICE		1-24	\$80.98	25-49	\$76.93	50-99	\$72.88	100+	\$69.64	 <table border="1"> <thead> <tr> <th colspan="2">PRICE</th> </tr> </thead> <tbody> <tr> <td>1-24</td> <td>\$90.69</td> </tr> <tr> <td>25-49</td> <td>\$86.16</td> </tr> <tr> <td>50-99</td> <td>\$81.62</td> </tr> <tr> <td>100+</td> <td>\$77.99</td> </tr> </tbody> </table> <p>SMA Female to Full Detent Mini SMP Male VSWR 1.2:1 to 18 GHz</p> <p>Model No: <a href="#">PE91299</a></p>	PRICE		1-24	\$90.69	25-49	\$86.16	50-99	\$81.62	100+	\$77.99
	PRICE																																																						
1-24	\$83.56																																																						
25-49	\$79.38																																																						
50-99	\$75.20																																																						
100+	\$71.86																																																						
PRICE																																																							
1-24	\$68.50																																																						
25-49	\$65.08																																																						
50-99	\$61.65																																																						
100+	\$58.91																																																						
PRICE																																																							
1-24	\$82.36																																																						
25-49	\$78.24																																																						
50-99	\$74.12																																																						
100+	\$70.83																																																						
PRICE																																																							
1-24	\$80.98																																																						
25-49	\$76.93																																																						
50-99	\$72.88																																																						
100+	\$69.64																																																						
PRICE																																																							
1-24	\$90.69																																																						
25-49	\$86.16																																																						
50-99	\$81.62																																																						
100+	\$77.99																																																						
3	 <table border="1"> <thead> <tr> <th colspan="2">PRICE</th> </tr> </thead> <tbody> <tr> <td>1-9</td> <td>\$175.00</td> </tr> <tr> <td>10-24</td> <td>\$166.25</td> </tr> <tr> <td>25-49</td> <td>\$157.50</td> </tr> <tr> <td>50+</td> <td>\$150.50</td> </tr> </tbody> </table> <p>SMA Female to Full Detent Mini SMP Male VSWR 1.2:1 to 26.5 GHz</p> <p>Model No: <a href="#">PE91129</a></p>	PRICE		1-9	\$175.00	10-24	\$166.25	25-49	\$157.50	50+	\$150.50	 <table border="1"> <thead> <tr> <th colspan="2">PRICE</th> </tr> </thead> <tbody> <tr> <td>1-24</td> <td>\$100.77</td> </tr> <tr> <td>25-49</td> <td>\$95.73</td> </tr> <tr> <td>50-99</td> <td>\$90.69</td> </tr> <tr> <td>100+</td> <td>\$86.66</td> </tr> </tbody> </table> <p>SMA Female to Smooth Bore Mini SMP Male VSWR 1.2:1 to 18 GHz</p> <p>Model No: <a href="#">PE91300</a></p>	PRICE		1-24	\$100.77	25-49	\$95.73	50-99	\$90.69	100+	\$86.66	 <table border="1"> <thead> <tr> <th colspan="2">PRICE</th> </tr> </thead> <tbody> <tr> <td>1-24</td> <td>\$89.85</td> </tr> <tr> <td>25-49</td> <td>\$85.36</td> </tr> <tr> <td>50-99</td> <td>\$80.87</td> </tr> <tr> <td>100+</td> <td>\$77.27</td> </tr> </tbody> </table> <p>SMA Female to Mini SMP Female VSWR 1.2:1 to 18 GHz</p> <p>Model No: <a href="#">PE91301</a></p>	PRICE		1-24	\$89.85	25-49	\$85.36	50-99	\$80.87	100+	\$77.27	 <table border="1"> <thead> <tr> <th colspan="2">PRICE</th> </tr> </thead> <tbody> <tr> <td>1-9</td> <td>\$157.83</td> </tr> <tr> <td>10-24</td> <td>\$149.94</td> </tr> <tr> <td>25-49</td> <td>\$142.05</td> </tr> <tr> <td>50+</td> <td>\$135.73</td> </tr> </tbody> </table> <p>PRECISION SMA Female to Mini SMP Female VSWR 1.2:1 to 26.5 GHz</p> <p>Model No: <a href="#">PE91051</a></p>	PRICE		1-9	\$157.83	10-24	\$149.94	25-49	\$142.05	50+	\$135.73	 <table border="1"> <thead> <tr> <th colspan="2">PRICE</th> </tr> </thead> <tbody> <tr> <td>1-24</td> <td>\$92.95</td> </tr> <tr> <td>25-49</td> <td>\$88.30</td> </tr> <tr> <td>50-99</td> <td>\$83.66</td> </tr> <tr> <td>100+</td> <td>\$79.94</td> </tr> </tbody> </table> <p>SMA Female to MMCX Plug</p> <p>Model No: <a href="#">PE9475</a></p>	PRICE		1-24	\$92.95	25-49	\$88.30	50-99	\$83.66	100+	\$79.94
	PRICE																																																						
1-9	\$175.00																																																						
10-24	\$166.25																																																						
25-49	\$157.50																																																						
50+	\$150.50																																																						
PRICE																																																							
1-24	\$100.77																																																						
25-49	\$95.73																																																						
50-99	\$90.69																																																						
100+	\$86.66																																																						
PRICE																																																							
1-24	\$89.85																																																						
25-49	\$85.36																																																						
50-99	\$80.87																																																						
100+	\$77.27																																																						
PRICE																																																							
1-9	\$157.83																																																						
10-24	\$149.94																																																						
25-49	\$142.05																																																						
50+	\$135.73																																																						
PRICE																																																							
1-24	\$92.95																																																						
25-49	\$88.30																																																						
50-99	\$83.66																																																						
100+	\$79.94																																																						
4	 <table border="1"> <thead> <tr> <th colspan="2">PRICE</th> </tr> </thead> <tbody> <tr> <td>1-24</td> <td>\$84.80</td> </tr> <tr> <td>25-49</td> <td>\$80.56</td> </tr> <tr> <td>50-99</td> <td>\$76.32</td> </tr> <tr> <td>100+</td> <td>\$72.93</td> </tr> </tbody> </table> <p>SMA Female to MMCX Jack</p> <p>Model No: <a href="#">PE9477</a></p>	PRICE		1-24	\$84.80	25-49	\$80.56	50-99	\$76.32	100+	\$72.93	 <table border="1"> <thead> <tr> <th colspan="2">PRICE</th> </tr> </thead> <tbody> <tr> <td>1-9</td> <td>\$195.38</td> </tr> <tr> <td>10-24</td> <td>\$185.61</td> </tr> <tr> <td>25-49</td> <td>\$175.84</td> </tr> <tr> <td>50+</td> <td>\$168.03</td> </tr> </tbody> </table> <p>NEW SMA Female to Snap-On MMBX Plug VSWR 1.08:1 to 12.4 GHz</p> <p>Model No: <a href="#">PE91361</a></p>	PRICE		1-9	\$195.38	10-24	\$185.61	25-49	\$175.84	50+	\$168.03	 <table border="1"> <thead> <tr> <th colspan="2">PRICE</th> </tr> </thead> <tbody> <tr> <td>1-9</td> <td>\$177.22</td> </tr> <tr> <td>10-24</td> <td>\$168.36</td> </tr> <tr> <td>25-49</td> <td>\$159.50</td> </tr> <tr> <td>50+</td> <td>\$152.41</td> </tr> </tbody> </table> <p>NEW SMA Female to Snap-On MMBX Jack VSWR 1.08:1 to 12.4 GHz</p> <p>Model No: <a href="#">PE91363</a></p>	PRICE		1-9	\$177.22	10-24	\$168.36	25-49	\$159.50	50+	\$152.41	 <table border="1"> <thead> <tr> <th colspan="2">PRICE</th> </tr> </thead> <tbody> <tr> <td>1-24</td> <td>\$16.99</td> </tr> <tr> <td>25-49</td> <td>\$16.14</td> </tr> <tr> <td>50-99</td> <td>\$15.29</td> </tr> <tr> <td>100+</td> <td>\$14.61</td> </tr> </tbody> </table> <p>SMA Female to N Male VSWR 1.3:1 to 11 GHz</p> <p>Model No: <a href="#">PE9081</a></p>	PRICE		1-24	\$16.99	25-49	\$16.14	50-99	\$15.29	100+	\$14.61	 <table border="1"> <thead> <tr> <th colspan="2">PRICE</th> </tr> </thead> <tbody> <tr> <td>1-9</td> <td>\$205.73</td> </tr> <tr> <td>10-24</td> <td>\$195.44</td> </tr> <tr> <td>25-49</td> <td>\$185.16</td> </tr> <tr> <td>50+</td> <td>\$176.93</td> </tr> </tbody> </table> <p>SMA Female to QD N Male</p> <p>Model No: <a href="#">PE9684</a></p>	PRICE		1-9	\$205.73	10-24	\$195.44	25-49	\$185.16	50+	\$176.93
	PRICE																																																						
1-24	\$84.80																																																						
25-49	\$80.56																																																						
50-99	\$76.32																																																						
100+	\$72.93																																																						
PRICE																																																							
1-9	\$195.38																																																						
10-24	\$185.61																																																						
25-49	\$175.84																																																						
50+	\$168.03																																																						
PRICE																																																							
1-9	\$177.22																																																						
10-24	\$168.36																																																						
25-49	\$159.50																																																						
50+	\$152.41																																																						
PRICE																																																							
1-24	\$16.99																																																						
25-49	\$16.14																																																						
50-99	\$15.29																																																						
100+	\$14.61																																																						
PRICE																																																							
1-9	\$205.73																																																						
10-24	\$195.44																																																						
25-49	\$185.16																																																						
50+	\$176.93																																																						
5	 <table border="1"> <thead> <tr> <th colspan="2">PRICE</th> </tr> </thead> <tbody> <tr> <td>1-24</td> <td>\$70.59</td> </tr> <tr> <td>25-49</td> <td>\$67.06</td> </tr> <tr> <td>50-99</td> <td>\$63.53</td> </tr> <tr> <td>100+</td> <td>\$60.71</td> </tr> </tbody> </table> <p>SMA Female to N Male Bulkhead Max. Freq. 11 GHz</p> <p>Model No: <a href="#">PE9551</a></p>	PRICE		1-24	\$70.59	25-49	\$67.06	50-99	\$63.53	100+	\$60.71	 <table border="1"> <thead> <tr> <th colspan="2">PRICE</th> </tr> </thead> <tbody> <tr> <td>1-24</td> <td>\$92.25</td> </tr> <tr> <td>25-49</td> <td>\$87.64</td> </tr> <tr> <td>50-99</td> <td>\$83.03</td> </tr> <tr> <td>100+</td> <td>\$79.34</td> </tr> </tbody> </table> <p>SMA Female to N Male 4 Hole Flange-Mounting Hole A05 VSWR 1.2:1 to 12.4 GHz</p> <p>Model No: <a href="#">PE9275</a></p>	PRICE		1-24	\$92.25	25-49	\$87.64	50-99	\$83.03	100+	\$79.34	 <table border="1"> <thead> <tr> <th colspan="2">PRICE</th> </tr> </thead> <tbody> <tr> <td>1-9</td> <td>\$177.24</td> </tr> <tr> <td>10-24</td> <td>\$168.38</td> </tr> <tr> <td>25-49</td> <td>\$159.52</td> </tr> <tr> <td>50+</td> <td>\$152.43</td> </tr> </tbody> </table> <p>PRECISION SMA Female to N Male 4 Hole Flange-Mounting Hole A05 VSWR 1.15:1 to 18 GHz</p> <p>Model No: <a href="#">PE9498</a></p>	PRICE		1-9	\$177.24	10-24	\$168.38	25-49	\$159.52	50+	\$152.43	 <table border="1"> <thead> <tr> <th colspan="2">PRICE</th> </tr> </thead> <tbody> <tr> <td>1-24</td> <td>\$21.11</td> </tr> <tr> <td>25-49</td> <td>\$20.05</td> </tr> <tr> <td>50-99</td> <td>\$19.00</td> </tr> <tr> <td>100+</td> <td>\$18.15</td> </tr> </tbody> </table> <p>SMA Female to N Female VSWR 1.3:1 to 11 GHz</p> <p>Model No: <a href="#">PE9083</a></p>	PRICE		1-24	\$21.11	25-49	\$20.05	50-99	\$19.00	100+	\$18.15	 <table border="1"> <thead> <tr> <th colspan="2">PRICE</th> </tr> </thead> <tbody> <tr> <td>1-24</td> <td>\$100.81</td> </tr> <tr> <td>25-49</td> <td>\$95.77</td> </tr> <tr> <td>50-99</td> <td>\$90.73</td> </tr> <tr> <td>100+</td> <td>\$86.70</td> </tr> </tbody> </table> <p>PRECISION SMA Female to N Female VSWR 1.15:1 to 18 GHz</p> <p>Model No: <a href="#">PE9432</a></p>	PRICE		1-24	\$100.81	25-49	\$95.77	50-99	\$90.73	100+	\$86.70
	PRICE																																																						
1-24	\$70.59																																																						
25-49	\$67.06																																																						
50-99	\$63.53																																																						
100+	\$60.71																																																						
PRICE																																																							
1-24	\$92.25																																																						
25-49	\$87.64																																																						
50-99	\$83.03																																																						
100+	\$79.34																																																						
PRICE																																																							
1-9	\$177.24																																																						
10-24	\$168.38																																																						
25-49	\$159.52																																																						
50+	\$152.43																																																						
PRICE																																																							
1-24	\$21.11																																																						
25-49	\$20.05																																																						
50-99	\$19.00																																																						
100+	\$18.15																																																						
PRICE																																																							
1-24	\$100.81																																																						
25-49	\$95.77																																																						
50-99	\$90.73																																																						
100+	\$86.70																																																						
6	 <table border="1"> <thead> <tr> <th colspan="2">PRICE</th> </tr> </thead> <tbody> <tr> <td>1-24</td> <td>\$51.00</td> </tr> <tr> <td>25-49</td> <td>\$48.45</td> </tr> <tr> <td>50-99</td> <td>\$45.90</td> </tr> <tr> <td>100+</td> <td>\$43.86</td> </tr> </tbody> </table> <p>SMA Female to N Female Bulkhead VSWR 1.3:1 to 11 GHz</p> <p>Model No: <a href="#">PE9252</a></p>	PRICE		1-24	\$51.00	25-49	\$48.45	50-99	\$45.90	100+	\$43.86	 <table border="1"> <thead> <tr> <th colspan="2">PRICE</th> </tr> </thead> <tbody> <tr> <td>1-9</td> <td>\$157.52</td> </tr> <tr> <td>10-24</td> <td>\$149.64</td> </tr> <tr> <td>25-49</td> <td>\$141.77</td> </tr> <tr> <td>50+</td> <td>\$135.47</td> </tr> </tbody> </table> <p>PRECISION SMA Female to N Female Bulkhead VSWR 1.15:1 to 18 GHz</p> <p>Model No: <a href="#">PE9486</a></p>	PRICE		1-9	\$157.52	10-24	\$149.64	25-49	\$141.77	50+	\$135.47	 <table border="1"> <thead> <tr> <th colspan="2">PRICE</th> </tr> </thead> <tbody> <tr> <td>1-24</td> <td>\$64.37</td> </tr> <tr> <td>25-49</td> <td>\$61.15</td> </tr> <tr> <td>50-99</td> <td>\$57.93</td> </tr> <tr> <td>100+</td> <td>\$55.36</td> </tr> </tbody> </table> <p>SMA Female to N Female 4 Hole Flange-Mounting Hole A05 VSWR 1.3:1 to 11 GHz</p> <p>Model No: <a href="#">PE9104</a></p>	PRICE		1-24	\$64.37	25-49	\$61.15	50-99	\$57.93	100+	\$55.36	 <table border="1"> <thead> <tr> <th colspan="2">PRICE</th> </tr> </thead> <tbody> <tr> <td>1-9</td> <td>\$157.52</td> </tr> <tr> <td>10-24</td> <td>\$149.64</td> </tr> <tr> <td>25-49</td> <td>\$141.77</td> </tr> <tr> <td>50+</td> <td>\$135.47</td> </tr> </tbody> </table> <p>PRECISION SMA Female to N Female 4 Hole Flange-Mounting Hole A05 VSWR 1.15:1 to 18 GHz</p> <p>Model No: <a href="#">PE9434</a></p>	PRICE		1-9	\$157.52	10-24	\$149.64	25-49	\$141.77	50+	\$135.47	 <table border="1"> <thead> <tr> <th colspan="2">PRICE</th> </tr> </thead> <tbody> <tr> <td>1-24</td> <td>\$75.09</td> </tr> <tr> <td>25-49</td> <td>\$71.34</td> </tr> <tr> <td>50-99</td> <td>\$67.58</td> </tr> <tr> <td>100+</td> <td>\$64.58</td> </tr> </tbody> </table> <p>SMA Female to N Female Bulkhead VSWR 1.25:1 to 6 GHz</p> <p>Model No: <a href="#">PE9408</a></p>	PRICE		1-24	\$75.09	25-49	\$71.34	50-99	\$67.58	100+	\$64.58
	PRICE																																																						
1-24	\$51.00																																																						
25-49	\$48.45																																																						
50-99	\$45.90																																																						
100+	\$43.86																																																						
PRICE																																																							
1-9	\$157.52																																																						
10-24	\$149.64																																																						
25-49	\$141.77																																																						
50+	\$135.47																																																						
PRICE																																																							
1-24	\$64.37																																																						
25-49	\$61.15																																																						
50-99	\$57.93																																																						
100+	\$55.36																																																						
PRICE																																																							
1-9	\$157.52																																																						
10-24	\$149.64																																																						
25-49	\$141.77																																																						
50+	\$135.47																																																						
PRICE																																																							
1-24	\$75.09																																																						
25-49	\$71.34																																																						
50-99	\$67.58																																																						
100+	\$64.58																																																						
7	 <table border="1"> <thead> <tr> <th colspan="2">PRICE</th> </tr> </thead> <tbody> <tr> <td>1-9</td> <td>\$161.70</td> </tr> <tr> <td>10-24</td> <td>\$153.62</td> </tr> <tr> <td>25-49</td> <td>\$145.53</td> </tr> <tr> <td>50+</td> <td>\$139.06</td> </tr> </tbody> </table> <p>PRECISION SMA Female to N Female Bulkhead-Mounting Hole G01 VSWR 1.15:1 to 18 GHz</p> <p>Model No: <a href="#">PE9435</a></p>	PRICE		1-9	\$161.70	10-24	\$153.62	25-49	\$145.53	50+	\$139.06	 <table border="1"> <thead> <tr> <th colspan="2">PRICE</th> </tr> </thead> <tbody> <tr> <td>1-24</td> <td>\$63.88</td> </tr> <tr> <td>25-49</td> <td>\$60.69</td> </tr> <tr> <td>50-99</td> <td>\$57.49</td> </tr> <tr> <td>100+</td> <td>\$54.94</td> </tr> </tbody> </table> <p>SMA Female to QMA Male Max. Freq. 18 GHz</p> <p>Model No: <a href="#">PE9786</a></p>	PRICE		1-24	\$63.88	25-49	\$60.69	50-99	\$57.49	100+	\$54.94	 <table border="1"> <thead> <tr> <th colspan="2">PRICE</th> </tr> </thead> <tbody> <tr> <td>1-24</td> <td>\$27.92</td> </tr> <tr> <td>25-49</td> <td>\$26.52</td> </tr> <tr> <td>50-99</td> <td>\$25.13</td> </tr> <tr> <td>100+</td> <td>\$24.01</td> </tr> </tbody> </table> <p>SMA Female to SMB Plug VSWR 1.3:1 to 4 GHz</p> <p>Model No: <a href="#">PE9142</a></p>	PRICE		1-24	\$27.92	25-49	\$26.52	50-99	\$25.13	100+	\$24.01	 <table border="1"> <thead> <tr> <th colspan="2">PRICE</th> </tr> </thead> <tbody> <tr> <td>1-24</td> <td>\$57.95</td> </tr> <tr> <td>25-49</td> <td>\$55.05</td> </tr> <tr> <td>50-99</td> <td>\$52.16</td> </tr> <tr> <td>100+</td> <td>\$49.84</td> </tr> </tbody> </table> <p>SMA Female to SMB Jack VSWR 1.46:1 to 4 GHz</p> <p>Model No: <a href="#">PE9143</a></p>	PRICE		1-24	\$57.95	25-49	\$55.05	50-99	\$52.16	100+	\$49.84	 <table border="1"> <thead> <tr> <th colspan="2">PRICE</th> </tr> </thead> <tbody> <tr> <td>1-24</td> <td>\$56.13</td> </tr> <tr> <td>25-49</td> <td>\$53.32</td> </tr> <tr> <td>50-99</td> <td>\$50.52</td> </tr> <tr> <td>100+</td> <td>\$48.27</td> </tr> </tbody> </table> <p>SMA Female to SMC Plug VSWR 1.2:1 to 10 GHz</p> <p>Model No: <a href="#">PE9146</a></p>	PRICE		1-24	\$56.13	25-49	\$53.32	50-99	\$50.52	100+	\$48.27
	PRICE																																																						
1-9	\$161.70																																																						
10-24	\$153.62																																																						
25-49	\$145.53																																																						
50+	\$139.06																																																						
PRICE																																																							
1-24	\$63.88																																																						
25-49	\$60.69																																																						
50-99	\$57.49																																																						
100+	\$54.94																																																						
PRICE																																																							
1-24	\$27.92																																																						
25-49	\$26.52																																																						
50-99	\$25.13																																																						
100+	\$24.01																																																						
PRICE																																																							
1-24	\$57.95																																																						
25-49	\$55.05																																																						
50-99	\$52.16																																																						
100+	\$49.84																																																						
PRICE																																																							
1-24	\$56.13																																																						
25-49	\$53.32																																																						
50-99	\$50.52																																																						
100+	\$48.27																																																						



# ADAPTERS

See Adapter Locator on Pages 8-13

See Page 369 for Mounting Holes

	A	B	C	D	E																																													
1	 <table border="1"> <thead> <tr><th>PRICE</th></tr> </thead> <tbody> <tr><td>1-24</td><td>\$60.54</td></tr> <tr><td>25-49</td><td>\$57.51</td></tr> <tr><td>50-99</td><td>\$54.49</td></tr> <tr><td>100+</td><td>\$52.06</td></tr> </tbody> </table> <p><b>SMA Female to SMC Jack</b> Max. Freq. 10 GHz Model No: <a href="#">PE9147</a></p>	PRICE	1-24	\$60.54	25-49	\$57.51	50-99	\$54.49	100+	\$52.06	 <table border="1"> <thead> <tr><th>PRICE</th></tr> </thead> <tbody> <tr><td>1-24</td><td>\$71.57</td></tr> <tr><td>25-49</td><td>\$67.99</td></tr> <tr><td>50-99</td><td>\$64.41</td></tr> <tr><td>100+</td><td>\$61.55</td></tr> </tbody> </table> <p><b>SMA Female to Full Detent SMP Male</b> VSWR 1.2:1 to 18 GHz Model No: <a href="#">PE91305</a></p>	PRICE	1-24	\$71.57	25-49	\$67.99	50-99	\$64.41	100+	\$61.55	 <table border="1"> <thead> <tr><th>PRICE</th></tr> </thead> <tbody> <tr><td>1-9</td><td>\$121.91</td></tr> <tr><td>10-24</td><td>\$115.81</td></tr> <tr><td>25-49</td><td>\$109.72</td></tr> <tr><td>50+</td><td>\$104.84</td></tr> </tbody> </table> <p><b>SMA Female to Full Detent SMP Male</b> VSWR 1.2:1 to 26.5 GHz Model No: <a href="#">PE91056</a></p>	PRICE	1-9	\$121.91	10-24	\$115.81	25-49	\$109.72	50+	\$104.84	 <table border="1"> <thead> <tr><th>PRICE</th></tr> </thead> <tbody> <tr><td>1-9</td><td>\$130.19</td></tr> <tr><td>10-24</td><td>\$123.68</td></tr> <tr><td>25-49</td><td>\$117.17</td></tr> <tr><td>50+</td><td>\$111.96</td></tr> </tbody> </table> <p><b>SMA Female to Full Detent SMP Male Bulkhead-Mounting Hole F05</b> VSWR 1.3:1 to 26.5 GHz Model No: <a href="#">PE91054</a></p>	PRICE	1-9	\$130.19	10-24	\$123.68	25-49	\$117.17	50+	\$111.96	 <table border="1"> <thead> <tr><th>PRICE</th></tr> </thead> <tbody> <tr><td>1-9</td><td>\$123.04</td></tr> <tr><td>10-24</td><td>\$116.89</td></tr> <tr><td>25-49</td><td>\$110.74</td></tr> <tr><td>50+</td><td>\$105.81</td></tr> </tbody> </table> <p><b>SMA Female to Full Detent SMP Male 2 Hole Flange-Mounting Hole C01</b> VSWR 1.2:1 to 26.5 GHz Model No: <a href="#">PE91058</a></p>	PRICE	1-9	\$123.04	10-24	\$116.89	25-49	\$110.74	50+	\$105.81
	PRICE																																																	
1-24	\$60.54																																																	
25-49	\$57.51																																																	
50-99	\$54.49																																																	
100+	\$52.06																																																	
PRICE																																																		
1-24	\$71.57																																																	
25-49	\$67.99																																																	
50-99	\$64.41																																																	
100+	\$61.55																																																	
PRICE																																																		
1-9	\$121.91																																																	
10-24	\$115.81																																																	
25-49	\$109.72																																																	
50+	\$104.84																																																	
PRICE																																																		
1-9	\$130.19																																																	
10-24	\$123.68																																																	
25-49	\$117.17																																																	
50+	\$111.96																																																	
PRICE																																																		
1-9	\$123.04																																																	
10-24	\$116.89																																																	
25-49	\$110.74																																																	
50+	\$105.81																																																	
2	 <table border="1"> <thead> <tr><th>PRICE</th></tr> </thead> <tbody> <tr><td>1-24</td><td>\$71.57</td></tr> <tr><td>25-49</td><td>\$67.99</td></tr> <tr><td>50-99</td><td>\$64.41</td></tr> <tr><td>100+</td><td>\$61.55</td></tr> </tbody> </table> <p><b>SMA Female to Limited Detent SMP Male</b> VSWR 1.2:1 to 18 GHz Model No: <a href="#">PE91306</a></p>	PRICE	1-24	\$71.57	25-49	\$67.99	50-99	\$64.41	100+	\$61.55	 <table border="1"> <thead> <tr><th>PRICE</th></tr> </thead> <tbody> <tr><td>1-9</td><td>\$124.77</td></tr> <tr><td>10-24</td><td>\$118.53</td></tr> <tr><td>25-49</td><td>\$112.29</td></tr> <tr><td>50+</td><td>\$107.30</td></tr> </tbody> </table> <p><b>SMA Female to Limited Detent SMP Male</b> VSWR 1.2:1 to 26.5 GHz Model No: <a href="#">PE91050</a></p>	PRICE	1-9	\$124.77	10-24	\$118.53	25-49	\$112.29	50+	\$107.30	 <table border="1"> <thead> <tr><th>PRICE</th></tr> </thead> <tbody> <tr><td>1-9</td><td>\$179.50</td></tr> <tr><td>10-24</td><td>\$170.53</td></tr> <tr><td>25-49</td><td>\$161.55</td></tr> <tr><td>50+</td><td>\$154.37</td></tr> </tbody> </table> <p><b>SMA Female to Limited Detent SMP Male</b> VSWR 1.2:1 to 18 GHz Model No: <a href="#">PE9512</a></p>	PRICE	1-9	\$179.50	10-24	\$170.53	25-49	\$161.55	50+	\$154.37	 <table border="1"> <thead> <tr><th>PRICE</th></tr> </thead> <tbody> <tr><td>1-9</td><td>\$408.56</td></tr> <tr><td>10-24</td><td>\$388.13</td></tr> <tr><td>25-49</td><td>\$367.70</td></tr> <tr><td>50+</td><td>\$351.36</td></tr> </tbody> </table> <p><b>SMA Female to Limited Detent SMP Male</b> Max. Freq. 26.5 GHz Model No: <a href="#">PE9778</a></p>	PRICE	1-9	\$408.56	10-24	\$388.13	25-49	\$367.70	50+	\$351.36	 <table border="1"> <thead> <tr><th>PRICE</th></tr> </thead> <tbody> <tr><td>1-9</td><td>\$135.00</td></tr> <tr><td>10-24</td><td>\$128.25</td></tr> <tr><td>25-49</td><td>\$121.50</td></tr> <tr><td>50+</td><td>\$116.10</td></tr> </tbody> </table> <p><b>SMA Female to Limited Detent SMP Male 2 Hole Flange-Mounting Hole C05</b> VSWR 1.2:1 to 26.5 GHz Model No: <a href="#">PE91066</a></p>	PRICE	1-9	\$135.00	10-24	\$128.25	25-49	\$121.50	50+	\$116.10
	PRICE																																																	
1-24	\$71.57																																																	
25-49	\$67.99																																																	
50-99	\$64.41																																																	
100+	\$61.55																																																	
PRICE																																																		
1-9	\$124.77																																																	
10-24	\$118.53																																																	
25-49	\$112.29																																																	
50+	\$107.30																																																	
PRICE																																																		
1-9	\$179.50																																																	
10-24	\$170.53																																																	
25-49	\$161.55																																																	
50+	\$154.37																																																	
PRICE																																																		
1-9	\$408.56																																																	
10-24	\$388.13																																																	
25-49	\$367.70																																																	
50+	\$351.36																																																	
PRICE																																																		
1-9	\$135.00																																																	
10-24	\$128.25																																																	
25-49	\$121.50																																																	
50+	\$116.10																																																	
3	 <table border="1"> <thead> <tr><th>PRICE</th></tr> </thead> <tbody> <tr><td>1-24</td><td>\$71.57</td></tr> <tr><td>25-49</td><td>\$67.99</td></tr> <tr><td>50-99</td><td>\$64.41</td></tr> <tr><td>100+</td><td>\$61.55</td></tr> </tbody> </table> <p><b>SMA Female to Smooth Bore SMP Male</b> VSWR 1.2:1 to 18 GHz Model No: <a href="#">PE91307</a></p>	PRICE	1-24	\$71.57	25-49	\$67.99	50-99	\$64.41	100+	\$61.55	 <table border="1"> <thead> <tr><th>PRICE</th></tr> </thead> <tbody> <tr><td>1-9</td><td>\$131.83</td></tr> <tr><td>10-24</td><td>\$125.24</td></tr> <tr><td>25-49</td><td>\$118.65</td></tr> <tr><td>50+</td><td>\$113.37</td></tr> </tbody> </table> <p><b>SMA Female to Smooth Bore SMP Male</b> VSWR 1.2:1 to 26.5 GHz Model No: <a href="#">PE91049</a></p>	PRICE	1-9	\$131.83	10-24	\$125.24	25-49	\$118.65	50+	\$113.37	 <table border="1"> <thead> <tr><th>PRICE</th></tr> </thead> <tbody> <tr><td>1-9</td><td>\$121.91</td></tr> <tr><td>10-24</td><td>\$115.81</td></tr> <tr><td>25-49</td><td>\$109.72</td></tr> <tr><td>50+</td><td>\$104.84</td></tr> </tbody> </table> <p><b>SMA Female to Smooth Bore SMP Male 2 Hole Flange-Mounting Hole C05</b> VSWR 1.2:1 to 26.5 GHz Model No: <a href="#">PE91061</a></p>	PRICE	1-9	\$121.91	10-24	\$115.81	25-49	\$109.72	50+	\$104.84	 <table border="1"> <thead> <tr><th>PRICE</th></tr> </thead> <tbody> <tr><td>1-9</td><td>\$124.43</td></tr> <tr><td>10-24</td><td>\$118.21</td></tr> <tr><td>25-49</td><td>\$111.99</td></tr> <tr><td>50+</td><td>\$107.01</td></tr> </tbody> </table> <p><b>SMA Female to SMP Male 2 Hole Flange-Mounting Hole C05</b> VSWR 1.2:1 to 26.5 GHz Model No: <a href="#">PE91057</a></p>	PRICE	1-9	\$124.43	10-24	\$118.21	25-49	\$111.99	50+	\$107.01	 <table border="1"> <thead> <tr><th>PRICE</th></tr> </thead> <tbody> <tr><td>1-9</td><td>\$144.65</td></tr> <tr><td>10-24</td><td>\$137.42</td></tr> <tr><td>25-49</td><td>\$130.19</td></tr> <tr><td>50+</td><td>\$124.40</td></tr> </tbody> </table> <p><b>SMA Female to SMP Male 4 Hole Flange-Mounting Hole A01</b> VSWR 1.2:1 to 26.5 GHz Model No: <a href="#">PE91059</a></p>	PRICE	1-9	\$144.65	10-24	\$137.42	25-49	\$130.19	50+	\$124.40
	PRICE																																																	
1-24	\$71.57																																																	
25-49	\$67.99																																																	
50-99	\$64.41																																																	
100+	\$61.55																																																	
PRICE																																																		
1-9	\$131.83																																																	
10-24	\$125.24																																																	
25-49	\$118.65																																																	
50+	\$113.37																																																	
PRICE																																																		
1-9	\$121.91																																																	
10-24	\$115.81																																																	
25-49	\$109.72																																																	
50+	\$104.84																																																	
PRICE																																																		
1-9	\$124.43																																																	
10-24	\$118.21																																																	
25-49	\$111.99																																																	
50+	\$107.01																																																	
PRICE																																																		
1-9	\$144.65																																																	
10-24	\$137.42																																																	
25-49	\$130.19																																																	
50+	\$124.40																																																	
4	 <table border="1"> <thead> <tr><th>PRICE</th></tr> </thead> <tbody> <tr><td>1-24</td><td>\$70.27</td></tr> <tr><td>25-49</td><td>\$66.76</td></tr> <tr><td>50-99</td><td>\$63.24</td></tr> <tr><td>100+</td><td>\$60.43</td></tr> </tbody> </table> <p><b>SMA Female to SMP Female</b> VSWR 1.2:1 to 18 GHz Model No: <a href="#">PE91308</a></p>	PRICE	1-24	\$70.27	25-49	\$66.76	50-99	\$63.24	100+	\$60.43	 <table border="1"> <thead> <tr><th>PRICE</th></tr> </thead> <tbody> <tr><td>1-9</td><td>\$124.05</td></tr> <tr><td>10-24</td><td>\$117.85</td></tr> <tr><td>25-49</td><td>\$111.65</td></tr> <tr><td>50+</td><td>\$106.68</td></tr> </tbody> </table> <p><b>SMA Female to SMP Female</b> VSWR 1.2:1 to 26.5 GHz Model No: <a href="#">PE91064</a></p>	PRICE	1-9	\$124.05	10-24	\$117.85	25-49	\$111.65	50+	\$106.68	 <table border="1"> <thead> <tr><th>PRICE</th></tr> </thead> <tbody> <tr><td>1-9</td><td>\$220.65</td></tr> <tr><td>10-24</td><td>\$209.62</td></tr> <tr><td>25-49</td><td>\$198.59</td></tr> <tr><td>50+</td><td>\$189.76</td></tr> </tbody> </table> <p><b>SMA Female to SMP Female</b> VSWR 1.2:1 to 18 GHz Model No: <a href="#">PE9779</a></p>	PRICE	1-9	\$220.65	10-24	\$209.62	25-49	\$198.59	50+	\$189.76	 <table border="1"> <thead> <tr><th>PRICE</th></tr> </thead> <tbody> <tr><td>1-24</td><td>\$52.98</td></tr> <tr><td>25-49</td><td>\$50.33</td></tr> <tr><td>50-99</td><td>\$47.68</td></tr> <tr><td>100+</td><td>\$45.56</td></tr> </tbody> </table> <p><b>SMA Female to SSMA Male</b> VSWR 1.3:1 to 18 GHz Model No: <a href="#">PE9188</a></p>	PRICE	1-24	\$52.98	25-49	\$50.33	50-99	\$47.68	100+	\$45.56	 <table border="1"> <thead> <tr><th>PRICE</th></tr> </thead> <tbody> <tr><td>1-24</td><td>\$71.18</td></tr> <tr><td>25-49</td><td>\$67.62</td></tr> <tr><td>50-99</td><td>\$64.06</td></tr> <tr><td>100+</td><td>\$61.21</td></tr> </tbody> </table> <p><b>SMA Female to SSMA Female</b> VSWR 1.4:1 to 18 GHz Model No: <a href="#">PE9399</a></p>	PRICE	1-24	\$71.18	25-49	\$67.62	50-99	\$64.06	100+	\$61.21
	PRICE																																																	
1-24	\$70.27																																																	
25-49	\$66.76																																																	
50-99	\$63.24																																																	
100+	\$60.43																																																	
PRICE																																																		
1-9	\$124.05																																																	
10-24	\$117.85																																																	
25-49	\$111.65																																																	
50+	\$106.68																																																	
PRICE																																																		
1-9	\$220.65																																																	
10-24	\$209.62																																																	
25-49	\$198.59																																																	
50+	\$189.76																																																	
PRICE																																																		
1-24	\$52.98																																																	
25-49	\$50.33																																																	
50-99	\$47.68																																																	
100+	\$45.56																																																	
PRICE																																																		
1-24	\$71.18																																																	
25-49	\$67.62																																																	
50-99	\$64.06																																																	
100+	\$61.21																																																	
5	 <table border="1"> <thead> <tr><th>PRICE</th></tr> </thead> <tbody> <tr><td>1-24</td><td>\$62.97</td></tr> <tr><td>25-49</td><td>\$59.82</td></tr> <tr><td>50-99</td><td>\$56.67</td></tr> <tr><td>100+</td><td>\$54.15</td></tr> </tbody> </table> <p><b>SMA Female to SSMB Plug</b> Model No: <a href="#">PE9402</a></p>	PRICE	1-24	\$62.97	25-49	\$59.82	50-99	\$56.67	100+	\$54.15	 <table border="1"> <thead> <tr><th>PRICE</th></tr> </thead> <tbody> <tr><td>1-24</td><td>\$57.92</td></tr> <tr><td>25-49</td><td>\$55.02</td></tr> <tr><td>50-99</td><td>\$52.13</td></tr> <tr><td>100+</td><td>\$49.81</td></tr> </tbody> </table> <p><b>SMA Female to SSMC Plug</b> VSWR 1.25:1 to 3 GHz Model No: <a href="#">PE91380</a></p>	PRICE	1-24	\$57.92	25-49	\$55.02	50-99	\$52.13	100+	\$49.81	 <table border="1"> <thead> <tr><th>PRICE</th></tr> </thead> <tbody> <tr><td>1-24</td><td>\$59.34</td></tr> <tr><td>25-49</td><td>\$56.37</td></tr> <tr><td>50-99</td><td>\$53.41</td></tr> <tr><td>100+</td><td>\$51.03</td></tr> </tbody> </table> <p><b>SMA Female to SSMC Jack</b> VSWR 1.25:1 to 3 GHz Model No: <a href="#">PE91433</a></p>	PRICE	1-24	\$59.34	25-49	\$56.37	50-99	\$53.41	100+	\$51.03	 <table border="1"> <thead> <tr><th>PRICE</th></tr> </thead> <tbody> <tr><td>1-24</td><td>\$20.02</td></tr> <tr><td>25-49</td><td>\$19.02</td></tr> <tr><td>50-99</td><td>\$18.02</td></tr> <tr><td>100+</td><td>\$17.22</td></tr> </tbody> </table> <p><b>SMA Female to TNC Male</b> VSWR 1.3:1 to 11 GHz Model No: <a href="#">PE9077</a></p>	PRICE	1-24	\$20.02	25-49	\$19.02	50-99	\$18.02	100+	\$17.22	 <table border="1"> <thead> <tr><th>PRICE</th></tr> </thead> <tbody> <tr><td>1-9</td><td>\$116.95</td></tr> <tr><td>10-24</td><td>\$111.10</td></tr> <tr><td>25-49</td><td>\$105.26</td></tr> <tr><td>50+</td><td>\$100.58</td></tr> </tbody> </table> <p><b>SMA Female to TNC Male</b> VSWR 1.25:1 to 18 GHz Model No: <a href="#">PE9440</a></p>	PRICE	1-9	\$116.95	10-24	\$111.10	25-49	\$105.26	50+	\$100.58
	PRICE																																																	
1-24	\$62.97																																																	
25-49	\$59.82																																																	
50-99	\$56.67																																																	
100+	\$54.15																																																	
PRICE																																																		
1-24	\$57.92																																																	
25-49	\$55.02																																																	
50-99	\$52.13																																																	
100+	\$49.81																																																	
PRICE																																																		
1-24	\$59.34																																																	
25-49	\$56.37																																																	
50-99	\$53.41																																																	
100+	\$51.03																																																	
PRICE																																																		
1-24	\$20.02																																																	
25-49	\$19.02																																																	
50-99	\$18.02																																																	
100+	\$17.22																																																	
PRICE																																																		
1-9	\$116.95																																																	
10-24	\$111.10																																																	
25-49	\$105.26																																																	
50+	\$100.58																																																	
6	 <table border="1"> <thead> <tr><th>PRICE</th></tr> </thead> <tbody> <tr><td>1-24</td><td>\$47.98</td></tr> <tr><td>25-49</td><td>\$45.58</td></tr> <tr><td>50-99</td><td>\$43.18</td></tr> <tr><td>100+</td><td>\$41.26</td></tr> </tbody> </table> <p><b>SMA Female to TNC Female</b> Max. Freq. 11 GHz Model No: <a href="#">PE9079</a></p>	PRICE	1-24	\$47.98	25-49	\$45.58	50-99	\$43.18	100+	\$41.26	 <table border="1"> <thead> <tr><th>PRICE</th></tr> </thead> <tbody> <tr><td>1-9</td><td>\$141.75</td></tr> <tr><td>10-24</td><td>\$134.66</td></tr> <tr><td>25-49</td><td>\$127.58</td></tr> <tr><td>50+</td><td>\$121.91</td></tr> </tbody> </table> <p><b>SMA Female to TNC Female</b> VSWR 1.25:1 to 18 GHz Model No: <a href="#">PE9442</a></p>	PRICE	1-9	\$141.75	10-24	\$134.66	25-49	\$127.58	50+	\$121.91	 <table border="1"> <thead> <tr><th>PRICE</th></tr> </thead> <tbody> <tr><td>1-24</td><td>\$50.78</td></tr> <tr><td>25-49</td><td>\$48.24</td></tr> <tr><td>50-99</td><td>\$45.70</td></tr> <tr><td>100+</td><td>\$43.67</td></tr> </tbody> </table> <p><b>SMA Female to TNC Female Bulkhead</b> VSWR 1.3:1 to 11 GHz Model No: <a href="#">PE9251</a></p>	PRICE	1-24	\$50.78	25-49	\$48.24	50-99	\$45.70	100+	\$43.67	 <table border="1"> <thead> <tr><th>PRICE</th></tr> </thead> <tbody> <tr><td>1-24</td><td>\$53.03</td></tr> <tr><td>25-49</td><td>\$50.38</td></tr> <tr><td>50-99</td><td>\$47.73</td></tr> <tr><td>100+</td><td>\$45.61</td></tr> </tbody> </table> <p><b>SMA Female to TNC Female 4 Hole Flange-Mounting Hole A03</b> Model No: <a href="#">PE9276</a></p>	PRICE	1-24	\$53.03	25-49	\$50.38	50-99	\$47.73	100+	\$45.61	 <table border="1"> <thead> <tr><th>PRICE</th></tr> </thead> <tbody> <tr><td>1-24</td><td>\$58.50</td></tr> <tr><td>25-49</td><td>\$55.58</td></tr> <tr><td>50-99</td><td>\$52.65</td></tr> <tr><td>100+</td><td>\$50.31</td></tr> </tbody> </table> <p><b>SMA Female to UHF Male</b> VSWR 1.3:1 to 300 MHz Model No: <a href="#">PE9415</a></p>	PRICE	1-24	\$58.50	25-49	\$55.58	50-99	\$52.65	100+	\$50.31
	PRICE																																																	
1-24	\$47.98																																																	
25-49	\$45.58																																																	
50-99	\$43.18																																																	
100+	\$41.26																																																	
PRICE																																																		
1-9	\$141.75																																																	
10-24	\$134.66																																																	
25-49	\$127.58																																																	
50+	\$121.91																																																	
PRICE																																																		
1-24	\$50.78																																																	
25-49	\$48.24																																																	
50-99	\$45.70																																																	
100+	\$43.67																																																	
PRICE																																																		
1-24	\$53.03																																																	
25-49	\$50.38																																																	
50-99	\$47.73																																																	
100+	\$45.61																																																	
PRICE																																																		
1-24	\$58.50																																																	
25-49	\$55.58																																																	
50-99	\$52.65																																																	
100+	\$50.31																																																	
7	 <table border="1"> <thead> <tr><th>PRICE</th></tr> </thead> <tbody> <tr><td>1-24</td><td>\$24.07</td></tr> <tr><td>25-49</td><td>\$22.87</td></tr> <tr><td>50-99</td><td>\$21.66</td></tr> <tr><td>100+</td><td>\$20.70</td></tr> </tbody> </table> <p><b>SMA Female to UMCX Plug</b> VSWR 1.3:1 to 6 GHz Model No: <a href="#">PE91005</a></p>	PRICE	1-24	\$24.07	25-49	\$22.87	50-99	\$21.66	100+	\$20.70	 <table border="1"> <thead> <tr><th>PRICE</th></tr> </thead> <tbody> <tr><td>1-24</td><td>\$29.85</td></tr> <tr><td>25-49</td><td>\$28.36</td></tr> <tr><td>50-99</td><td>\$26.87</td></tr> <tr><td>100+</td><td>\$25.67</td></tr> </tbody> </table> <p><b>SMA Female to UMCX Jack</b> VSWR 1.3:1 to 6 GHz Model No: <a href="#">PE91006</a></p>	PRICE	1-24	\$29.85	25-49	\$28.36	50-99	\$26.87	100+	\$25.67	<p><b>Reverse Polarity SMA Between Series</b></p> <p>→</p>		 <table border="1"> <thead> <tr><th>PRICE</th></tr> </thead> <tbody> <tr><td>1-24</td><td>\$82.08</td></tr> <tr><td>25-49</td><td>\$77.98</td></tr> <tr><td>50-99</td><td>\$73.87</td></tr> <tr><td>100+</td><td>\$70.59</td></tr> </tbody> </table> <p><b>SMA Male to Rev. Pol. MCX Plug</b> VSWR 1.2:1 to 6 GHz Model No: <a href="#">PE9581</a></p>	PRICE	1-24	\$82.08	25-49	\$77.98	50-99	\$73.87	100+	\$70.59	 <table border="1"> <thead> <tr><th>PRICE</th></tr> </thead> <tbody> <tr><td>1-24</td><td>\$59.26</td></tr> <tr><td>25-49</td><td>\$56.30</td></tr> <tr><td>50-99</td><td>\$53.33</td></tr> <tr><td>100+</td><td>\$50.96</td></tr> </tbody> </table> <p><b>SMA Male to Rev. Pol. TNC Female</b> VSWR 1.25:1 to 11 GHz Model No: <a href="#">PE9600</a></p>	PRICE	1-24	\$59.26	25-49	\$56.30	50-99	\$53.33	100+	\$50.96								
	PRICE																																																	
1-24	\$24.07																																																	
25-49	\$22.87																																																	
50-99	\$21.66																																																	
100+	\$20.70																																																	
PRICE																																																		
1-24	\$29.85																																																	
25-49	\$28.36																																																	
50-99	\$26.87																																																	
100+	\$25.67																																																	
PRICE																																																		
1-24	\$82.08																																																	
25-49	\$77.98																																																	
50-99	\$73.87																																																	
100+	\$70.59																																																	
PRICE																																																		
1-24	\$59.26																																																	
25-49	\$56.30																																																	
50-99	\$53.33																																																	
100+	\$50.96																																																	

# ADAPTERS

See Adapter Locator on Pages 8-13

See Page 369 for Mounting Holes

Adapters

See Our Website For Current Pricing & Real-Time Stock Availability!

	A	B	C	D	E																																																		
1	 <table border="1"> <thead> <tr> <th colspan="2">PRICE</th> </tr> </thead> <tbody> <tr> <td>1-24</td> <td>\$56.97</td> </tr> <tr> <td>25-49</td> <td>\$54.12</td> </tr> <tr> <td>50-99</td> <td>\$51.27</td> </tr> <tr> <td>100+</td> <td>\$48.99</td> </tr> </tbody> </table> <p>SMA Female to Rev. Pol. TNC Male Max. Freq. 11 GHz Model No: <a href="#">PE9602</a></p>	PRICE		1-24	\$56.97	25-49	\$54.12	50-99	\$51.27	100+	\$48.99	 <table border="1"> <thead> <tr> <th colspan="2">PRICE</th> </tr> </thead> <tbody> <tr> <td>1-24</td> <td>\$74.24</td> </tr> <tr> <td>25-49</td> <td>\$70.53</td> </tr> <tr> <td>50-99</td> <td>\$66.82</td> </tr> <tr> <td>100+</td> <td>\$63.85</td> </tr> </tbody> </table> <p>SMA Female to Rev. Pol. TNC Female VSWR 1.25:1 to 11 GHz Model No: <a href="#">PE9603</a></p>	PRICE		1-24	\$74.24	25-49	\$70.53	50-99	\$66.82	100+	\$63.85	 <table border="1"> <thead> <tr> <th colspan="2">PRICE</th> </tr> </thead> <tbody> <tr> <td>1-24</td> <td>\$77.28</td> </tr> <tr> <td>25-49</td> <td>\$73.42</td> </tr> <tr> <td>50-99</td> <td>\$69.55</td> </tr> <tr> <td>100+</td> <td>\$66.46</td> </tr> </tbody> </table> <p>Rev. Pol. SMA Male to N Female VSWR 1.25:1 to 11 GHz Model No: <a href="#">PE9732</a></p>	PRICE		1-24	\$77.28	25-49	\$73.42	50-99	\$69.55	100+	\$66.46	 <table border="1"> <thead> <tr> <th colspan="2">PRICE</th> </tr> </thead> <tbody> <tr> <td>1-24</td> <td>\$65.30</td> </tr> <tr> <td>25-49</td> <td>\$62.04</td> </tr> <tr> <td>50-99</td> <td>\$58.77</td> </tr> <tr> <td>100+</td> <td>\$56.16</td> </tr> </tbody> </table> <p>Rev. Pol. SMA Male to TNC Male VSWR 1.2:1 to 11 GHz Model No: <a href="#">PE9597</a></p>	PRICE		1-24	\$65.30	25-49	\$62.04	50-99	\$58.77	100+	\$56.16	 <table border="1"> <thead> <tr> <th colspan="2">PRICE</th> </tr> </thead> <tbody> <tr> <td>1-24</td> <td>\$62.87</td> </tr> <tr> <td>25-49</td> <td>\$59.73</td> </tr> <tr> <td>50-99</td> <td>\$56.58</td> </tr> <tr> <td>100+</td> <td>\$54.07</td> </tr> </tbody> </table> <p>Rev. Pol. SMA Male to TNC Female VSWR 1.2:1 to 11 GHz Model No: <a href="#">PE9596</a></p>	PRICE		1-24	\$62.87	25-49	\$59.73	50-99	\$56.58	100+	\$54.07
PRICE																																																							
1-24	\$56.97																																																						
25-49	\$54.12																																																						
50-99	\$51.27																																																						
100+	\$48.99																																																						
PRICE																																																							
1-24	\$74.24																																																						
25-49	\$70.53																																																						
50-99	\$66.82																																																						
100+	\$63.85																																																						
PRICE																																																							
1-24	\$77.28																																																						
25-49	\$73.42																																																						
50-99	\$69.55																																																						
100+	\$66.46																																																						
PRICE																																																							
1-24	\$65.30																																																						
25-49	\$62.04																																																						
50-99	\$58.77																																																						
100+	\$56.16																																																						
PRICE																																																							
1-24	\$62.87																																																						
25-49	\$59.73																																																						
50-99	\$56.58																																																						
100+	\$54.07																																																						
2	 <table border="1"> <thead> <tr> <th colspan="2">PRICE</th> </tr> </thead> <tbody> <tr> <td>1-24</td> <td>\$84.23</td> </tr> <tr> <td>25-49</td> <td>\$80.02</td> </tr> <tr> <td>50-99</td> <td>\$75.81</td> </tr> <tr> <td>100+</td> <td>\$72.44</td> </tr> </tbody> </table> <p>Rev. Pol. SMA Female to N Male VSWR 1.25:1 to 11 GHz Model No: <a href="#">PE9733</a></p>	PRICE		1-24	\$84.23	25-49	\$80.02	50-99	\$75.81	100+	\$72.44	 <table border="1"> <thead> <tr> <th colspan="2">PRICE</th> </tr> </thead> <tbody> <tr> <td>1-24</td> <td>\$64.03</td> </tr> <tr> <td>25-49</td> <td>\$60.83</td> </tr> <tr> <td>50-99</td> <td>\$57.63</td> </tr> <tr> <td>100+</td> <td>\$55.07</td> </tr> </tbody> </table> <p>Rev. Pol. SMA Female to TNC Male VSWR 1.2:1 to 11 GHz Model No: <a href="#">PE9598</a></p>	PRICE		1-24	\$64.03	25-49	\$60.83	50-99	\$57.63	100+	\$55.07	 <table border="1"> <thead> <tr> <th colspan="2">PRICE</th> </tr> </thead> <tbody> <tr> <td>1-24</td> <td>\$65.30</td> </tr> <tr> <td>25-49</td> <td>\$62.04</td> </tr> <tr> <td>50-99</td> <td>\$58.77</td> </tr> <tr> <td>100+</td> <td>\$56.16</td> </tr> </tbody> </table> <p>Rev. Pol. SMA Female to TNC Female VSWR 1.2:1 to 11 GHz Model No: <a href="#">PE9599</a></p>	PRICE		1-24	\$65.30	25-49	\$62.04	50-99	\$58.77	100+	\$56.16	 <table border="1"> <thead> <tr> <th colspan="2">PRICE</th> </tr> </thead> <tbody> <tr> <td>1-24</td> <td>\$65.30</td> </tr> <tr> <td>25-49</td> <td>\$62.04</td> </tr> <tr> <td>50-99</td> <td>\$58.77</td> </tr> <tr> <td>100+</td> <td>\$56.16</td> </tr> </tbody> </table> <p>Rev. Pol. SMA Male to Rev. Pol. TNC Male VSWR 1.2:1 to 11 GHz Model No: <a href="#">PE9605</a></p>	PRICE		1-24	\$65.30	25-49	\$62.04	50-99	\$58.77	100+	\$56.16	 <table border="1"> <thead> <tr> <th colspan="2">PRICE</th> </tr> </thead> <tbody> <tr> <td>1-24</td> <td>\$83.50</td> </tr> <tr> <td>25-49</td> <td>\$79.33</td> </tr> <tr> <td>50-99</td> <td>\$75.15</td> </tr> <tr> <td>100+</td> <td>\$71.81</td> </tr> </tbody> </table> <p>Rev. Pol. SMA Male to Rev. Pol. TNC Female VSWR 1.25:1 to 11 GHz Model No: <a href="#">PE9604</a></p>	PRICE		1-24	\$83.50	25-49	\$79.33	50-99	\$75.15	100+	\$71.81
PRICE																																																							
1-24	\$84.23																																																						
25-49	\$80.02																																																						
50-99	\$75.81																																																						
100+	\$72.44																																																						
PRICE																																																							
1-24	\$64.03																																																						
25-49	\$60.83																																																						
50-99	\$57.63																																																						
100+	\$55.07																																																						
PRICE																																																							
1-24	\$65.30																																																						
25-49	\$62.04																																																						
50-99	\$58.77																																																						
100+	\$56.16																																																						
PRICE																																																							
1-24	\$65.30																																																						
25-49	\$62.04																																																						
50-99	\$58.77																																																						
100+	\$56.16																																																						
PRICE																																																							
1-24	\$83.50																																																						
25-49	\$79.33																																																						
50-99	\$75.15																																																						
100+	\$71.81																																																						
3	 <table border="1"> <thead> <tr> <th colspan="2">PRICE</th> </tr> </thead> <tbody> <tr> <td>1-24</td> <td>\$65.30</td> </tr> <tr> <td>25-49</td> <td>\$62.04</td> </tr> <tr> <td>50-99</td> <td>\$58.77</td> </tr> <tr> <td>100+</td> <td>\$56.16</td> </tr> </tbody> </table> <p>Rev. Pol. SMA Female to Rev. Pol. TNC Male VSWR 1.2:1 to 11 GHz Model No: <a href="#">PE9607</a></p>	PRICE		1-24	\$65.30	25-49	\$62.04	50-99	\$58.77	100+	\$56.16	 <table border="1"> <thead> <tr> <th colspan="2">PRICE</th> </tr> </thead> <tbody> <tr> <td>1-24</td> <td>\$65.30</td> </tr> <tr> <td>25-49</td> <td>\$62.04</td> </tr> <tr> <td>50-99</td> <td>\$58.77</td> </tr> <tr> <td>100+</td> <td>\$56.16</td> </tr> </tbody> </table> <p>Rev. Pol. SMA Female to Rev. Pol. TNC Female VSWR 1.25:1 to 11 GHz Model No: <a href="#">PE9606</a></p>	PRICE		1-24	\$65.30	25-49	\$62.04	50-99	\$58.77	100+	\$56.16	<p><b>SMB In-Series</b></p> 		 <table border="1"> <thead> <tr> <th colspan="2">PRICE</th> </tr> </thead> <tbody> <tr> <td>1-24</td> <td>\$36.17</td> </tr> <tr> <td>25-49</td> <td>\$34.36</td> </tr> <tr> <td>50-99</td> <td>\$32.55</td> </tr> <tr> <td>100+</td> <td>\$31.11</td> </tr> </tbody> </table> <p>SMB Plug to SMB Plug Max. Freq. 4 GHz Model No: <a href="#">PE9118</a></p>	PRICE		1-24	\$36.17	25-49	\$34.36	50-99	\$32.55	100+	\$31.11	 <table border="1"> <thead> <tr> <th colspan="2">PRICE</th> </tr> </thead> <tbody> <tr> <td>1-24</td> <td>\$93.26</td> </tr> <tr> <td>25-49</td> <td>\$88.60</td> </tr> <tr> <td>50-99</td> <td>\$83.93</td> </tr> <tr> <td>100+</td> <td>\$80.20</td> </tr> </tbody> </table> <p>SMB Plug to SMB Plug Tee Max. Freq. 4 GHz Model No: <a href="#">PE9310</a></p>	PRICE		1-24	\$93.26	25-49	\$88.60	50-99	\$83.93	100+	\$80.20									
PRICE																																																							
1-24	\$65.30																																																						
25-49	\$62.04																																																						
50-99	\$58.77																																																						
100+	\$56.16																																																						
PRICE																																																							
1-24	\$65.30																																																						
25-49	\$62.04																																																						
50-99	\$58.77																																																						
100+	\$56.16																																																						
PRICE																																																							
1-24	\$36.17																																																						
25-49	\$34.36																																																						
50-99	\$32.55																																																						
100+	\$31.11																																																						
PRICE																																																							
1-24	\$93.26																																																						
25-49	\$88.60																																																						
50-99	\$83.93																																																						
100+	\$80.20																																																						
4	 <table border="1"> <thead> <tr> <th colspan="2">PRICE</th> </tr> </thead> <tbody> <tr> <td>1-24</td> <td>\$62.86</td> </tr> <tr> <td>25-49</td> <td>\$59.72</td> </tr> <tr> <td>50-99</td> <td>\$56.57</td> </tr> <tr> <td>100+</td> <td>\$54.06</td> </tr> </tbody> </table> <p>SMB Plug to SMB Jack VSWR 1.2:1 to 4 GHz Model No: <a href="#">PE9120</a></p>	PRICE		1-24	\$62.86	25-49	\$59.72	50-99	\$56.57	100+	\$54.06	 <table border="1"> <thead> <tr> <th colspan="2">PRICE</th> </tr> </thead> <tbody> <tr> <td>1-24</td> <td>\$70.80</td> </tr> <tr> <td>25-49</td> <td>\$67.26</td> </tr> <tr> <td>50-99</td> <td>\$63.72</td> </tr> <tr> <td>100+</td> <td>\$60.89</td> </tr> </tbody> </table> <p>SMB Plug to SMB Jack Tee Model No: <a href="#">PE9309</a></p>	PRICE		1-24	\$70.80	25-49	\$67.26	50-99	\$63.72	100+	\$60.89	 <table border="1"> <thead> <tr> <th colspan="2">PRICE</th> </tr> </thead> <tbody> <tr> <td>1-24</td> <td>\$41.48</td> </tr> <tr> <td>25-49</td> <td>\$39.41</td> </tr> <tr> <td>50-99</td> <td>\$37.33</td> </tr> <tr> <td>100+</td> <td>\$35.67</td> </tr> </tbody> </table> <p>SMB Jack to SMB Plug Tee Max. Freq. 100 MHz Model No: <a href="#">PE9243</a></p>	PRICE		1-24	\$41.48	25-49	\$39.41	50-99	\$37.33	100+	\$35.67	 <table border="1"> <thead> <tr> <th colspan="2">PRICE</th> </tr> </thead> <tbody> <tr> <td>1-24</td> <td>\$50.65</td> </tr> <tr> <td>25-49</td> <td>\$48.12</td> </tr> <tr> <td>50-99</td> <td>\$45.59</td> </tr> <tr> <td>100+</td> <td>\$43.56</td> </tr> </tbody> </table> <p>SMB Jack to SMB Jack VSWR 1.3:1 to 4 GHz Model No: <a href="#">PE9116</a></p>	PRICE		1-24	\$50.65	25-49	\$48.12	50-99	\$45.59	100+	\$43.56	 <table border="1"> <thead> <tr> <th colspan="2">PRICE</th> </tr> </thead> <tbody> <tr> <td>1-24</td> <td>\$50.13</td> </tr> <tr> <td>25-49</td> <td>\$47.62</td> </tr> <tr> <td>50-99</td> <td>\$45.12</td> </tr> <tr> <td>100+</td> <td>\$43.11</td> </tr> </tbody> </table> <p>SMB Jack to SMB Jack Tee Model No: <a href="#">PE9302</a></p>	PRICE		1-24	\$50.13	25-49	\$47.62	50-99	\$45.12	100+	\$43.11
PRICE																																																							
1-24	\$62.86																																																						
25-49	\$59.72																																																						
50-99	\$56.57																																																						
100+	\$54.06																																																						
PRICE																																																							
1-24	\$70.80																																																						
25-49	\$67.26																																																						
50-99	\$63.72																																																						
100+	\$60.89																																																						
PRICE																																																							
1-24	\$41.48																																																						
25-49	\$39.41																																																						
50-99	\$37.33																																																						
100+	\$35.67																																																						
PRICE																																																							
1-24	\$50.65																																																						
25-49	\$48.12																																																						
50-99	\$45.59																																																						
100+	\$43.56																																																						
PRICE																																																							
1-24	\$50.13																																																						
25-49	\$47.62																																																						
50-99	\$45.12																																																						
100+	\$43.11																																																						
5	 <table border="1"> <thead> <tr> <th colspan="2">PRICE</th> </tr> </thead> <tbody> <tr> <td>1-24</td> <td>\$34.77</td> </tr> <tr> <td>25-49</td> <td>\$33.03</td> </tr> <tr> <td>50-99</td> <td>\$31.29</td> </tr> <tr> <td>100+</td> <td>\$29.90</td> </tr> </tbody> </table> <p>SMB Jack to SMB Jack Bulkhead-Mounting Hole B01 Max. Freq. 4 GHz Model No: <a href="#">PE9122</a></p>	PRICE		1-24	\$34.77	25-49	\$33.03	50-99	\$31.29	100+	\$29.90	<p><b>SMB Between Series</b></p> 		 <table border="1"> <thead> <tr> <th colspan="2">PRICE</th> </tr> </thead> <tbody> <tr> <td>1-24</td> <td>\$56.29</td> </tr> <tr> <td>25-49</td> <td>\$53.48</td> </tr> <tr> <td>50-99</td> <td>\$50.66</td> </tr> <tr> <td>100+</td> <td>\$48.41</td> </tr> </tbody> </table> <p>SMB Plug to BNC Male Max. Freq. 4 GHz Model No: <a href="#">PE9135</a></p>	PRICE		1-24	\$56.29	25-49	\$53.48	50-99	\$50.66	100+	\$48.41	 <table border="1"> <thead> <tr> <th colspan="2">PRICE</th> </tr> </thead> <tbody> <tr> <td>1-24</td> <td>\$59.31</td> </tr> <tr> <td>25-49</td> <td>\$56.34</td> </tr> <tr> <td>50-99</td> <td>\$53.38</td> </tr> <tr> <td>100+</td> <td>\$51.01</td> </tr> </tbody> </table> <p>SMB Plug to BNC Female VSWR 1.3:1 to 4 GHz Model No: <a href="#">PE9137</a></p>	PRICE		1-24	\$59.31	25-49	\$56.34	50-99	\$53.38	100+	\$51.01	 <table border="1"> <thead> <tr> <th colspan="2">PRICE</th> </tr> </thead> <tbody> <tr> <td>1-24</td> <td>\$49.94</td> </tr> <tr> <td>25-49</td> <td>\$47.44</td> </tr> <tr> <td>50-99</td> <td>\$44.95</td> </tr> <tr> <td>100+</td> <td>\$42.95</td> </tr> </tbody> </table> <p>SMB Plug to BNC Female Bulkhead-Mounting Hole B05 Max. Freq. 3 GHz Model No: <a href="#">PE9241</a></p>	PRICE		1-24	\$49.94	25-49	\$47.44	50-99	\$44.95	100+	\$42.95									
PRICE																																																							
1-24	\$34.77																																																						
25-49	\$33.03																																																						
50-99	\$31.29																																																						
100+	\$29.90																																																						
PRICE																																																							
1-24	\$56.29																																																						
25-49	\$53.48																																																						
50-99	\$50.66																																																						
100+	\$48.41																																																						
PRICE																																																							
1-24	\$59.31																																																						
25-49	\$56.34																																																						
50-99	\$53.38																																																						
100+	\$51.01																																																						
PRICE																																																							
1-24	\$49.94																																																						
25-49	\$47.44																																																						
50-99	\$44.95																																																						
100+	\$42.95																																																						
6	 <table border="1"> <thead> <tr> <th colspan="2">PRICE</th> </tr> </thead> <tbody> <tr> <td>1-24</td> <td>\$56.28</td> </tr> <tr> <td>25-49</td> <td>\$53.47</td> </tr> <tr> <td>50-99</td> <td>\$50.65</td> </tr> <tr> <td>100+</td> <td>\$48.40</td> </tr> </tbody> </table> <p>SMB Jack to BNC Male Max. Freq. 4 GHz Model No: <a href="#">PE9132</a></p>	PRICE		1-24	\$56.28	25-49	\$53.47	50-99	\$50.65	100+	\$48.40	 <table border="1"> <thead> <tr> <th colspan="2">PRICE</th> </tr> </thead> <tbody> <tr> <td>1-24</td> <td>\$58.25</td> </tr> <tr> <td>25-49</td> <td>\$55.34</td> </tr> <tr> <td>50-99</td> <td>\$52.43</td> </tr> <tr> <td>100+</td> <td>\$50.10</td> </tr> </tbody> </table> <p>SMB Jack to BNC Female Max. Freq. 4 GHz Model No: <a href="#">PE9136</a></p>	PRICE		1-24	\$58.25	25-49	\$55.34	50-99	\$52.43	100+	\$50.10	 <table border="1"> <thead> <tr> <th colspan="2">PRICE</th> </tr> </thead> <tbody> <tr> <td>1-24</td> <td>\$53.02</td> </tr> <tr> <td>25-49</td> <td>\$50.37</td> </tr> <tr> <td>50-99</td> <td>\$47.72</td> </tr> <tr> <td>100+</td> <td>\$45.60</td> </tr> </tbody> </table> <p>SMB Jack to BNC Female Bulkhead VSWR 1.3:1 to 4 GHz Model No: <a href="#">PE9240</a></p>	PRICE		1-24	\$53.02	25-49	\$50.37	50-99	\$47.72	100+	\$45.60	<p><b>SMC In-Series</b></p> 		 <table border="1"> <thead> <tr> <th colspan="2">PRICE</th> </tr> </thead> <tbody> <tr> <td>1-24</td> <td>\$32.63</td> </tr> <tr> <td>25-49</td> <td>\$31.00</td> </tr> <tr> <td>50-99</td> <td>\$29.37</td> </tr> <tr> <td>100+</td> <td>\$28.06</td> </tr> </tbody> </table> <p>SMC Plug to SMC Plug Max. Freq. 6 GHz Model No: <a href="#">PE9117</a></p>	PRICE		1-24	\$32.63	25-49	\$31.00	50-99	\$29.37	100+	\$28.06									
PRICE																																																							
1-24	\$56.28																																																						
25-49	\$53.47																																																						
50-99	\$50.65																																																						
100+	\$48.40																																																						
PRICE																																																							
1-24	\$58.25																																																						
25-49	\$55.34																																																						
50-99	\$52.43																																																						
100+	\$50.10																																																						
PRICE																																																							
1-24	\$53.02																																																						
25-49	\$50.37																																																						
50-99	\$47.72																																																						
100+	\$45.60																																																						
PRICE																																																							
1-24	\$32.63																																																						
25-49	\$31.00																																																						
50-99	\$29.37																																																						
100+	\$28.06																																																						
7	 <table border="1"> <thead> <tr> <th colspan="2">PRICE</th> </tr> </thead> <tbody> <tr> <td>1-24</td> <td>\$56.51</td> </tr> <tr> <td>25-49</td> <td>\$53.68</td> </tr> <tr> <td>50-99</td> <td>\$50.86</td> </tr> <tr> <td>100+</td> <td>\$48.60</td> </tr> </tbody> </table> <p>SMC Plug to SMC Plug Tee Model No: <a href="#">PE9305</a></p>	PRICE		1-24	\$56.51	25-49	\$53.68	50-99	\$50.86	100+	\$48.60	 <table border="1"> <thead> <tr> <th colspan="2">PRICE</th> </tr> </thead> <tbody> <tr> <td>1-24</td> <td>\$48.44</td> </tr> <tr> <td>25-49</td> <td>\$46.02</td> </tr> <tr> <td>50-99</td> <td>\$43.60</td> </tr> <tr> <td>100+</td> <td>\$41.66</td> </tr> </tbody> </table> <p>SMC Plug to SMC Jack VSWR 1.2:1 to 10 GHz Model No: <a href="#">PE9119</a></p>	PRICE		1-24	\$48.44	25-49	\$46.02	50-99	\$43.60	100+	\$41.66	 <table border="1"> <thead> <tr> <th colspan="2">PRICE</th> </tr> </thead> <tbody> <tr> <td>1-24</td> <td>\$62.15</td> </tr> <tr> <td>25-49</td> <td>\$59.04</td> </tr> <tr> <td>50-99</td> <td>\$55.94</td> </tr> <tr> <td>100+</td> <td>\$53.45</td> </tr> </tbody> </table> <p>SMC Plug to SMC Jack Right Angle Model No: <a href="#">PE9303</a></p>	PRICE		1-24	\$62.15	25-49	\$59.04	50-99	\$55.94	100+	\$53.45	 <table border="1"> <thead> <tr> <th colspan="2">PRICE</th> </tr> </thead> <tbody> <tr> <td>1-24</td> <td>\$44.16</td> </tr> <tr> <td>25-49</td> <td>\$41.95</td> </tr> <tr> <td>50-99</td> <td>\$39.74</td> </tr> <tr> <td>100+</td> <td>\$37.98</td> </tr> </tbody> </table> <p>SMC Jack to SMC Plug Tee Max. Freq. 100 MHz Model No: <a href="#">PE9242</a></p>	PRICE		1-24	\$44.16	25-49	\$41.95	50-99	\$39.74	100+	\$37.98	 <table border="1"> <thead> <tr> <th colspan="2">PRICE</th> </tr> </thead> <tbody> <tr> <td>1-24</td> <td>\$31.39</td> </tr> <tr> <td>25-49</td> <td>\$29.82</td> </tr> <tr> <td>50-99</td> <td>\$28.25</td> </tr> <tr> <td>100+</td> <td>\$27.00</td> </tr> </tbody> </table> <p>SMC Jack to SMC Jack Model No: <a href="#">PE9115</a></p>	PRICE		1-24	\$31.39	25-49	\$29.82	50-99	\$28.25	100+	\$27.00
PRICE																																																							
1-24	\$56.51																																																						
25-49	\$53.68																																																						
50-99	\$50.86																																																						
100+	\$48.60																																																						
PRICE																																																							
1-24	\$48.44																																																						
25-49	\$46.02																																																						
50-99	\$43.60																																																						
100+	\$41.66																																																						
PRICE																																																							
1-24	\$62.15																																																						
25-49	\$59.04																																																						
50-99	\$55.94																																																						
100+	\$53.45																																																						
PRICE																																																							
1-24	\$44.16																																																						
25-49	\$41.95																																																						
50-99	\$39.74																																																						
100+	\$37.98																																																						
PRICE																																																							
1-24	\$31.39																																																						
25-49	\$29.82																																																						
50-99	\$28.25																																																						
100+	\$27.00																																																						



# ADAPTERS

See Adapter Locator on Pages 8-13

See Page 369 for Mounting Holes

Adapters

See Our Website For Current Pricing & Real-Time Stock Availability!

	A	B	C	D	E																																																		
1	 <table border="1"> <thead> <tr><th colspan="2">PRICE</th></tr> </thead> <tbody> <tr><td>1-24</td><td>\$64.71</td></tr> <tr><td>25-49</td><td>\$61.47</td></tr> <tr><td>50-99</td><td>\$58.24</td></tr> <tr><td>100+</td><td>\$55.65</td></tr> </tbody> </table> <p>SMC Jack to SMC Jack Tee</p> <p>Model No: <a href="#">PE9304</a></p>	PRICE		1-24	\$64.71	25-49	\$61.47	50-99	\$58.24	100+	\$55.65	 <table border="1"> <thead> <tr><th colspan="2">PRICE</th></tr> </thead> <tbody> <tr><td>1-24</td><td>\$33.15</td></tr> <tr><td>25-49</td><td>\$31.49</td></tr> <tr><td>50-99</td><td>\$29.84</td></tr> <tr><td>100+</td><td>\$28.51</td></tr> </tbody> </table> <p>NEW</p> <p>SMC Jack to SMC Jack Bulkhead-Mounting Hole B01 Max. Freq. 10 GHz</p> <p>Model No: <a href="#">PE91403</a></p>	PRICE		1-24	\$33.15	25-49	\$31.49	50-99	\$29.84	100+	\$28.51	<p><b>SMC</b> <i>Between Series</i></p> <p>→</p>		 <table border="1"> <thead> <tr><th colspan="2">PRICE</th></tr> </thead> <tbody> <tr><td>1-24</td><td>\$57.18</td></tr> <tr><td>25-49</td><td>\$54.32</td></tr> <tr><td>50-99</td><td>\$51.46</td></tr> <tr><td>100+</td><td>\$49.17</td></tr> </tbody> </table> <p>SMC Plug to BNC Male</p> <p>Model No: <a href="#">PE9139</a></p>	PRICE		1-24	\$57.18	25-49	\$54.32	50-99	\$51.46	100+	\$49.17	 <table border="1"> <thead> <tr><th colspan="2">PRICE</th></tr> </thead> <tbody> <tr><td>1-24</td><td>\$56.29</td></tr> <tr><td>25-49</td><td>\$53.48</td></tr> <tr><td>50-99</td><td>\$50.66</td></tr> <tr><td>100+</td><td>\$48.41</td></tr> </tbody> </table> <p>SMC Plug to BNC Female</p> <p>VSWR 1.3:1 to 4 GHz</p> <p>Model No: <a href="#">PE9141</a></p>	PRICE		1-24	\$56.29	25-49	\$53.48	50-99	\$50.66	100+	\$48.41									
	PRICE																																																						
1-24	\$64.71																																																						
25-49	\$61.47																																																						
50-99	\$58.24																																																						
100+	\$55.65																																																						
PRICE																																																							
1-24	\$33.15																																																						
25-49	\$31.49																																																						
50-99	\$29.84																																																						
100+	\$28.51																																																						
PRICE																																																							
1-24	\$57.18																																																						
25-49	\$54.32																																																						
50-99	\$51.46																																																						
100+	\$49.17																																																						
PRICE																																																							
1-24	\$56.29																																																						
25-49	\$53.48																																																						
50-99	\$50.66																																																						
100+	\$48.41																																																						
2	 <table border="1"> <thead> <tr><th colspan="2">PRICE</th></tr> </thead> <tbody> <tr><td>1-24</td><td>\$84.40</td></tr> <tr><td>25-49</td><td>\$80.18</td></tr> <tr><td>50-99</td><td>\$75.96</td></tr> <tr><td>100+</td><td>\$72.58</td></tr> </tbody> </table> <p>SMC Plug to SMB Plug</p> <p>Model No: <a href="#">PE9281</a></p>	PRICE		1-24	\$84.40	25-49	\$80.18	50-99	\$75.96	100+	\$72.58	 <table border="1"> <thead> <tr><th colspan="2">PRICE</th></tr> </thead> <tbody> <tr><td>1-24</td><td>\$46.42</td></tr> <tr><td>25-49</td><td>\$44.10</td></tr> <tr><td>50-99</td><td>\$41.78</td></tr> <tr><td>100+</td><td>\$39.92</td></tr> </tbody> </table> <p>SMC Plug to SMB Jack</p> <p>Model No: <a href="#">PE9284</a></p>	PRICE		1-24	\$46.42	25-49	\$44.10	50-99	\$41.78	100+	\$39.92	 <table border="1"> <thead> <tr><th colspan="2">PRICE</th></tr> </thead> <tbody> <tr><td>1-24</td><td>\$56.29</td></tr> <tr><td>25-49</td><td>\$53.48</td></tr> <tr><td>50-99</td><td>\$50.66</td></tr> <tr><td>100+</td><td>\$48.41</td></tr> </tbody> </table> <p>SMC Jack to BNC Male</p> <p>Model No: <a href="#">PE9138</a></p>	PRICE		1-24	\$56.29	25-49	\$53.48	50-99	\$50.66	100+	\$48.41	 <table border="1"> <thead> <tr><th colspan="2">PRICE</th></tr> </thead> <tbody> <tr><td>1-24</td><td>\$65.61</td></tr> <tr><td>25-49</td><td>\$62.33</td></tr> <tr><td>50-99</td><td>\$59.05</td></tr> <tr><td>100+</td><td>\$56.42</td></tr> </tbody> </table> <p>SMC Jack to BNC Female</p> <p>VSWR 1.35:1 to 4 GHz</p> <p>Model No: <a href="#">PE9140</a></p>	PRICE		1-24	\$65.61	25-49	\$62.33	50-99	\$59.05	100+	\$56.42	 <table border="1"> <thead> <tr><th colspan="2">PRICE</th></tr> </thead> <tbody> <tr><td>1-24</td><td>\$77.33</td></tr> <tr><td>25-49</td><td>\$73.46</td></tr> <tr><td>50-99</td><td>\$69.60</td></tr> <tr><td>100+</td><td>\$66.50</td></tr> </tbody> </table> <p>SMC Jack to BNC Female Bulkhead</p> <p>Model No: <a href="#">PE9108</a></p>	PRICE		1-24	\$77.33	25-49	\$73.46	50-99	\$69.60	100+	\$66.50
	PRICE																																																						
1-24	\$84.40																																																						
25-49	\$80.18																																																						
50-99	\$75.96																																																						
100+	\$72.58																																																						
PRICE																																																							
1-24	\$46.42																																																						
25-49	\$44.10																																																						
50-99	\$41.78																																																						
100+	\$39.92																																																						
PRICE																																																							
1-24	\$56.29																																																						
25-49	\$53.48																																																						
50-99	\$50.66																																																						
100+	\$48.41																																																						
PRICE																																																							
1-24	\$65.61																																																						
25-49	\$62.33																																																						
50-99	\$59.05																																																						
100+	\$56.42																																																						
PRICE																																																							
1-24	\$77.33																																																						
25-49	\$73.46																																																						
50-99	\$69.60																																																						
100+	\$66.50																																																						
3	 <table border="1"> <thead> <tr><th colspan="2">PRICE</th></tr> </thead> <tbody> <tr><td>1-24</td><td>\$54.55</td></tr> <tr><td>25-49</td><td>\$51.82</td></tr> <tr><td>50-99</td><td>\$49.10</td></tr> <tr><td>100+</td><td>\$46.91</td></tr> </tbody> </table> <p>SMC Jack to SMB Plug</p> <p>Model No: <a href="#">PE9282</a></p>	PRICE		1-24	\$54.55	25-49	\$51.82	50-99	\$49.10	100+	\$46.91	 <table border="1"> <thead> <tr><th colspan="2">PRICE</th></tr> </thead> <tbody> <tr><td>1-24</td><td>\$55.98</td></tr> <tr><td>25-49</td><td>\$53.18</td></tr> <tr><td>50-99</td><td>\$50.38</td></tr> <tr><td>100+</td><td>\$48.14</td></tr> </tbody> </table> <p>SMC Jack to SMB Jack</p> <p>Model No: <a href="#">PE9283</a></p>	PRICE		1-24	\$55.98	25-49	\$53.18	50-99	\$50.38	100+	\$48.14	<p><b>SMP</b> <i>In-Series</i></p> <p>→</p>		 <table border="1"> <thead> <tr><th colspan="2">PRICE</th></tr> </thead> <tbody> <tr><td>1-24</td><td>\$20.98</td></tr> <tr><td>25-49</td><td>\$19.93</td></tr> <tr><td>50-99</td><td>\$18.88</td></tr> <tr><td>100+</td><td>\$18.04</td></tr> </tbody> </table> <p>SMP Female to SMP Female</p> <p>VSWR 1.2:1 to 12 GHz</p> <p>Model No: <a href="#">PE91102</a></p>	PRICE		1-24	\$20.98	25-49	\$19.93	50-99	\$18.88	100+	\$18.04	 <table border="1"> <thead> <tr><th colspan="2">PRICE</th></tr> </thead> <tbody> <tr><td>1-24</td><td>\$81.24</td></tr> <tr><td>25-49</td><td>\$77.18</td></tr> <tr><td>50-99</td><td>\$73.12</td></tr> <tr><td>100+</td><td>\$69.87</td></tr> </tbody> </table> <p>SMP Female to SMP Female</p> <p>Max. Freq. 26.5 GHz</p> <p>Model No: <a href="#">PE9776</a></p>	PRICE		1-24	\$81.24	25-49	\$77.18	50-99	\$73.12	100+	\$69.87									
	PRICE																																																						
1-24	\$54.55																																																						
25-49	\$51.82																																																						
50-99	\$49.10																																																						
100+	\$46.91																																																						
PRICE																																																							
1-24	\$55.98																																																						
25-49	\$53.18																																																						
50-99	\$50.38																																																						
100+	\$48.14																																																						
PRICE																																																							
1-24	\$20.98																																																						
25-49	\$19.93																																																						
50-99	\$18.88																																																						
100+	\$18.04																																																						
PRICE																																																							
1-24	\$81.24																																																						
25-49	\$77.18																																																						
50-99	\$73.12																																																						
100+	\$69.87																																																						
4	 <table border="1"> <thead> <tr><th colspan="2">PRICE</th></tr> </thead> <tbody> <tr><td>1-24</td><td>\$21.84</td></tr> <tr><td>25-49</td><td>\$20.75</td></tr> <tr><td>50-99</td><td>\$19.66</td></tr> <tr><td>100+</td><td>\$18.78</td></tr> </tbody> </table> <p>SMP Female to SMP Female</p> <p>VSWR 1.2:1 to 8 GHz</p> <p>Model No: <a href="#">PE91068</a></p>	PRICE		1-24	\$21.84	25-49	\$20.75	50-99	\$19.66	100+	\$18.78	 <table border="1"> <thead> <tr><th colspan="2">PRICE</th></tr> </thead> <tbody> <tr><td>1-24</td><td>\$33.30</td></tr> <tr><td>25-49</td><td>\$31.64</td></tr> <tr><td>50-99</td><td>\$29.97</td></tr> <tr><td>100+</td><td>\$28.64</td></tr> </tbody> </table> <p>SMP Female to SMP Female</p> <p>Max. Freq. 40 GHz</p> <p>Model No: <a href="#">PE91072</a></p>	PRICE		1-24	\$33.30	25-49	\$31.64	50-99	\$29.97	100+	\$28.64	 <table border="1"> <thead> <tr><th colspan="2">PRICE</th></tr> </thead> <tbody> <tr><td>1-24</td><td>\$33.56</td></tr> <tr><td>25-49</td><td>\$31.88</td></tr> <tr><td>50-99</td><td>\$30.20</td></tr> <tr><td>100+</td><td>\$28.86</td></tr> </tbody> </table> <p>SMP Female to SMP Female</p> <p>Max. Freq. 40 GHz</p> <p>Model No: <a href="#">PE91099</a></p>	PRICE		1-24	\$33.56	25-49	\$31.88	50-99	\$30.20	100+	\$28.86	 <table border="1"> <thead> <tr><th colspan="2">PRICE</th></tr> </thead> <tbody> <tr><td>1-24</td><td>\$13.98</td></tr> <tr><td>25-49</td><td>\$13.28</td></tr> <tr><td>50-99</td><td>\$12.58</td></tr> <tr><td>100+</td><td>\$12.02</td></tr> </tbody> </table> <p>SMP Female to SMP Female</p> <p>VSWR 1.2:1 to 8 GHz</p> <p>Model No: <a href="#">PE91101</a></p>	PRICE		1-24	\$13.98	25-49	\$13.28	50-99	\$12.58	100+	\$12.02	 <table border="1"> <thead> <tr><th colspan="2">PRICE</th></tr> </thead> <tbody> <tr><td>1-24</td><td>\$68.11</td></tr> <tr><td>25-49</td><td>\$64.70</td></tr> <tr><td>50-99</td><td>\$61.30</td></tr> <tr><td>100+</td><td>\$58.57</td></tr> </tbody> </table> <p>SMP Female to SMP Female</p> <p>Max. Freq. 26.5 GHz</p> <p>Model No: <a href="#">PE9775</a></p>	PRICE		1-24	\$68.11	25-49	\$64.70	50-99	\$61.30	100+	\$58.57
	PRICE																																																						
1-24	\$21.84																																																						
25-49	\$20.75																																																						
50-99	\$19.66																																																						
100+	\$18.78																																																						
PRICE																																																							
1-24	\$33.30																																																						
25-49	\$31.64																																																						
50-99	\$29.97																																																						
100+	\$28.64																																																						
PRICE																																																							
1-24	\$33.56																																																						
25-49	\$31.88																																																						
50-99	\$30.20																																																						
100+	\$28.86																																																						
PRICE																																																							
1-24	\$13.98																																																						
25-49	\$13.28																																																						
50-99	\$12.58																																																						
100+	\$12.02																																																						
PRICE																																																							
1-24	\$68.11																																																						
25-49	\$64.70																																																						
50-99	\$61.30																																																						
100+	\$58.57																																																						
5	 <table border="1"> <thead> <tr><th colspan="2">PRICE</th></tr> </thead> <tbody> <tr><td>1-24</td><td>\$43.53</td></tr> <tr><td>25-49</td><td>\$41.35</td></tr> <tr><td>50-99</td><td>\$39.18</td></tr> <tr><td>100+</td><td>\$37.44</td></tr> </tbody> </table> <p>SMP Female to SMP Female</p> <p>Max. Freq. 26.5 GHz</p> <p>Model No: <a href="#">PE9777</a></p>	PRICE		1-24	\$43.53	25-49	\$41.35	50-99	\$39.18	100+	\$37.44	<p><b>SMP</b> <i>Between Series</i></p> <p>→</p>		 <table border="1"> <thead> <tr><th colspan="2">PRICE</th></tr> </thead> <tbody> <tr><td>1-24</td><td>\$12.24</td></tr> <tr><td>25-49</td><td>\$11.63</td></tr> <tr><td>50-99</td><td>\$11.02</td></tr> <tr><td>100+</td><td>\$10.53</td></tr> </tbody> </table> <p>NEW</p> <p>Push-On SMP Female to Snap-On MMBX Plug</p> <p>VSWR 1.25:1 to 6 GHz</p> <p>Model No: <a href="#">PE91364</a></p>	PRICE		1-24	\$12.24	25-49	\$11.63	50-99	\$11.02	100+	\$10.53	 <table border="1"> <thead> <tr><th colspan="2">PRICE</th></tr> </thead> <tbody> <tr><td>1-24</td><td>\$27.22</td></tr> <tr><td>25-49</td><td>\$25.86</td></tr> <tr><td>50-99</td><td>\$24.50</td></tr> <tr><td>100+</td><td>\$23.41</td></tr> </tbody> </table> <p>SMP Female to SMP Female</p> <p>Max. Freq. 40 GHz</p> <p>Model No: <a href="#">PE91065</a></p>	PRICE		1-24	\$27.22	25-49	\$25.86	50-99	\$24.50	100+	\$23.41	<p><b>SSMA</b> <i>In-Series</i></p> <p>→</p>																			
	PRICE																																																						
1-24	\$43.53																																																						
25-49	\$41.35																																																						
50-99	\$39.18																																																						
100+	\$37.44																																																						
PRICE																																																							
1-24	\$12.24																																																						
25-49	\$11.63																																																						
50-99	\$11.02																																																						
100+	\$10.53																																																						
PRICE																																																							
1-24	\$27.22																																																						
25-49	\$25.86																																																						
50-99	\$24.50																																																						
100+	\$23.41																																																						
6	 <table border="1"> <thead> <tr><th colspan="2">PRICE</th></tr> </thead> <tbody> <tr><td>1-9</td><td>\$112.53</td></tr> <tr><td>10-24</td><td>\$106.90</td></tr> <tr><td>25-49</td><td>\$101.28</td></tr> <tr><td>50+</td><td>\$96.78</td></tr> </tbody> </table> <p>SSMA Male to SSMA Male</p> <p>Model No: <a href="#">PE9357</a></p>	PRICE		1-9	\$112.53	10-24	\$106.90	25-49	\$101.28	50+	\$96.78	 <table border="1"> <thead> <tr><th colspan="2">PRICE</th></tr> </thead> <tbody> <tr><td>1-24</td><td>\$71.18</td></tr> <tr><td>25-49</td><td>\$67.62</td></tr> <tr><td>50-99</td><td>\$64.06</td></tr> <tr><td>100+</td><td>\$61.21</td></tr> </tbody> </table> <p>SSMA Male to SSMA Female</p> <p>Model No: <a href="#">PE9358</a></p>	PRICE		1-24	\$71.18	25-49	\$67.62	50-99	\$64.06	100+	\$61.21	 <table border="1"> <thead> <tr><th colspan="2">PRICE</th></tr> </thead> <tbody> <tr><td>1-9</td><td>\$168.39</td></tr> <tr><td>10-24</td><td>\$159.97</td></tr> <tr><td>25-49</td><td>\$151.55</td></tr> <tr><td>50+</td><td>\$144.82</td></tr> </tbody> </table> <p>QD SSMA Male to SSMA Female</p> <p>Model No: <a href="#">PE9685</a></p>	PRICE		1-9	\$168.39	10-24	\$159.97	25-49	\$151.55	50+	\$144.82	 <table border="1"> <thead> <tr><th colspan="2">PRICE</th></tr> </thead> <tbody> <tr><td>1-24</td><td>\$88.13</td></tr> <tr><td>25-49</td><td>\$83.72</td></tr> <tr><td>50-99</td><td>\$79.32</td></tr> <tr><td>100+</td><td>\$75.79</td></tr> </tbody> </table> <p>SSMA Male to SSMA Female Right Angle</p> <p>VSWR 1.3:1 to 18 GHz</p> <p>Model No: <a href="#">PE9334</a></p>	PRICE		1-24	\$88.13	25-49	\$83.72	50-99	\$79.32	100+	\$75.79	 <table border="1"> <thead> <tr><th colspan="2">PRICE</th></tr> </thead> <tbody> <tr><td>1-24</td><td>\$62.84</td></tr> <tr><td>25-49</td><td>\$59.70</td></tr> <tr><td>50-99</td><td>\$56.56</td></tr> <tr><td>100+</td><td>\$54.04</td></tr> </tbody> </table> <p>SSMA Female to SSMA Female</p> <p>VSWR 1.3:1 to 25 GHz</p> <p>Model No: <a href="#">PE9192</a></p>	PRICE		1-24	\$62.84	25-49	\$59.70	50-99	\$56.56	100+	\$54.04
	PRICE																																																						
1-9	\$112.53																																																						
10-24	\$106.90																																																						
25-49	\$101.28																																																						
50+	\$96.78																																																						
PRICE																																																							
1-24	\$71.18																																																						
25-49	\$67.62																																																						
50-99	\$64.06																																																						
100+	\$61.21																																																						
PRICE																																																							
1-9	\$168.39																																																						
10-24	\$159.97																																																						
25-49	\$151.55																																																						
50+	\$144.82																																																						
PRICE																																																							
1-24	\$88.13																																																						
25-49	\$83.72																																																						
50-99	\$79.32																																																						
100+	\$75.79																																																						
PRICE																																																							
1-24	\$62.84																																																						
25-49	\$59.70																																																						
50-99	\$56.56																																																						
100+	\$54.04																																																						
7	 <table border="1"> <thead> <tr><th colspan="2">PRICE</th></tr> </thead> <tbody> <tr><td>1-24</td><td>\$65.35</td></tr> <tr><td>25-49</td><td>\$62.08</td></tr> <tr><td>50-99</td><td>\$58.82</td></tr> <tr><td>100+</td><td>\$56.20</td></tr> </tbody> </table> <p>SSMA Female to SSMA Female Bulkhead-Mounting Hole B01</p> <p>Model No: <a href="#">PE9189</a></p>	PRICE		1-24	\$65.35	25-49	\$62.08	50-99	\$58.82	100+	\$56.20	<p><b>SSMA</b> <i>Between Series</i></p> <p>→</p>		 <table border="1"> <thead> <tr><th colspan="2">PRICE</th></tr> </thead> <tbody> <tr><td>1-9</td><td>\$123.51</td></tr> <tr><td>10-24</td><td>\$117.33</td></tr> <tr><td>25-49</td><td>\$111.16</td></tr> <tr><td>50+</td><td>\$106.22</td></tr> </tbody> </table> <p>SSMA Male to BNC Male</p> <p>Model No: <a href="#">PE9213</a></p>	PRICE		1-9	\$123.51	10-24	\$117.33	25-49	\$111.16	50+	\$106.22	 <table border="1"> <thead> <tr><th colspan="2">PRICE</th></tr> </thead> <tbody> <tr><td>1-24</td><td>\$111.74</td></tr> <tr><td>25-49</td><td>\$106.15</td></tr> <tr><td>50-99</td><td>\$100.57</td></tr> <tr><td>100+</td><td>\$96.10</td></tr> </tbody> </table> <p>SSMA Male to BNC Female</p> <p>Model No: <a href="#">PE91046</a></p>	PRICE		1-24	\$111.74	25-49	\$106.15	50-99	\$100.57	100+	\$96.10	 <table border="1"> <thead> <tr><th colspan="2">PRICE</th></tr> </thead> <tbody> <tr><td>1-24</td><td>\$96.07</td></tr> <tr><td>25-49</td><td>\$91.27</td></tr> <tr><td>50-99</td><td>\$86.46</td></tr> <tr><td>100+</td><td>\$82.62</td></tr> </tbody> </table> <p>SSMA Male to N Male</p> <p>Max. Freq. 11 GHz</p> <p>Model No: <a href="#">PE9351</a></p>	PRICE		1-24	\$96.07	25-49	\$91.27	50-99	\$86.46	100+	\$82.62									
	PRICE																																																						
1-24	\$65.35																																																						
25-49	\$62.08																																																						
50-99	\$58.82																																																						
100+	\$56.20																																																						
PRICE																																																							
1-9	\$123.51																																																						
10-24	\$117.33																																																						
25-49	\$111.16																																																						
50+	\$106.22																																																						
PRICE																																																							
1-24	\$111.74																																																						
25-49	\$106.15																																																						
50-99	\$100.57																																																						
100+	\$96.10																																																						
PRICE																																																							
1-24	\$96.07																																																						
25-49	\$91.27																																																						
50-99	\$86.46																																																						
100+	\$82.62																																																						



Technical Support  
+1 (949) 261-1920



Same-Day Shipping,  
Even Custom Cable Assemblies

# ADAPTERS

See Adapter Locator on Pages 8-13

See Page 369 for Mounting Holes

Adapters

See Our Website For Current Pricing & Real-Time Stock Availability!

	A	B	C	D	E																																																		
1	 <table border="1"> <thead> <tr> <th colspan="2">PRICE</th> </tr> </thead> <tbody> <tr><td>1-9</td><td>\$299.66</td></tr> <tr><td>10-24</td><td>\$284.68</td></tr> <tr><td>25-49</td><td>\$269.69</td></tr> <tr><td>50+</td><td>\$257.71</td></tr> </tbody> </table> <p>PRECISION SSMA Female to 7mm Sexless</p> <p>Model No: <a href="#">PE9356</a></p>	PRICE		1-9	\$299.66	10-24	\$284.68	25-49	\$269.69	50+	\$257.71	 <table border="1"> <thead> <tr> <th colspan="2">PRICE</th> </tr> </thead> <tbody> <tr><td>1-24</td><td>\$96.14</td></tr> <tr><td>25-49</td><td>\$92.29</td></tr> <tr><td>50-99</td><td>\$89.41</td></tr> <tr><td>100+</td><td>\$87.49</td></tr> </tbody> </table> <p>SSMA Female to BNC Male</p> <p>Model No: <a href="#">PE9191</a></p>	PRICE		1-24	\$96.14	25-49	\$92.29	50-99	\$89.41	100+	\$87.49	 <table border="1"> <thead> <tr> <th colspan="2">PRICE</th> </tr> </thead> <tbody> <tr><td>1-24</td><td>\$85.67</td></tr> <tr><td>25-49</td><td>\$81.39</td></tr> <tr><td>50-99</td><td>\$77.10</td></tr> <tr><td>100+</td><td>\$73.68</td></tr> </tbody> </table> <p>SSMA Female to N Male</p> <p>Model No: <a href="#">PE9352</a></p>	PRICE		1-24	\$85.67	25-49	\$81.39	50-99	\$77.10	100+	\$73.68	 <table border="1"> <thead> <tr> <th colspan="2">PRICE</th> </tr> </thead> <tbody> <tr><td>1-24</td><td>\$78.96</td></tr> <tr><td>25-49</td><td>\$75.01</td></tr> <tr><td>50-99</td><td>\$71.06</td></tr> <tr><td>100+</td><td>\$67.91</td></tr> </tbody> </table> <p>SSMA Female to N Female</p> <p>Model No: <a href="#">PE9354</a></p>	PRICE		1-24	\$78.96	25-49	\$75.01	50-99	\$71.06	100+	\$67.91	<p><b>SSMB Between Series</b></p> <p>→</p>										
PRICE																																																							
1-9	\$299.66																																																						
10-24	\$284.68																																																						
25-49	\$269.69																																																						
50+	\$257.71																																																						
PRICE																																																							
1-24	\$96.14																																																						
25-49	\$92.29																																																						
50-99	\$89.41																																																						
100+	\$87.49																																																						
PRICE																																																							
1-24	\$85.67																																																						
25-49	\$81.39																																																						
50-99	\$77.10																																																						
100+	\$73.68																																																						
PRICE																																																							
1-24	\$78.96																																																						
25-49	\$75.01																																																						
50-99	\$71.06																																																						
100+	\$67.91																																																						
2	 <table border="1"> <thead> <tr> <th colspan="2">PRICE</th> </tr> </thead> <tbody> <tr><td>1-24</td><td>\$86.06</td></tr> <tr><td>25-49</td><td>\$81.76</td></tr> <tr><td>50-99</td><td>\$77.45</td></tr> <tr><td>100+</td><td>\$74.01</td></tr> </tbody> </table> <p>SSMB Plug to BNC Male</p> <p>Model No: <a href="#">PE9393</a></p>	PRICE		1-24	\$86.06	25-49	\$81.76	50-99	\$77.45	100+	\$74.01	 <table border="1"> <thead> <tr> <th colspan="2">PRICE</th> </tr> </thead> <tbody> <tr><td>1-24</td><td>\$108.18</td></tr> <tr><td>25-49</td><td>\$102.77</td></tr> <tr><td>50-99</td><td>\$97.36</td></tr> <tr><td>100+</td><td>\$93.03</td></tr> </tbody> </table> <p>SSMB Plug to BNC Female</p> <p>Model No: <a href="#">PE9395</a></p>	PRICE		1-24	\$108.18	25-49	\$102.77	50-99	\$97.36	100+	\$93.03	 <table border="1"> <thead> <tr> <th colspan="2">PRICE</th> </tr> </thead> <tbody> <tr><td>1-24</td><td>\$111.34</td></tr> <tr><td>25-49</td><td>\$105.77</td></tr> <tr><td>50-99</td><td>\$100.21</td></tr> <tr><td>100+</td><td>\$95.75</td></tr> </tbody> </table> <p>SSMB Jack to BNC Male</p> <p>Model No: <a href="#">PE9392</a></p>	PRICE		1-24	\$111.34	25-49	\$105.77	50-99	\$100.21	100+	\$95.75	 <table border="1"> <thead> <tr> <th colspan="2">PRICE</th> </tr> </thead> <tbody> <tr><td>1-24</td><td>\$111.30</td></tr> <tr><td>25-49</td><td>\$105.74</td></tr> <tr><td>50-99</td><td>\$100.17</td></tr> <tr><td>100+</td><td>\$95.72</td></tr> </tbody> </table> <p>SSMB Jack to BNC Female</p> <p>Model No: <a href="#">PE9394</a></p>	PRICE		1-24	\$111.30	25-49	\$105.74	50-99	\$100.17	100+	\$95.72	<p><b>SSMC In-Series</b></p> <p>→</p>										
PRICE																																																							
1-24	\$86.06																																																						
25-49	\$81.76																																																						
50-99	\$77.45																																																						
100+	\$74.01																																																						
PRICE																																																							
1-24	\$108.18																																																						
25-49	\$102.77																																																						
50-99	\$97.36																																																						
100+	\$93.03																																																						
PRICE																																																							
1-24	\$111.34																																																						
25-49	\$105.77																																																						
50-99	\$100.21																																																						
100+	\$95.75																																																						
PRICE																																																							
1-24	\$111.30																																																						
25-49	\$105.74																																																						
50-99	\$100.17																																																						
100+	\$95.72																																																						
3	 <table border="1"> <thead> <tr> <th colspan="2">PRICE</th> </tr> </thead> <tbody> <tr><td>1-24</td><td>\$52.13</td></tr> <tr><td>25-49</td><td>\$50.04</td></tr> <tr><td>50-99</td><td>\$48.48</td></tr> <tr><td>100+</td><td>\$47.44</td></tr> </tbody> </table> <p>NEW SSMC Plug to SSMC Plug VSWR 1.25:1 to 12 GHz</p> <p>Model No: <a href="#">PE91436</a></p>	PRICE		1-24	\$52.13	25-49	\$50.04	50-99	\$48.48	100+	\$47.44	 <table border="1"> <thead> <tr> <th colspan="2">PRICE</th> </tr> </thead> <tbody> <tr><td>1-24</td><td>\$52.13</td></tr> <tr><td>25-49</td><td>\$49.52</td></tr> <tr><td>50-99</td><td>\$46.92</td></tr> <tr><td>100+</td><td>\$44.83</td></tr> </tbody> </table> <p>NEW SSMC Plug to SSMC Jack VSWR 1.25:1 to 12 GHz</p> <p>Model No: <a href="#">PE91434</a></p>	PRICE		1-24	\$52.13	25-49	\$49.52	50-99	\$46.92	100+	\$44.83	 <table border="1"> <thead> <tr> <th colspan="2">PRICE</th> </tr> </thead> <tbody> <tr><td>1-24</td><td>\$52.13</td></tr> <tr><td>25-49</td><td>\$49.52</td></tr> <tr><td>50-99</td><td>\$46.92</td></tr> <tr><td>100+</td><td>\$44.83</td></tr> </tbody> </table> <p>NEW SSMC Jack to SSMC Jack Bulkhead VSWR 1.25:1 to 4 GHz</p> <p>Model No: <a href="#">PE91432</a></p>	PRICE		1-24	\$52.13	25-49	\$49.52	50-99	\$46.92	100+	\$44.83	<p><b>TNC In-Series</b></p> <p>→</p>	 <table border="1"> <thead> <tr> <th colspan="2">PRICE</th> </tr> </thead> <tbody> <tr><td>1-24</td><td>\$61.44</td></tr> <tr><td>25-49</td><td>\$58.37</td></tr> <tr><td>50-99</td><td>\$55.30</td></tr> <tr><td>100+</td><td>\$52.84</td></tr> </tbody> </table> <p>Low PIM TNC Male to TNC Male VSWR 1.25:1 to 6 GHz</p> <p>Model No: <a href="#">PE91172</a></p>	PRICE		1-24	\$61.44	25-49	\$58.37	50-99	\$55.30	100+	\$52.84										
PRICE																																																							
1-24	\$52.13																																																						
25-49	\$50.04																																																						
50-99	\$48.48																																																						
100+	\$47.44																																																						
PRICE																																																							
1-24	\$52.13																																																						
25-49	\$49.52																																																						
50-99	\$46.92																																																						
100+	\$44.83																																																						
PRICE																																																							
1-24	\$52.13																																																						
25-49	\$49.52																																																						
50-99	\$46.92																																																						
100+	\$44.83																																																						
PRICE																																																							
1-24	\$61.44																																																						
25-49	\$58.37																																																						
50-99	\$55.30																																																						
100+	\$52.84																																																						
4	 <table border="1"> <thead> <tr> <th colspan="2">PRICE</th> </tr> </thead> <tbody> <tr><td>1-24</td><td>\$52.91</td></tr> <tr><td>25-49</td><td>\$50.26</td></tr> <tr><td>50-99</td><td>\$47.62</td></tr> <tr><td>100+</td><td>\$45.50</td></tr> </tbody> </table> <p>TNC Male to TNC Male VSWR 1.2:1 to 6 GHz</p> <p>Model No: <a href="#">PE91202</a></p>	PRICE		1-24	\$52.91	25-49	\$50.26	50-99	\$47.62	100+	\$45.50	 <table border="1"> <thead> <tr> <th colspan="2">PRICE</th> </tr> </thead> <tbody> <tr><td>1-24</td><td>\$51.97</td></tr> <tr><td>25-49</td><td>\$49.37</td></tr> <tr><td>50-99</td><td>\$46.77</td></tr> <tr><td>100+</td><td>\$44.69</td></tr> </tbody> </table> <p>TNC Male to TNC Male VSWR 1.3:1 to 6 GHz</p> <p>Model No: <a href="#">PE91239</a></p>	PRICE		1-24	\$51.97	25-49	\$49.37	50-99	\$46.77	100+	\$44.69	 <table border="1"> <thead> <tr> <th colspan="2">PRICE</th> </tr> </thead> <tbody> <tr><td>1-24</td><td>\$35.15</td></tr> <tr><td>25-49</td><td>\$33.39</td></tr> <tr><td>50-99</td><td>\$31.64</td></tr> <tr><td>100+</td><td>\$30.23</td></tr> </tbody> </table> <p>TNC Male to TNC Male VSWR 1.3:1 to 1,000 MHz</p> <p>Model No: <a href="#">PE9091</a></p>	PRICE		1-24	\$35.15	25-49	\$33.39	50-99	\$31.64	100+	\$30.23	 <table border="1"> <thead> <tr> <th colspan="2">PRICE</th> </tr> </thead> <tbody> <tr><td>1-9</td><td>\$159.25</td></tr> <tr><td>10-24</td><td>\$151.29</td></tr> <tr><td>25-49</td><td>\$143.33</td></tr> <tr><td>50+</td><td>\$136.96</td></tr> </tbody> </table> <p>TNC Male to TNC Male VSWR 1.25:1 to 18 GHz</p> <p>Model No: <a href="#">PE9445</a></p>	PRICE		1-9	\$159.25	10-24	\$151.29	25-49	\$143.33	50+	\$136.96	 <table border="1"> <thead> <tr> <th colspan="2">PRICE</th> </tr> </thead> <tbody> <tr><td>1-24</td><td>\$93.02</td></tr> <tr><td>25-49</td><td>\$88.37</td></tr> <tr><td>50-99</td><td>\$83.72</td></tr> <tr><td>100+</td><td>\$80.00</td></tr> </tbody> </table> <p>TNC Male to TNC Male Right Angle</p> <p>Model No: <a href="#">PE9560</a></p>	PRICE		1-24	\$93.02	25-49	\$88.37	50-99	\$83.72	100+	\$80.00
PRICE																																																							
1-24	\$52.91																																																						
25-49	\$50.26																																																						
50-99	\$47.62																																																						
100+	\$45.50																																																						
PRICE																																																							
1-24	\$51.97																																																						
25-49	\$49.37																																																						
50-99	\$46.77																																																						
100+	\$44.69																																																						
PRICE																																																							
1-24	\$35.15																																																						
25-49	\$33.39																																																						
50-99	\$31.64																																																						
100+	\$30.23																																																						
PRICE																																																							
1-9	\$159.25																																																						
10-24	\$151.29																																																						
25-49	\$143.33																																																						
50+	\$136.96																																																						
PRICE																																																							
1-24	\$93.02																																																						
25-49	\$88.37																																																						
50-99	\$83.72																																																						
100+	\$80.00																																																						
5	 <table border="1"> <thead> <tr> <th colspan="2">PRICE</th> </tr> </thead> <tbody> <tr><td>1-24</td><td>\$52.91</td></tr> <tr><td>25-49</td><td>\$50.26</td></tr> <tr><td>50-99</td><td>\$47.62</td></tr> <tr><td>100+</td><td>\$45.50</td></tr> </tbody> </table> <p>TNC Male to TNC Female VSWR 1.2:1 to 6 GHz</p> <p>Model No: <a href="#">PE91203</a></p>	PRICE		1-24	\$52.91	25-49	\$50.26	50-99	\$47.62	100+	\$45.50	 <table border="1"> <thead> <tr> <th colspan="2">PRICE</th> </tr> </thead> <tbody> <tr><td>1-24</td><td>\$51.66</td></tr> <tr><td>25-49</td><td>\$49.08</td></tr> <tr><td>50-99</td><td>\$46.49</td></tr> <tr><td>100+</td><td>\$44.43</td></tr> </tbody> </table> <p>TNC Male to TNC Female VSWR 1.3:1 to 6 GHz</p> <p>Model No: <a href="#">PE91240</a></p>	PRICE		1-24	\$51.66	25-49	\$49.08	50-99	\$46.49	100+	\$44.43	 <table border="1"> <thead> <tr> <th colspan="2">PRICE</th> </tr> </thead> <tbody> <tr><td>1-24</td><td>\$69.69</td></tr> <tr><td>25-49</td><td>\$64.81</td></tr> <tr><td>50-99</td><td>\$59.93</td></tr> <tr><td>100+</td><td>\$55.75</td></tr> </tbody> </table> <p>PRECISION TNC Male to TNC Female VSWR 1.15:1 to 18 GHz</p> <p>Model No: <a href="#">PE91505</a></p>	PRICE		1-24	\$69.69	25-49	\$64.81	50-99	\$59.93	100+	\$55.75	 <table border="1"> <thead> <tr> <th colspan="2">PRICE</th> </tr> </thead> <tbody> <tr><td>1-24</td><td>\$58.54</td></tr> <tr><td>25-49</td><td>\$55.61</td></tr> <tr><td>50-99</td><td>\$52.69</td></tr> <tr><td>100+</td><td>\$50.34</td></tr> </tbody> </table> <p>Low PIM TNC Male to TNC Female VSWR 1.25:1 to 6 GHz</p> <p>Model No: <a href="#">PE91173</a></p>	PRICE		1-24	\$58.54	25-49	\$55.61	50-99	\$52.69	100+	\$50.34	 <table border="1"> <thead> <tr> <th colspan="2">PRICE</th> </tr> </thead> <tbody> <tr><td>1-24</td><td>\$24.23</td></tr> <tr><td>25-49</td><td>\$23.02</td></tr> <tr><td>50-99</td><td>\$21.81</td></tr> <tr><td>100+</td><td>\$20.84</td></tr> </tbody> </table> <p>TNC Male to TNC Female VSWR 1.5:1 to 11 GHz</p> <p>Model No: <a href="#">PE9270</a></p>	PRICE		1-24	\$24.23	25-49	\$23.02	50-99	\$21.81	100+	\$20.84
PRICE																																																							
1-24	\$52.91																																																						
25-49	\$50.26																																																						
50-99	\$47.62																																																						
100+	\$45.50																																																						
PRICE																																																							
1-24	\$51.66																																																						
25-49	\$49.08																																																						
50-99	\$46.49																																																						
100+	\$44.43																																																						
PRICE																																																							
1-24	\$69.69																																																						
25-49	\$64.81																																																						
50-99	\$59.93																																																						
100+	\$55.75																																																						
PRICE																																																							
1-24	\$58.54																																																						
25-49	\$55.61																																																						
50-99	\$52.69																																																						
100+	\$50.34																																																						
PRICE																																																							
1-24	\$24.23																																																						
25-49	\$23.02																																																						
50-99	\$21.81																																																						
100+	\$20.84																																																						
6	 <table border="1"> <thead> <tr> <th colspan="2">PRICE</th> </tr> </thead> <tbody> <tr><td>1-24</td><td>\$132.70</td></tr> <tr><td>25-49</td><td>\$123.41</td></tr> <tr><td>50-99</td><td>\$114.12</td></tr> <tr><td>100+</td><td>\$106.16</td></tr> </tbody> </table> <p>PRECISION TNC Male to TNC Female VSWR 1.15:1 to 18 GHz</p> <p>Model No: <a href="#">PE9443</a></p>	PRICE		1-24	\$132.70	25-49	\$123.41	50-99	\$114.12	100+	\$106.16	 <table border="1"> <thead> <tr> <th colspan="2">PRICE</th> </tr> </thead> <tbody> <tr><td>1-9</td><td>\$188.44</td></tr> <tr><td>10-24</td><td>\$179.02</td></tr> <tr><td>25-49</td><td>\$169.60</td></tr> <tr><td>50+</td><td>\$162.06</td></tr> </tbody> </table> <p>QD TNC Male to TNC Female</p> <p>Model No: <a href="#">PE9561</a></p>	PRICE		1-9	\$188.44	10-24	\$179.02	25-49	\$169.60	50+	\$162.06	 <table border="1"> <thead> <tr> <th colspan="2">PRICE</th> </tr> </thead> <tbody> <tr><td>1-24</td><td>\$33.06</td></tr> <tr><td>25-49</td><td>\$31.41</td></tr> <tr><td>50-99</td><td>\$29.75</td></tr> <tr><td>100+</td><td>\$28.43</td></tr> </tbody> </table> <p>TNC Male to TNC Female Right Angle Max. Freq. 11 GHz</p> <p>Model No: <a href="#">PE9100</a></p>	PRICE		1-24	\$33.06	25-49	\$31.41	50-99	\$29.75	100+	\$28.43	 <table border="1"> <thead> <tr> <th colspan="2">PRICE</th> </tr> </thead> <tbody> <tr><td>1-24</td><td>\$86.05</td></tr> <tr><td>25-49</td><td>\$81.75</td></tr> <tr><td>50-99</td><td>\$77.45</td></tr> <tr><td>100+</td><td>\$74.00</td></tr> </tbody> </table> <p>TNC Male to TNC Female Tee</p> <p>Model No: <a href="#">PE9290</a></p>	PRICE		1-24	\$86.05	25-49	\$81.75	50-99	\$77.45	100+	\$74.00	 <table border="1"> <thead> <tr> <th colspan="2">PRICE</th> </tr> </thead> <tbody> <tr><td>1-24</td><td>\$28.32</td></tr> <tr><td>25-49</td><td>\$26.90</td></tr> <tr><td>50-99</td><td>\$25.49</td></tr> <tr><td>100+</td><td>\$24.36</td></tr> </tbody> </table> <p>TNC Female to TNC Male Tee Max. Freq. 11 GHz</p> <p>Model No: <a href="#">PE9195</a></p>	PRICE		1-24	\$28.32	25-49	\$26.90	50-99	\$25.49	100+	\$24.36
PRICE																																																							
1-24	\$132.70																																																						
25-49	\$123.41																																																						
50-99	\$114.12																																																						
100+	\$106.16																																																						
PRICE																																																							
1-9	\$188.44																																																						
10-24	\$179.02																																																						
25-49	\$169.60																																																						
50+	\$162.06																																																						
PRICE																																																							
1-24	\$33.06																																																						
25-49	\$31.41																																																						
50-99	\$29.75																																																						
100+	\$28.43																																																						
PRICE																																																							
1-24	\$86.05																																																						
25-49	\$81.75																																																						
50-99	\$77.45																																																						
100+	\$74.00																																																						
PRICE																																																							
1-24	\$28.32																																																						
25-49	\$26.90																																																						
50-99	\$25.49																																																						
100+	\$24.36																																																						
7	 <table border="1"> <thead> <tr> <th colspan="2">PRICE</th> </tr> </thead> <tbody> <tr><td>1-24</td><td>\$52.91</td></tr> <tr><td>25-49</td><td>\$50.26</td></tr> <tr><td>50-99</td><td>\$47.62</td></tr> <tr><td>100+</td><td>\$45.50</td></tr> </tbody> </table> <p>TNC Female to TNC Female VSWR 1.2:1 to 6 GHz</p> <p>Model No: <a href="#">PE91204</a></p>	PRICE		1-24	\$52.91	25-49	\$50.26	50-99	\$47.62	100+	\$45.50	 <table border="1"> <thead> <tr> <th colspan="2">PRICE</th> </tr> </thead> <tbody> <tr><td>1-24</td><td>\$46.90</td></tr> <tr><td>25-49</td><td>\$44.56</td></tr> <tr><td>50-99</td><td>\$42.21</td></tr> <tr><td>100+</td><td>\$40.33</td></tr> </tbody> </table> <p>TNC Female to TNC Female VSWR 1.3:1 to 6 GHz</p> <p>Model No: <a href="#">PE91241</a></p>	PRICE		1-24	\$46.90	25-49	\$44.56	50-99	\$42.21	100+	\$40.33	 <table border="1"> <thead> <tr> <th colspan="2">PRICE</th> </tr> </thead> <tbody> <tr><td>1-24</td><td>\$14.92</td></tr> <tr><td>25-49</td><td>\$14.17</td></tr> <tr><td>50-99</td><td>\$13.43</td></tr> <tr><td>100+</td><td>\$12.83</td></tr> </tbody> </table> <p>TNC Female to TNC Female VSWR 1.3:1 to 5 GHz</p> <p>Model No: <a href="#">PE9099</a></p>	PRICE		1-24	\$14.92	25-49	\$14.17	50-99	\$13.43	100+	\$12.83	 <table border="1"> <thead> <tr> <th colspan="2">PRICE</th> </tr> </thead> <tbody> <tr><td>1-24</td><td>\$53.66</td></tr> <tr><td>25-49</td><td>\$50.98</td></tr> <tr><td>50-99</td><td>\$48.29</td></tr> <tr><td>100+</td><td>\$46.15</td></tr> </tbody> </table> <p>Low PIM TNC Female to TNC Female VSWR 1.25:1 to 6 GHz</p> <p>Model No: <a href="#">PE91174</a></p>	PRICE		1-24	\$53.66	25-49	\$50.98	50-99	\$48.29	100+	\$46.15	 <table border="1"> <thead> <tr> <th colspan="2">PRICE</th> </tr> </thead> <tbody> <tr><td>1-9</td><td>\$124.73</td></tr> <tr><td>10-24</td><td>\$118.49</td></tr> <tr><td>25-49</td><td>\$112.26</td></tr> <tr><td>50+</td><td>\$107.27</td></tr> </tbody> </table> <p>PRECISION TNC Female to TNC Female VSWR 1.15:1 to 18 GHz</p> <p>Model No: <a href="#">PE9444</a></p>	PRICE		1-9	\$124.73	10-24	\$118.49	25-49	\$112.26	50+	\$107.27
PRICE																																																							
1-24	\$52.91																																																						
25-49	\$50.26																																																						
50-99	\$47.62																																																						
100+	\$45.50																																																						
PRICE																																																							
1-24	\$46.90																																																						
25-49	\$44.56																																																						
50-99	\$42.21																																																						
100+	\$40.33																																																						
PRICE																																																							
1-24	\$14.92																																																						
25-49	\$14.17																																																						
50-99	\$13.43																																																						
100+	\$12.83																																																						
PRICE																																																							
1-24	\$53.66																																																						
25-49	\$50.98																																																						
50-99	\$48.29																																																						
100+	\$46.15																																																						
PRICE																																																							
1-9	\$124.73																																																						
10-24	\$118.49																																																						
25-49	\$112.26																																																						
50+	\$107.27																																																						

# ADAPTERS

See Adapter Locator on Pages 8-13

See Page 369 for Mounting Holes

	A	B	C	D	E																																													
1	 <table border="1"> <thead> <tr><th>PRICE</th></tr> </thead> <tbody> <tr><td>1-24</td><td>\$35.68</td></tr> <tr><td>25-49</td><td>\$33.90</td></tr> <tr><td>50-99</td><td>\$32.11</td></tr> <tr><td>NEW 100+</td><td>\$30.68</td></tr> </tbody> </table> <p>TNC Female to TNC Female Tee</p> <p>Model No: <a href="#">PE91381</a></p>	PRICE	1-24	\$35.68	25-49	\$33.90	50-99	\$32.11	NEW 100+	\$30.68	 <table border="1"> <thead> <tr><th>PRICE</th></tr> </thead> <tbody> <tr><td>1-24</td><td>\$27.35</td></tr> <tr><td>25-49</td><td>\$25.98</td></tr> <tr><td>50-99</td><td>\$24.62</td></tr> <tr><td>100+</td><td>\$23.52</td></tr> </tbody> </table> <p>TNC Female to TNC Female Bulkhead VSWR 1.3:1 to 6 GHz</p> <p>Model No: <a href="#">PE9154</a></p>	PRICE	1-24	\$27.35	25-49	\$25.98	50-99	\$24.62	100+	\$23.52	 <table border="1"> <thead> <tr><th>PRICE</th></tr> </thead> <tbody> <tr><td>1-24</td><td>\$35.26</td></tr> <tr><td>25-49</td><td>\$33.50</td></tr> <tr><td>50-99</td><td>\$31.73</td></tr> <tr><td>100+</td><td>\$30.32</td></tr> </tbody> </table> <p>TNC Female to TNC Female 4 Hole Flange VSWR 1.3:1 to 11 GHz</p> <p>Model No: <a href="#">PE9288</a></p>	PRICE	1-24	\$35.26	25-49	\$33.50	50-99	\$31.73	100+	\$30.32	 <table border="1"> <thead> <tr><th>PRICE</th></tr> </thead> <tbody> <tr><td>1-24</td><td>\$52.51</td></tr> <tr><td>25-49</td><td>\$49.88</td></tr> <tr><td>50-99</td><td>\$47.26</td></tr> <tr><td>100+</td><td>\$45.16</td></tr> </tbody> </table> <p>TNC Female to TNC Female Bulkhead VSWR 1.2:1 to 6 GHz</p> <p>Model No: <a href="#">PE91205</a></p>	PRICE	1-24	\$52.51	25-49	\$49.88	50-99	\$47.26	100+	\$45.16	 <table border="1"> <thead> <tr><th>PRICE</th></tr> </thead> <tbody> <tr><td>1-24</td><td>\$64.16</td></tr> <tr><td>25-49</td><td>\$60.95</td></tr> <tr><td>50-99</td><td>\$57.74</td></tr> <tr><td>100+</td><td>\$55.18</td></tr> </tbody> </table> <p>TNC Female to TNC Female Bulkhead VSWR 1.3:1 to 6 GHz</p> <p>Model No: <a href="#">PE91242</a></p>	PRICE	1-24	\$64.16	25-49	\$60.95	50-99	\$57.74	100+	\$55.18
	PRICE																																																	
1-24	\$35.68																																																	
25-49	\$33.90																																																	
50-99	\$32.11																																																	
NEW 100+	\$30.68																																																	
PRICE																																																		
1-24	\$27.35																																																	
25-49	\$25.98																																																	
50-99	\$24.62																																																	
100+	\$23.52																																																	
PRICE																																																		
1-24	\$35.26																																																	
25-49	\$33.50																																																	
50-99	\$31.73																																																	
100+	\$30.32																																																	
PRICE																																																		
1-24	\$52.51																																																	
25-49	\$49.88																																																	
50-99	\$47.26																																																	
100+	\$45.16																																																	
PRICE																																																		
1-24	\$64.16																																																	
25-49	\$60.95																																																	
50-99	\$57.74																																																	
100+	\$55.18																																																	
2	 <table border="1"> <thead> <tr><th>PRICE</th></tr> </thead> <tbody> <tr><td>1-24</td><td>\$30.68</td></tr> <tr><td>25-49</td><td>\$29.15</td></tr> <tr><td>50-99</td><td>\$27.61</td></tr> <tr><td>100+</td><td>\$26.38</td></tr> </tbody> </table> <p>TNC Female to TNC Female Bulkhead Max. Freq. 11 GHz</p> <p>Model No: <a href="#">PE9287</a></p>	PRICE	1-24	\$30.68	25-49	\$29.15	50-99	\$27.61	100+	\$26.38	<p><b>Reverse Polarity TNC In-Series</b></p> 		 <table border="1"> <thead> <tr><th>PRICE</th></tr> </thead> <tbody> <tr><td>1-24</td><td>\$41.39</td></tr> <tr><td>25-49</td><td>\$39.32</td></tr> <tr><td>50-99</td><td>\$37.25</td></tr> <tr><td>100+</td><td>\$35.60</td></tr> </tbody> </table> <p>TNC Male to Rev. Pol. TNC Female</p> <p>Model No: <a href="#">PE9532</a></p>	PRICE	1-24	\$41.39	25-49	\$39.32	50-99	\$37.25	100+	\$35.60	 <table border="1"> <thead> <tr><th>PRICE</th></tr> </thead> <tbody> <tr><td>1-24</td><td>\$40.00</td></tr> <tr><td>25-49</td><td>\$38.00</td></tr> <tr><td>50-99</td><td>\$36.00</td></tr> <tr><td>100+</td><td>\$34.40</td></tr> </tbody> </table> <p>TNC Female to Rev. Pol. TNC Male VSWR 1.32:1 to 6 GHz</p> <p>Model No: <a href="#">PE9531</a></p>	PRICE	1-24	\$40.00	25-49	\$38.00	50-99	\$36.00	100+	\$34.40	 <table border="1"> <thead> <tr><th>PRICE</th></tr> </thead> <tbody> <tr><td>1-24</td><td>\$33.78</td></tr> <tr><td>25-49</td><td>\$32.09</td></tr> <tr><td>50-99</td><td>\$30.40</td></tr> <tr><td>100+</td><td>\$29.05</td></tr> </tbody> </table> <p>Rev. Pol. TNC Male to Rev. Pol. TNC Female VSWR 1.25:1 to 6 GHz</p> <p>Model No: <a href="#">PE9918</a></p>	PRICE	1-24	\$33.78	25-49	\$32.09	50-99	\$30.40	100+	\$29.05								
	PRICE																																																	
1-24	\$30.68																																																	
25-49	\$29.15																																																	
50-99	\$27.61																																																	
100+	\$26.38																																																	
PRICE																																																		
1-24	\$41.39																																																	
25-49	\$39.32																																																	
50-99	\$37.25																																																	
100+	\$35.60																																																	
PRICE																																																		
1-24	\$40.00																																																	
25-49	\$38.00																																																	
50-99	\$36.00																																																	
100+	\$34.40																																																	
PRICE																																																		
1-24	\$33.78																																																	
25-49	\$32.09																																																	
50-99	\$30.40																																																	
100+	\$29.05																																																	
3	<p><b>TNC Between Series</b></p> 		 <table border="1"> <thead> <tr><th>PRICE</th></tr> </thead> <tbody> <tr><td>1-4</td><td>\$700.87</td></tr> <tr><td>5-9</td><td>\$665.83</td></tr> <tr><td>10-24</td><td>\$630.78</td></tr> <tr><td>PRECISION 25+</td><td>\$602.75</td></tr> </tbody> </table> <p>TNC Male to 7mm Sexless VSWR 1.15:1 to 18 GHz</p> <p>Model No: <a href="#">PE9219</a></p>	PRICE	1-4	\$700.87	5-9	\$665.83	10-24	\$630.78	PRECISION 25+	\$602.75	 <table border="1"> <thead> <tr><th>PRICE</th></tr> </thead> <tbody> <tr><td>1-9</td><td>\$253.83</td></tr> <tr><td>10-24</td><td>\$241.14</td></tr> <tr><td>25-49</td><td>\$228.45</td></tr> <tr><td>50+</td><td>\$218.29</td></tr> </tbody> </table> <p>TNC Male to 7/16 DIN Female VSWR 1.35:1 to 7.5 GHz</p> <p>Model No: <a href="#">PE9638</a></p>	PRICE	1-9	\$253.83	10-24	\$241.14	25-49	\$228.45	50+	\$218.29	 <table border="1"> <thead> <tr><th>PRICE</th></tr> </thead> <tbody> <tr><td>1-24</td><td>\$19.63</td></tr> <tr><td>25-49</td><td>\$18.65</td></tr> <tr><td>50-99</td><td>\$17.67</td></tr> <tr><td>100+</td><td>\$16.88</td></tr> </tbody> </table> <p>TNC Male to BNC Female VSWR 1.5:1 to 2 GHz</p> <p>Model No: <a href="#">PE9088</a></p>	PRICE	1-24	\$19.63	25-49	\$18.65	50-99	\$17.67	100+	\$16.88	 <table border="1"> <thead> <tr><th>PRICE</th></tr> </thead> <tbody> <tr><td>1-24</td><td>\$67.33</td></tr> <tr><td>25-49</td><td>\$63.96</td></tr> <tr><td>50-99</td><td>\$60.60</td></tr> <tr><td>100+</td><td>\$57.90</td></tr> </tbody> </table> <p>TNC Male to BNC Female Right Angle</p> <p>Model No: <a href="#">PE9783</a></p>	PRICE	1-24	\$67.33	25-49	\$63.96	50-99	\$60.60	100+	\$57.90								
	PRICE																																																	
1-4	\$700.87																																																	
5-9	\$665.83																																																	
10-24	\$630.78																																																	
PRECISION 25+	\$602.75																																																	
PRICE																																																		
1-9	\$253.83																																																	
10-24	\$241.14																																																	
25-49	\$228.45																																																	
50+	\$218.29																																																	
PRICE																																																		
1-24	\$19.63																																																	
25-49	\$18.65																																																	
50-99	\$17.67																																																	
100+	\$16.88																																																	
PRICE																																																		
1-24	\$67.33																																																	
25-49	\$63.96																																																	
50-99	\$60.60																																																	
100+	\$57.90																																																	
4	 <table border="1"> <thead> <tr><th>PRICE</th></tr> </thead> <tbody> <tr><td>1-24</td><td>\$115.97</td></tr> <tr><td>25-49</td><td>\$110.17</td></tr> <tr><td>50-99</td><td>\$104.37</td></tr> <tr><td>100+</td><td>\$99.73</td></tr> </tbody> </table> <p>TNC Male to C Female</p> <p>Model No: <a href="#">PE9562</a></p>	PRICE	1-24	\$115.97	25-49	\$110.17	50-99	\$104.37	100+	\$99.73	 <table border="1"> <thead> <tr><th>PRICE</th></tr> </thead> <tbody> <tr><td>1-24</td><td>\$20.43</td></tr> <tr><td>25-49</td><td>\$19.41</td></tr> <tr><td>50-99</td><td>\$18.39</td></tr> <tr><td>100+</td><td>\$17.57</td></tr> </tbody> </table> <p>TNC Male to FME Plug</p> <p>Model No: <a href="#">PE9699</a></p>	PRICE	1-24	\$20.43	25-49	\$19.41	50-99	\$18.39	100+	\$17.57	 <table border="1"> <thead> <tr><th>PRICE</th></tr> </thead> <tbody> <tr><td>1-24</td><td>\$11.83</td></tr> <tr><td>25-49</td><td>\$11.24</td></tr> <tr><td>50-99</td><td>\$10.65</td></tr> <tr><td>100+</td><td>\$10.17</td></tr> </tbody> </table> <p>TNC Male to FME Plug Right Angle</p> <p>Model No: <a href="#">PE9700</a></p>	PRICE	1-24	\$11.83	25-49	\$11.24	50-99	\$10.65	100+	\$10.17	 <table border="1"> <thead> <tr><th>PRICE</th></tr> </thead> <tbody> <tr><td>1-24</td><td>\$17.58</td></tr> <tr><td>25-49</td><td>\$16.70</td></tr> <tr><td>50-99</td><td>\$15.82</td></tr> <tr><td>100+</td><td>\$15.12</td></tr> </tbody> </table> <p>TNC Male to FME Jack</p> <p>Model No: <a href="#">PE9713</a></p>	PRICE	1-24	\$17.58	25-49	\$16.70	50-99	\$15.82	100+	\$15.12	 <table border="1"> <thead> <tr><th>PRICE</th></tr> </thead> <tbody> <tr><td>1-24</td><td>\$87.50</td></tr> <tr><td>25-49</td><td>\$83.13</td></tr> <tr><td>50-99</td><td>\$78.75</td></tr> <tr><td>100+</td><td>\$75.25</td></tr> </tbody> </table> <p>TNC Male to HN Male</p> <p>Model No: <a href="#">PE9563</a></p>	PRICE	1-24	\$87.50	25-49	\$83.13	50-99	\$78.75	100+	\$75.25
	PRICE																																																	
1-24	\$115.97																																																	
25-49	\$110.17																																																	
50-99	\$104.37																																																	
100+	\$99.73																																																	
PRICE																																																		
1-24	\$20.43																																																	
25-49	\$19.41																																																	
50-99	\$18.39																																																	
100+	\$17.57																																																	
PRICE																																																		
1-24	\$11.83																																																	
25-49	\$11.24																																																	
50-99	\$10.65																																																	
100+	\$10.17																																																	
PRICE																																																		
1-24	\$17.58																																																	
25-49	\$16.70																																																	
50-99	\$15.82																																																	
100+	\$15.12																																																	
PRICE																																																		
1-24	\$87.50																																																	
25-49	\$83.13																																																	
50-99	\$78.75																																																	
100+	\$75.25																																																	
5	 <table border="1"> <thead> <tr><th>PRICE</th></tr> </thead> <tbody> <tr><td>1-24</td><td>\$71.38</td></tr> <tr><td>25-49</td><td>\$67.81</td></tr> <tr><td>50-99</td><td>\$64.24</td></tr> <tr><td>100+</td><td>\$61.39</td></tr> </tbody> </table> <p>TNC Male to MCX Plug</p> <p>Model No: <a href="#">PE9543</a></p>	PRICE	1-24	\$71.38	25-49	\$67.81	50-99	\$64.24	100+	\$61.39	 <table border="1"> <thead> <tr><th>PRICE</th></tr> </thead> <tbody> <tr><td>1-24</td><td>\$77.53</td></tr> <tr><td>25-49</td><td>\$73.65</td></tr> <tr><td>50-99</td><td>\$69.78</td></tr> <tr><td>100+</td><td>\$66.68</td></tr> </tbody> </table> <p>TNC Male to MCX Jack</p> <p>Model No: <a href="#">PE9542</a></p>	PRICE	1-24	\$77.53	25-49	\$73.65	50-99	\$69.78	100+	\$66.68	 <table border="1"> <thead> <tr><th>PRICE</th></tr> </thead> <tbody> <tr><td>1-24</td><td>\$22.00</td></tr> <tr><td>25-49</td><td>\$20.90</td></tr> <tr><td>50-99</td><td>\$19.80</td></tr> <tr><td>100+</td><td>\$18.92</td></tr> </tbody> </table> <p>TNC Male to Mini UHF Female</p> <p>Model No: <a href="#">PE9345</a></p>	PRICE	1-24	\$22.00	25-49	\$20.90	50-99	\$19.80	100+	\$18.92	 <table border="1"> <thead> <tr><th>PRICE</th></tr> </thead> <tbody> <tr><td>1-24</td><td>\$64.89</td></tr> <tr><td>25-49</td><td>\$61.65</td></tr> <tr><td>50-99</td><td>\$58.40</td></tr> <tr><td>100+</td><td>\$55.81</td></tr> </tbody> </table> <p>TNC Male to SMC Jack</p> <p>Model No: <a href="#">PE9226</a></p>	PRICE	1-24	\$64.89	25-49	\$61.65	50-99	\$58.40	100+	\$55.81	 <table border="1"> <thead> <tr><th>PRICE</th></tr> </thead> <tbody> <tr><td>1-24</td><td>\$27.46</td></tr> <tr><td>25-49</td><td>\$26.09</td></tr> <tr><td>50-99</td><td>\$24.71</td></tr> <tr><td>100+</td><td>\$23.62</td></tr> </tbody> </table> <p>TNC Male to UHF Female Max. Freq. 300 MHz</p> <p>Model No: <a href="#">PE9291</a></p>	PRICE	1-24	\$27.46	25-49	\$26.09	50-99	\$24.71	100+	\$23.62
	PRICE																																																	
1-24	\$71.38																																																	
25-49	\$67.81																																																	
50-99	\$64.24																																																	
100+	\$61.39																																																	
PRICE																																																		
1-24	\$77.53																																																	
25-49	\$73.65																																																	
50-99	\$69.78																																																	
100+	\$66.68																																																	
PRICE																																																		
1-24	\$22.00																																																	
25-49	\$20.90																																																	
50-99	\$19.80																																																	
100+	\$18.92																																																	
PRICE																																																		
1-24	\$64.89																																																	
25-49	\$61.65																																																	
50-99	\$58.40																																																	
100+	\$55.81																																																	
PRICE																																																		
1-24	\$27.46																																																	
25-49	\$26.09																																																	
50-99	\$24.71																																																	
100+	\$23.62																																																	
6	 <table border="1"> <thead> <tr><th>PRICE</th></tr> </thead> <tbody> <tr><td>1-9</td><td>\$578.53</td></tr> <tr><td>10-24</td><td>\$549.60</td></tr> <tr><td>25-49</td><td>\$520.68</td></tr> <tr><td>PRECISION 50+</td><td>\$497.54</td></tr> </tbody> </table> <p>TNC Female to 7mm Sexless VSWR 1.15:1 to 18 GHz</p> <p>Model No: <a href="#">PE9218</a></p>	PRICE	1-9	\$578.53	10-24	\$549.60	25-49	\$520.68	PRECISION 50+	\$497.54	 <table border="1"> <thead> <tr><th>PRICE</th></tr> </thead> <tbody> <tr><td>1-9</td><td>\$269.07</td></tr> <tr><td>10-24</td><td>\$255.62</td></tr> <tr><td>25-49</td><td>\$242.16</td></tr> <tr><td>50+</td><td>\$231.40</td></tr> </tbody> </table> <p>TNC Female to 7/16 DIN Female Max. Freq. 7.5 GHz</p> <p>Model No: <a href="#">PE91392</a></p>	PRICE	1-9	\$269.07	10-24	\$255.62	25-49	\$242.16	50+	\$231.40	 <table border="1"> <thead> <tr><th>PRICE</th></tr> </thead> <tbody> <tr><td>1-24</td><td>\$28.96</td></tr> <tr><td>25-49</td><td>\$27.51</td></tr> <tr><td>50-99</td><td>\$26.06</td></tr> <tr><td>100+</td><td>\$24.91</td></tr> </tbody> </table> <p>TNC Female to BNC Male VSWR 1.3:1 to 4 GHz</p> <p>Model No: <a href="#">PE9098</a></p>	PRICE	1-24	\$28.96	25-49	\$27.51	50-99	\$26.06	100+	\$24.91	 <table border="1"> <thead> <tr><th>PRICE</th></tr> </thead> <tbody> <tr><td>1-24</td><td>\$36.22</td></tr> <tr><td>25-49</td><td>\$34.41</td></tr> <tr><td>50-99</td><td>\$32.60</td></tr> <tr><td>100+</td><td>\$31.15</td></tr> </tbody> </table> <p>TNC Female to BNC Female VSWR 1.3:1 to 4 GHz</p> <p>Model No: <a href="#">PE9097</a></p>	PRICE	1-24	\$36.22	25-49	\$34.41	50-99	\$32.60	100+	\$31.15	 <table border="1"> <thead> <tr><th>PRICE</th></tr> </thead> <tbody> <tr><td>1-9</td><td>\$134.92</td></tr> <tr><td>10-24</td><td>\$128.17</td></tr> <tr><td>25-49</td><td>\$121.43</td></tr> <tr><td>50+</td><td>\$116.03</td></tr> </tbody> </table> <p>TNC Female to C Male</p> <p>Model No: <a href="#">PE9564</a></p>	PRICE	1-9	\$134.92	10-24	\$128.17	25-49	\$121.43	50+	\$116.03
	PRICE																																																	
1-9	\$578.53																																																	
10-24	\$549.60																																																	
25-49	\$520.68																																																	
PRECISION 50+	\$497.54																																																	
PRICE																																																		
1-9	\$269.07																																																	
10-24	\$255.62																																																	
25-49	\$242.16																																																	
50+	\$231.40																																																	
PRICE																																																		
1-24	\$28.96																																																	
25-49	\$27.51																																																	
50-99	\$26.06																																																	
100+	\$24.91																																																	
PRICE																																																		
1-24	\$36.22																																																	
25-49	\$34.41																																																	
50-99	\$32.60																																																	
100+	\$31.15																																																	
PRICE																																																		
1-9	\$134.92																																																	
10-24	\$128.17																																																	
25-49	\$121.43																																																	
50+	\$116.03																																																	
7	 <table border="1"> <thead> <tr><th>PRICE</th></tr> </thead> <tbody> <tr><td>1-24</td><td>\$5.28</td></tr> <tr><td>25-49</td><td>\$5.02</td></tr> <tr><td>50-99</td><td>\$4.75</td></tr> <tr><td>100+</td><td>\$4.54</td></tr> </tbody> </table> <p>TNC Female to FME Jack</p> <p>Model No: <a href="#">PE9714</a></p>	PRICE	1-24	\$5.28	25-49	\$5.02	50-99	\$4.75	100+	\$4.54	 <table border="1"> <thead> <tr><th>PRICE</th></tr> </thead> <tbody> <tr><td>1-24</td><td>\$76.40</td></tr> <tr><td>25-49</td><td>\$72.58</td></tr> <tr><td>50-99</td><td>\$68.76</td></tr> <tr><td>100+</td><td>\$65.70</td></tr> </tbody> </table> <p>TNC Female to MCX Plug</p> <p>Model No: <a href="#">PE9545</a></p>	PRICE	1-24	\$76.40	25-49	\$72.58	50-99	\$68.76	100+	\$65.70	 <table border="1"> <thead> <tr><th>PRICE</th></tr> </thead> <tbody> <tr><td>1-24</td><td>\$80.84</td></tr> <tr><td>25-49</td><td>\$76.80</td></tr> <tr><td>50-99</td><td>\$72.76</td></tr> <tr><td>100+</td><td>\$69.52</td></tr> </tbody> </table> <p>TNC Female to MCX Jack</p> <p>Model No: <a href="#">PE9544</a></p>	PRICE	1-24	\$80.84	25-49	\$76.80	50-99	\$72.76	100+	\$69.52	 <table border="1"> <thead> <tr><th>PRICE</th></tr> </thead> <tbody> <tr><td>1-24</td><td>\$93.75</td></tr> <tr><td>25-49</td><td>\$89.06</td></tr> <tr><td>50-99</td><td>\$84.38</td></tr> <tr><td>100+</td><td>\$80.63</td></tr> </tbody> </table> <p>TNC Female to MCX Jack Bulkhead-Mounting Hole B04</p> <p>Model No: <a href="#">PE9521</a></p>	PRICE	1-24	\$93.75	25-49	\$89.06	50-99	\$84.38	100+	\$80.63	 <table border="1"> <thead> <tr><th>PRICE</th></tr> </thead> <tbody> <tr><td>1-24</td><td>\$19.96</td></tr> <tr><td>25-49</td><td>\$18.96</td></tr> <tr><td>50-99</td><td>\$17.96</td></tr> <tr><td>100+</td><td>\$17.17</td></tr> </tbody> </table> <p>TNC Female to Mini UHF Male Max. Freq. 2.5 GHz</p> <p>Model No: <a href="#">PE9346</a></p>	PRICE	1-24	\$19.96	25-49	\$18.96	50-99	\$17.96	100+	\$17.17
	PRICE																																																	
1-24	\$5.28																																																	
25-49	\$5.02																																																	
50-99	\$4.75																																																	
100+	\$4.54																																																	
PRICE																																																		
1-24	\$76.40																																																	
25-49	\$72.58																																																	
50-99	\$68.76																																																	
100+	\$65.70																																																	
PRICE																																																		
1-24	\$80.84																																																	
25-49	\$76.80																																																	
50-99	\$72.76																																																	
100+	\$69.52																																																	
PRICE																																																		
1-24	\$93.75																																																	
25-49	\$89.06																																																	
50-99	\$84.38																																																	
100+	\$80.63																																																	
PRICE																																																		
1-24	\$19.96																																																	
25-49	\$18.96																																																	
50-99	\$17.96																																																	
100+	\$17.17																																																	



Technical Support  
+1 (949) 261-1920



Same-Day Shipping,  
Even Custom Cable Assemblies

# ADAPTERS

See Adapter Locator on Pages 8-13

See Page 369 for Mounting Holes

Adapters

See Our Website For Current Pricing & Real-Time Stock Availability!

	A	B	C	D	E																																																		
1	 <table border="1"> <thead> <tr> <th colspan="2">PRICE</th> </tr> </thead> <tbody> <tr> <td>1-9</td> <td>\$212.18</td> </tr> <tr> <td>10-24</td> <td>\$201.57</td> </tr> <tr> <td>25-49</td> <td>\$190.96</td> </tr> <tr> <td>50+</td> <td>\$182.47</td> </tr> </tbody> </table> <p>TNC Female to Limited Detent SMP Male Bulkhead VSWR 1.3:1 to 8 GHz</p> <p>Model No: <a href="#">PE91073</a></p>	PRICE		1-9	\$212.18	10-24	\$201.57	25-49	\$190.96	50+	\$182.47	 <table border="1"> <thead> <tr> <th colspan="2">PRICE</th> </tr> </thead> <tbody> <tr> <td>1-24</td> <td>\$35.95</td> </tr> <tr> <td>25-49</td> <td>\$34.15</td> </tr> <tr> <td>50-99</td> <td>\$32.36</td> </tr> <tr> <td>100+</td> <td>\$30.92</td> </tr> </tbody> </table> <p>TNC Female to UHF Male VSWR 1.3:1 to 300 MHz</p> <p>Model No: <a href="#">PE9372</a></p>	PRICE		1-24	\$35.95	25-49	\$34.15	50-99	\$32.36	100+	\$30.92	<p style="text-align: center;"><b>Reverse Polarity TNC Between Series</b></p> <p style="text-align: center;">→</p>	 <table border="1"> <thead> <tr> <th colspan="2">PRICE</th> </tr> </thead> <tbody> <tr> <td>1-24</td> <td>\$36.21</td> </tr> <tr> <td>25-49</td> <td>\$34.40</td> </tr> <tr> <td>50-99</td> <td>\$32.59</td> </tr> <tr> <td>100+</td> <td>\$31.14</td> </tr> </tbody> </table> <p>Rev. Pol. TNC Female to BNC Male Max. Freq. 4 GHz</p> <p>Model No: <a href="#">PE91087</a></p>	PRICE		1-24	\$36.21	25-49	\$34.40	50-99	\$32.59	100+	\$31.14	<p style="text-align: center;"><b>UHF In-Series</b></p> <p style="text-align: center;">→</p>																				
PRICE																																																							
1-9	\$212.18																																																						
10-24	\$201.57																																																						
25-49	\$190.96																																																						
50+	\$182.47																																																						
PRICE																																																							
1-24	\$35.95																																																						
25-49	\$34.15																																																						
50-99	\$32.36																																																						
100+	\$30.92																																																						
PRICE																																																							
1-24	\$36.21																																																						
25-49	\$34.40																																																						
50-99	\$32.59																																																						
100+	\$31.14																																																						
2	 <table border="1"> <thead> <tr> <th colspan="2">PRICE</th> </tr> </thead> <tbody> <tr> <td>1-24</td> <td>\$20.01</td> </tr> <tr> <td>25-49</td> <td>\$19.01</td> </tr> <tr> <td>50-99</td> <td>\$18.01</td> </tr> <tr> <td>NEW 100+</td> <td>\$17.21</td> </tr> </tbody> </table> <p>UHF Male to UHF Male VSWR 1.3:1 to 300 MHz</p> <p>Model No: <a href="#">PE91487</a></p>	PRICE		1-24	\$20.01	25-49	\$19.01	50-99	\$18.01	NEW 100+	\$17.21	 <table border="1"> <thead> <tr> <th colspan="2">PRICE</th> </tr> </thead> <tbody> <tr> <td>1-24</td> <td>\$30.87</td> </tr> <tr> <td>25-49</td> <td>\$29.33</td> </tr> <tr> <td>50-99</td> <td>\$27.78</td> </tr> <tr> <td>100+</td> <td>\$26.55</td> </tr> </tbody> </table> <p>UHF Male to UHF Female Right Angle Max. Freq. 300 MHz</p> <p>Model No: <a href="#">PE9209</a></p>	PRICE		1-24	\$30.87	25-49	\$29.33	50-99	\$27.78	100+	\$26.55	 <table border="1"> <thead> <tr> <th colspan="2">PRICE</th> </tr> </thead> <tbody> <tr> <td>1-24</td> <td>\$25.72</td> </tr> <tr> <td>25-49</td> <td>\$24.43</td> </tr> <tr> <td>50-99</td> <td>\$23.15</td> </tr> <tr> <td>100+</td> <td>\$22.12</td> </tr> </tbody> </table> <p>UHF Female to UHF Male Tee</p> <p>Model No: <a href="#">PE9095</a></p>	PRICE		1-24	\$25.72	25-49	\$24.43	50-99	\$23.15	100+	\$22.12	 <table border="1"> <thead> <tr> <th colspan="2">PRICE</th> </tr> </thead> <tbody> <tr> <td>1-24</td> <td>\$20.72</td> </tr> <tr> <td>25-49</td> <td>\$19.68</td> </tr> <tr> <td>50-99</td> <td>\$18.65</td> </tr> <tr> <td>100+</td> <td>\$17.82</td> </tr> </tbody> </table> <p>UHF Female to UHF Female VSWR 1.3:1 to 300 MHz</p> <p>Model No: <a href="#">PE9094</a></p>	PRICE		1-24	\$20.72	25-49	\$19.68	50-99	\$18.65	100+	\$17.82	 <table border="1"> <thead> <tr> <th colspan="2">PRICE</th> </tr> </thead> <tbody> <tr> <td>1-24</td> <td>\$47.31</td> </tr> <tr> <td>25-49</td> <td>\$44.94</td> </tr> <tr> <td>50-99</td> <td>\$42.58</td> </tr> <tr> <td>100+</td> <td>\$40.69</td> </tr> </tbody> </table> <p>UHF Female to UHF Female Bulkhead-Mounting Hole F03 Max. Freq. 300 MHz</p> <p>Model No: <a href="#">PE9114</a></p>	PRICE		1-24	\$47.31	25-49	\$44.94	50-99	\$42.58	100+	\$40.69
PRICE																																																							
1-24	\$20.01																																																						
25-49	\$19.01																																																						
50-99	\$18.01																																																						
NEW 100+	\$17.21																																																						
PRICE																																																							
1-24	\$30.87																																																						
25-49	\$29.33																																																						
50-99	\$27.78																																																						
100+	\$26.55																																																						
PRICE																																																							
1-24	\$25.72																																																						
25-49	\$24.43																																																						
50-99	\$23.15																																																						
100+	\$22.12																																																						
PRICE																																																							
1-24	\$20.72																																																						
25-49	\$19.68																																																						
50-99	\$18.65																																																						
100+	\$17.82																																																						
PRICE																																																							
1-24	\$47.31																																																						
25-49	\$44.94																																																						
50-99	\$42.58																																																						
100+	\$40.69																																																						
3	<p style="text-align: center;"><b>UHF Between Series</b></p> <p style="text-align: center;">→</p>	 <table border="1"> <thead> <tr> <th colspan="2">PRICE</th> </tr> </thead> <tbody> <tr> <td>1-24</td> <td>\$27.86</td> </tr> <tr> <td>25-49</td> <td>\$26.47</td> </tr> <tr> <td>50-99</td> <td>\$25.07</td> </tr> <tr> <td>100+</td> <td>\$23.96</td> </tr> </tbody> </table> <p>UHF Male to BNC Male</p> <p>Model No: <a href="#">PE9201</a></p>	PRICE		1-24	\$27.86	25-49	\$26.47	50-99	\$25.07	100+	\$23.96	 <table border="1"> <thead> <tr> <th colspan="2">PRICE</th> </tr> </thead> <tbody> <tr> <td>1-24</td> <td>\$13.53</td> </tr> <tr> <td>25-49</td> <td>\$12.85</td> </tr> <tr> <td>50-99</td> <td>\$12.18</td> </tr> <tr> <td>100+</td> <td>\$11.64</td> </tr> </tbody> </table> <p>UHF Male to BNC Female VSWR 1.3:1 to 300 MHz</p> <p>Model No: <a href="#">PE91328</a></p>	PRICE		1-24	\$13.53	25-49	\$12.85	50-99	\$12.18	100+	\$11.64	 <table border="1"> <thead> <tr> <th colspan="2">PRICE</th> </tr> </thead> <tbody> <tr> <td>1-24</td> <td>\$36.50</td> </tr> <tr> <td>25-49</td> <td>\$34.68</td> </tr> <tr> <td>50-99</td> <td>\$32.85</td> </tr> <tr> <td>100+</td> <td>\$31.39</td> </tr> </tbody> </table> <p>UHF Male to 75 Ohm F Female</p> <p>Model No: <a href="#">PE9165</a></p>	PRICE		1-24	\$36.50	25-49	\$34.68	50-99	\$32.85	100+	\$31.39	 <table border="1"> <thead> <tr> <th colspan="2">PRICE</th> </tr> </thead> <tbody> <tr> <td>1-24</td> <td>\$19.46</td> </tr> <tr> <td>25-49</td> <td>\$18.49</td> </tr> <tr> <td>50-99</td> <td>\$17.51</td> </tr> <tr> <td>100+</td> <td>\$16.74</td> </tr> </tbody> </table> <p>UHF Male to FME Plug</p> <p>Model No: <a href="#">PE9701</a></p>	PRICE		1-24	\$19.46	25-49	\$18.49	50-99	\$17.51	100+	\$16.74										
PRICE																																																							
1-24	\$27.86																																																						
25-49	\$26.47																																																						
50-99	\$25.07																																																						
100+	\$23.96																																																						
PRICE																																																							
1-24	\$13.53																																																						
25-49	\$12.85																																																						
50-99	\$12.18																																																						
100+	\$11.64																																																						
PRICE																																																							
1-24	\$36.50																																																						
25-49	\$34.68																																																						
50-99	\$32.85																																																						
100+	\$31.39																																																						
PRICE																																																							
1-24	\$19.46																																																						
25-49	\$18.49																																																						
50-99	\$17.51																																																						
100+	\$16.74																																																						
4	 <table border="1"> <thead> <tr> <th colspan="2">PRICE</th> </tr> </thead> <tbody> <tr> <td>1-24</td> <td>\$20.72</td> </tr> <tr> <td>25-49</td> <td>\$19.68</td> </tr> <tr> <td>50-99</td> <td>\$18.65</td> </tr> <tr> <td>100+</td> <td>\$17.82</td> </tr> </tbody> </table> <p>UHF Male to Mini UHF Female</p> <p>Model No: <a href="#">PE9348</a></p>	PRICE		1-24	\$20.72	25-49	\$19.68	50-99	\$18.65	100+	\$17.82	 <table border="1"> <thead> <tr> <th colspan="2">PRICE</th> </tr> </thead> <tbody> <tr> <td>1-24</td> <td>\$16.56</td> </tr> <tr> <td>25-49</td> <td>\$15.73</td> </tr> <tr> <td>50-99</td> <td>\$14.90</td> </tr> <tr> <td>100+</td> <td>\$14.24</td> </tr> </tbody> </table> <p>UHF Female to BNC Male VSWR 1.3:1 to 300 MHz</p> <p>Model No: <a href="#">PE91329</a></p>	PRICE		1-24	\$16.56	25-49	\$15.73	50-99	\$14.90	100+	\$14.24	 <table border="1"> <thead> <tr> <th colspan="2">PRICE</th> </tr> </thead> <tbody> <tr> <td>1-24</td> <td>\$25.72</td> </tr> <tr> <td>25-49</td> <td>\$24.43</td> </tr> <tr> <td>50-99</td> <td>\$23.15</td> </tr> <tr> <td>100+</td> <td>\$22.12</td> </tr> </tbody> </table> <p>UHF Female to BNC Female</p> <p>Model No: <a href="#">PE9421</a></p>	PRICE		1-24	\$25.72	25-49	\$24.43	50-99	\$23.15	100+	\$22.12	 <table border="1"> <thead> <tr> <th colspan="2">PRICE</th> </tr> </thead> <tbody> <tr> <td>1-24</td> <td>\$32.99</td> </tr> <tr> <td>25-49</td> <td>\$31.34</td> </tr> <tr> <td>50-99</td> <td>\$29.69</td> </tr> <tr> <td>100+</td> <td>\$28.37</td> </tr> </tbody> </table> <p>UHF Female to 75 Ohm F Female</p> <p>Model No: <a href="#">PE9167</a></p>	PRICE		1-24	\$32.99	25-49	\$31.34	50-99	\$29.69	100+	\$28.37	 <table border="1"> <thead> <tr> <th colspan="2">PRICE</th> </tr> </thead> <tbody> <tr> <td>1-24</td> <td>\$14.83</td> </tr> <tr> <td>25-49</td> <td>\$14.09</td> </tr> <tr> <td>50-99</td> <td>\$13.35</td> </tr> <tr> <td>NEW 100+</td> <td>\$12.75</td> </tr> </tbody> </table> <p>UHF Female to Mini UHF Male VSWR 1.3:1 to 300 MHz</p> <p>Model No: <a href="#">PE91447</a></p>	PRICE		1-24	\$14.83	25-49	\$14.09	50-99	\$13.35	NEW 100+	\$12.75
PRICE																																																							
1-24	\$20.72																																																						
25-49	\$19.68																																																						
50-99	\$18.65																																																						
100+	\$17.82																																																						
PRICE																																																							
1-24	\$16.56																																																						
25-49	\$15.73																																																						
50-99	\$14.90																																																						
100+	\$14.24																																																						
PRICE																																																							
1-24	\$25.72																																																						
25-49	\$24.43																																																						
50-99	\$23.15																																																						
100+	\$22.12																																																						
PRICE																																																							
1-24	\$32.99																																																						
25-49	\$31.34																																																						
50-99	\$29.69																																																						
100+	\$28.37																																																						
PRICE																																																							
1-24	\$14.83																																																						
25-49	\$14.09																																																						
50-99	\$13.35																																																						
NEW 100+	\$12.75																																																						
5	<p style="text-align: center;"><b>2.92mm NMD Between Series</b></p> <p style="text-align: center;">→</p>	 <table border="1"> <thead> <tr> <th colspan="2">PRICE</th> </tr> </thead> <tbody> <tr> <td>1-9</td> <td>\$334.04</td> </tr> <tr> <td>10-24</td> <td>\$317.34</td> </tr> <tr> <td>25-49</td> <td>\$300.64</td> </tr> <tr> <td>50+</td> <td>\$287.27</td> </tr> </tbody> </table> <p>2.92mm NMD Female to 2.4mm Female VSWR 1.35:1 to 40 GHz</p> <p>Model No: <a href="#">PE91144</a></p>	PRICE		1-9	\$334.04	10-24	\$317.34	25-49	\$300.64	50+	\$287.27	<p style="text-align: center;"><b>75 Ohm BNC In-Series</b></p> <p style="text-align: center;">→</p>	 <table border="1"> <thead> <tr> <th colspan="2">PRICE</th> </tr> </thead> <tbody> <tr> <td>1-24</td> <td>\$28.28</td> </tr> <tr> <td>25-49</td> <td>\$26.87</td> </tr> <tr> <td>50-99</td> <td>\$25.45</td> </tr> <tr> <td>100+</td> <td>\$24.32</td> </tr> </tbody> </table> <p>75 Ohm BNC Male to 75 Ohm BNC Male VSWR 1.5:1 to 300 MHz</p> <p>Model No: <a href="#">PE9364</a></p>	PRICE		1-24	\$28.28	25-49	\$26.87	50-99	\$25.45	100+	\$24.32	 <table border="1"> <thead> <tr> <th colspan="2">PRICE</th> </tr> </thead> <tbody> <tr> <td>1-24</td> <td>\$40.26</td> </tr> <tr> <td>25-49</td> <td>\$38.25</td> </tr> <tr> <td>50-99</td> <td>\$36.23</td> </tr> <tr> <td>100+</td> <td>\$34.62</td> </tr> </tbody> </table> <p>75 Ohm BNC Male to 75 Ohm BNC Female Right Angle Max. Freq. 4 GHz</p> <p>Model No: <a href="#">PE9361</a></p>	PRICE		1-24	\$40.26	25-49	\$38.25	50-99	\$36.23	100+	\$34.62																				
PRICE																																																							
1-9	\$334.04																																																						
10-24	\$317.34																																																						
25-49	\$300.64																																																						
50+	\$287.27																																																						
PRICE																																																							
1-24	\$28.28																																																						
25-49	\$26.87																																																						
50-99	\$25.45																																																						
100+	\$24.32																																																						
PRICE																																																							
1-24	\$40.26																																																						
25-49	\$38.25																																																						
50-99	\$36.23																																																						
100+	\$34.62																																																						
6	 <table border="1"> <thead> <tr> <th colspan="2">PRICE</th> </tr> </thead> <tbody> <tr> <td>1-24</td> <td>\$42.65</td> </tr> <tr> <td>25-49</td> <td>\$40.52</td> </tr> <tr> <td>50-99</td> <td>\$38.39</td> </tr> <tr> <td>100+</td> <td>\$36.68</td> </tr> </tbody> </table> <p>75 Ohm BNC Female to 75 Ohm BNC Male Tee Max. Freq. 100 MHz</p> <p>Model No: <a href="#">PE9365</a></p>	PRICE		1-24	\$42.65	25-49	\$40.52	50-99	\$38.39	100+	\$36.68	 <table border="1"> <thead> <tr> <th colspan="2">PRICE</th> </tr> </thead> <tbody> <tr> <td>1-24</td> <td>\$28.39</td> </tr> <tr> <td>25-49</td> <td>\$26.97</td> </tr> <tr> <td>50-99</td> <td>\$25.55</td> </tr> <tr> <td>100+</td> <td>\$24.42</td> </tr> </tbody> </table> <p>75 Ohm BNC Female to 75 Ohm BNC Female VSWR 1.3:1 to 1,000 MHz</p> <p>Model No: <a href="#">PE9362</a></p>	PRICE		1-24	\$28.39	25-49	\$26.97	50-99	\$25.55	100+	\$24.42	 <table border="1"> <thead> <tr> <th colspan="2">PRICE</th> </tr> </thead> <tbody> <tr> <td>1-24</td> <td>\$39.28</td> </tr> <tr> <td>25-49</td> <td>\$37.32</td> </tr> <tr> <td>50-99</td> <td>\$35.35</td> </tr> <tr> <td>100+</td> <td>\$33.78</td> </tr> </tbody> </table> <p>75 Ohm BNC Female to 75 Ohm BNC Female Bulkhead VSWR 1.3:1 to 1,000 MHz</p> <p>Model No: <a href="#">PE9363</a></p>	PRICE		1-24	\$39.28	25-49	\$37.32	50-99	\$35.35	100+	\$33.78	 <table border="1"> <thead> <tr> <th colspan="2">PRICE</th> </tr> </thead> <tbody> <tr> <td>1-24</td> <td>\$43.19</td> </tr> <tr> <td>25-49</td> <td>\$41.03</td> </tr> <tr> <td>50-99</td> <td>\$38.87</td> </tr> <tr> <td>100+</td> <td>\$37.14</td> </tr> </tbody> </table> <p>75 Ohm BNC Female to 75 Ohm BNC Female 4 Hole Flange-Mounting Hole A03 Max. Freq. 1,000 MHz</p> <p>Model No: <a href="#">PE9367</a></p>	PRICE		1-24	\$43.19	25-49	\$41.03	50-99	\$38.87	100+	\$37.14	<p style="text-align: center;"><b>75 Ohm BNC Between Series</b></p> <p style="text-align: center;">→</p>										
PRICE																																																							
1-24	\$42.65																																																						
25-49	\$40.52																																																						
50-99	\$38.39																																																						
100+	\$36.68																																																						
PRICE																																																							
1-24	\$28.39																																																						
25-49	\$26.97																																																						
50-99	\$25.55																																																						
100+	\$24.42																																																						
PRICE																																																							
1-24	\$39.28																																																						
25-49	\$37.32																																																						
50-99	\$35.35																																																						
100+	\$33.78																																																						
PRICE																																																							
1-24	\$43.19																																																						
25-49	\$41.03																																																						
50-99	\$38.87																																																						
100+	\$37.14																																																						
7	 <table border="1"> <thead> <tr> <th colspan="2">PRICE</th> </tr> </thead> <tbody> <tr> <td>1-24</td> <td>\$24.82</td> </tr> <tr> <td>25-49</td> <td>\$23.58</td> </tr> <tr> <td>50-99</td> <td>\$22.34</td> </tr> <tr> <td>100+</td> <td>\$21.35</td> </tr> </tbody> </table> <p>75 Ohm BNC Female to 75 Ohm F Female Bulkhead VSWR 1.3:1 to 1,000 MHz</p> <p>Model No: <a href="#">PE91324</a></p>	PRICE		1-24	\$24.82	25-49	\$23.58	50-99	\$22.34	100+	\$21.35	<p style="text-align: center;"><b>75 Ohm F In-Series</b></p> <p style="text-align: center;">→</p>	 <table border="1"> <thead> <tr> <th colspan="2">PRICE</th> </tr> </thead> <tbody> <tr> <td>1-24</td> <td>\$40.71</td> </tr> <tr> <td>25-49</td> <td>\$38.67</td> </tr> <tr> <td>50-99</td> <td>\$36.64</td> </tr> <tr> <td>PRECISION NEW 100+</td> <td>\$35.01</td> </tr> </tbody> </table> <p>75 Ohm F Male to 75 Ohm F Male VSWR 1.17:1 to 3 GHz</p> <p>Model No: <a href="#">PE91348</a></p>	PRICE		1-24	\$40.71	25-49	\$38.67	50-99	\$36.64	PRECISION NEW 100+	\$35.01	 <table border="1"> <thead> <tr> <th colspan="2">PRICE</th> </tr> </thead> <tbody> <tr> <td>1-24</td> <td>\$104.05</td> </tr> <tr> <td>25-49</td> <td>\$98.85</td> </tr> <tr> <td>50-99</td> <td>\$93.65</td> </tr> <tr> <td>100+</td> <td>\$89.48</td> </tr> </tbody> </table> <p>75 Ohm F Male to 75 Ohm F Male VSWR 1.3:1 to 3 GHz</p> <p>Model No: <a href="#">PE9760</a></p>	PRICE		1-24	\$104.05	25-49	\$98.85	50-99	\$93.65	100+	\$89.48	 <table border="1"> <thead> <tr> <th colspan="2">PRICE</th> </tr> </thead> <tbody> <tr> <td>1-24</td> <td>\$8.98</td> </tr> <tr> <td>25-49</td> <td>\$8.53</td> </tr> <tr> <td>50-99</td> <td>\$8.08</td> </tr> <tr> <td>100+</td> <td>\$7.72</td> </tr> </tbody> </table> <p>75 Ohm Push-On F Male to 75 Ohm F Female VSWR 1.5:1 to 1,000 MHz</p> <p>Model No: <a href="#">PE9160</a></p>	PRICE		1-24	\$8.98	25-49	\$8.53	50-99	\$8.08	100+	\$7.72										
PRICE																																																							
1-24	\$24.82																																																						
25-49	\$23.58																																																						
50-99	\$22.34																																																						
100+	\$21.35																																																						
PRICE																																																							
1-24	\$40.71																																																						
25-49	\$38.67																																																						
50-99	\$36.64																																																						
PRECISION NEW 100+	\$35.01																																																						
PRICE																																																							
1-24	\$104.05																																																						
25-49	\$98.85																																																						
50-99	\$93.65																																																						
100+	\$89.48																																																						
PRICE																																																							
1-24	\$8.98																																																						
25-49	\$8.53																																																						
50-99	\$8.08																																																						
100+	\$7.72																																																						

# ADAPTERS

See Adapter Locator on Pages 8-13

See Page 369 for Mounting Holes

	A	B	C	D	E																																																		
1	 <table border="1"> <thead> <tr> <th colspan="2">PRICE</th> </tr> </thead> <tbody> <tr> <td>1-24</td> <td>\$104.05</td> </tr> <tr> <td>25-49</td> <td>\$98.85</td> </tr> <tr> <td>50-99</td> <td>\$93.65</td> </tr> <tr> <td>100+</td> <td>\$89.48</td> </tr> </tbody> </table> <p>75 Ohm F Male to 75 Ohm F Female VSWR 1.3:1 to 3 GHz Model No: <a href="#">PE9759</a></p>	PRICE		1-24	\$104.05	25-49	\$98.85	50-99	\$93.65	100+	\$89.48	 <table border="1"> <thead> <tr> <th colspan="2">PRICE</th> </tr> </thead> <tbody> <tr> <td>1-24</td> <td>\$10.66</td> </tr> <tr> <td>25-49</td> <td>\$10.13</td> </tr> <tr> <td>50-99</td> <td>\$9.59</td> </tr> <tr> <td>100+</td> <td>\$9.17</td> </tr> </tbody> </table> <p>75 Ohm F Male to 75 Ohm F Female Right Angle Max. Freq. 1,000 MHz Model No: <a href="#">PE9166</a></p>	PRICE		1-24	\$10.66	25-49	\$10.13	50-99	\$9.59	100+	\$9.17	 <table border="1"> <thead> <tr> <th colspan="2">PRICE</th> </tr> </thead> <tbody> <tr> <td>1-24</td> <td>\$25.43</td> </tr> <tr> <td>25-49</td> <td>\$24.16</td> </tr> <tr> <td>50-99</td> <td>\$22.89</td> </tr> <tr> <td>100+</td> <td>\$21.87</td> </tr> </tbody> </table> <p>75 Ohm F Female to 75 Ohm F Female VSWR 1.28:1 to 3 GHz Model No: <a href="#">PE91349</a></p>	PRICE		1-24	\$25.43	25-49	\$24.16	50-99	\$22.89	100+	\$21.87	 <table border="1"> <thead> <tr> <th colspan="2">PRICE</th> </tr> </thead> <tbody> <tr> <td>1-24</td> <td>\$2.86</td> </tr> <tr> <td>25-49</td> <td>\$2.72</td> </tr> <tr> <td>50-99</td> <td>\$2.57</td> </tr> <tr> <td>100+</td> <td>\$2.46</td> </tr> </tbody> </table> <p>75 Ohm F Female to 75 Ohm F Female VSWR 1.35:1 to 500 MHz Model No: <a href="#">PE9164</a></p>	PRICE		1-24	\$2.86	25-49	\$2.72	50-99	\$2.57	100+	\$2.46	 <table border="1"> <thead> <tr> <th colspan="2">PRICE</th> </tr> </thead> <tbody> <tr> <td>1-24</td> <td>\$8.31</td> </tr> <tr> <td>25-49</td> <td>\$7.89</td> </tr> <tr> <td>50-99</td> <td>\$7.48</td> </tr> <tr> <td>100+</td> <td>\$7.15</td> </tr> </tbody> </table> <p>75 Ohm F Female to 75 Ohm F Female Bulkhead-Mounting Hole B04 VSWR 1.3:1 to 250 MHz Model No: <a href="#">PE9734</a></p>	PRICE		1-24	\$8.31	25-49	\$7.89	50-99	\$7.48	100+	\$7.15
PRICE																																																							
1-24	\$104.05																																																						
25-49	\$98.85																																																						
50-99	\$93.65																																																						
100+	\$89.48																																																						
PRICE																																																							
1-24	\$10.66																																																						
25-49	\$10.13																																																						
50-99	\$9.59																																																						
100+	\$9.17																																																						
PRICE																																																							
1-24	\$25.43																																																						
25-49	\$24.16																																																						
50-99	\$22.89																																																						
100+	\$21.87																																																						
PRICE																																																							
1-24	\$2.86																																																						
25-49	\$2.72																																																						
50-99	\$2.57																																																						
100+	\$2.46																																																						
PRICE																																																							
1-24	\$8.31																																																						
25-49	\$7.89																																																						
50-99	\$7.48																																																						
100+	\$7.15																																																						
2	<p><b>75 Ohm F Between Series</b></p> 																																																						
3	 <table border="1"> <thead> <tr> <th colspan="2">PRICE</th> </tr> </thead> <tbody> <tr> <td>1-9</td> <td>\$146.84</td> </tr> <tr> <td>10-24</td> <td>\$139.50</td> </tr> <tr> <td>25-49</td> <td>\$132.16</td> </tr> <tr> <td>50+</td> <td>\$126.28</td> </tr> </tbody> </table> <p>75 Ohm F Female to 75 Ohm BNC Male VSWR 1.3:1 to 3 GHz Model No: <a href="#">PE9741</a></p>	PRICE		1-9	\$146.84	10-24	\$139.50	25-49	\$132.16	50+	\$126.28	 <table border="1"> <thead> <tr> <th colspan="2">PRICE</th> </tr> </thead> <tbody> <tr> <td>1-9</td> <td>\$150.98</td> </tr> <tr> <td>10-24</td> <td>\$143.43</td> </tr> <tr> <td>25-49</td> <td>\$135.88</td> </tr> <tr> <td>50+</td> <td>\$129.84</td> </tr> </tbody> </table> <p>75 Ohm F Female to 75 Ohm BNC Female VSWR 1.3:1 to 3 GHz Model No: <a href="#">PE9744</a></p>	PRICE		1-9	\$150.98	10-24	\$143.43	25-49	\$135.88	50+	\$129.84	 <table border="1"> <thead> <tr> <th colspan="2">PRICE</th> </tr> </thead> <tbody> <tr> <td>1-24</td> <td>\$18.49</td> </tr> <tr> <td>25-49</td> <td>\$17.57</td> </tr> <tr> <td>50-99</td> <td>\$16.64</td> </tr> <tr> <td>100+</td> <td>\$15.90</td> </tr> </tbody> </table> <p>75 Ohm F Female to 75 Ohm PAL Jack VSWR 1.3:1 to 3 GHz Model No: <a href="#">PE9743</a></p>	PRICE		1-24	\$18.49	25-49	\$17.57	50-99	\$16.64	100+	\$15.90	 <table border="1"> <thead> <tr> <th colspan="2">PRICE</th> </tr> </thead> <tbody> <tr> <td>1-24</td> <td>\$18.49</td> </tr> <tr> <td>25-49</td> <td>\$17.57</td> </tr> <tr> <td>50-99</td> <td>\$16.64</td> </tr> <tr> <td>100+</td> <td>\$15.90</td> </tr> </tbody> </table> <p>75 Ohm F Female to 75 Ohm PAL Plug Model No: <a href="#">PE9633</a></p>	PRICE		1-24	\$18.49	25-49	\$17.57	50-99	\$16.64	100+	\$15.90	 <table border="1"> <thead> <tr> <th colspan="2">PRICE</th> </tr> </thead> <tbody> <tr> <td>1-24</td> <td>\$18.49</td> </tr> <tr> <td>25-49</td> <td>\$17.57</td> </tr> <tr> <td>50-99</td> <td>\$16.64</td> </tr> <tr> <td>100+</td> <td>\$15.90</td> </tr> </tbody> </table> <p>75 Ohm F Female to 75 Ohm PAL Jack Model No: <a href="#">PE9632</a></p>	PRICE		1-24	\$18.49	25-49	\$17.57	50-99	\$16.64	100+	\$15.90
PRICE																																																							
1-9	\$146.84																																																						
10-24	\$139.50																																																						
25-49	\$132.16																																																						
50+	\$126.28																																																						
PRICE																																																							
1-9	\$150.98																																																						
10-24	\$143.43																																																						
25-49	\$135.88																																																						
50+	\$129.84																																																						
PRICE																																																							
1-24	\$18.49																																																						
25-49	\$17.57																																																						
50-99	\$16.64																																																						
100+	\$15.90																																																						
PRICE																																																							
1-24	\$18.49																																																						
25-49	\$17.57																																																						
50-99	\$16.64																																																						
100+	\$15.90																																																						
PRICE																																																							
1-24	\$18.49																																																						
25-49	\$17.57																																																						
50-99	\$16.64																																																						
100+	\$15.90																																																						
4	 <table border="1"> <thead> <tr> <th colspan="2">PRICE</th> </tr> </thead> <tbody> <tr> <td>1-24</td> <td>\$37.13</td> </tr> <tr> <td>25-49</td> <td>\$35.27</td> </tr> <tr> <td>50-99</td> <td>\$33.42</td> </tr> <tr> <td>100+</td> <td>\$31.93</td> </tr> </tbody> </table> <p>75 Ohm Mini SMB Plug to 75 Ohm Mini SMB Plug Model No: <a href="#">PE9609</a></p>	PRICE		1-24	\$37.13	25-49	\$35.27	50-99	\$33.42	100+	\$31.93	 <table border="1"> <thead> <tr> <th colspan="2">PRICE</th> </tr> </thead> <tbody> <tr> <td>1-24</td> <td>\$53.27</td> </tr> <tr> <td>25-49</td> <td>\$50.61</td> </tr> <tr> <td>50-99</td> <td>\$47.94</td> </tr> <tr> <td>100+</td> <td>\$45.81</td> </tr> </tbody> </table> <p>75 Ohm Mini SMB Plug to 75 Ohm Mini SMB Jack Model No: <a href="#">PE9610</a></p>	PRICE		1-24	\$53.27	25-49	\$50.61	50-99	\$47.94	100+	\$45.81	 <table border="1"> <thead> <tr> <th colspan="2">PRICE</th> </tr> </thead> <tbody> <tr> <td>1-24</td> <td>\$37.13</td> </tr> <tr> <td>25-49</td> <td>\$35.27</td> </tr> <tr> <td>50-99</td> <td>\$33.42</td> </tr> <tr> <td>100+</td> <td>\$31.93</td> </tr> </tbody> </table> <p>75 Ohm Mini SMB Jack to 75 Ohm Mini SMB Jack Model No: <a href="#">PE9608</a></p>	PRICE		1-24	\$37.13	25-49	\$35.27	50-99	\$33.42	100+	\$31.93	 <table border="1"> <thead> <tr> <th colspan="2">PRICE</th> </tr> </thead> <tbody> <tr> <td>1-24</td> <td>\$48.86</td> </tr> <tr> <td>25-49</td> <td>\$46.42</td> </tr> <tr> <td>50-99</td> <td>\$43.97</td> </tr> <tr> <td>100+</td> <td>\$42.02</td> </tr> </tbody> </table> <p>75 Ohm Mini SMB Jack to 75 Ohm Mini SMB Jack Bulkhead Model No: <a href="#">PE9611</a></p>	PRICE		1-24	\$48.86	25-49	\$46.42	50-99	\$43.97	100+	\$42.02	<p style="text-align: center;"><b>75 Ohm Mini SMB In-Series</b></p> 										
PRICE																																																							
1-24	\$37.13																																																						
25-49	\$35.27																																																						
50-99	\$33.42																																																						
100+	\$31.93																																																						
PRICE																																																							
1-24	\$53.27																																																						
25-49	\$50.61																																																						
50-99	\$47.94																																																						
100+	\$45.81																																																						
PRICE																																																							
1-24	\$37.13																																																						
25-49	\$35.27																																																						
50-99	\$33.42																																																						
100+	\$31.93																																																						
PRICE																																																							
1-24	\$48.86																																																						
25-49	\$46.42																																																						
50-99	\$43.97																																																						
100+	\$42.02																																																						
5	 <table border="1"> <thead> <tr> <th colspan="2">PRICE</th> </tr> </thead> <tbody> <tr> <td>1-24</td> <td>\$77.08</td> </tr> <tr> <td>25-49</td> <td>\$73.23</td> </tr> <tr> <td>50-99</td> <td>\$69.37</td> </tr> <tr> <td>100+</td> <td>\$66.29</td> </tr> </tbody> </table> <p>75 Ohm Mini SMB Plug to 75 Ohm BNC Male Model No: <a href="#">PE9616</a></p>	PRICE		1-24	\$77.08	25-49	\$73.23	50-99	\$69.37	100+	\$66.29	 <table border="1"> <thead> <tr> <th colspan="2">PRICE</th> </tr> </thead> <tbody> <tr> <td>1-24</td> <td>\$64.16</td> </tr> <tr> <td>25-49</td> <td>\$60.95</td> </tr> <tr> <td>50-99</td> <td>\$57.74</td> </tr> <tr> <td>100+</td> <td>\$55.18</td> </tr> </tbody> </table> <p>75 Ohm Mini SMB Plug to 75 Ohm BNC Female Model No: <a href="#">PE9617</a></p>	PRICE		1-24	\$64.16	25-49	\$60.95	50-99	\$57.74	100+	\$55.18	 <table border="1"> <thead> <tr> <th colspan="2">PRICE</th> </tr> </thead> <tbody> <tr> <td>1-24</td> <td>\$81.82</td> </tr> <tr> <td>25-49</td> <td>\$77.73</td> </tr> <tr> <td>50-99</td> <td>\$73.64</td> </tr> <tr> <td>100+</td> <td>\$70.37</td> </tr> </tbody> </table> <p>75 Ohm Mini SMB Jack to 75 Ohm BNC Male Model No: <a href="#">PE9618</a></p>	PRICE		1-24	\$81.82	25-49	\$77.73	50-99	\$73.64	100+	\$70.37	 <table border="1"> <thead> <tr> <th colspan="2">PRICE</th> </tr> </thead> <tbody> <tr> <td>1-24</td> <td>\$91.32</td> </tr> <tr> <td>25-49</td> <td>\$86.75</td> </tr> <tr> <td>50-99</td> <td>\$82.19</td> </tr> <tr> <td>100+</td> <td>\$78.54</td> </tr> </tbody> </table> <p>75 Ohm Mini SMB Jack to 75 Ohm BNC Female Model No: <a href="#">PE9619</a></p>	PRICE		1-24	\$91.32	25-49	\$86.75	50-99	\$82.19	100+	\$78.54	<p style="text-align: center;"><b>75 Ohm N In-Series</b></p> 										
PRICE																																																							
1-24	\$77.08																																																						
25-49	\$73.23																																																						
50-99	\$69.37																																																						
100+	\$66.29																																																						
PRICE																																																							
1-24	\$64.16																																																						
25-49	\$60.95																																																						
50-99	\$57.74																																																						
100+	\$55.18																																																						
PRICE																																																							
1-24	\$81.82																																																						
25-49	\$77.73																																																						
50-99	\$73.64																																																						
100+	\$70.37																																																						
PRICE																																																							
1-24	\$91.32																																																						
25-49	\$86.75																																																						
50-99	\$82.19																																																						
100+	\$78.54																																																						
6	 <table border="1"> <thead> <tr> <th colspan="2">PRICE</th> </tr> </thead> <tbody> <tr> <td>1-24</td> <td>\$37.28</td> </tr> <tr> <td>25-49</td> <td>\$35.42</td> </tr> <tr> <td>50-99</td> <td>\$33.55</td> </tr> <tr> <td>100+</td> <td>\$32.06</td> </tr> </tbody> </table> <p>75 Ohm N Male to 75 Ohm N Male Max. Freq. 1.5 GHz Model No: <a href="#">PE9308</a></p>	PRICE		1-24	\$37.28	25-49	\$35.42	50-99	\$33.55	100+	\$32.06	 <table border="1"> <thead> <tr> <th colspan="2">PRICE</th> </tr> </thead> <tbody> <tr> <td>1-24</td> <td>\$37.53</td> </tr> <tr> <td>25-49</td> <td>\$35.65</td> </tr> <tr> <td>50-99</td> <td>\$33.78</td> </tr> <tr> <td>100+</td> <td>\$32.28</td> </tr> </tbody> </table> <p>75 Ohm N Male to 75 Ohm N Female Max. Freq. 1.5 GHz Model No: <a href="#">PE9391</a></p>	PRICE		1-24	\$37.53	25-49	\$35.65	50-99	\$33.78	100+	\$32.28	 <table border="1"> <thead> <tr> <th colspan="2">PRICE</th> </tr> </thead> <tbody> <tr> <td>1-24</td> <td>\$47.38</td> </tr> <tr> <td>25-49</td> <td>\$45.01</td> </tr> <tr> <td>50-99</td> <td>\$42.64</td> </tr> <tr> <td>100+</td> <td>\$40.75</td> </tr> </tbody> </table> <p>75 Ohm N Male to 75 Ohm N Female Right Angle Max. Freq. 1.5 GHz Model No: <a href="#">PE9307</a></p>	PRICE		1-24	\$47.38	25-49	\$45.01	50-99	\$42.64	100+	\$40.75	 <table border="1"> <thead> <tr> <th colspan="2">PRICE</th> </tr> </thead> <tbody> <tr> <td>1-24</td> <td>\$35.66</td> </tr> <tr> <td>25-49</td> <td>\$33.88</td> </tr> <tr> <td>50-99</td> <td>\$32.09</td> </tr> <tr> <td>100+</td> <td>\$30.67</td> </tr> </tbody> </table> <p>75 Ohm N Female to 75 Ohm N Female VSWR 1.3:1 to 1,000 MHz Model No: <a href="#">PE9306</a></p>	PRICE		1-24	\$35.66	25-49	\$33.88	50-99	\$32.09	100+	\$30.67	 <table border="1"> <thead> <tr> <th colspan="2">PRICE</th> </tr> </thead> <tbody> <tr> <td>1-24</td> <td>\$114.06</td> </tr> <tr> <td>25-49</td> <td>\$108.36</td> </tr> <tr> <td>50-99</td> <td>\$102.65</td> </tr> <tr> <td>100+</td> <td>\$98.09</td> </tr> </tbody> </table> <p>75 Ohm N Female to 75 Ohm N Female Bulkhead-Mounting Hole G01 Model No: <a href="#">PE9417</a></p>	PRICE		1-24	\$114.06	25-49	\$108.36	50-99	\$102.65	100+	\$98.09
PRICE																																																							
1-24	\$37.28																																																						
25-49	\$35.42																																																						
50-99	\$33.55																																																						
100+	\$32.06																																																						
PRICE																																																							
1-24	\$37.53																																																						
25-49	\$35.65																																																						
50-99	\$33.78																																																						
100+	\$32.28																																																						
PRICE																																																							
1-24	\$47.38																																																						
25-49	\$45.01																																																						
50-99	\$42.64																																																						
100+	\$40.75																																																						
PRICE																																																							
1-24	\$35.66																																																						
25-49	\$33.88																																																						
50-99	\$32.09																																																						
100+	\$30.67																																																						
PRICE																																																							
1-24	\$114.06																																																						
25-49	\$108.36																																																						
50-99	\$102.65																																																						
100+	\$98.09																																																						
7	 <table border="1"> <thead> <tr> <th colspan="2">PRICE</th> </tr> </thead> <tbody> <tr> <td>1-24</td> <td>\$54.97</td> </tr> <tr> <td>25-49</td> <td>\$52.22</td> </tr> <tr> <td>50-99</td> <td>\$49.47</td> </tr> <tr> <td>100+</td> <td>\$47.27</td> </tr> </tbody> </table> <p>75 Ohm N Female to 75 Ohm N Female Bulkhead VSWR 1.35:1 to 1.5 GHz Model No: <a href="#">PE9416</a></p>	PRICE		1-24	\$54.97	25-49	\$52.22	50-99	\$49.47	100+	\$47.27	<p><b>75 Ohm N Between Series</b></p> 			 <table border="1"> <thead> <tr> <th colspan="2">PRICE</th> </tr> </thead> <tbody> <tr> <td>1-24</td> <td>\$70.56</td> </tr> <tr> <td>25-49</td> <td>\$67.03</td> </tr> <tr> <td>50-99</td> <td>\$63.50</td> </tr> <tr> <td>100+</td> <td>\$60.68</td> </tr> </tbody> </table> <p>75 Ohm N Male to 75 Ohm BNC Male Max. Freq. 1,000 MHz Model No: <a href="#">PE9370</a></p>	PRICE		1-24	\$70.56	25-49	\$67.03	50-99	\$63.50	100+	\$60.68	 <table border="1"> <thead> <tr> <th colspan="2">PRICE</th> </tr> </thead> <tbody> <tr> <td>1-24</td> <td>\$36.43</td> </tr> <tr> <td>25-49</td> <td>\$34.61</td> </tr> <tr> <td>50-99</td> <td>\$32.79</td> </tr> <tr> <td>100+</td> <td>\$31.33</td> </tr> </tbody> </table> <p>75 Ohm N Male to 75 Ohm BNC Female VSWR 1.3:1 to 1,000 MHz Model No: <a href="#">PE9369</a></p>	PRICE		1-24	\$36.43	25-49	\$34.61	50-99	\$32.79	100+	\$31.33	 <table border="1"> <thead> <tr> <th colspan="2">PRICE</th> </tr> </thead> <tbody> <tr> <td>1-24</td> <td>\$120.09</td> </tr> <tr> <td>25-49</td> <td>\$114.09</td> </tr> <tr> <td>50-99</td> <td>\$108.08</td> </tr> <tr> <td>100+</td> <td>\$103.28</td> </tr> </tbody> </table> <p>75 Ohm N Male to 75 Ohm F Male VSWR 1.3:1 to 3 GHz Model No: <a href="#">PE9738</a></p>	PRICE		1-24	\$120.09	25-49	\$114.09	50-99	\$108.08	100+	\$103.28								
PRICE																																																							
1-24	\$54.97																																																						
25-49	\$52.22																																																						
50-99	\$49.47																																																						
100+	\$47.27																																																						
PRICE																																																							
1-24	\$70.56																																																						
25-49	\$67.03																																																						
50-99	\$63.50																																																						
100+	\$60.68																																																						
PRICE																																																							
1-24	\$36.43																																																						
25-49	\$34.61																																																						
50-99	\$32.79																																																						
100+	\$31.33																																																						
PRICE																																																							
1-24	\$120.09																																																						
25-49	\$114.09																																																						
50-99	\$108.08																																																						
100+	\$103.28																																																						

# ADAPTERS

See Adapter Locator on Pages 8-13

See Page 369 for Mounting Holes

Adapters

See Our Website For Current Pricing & Real-Time Stock Availability!

	A	B	C	D	E																																																		
1	 <table border="1"> <thead> <tr> <th colspan="2">PRICE</th> </tr> </thead> <tbody> <tr> <td>1-24</td> <td>\$46.30</td> </tr> <tr> <td>25-49</td> <td>\$43.99</td> </tr> <tr> <td>50-99</td> <td>\$41.67</td> </tr> <tr> <td>100+</td> <td>\$39.82</td> </tr> </tbody> </table> <p>75 Ohm N Male to 75 Ohm F Female Max. Freq. 1,000 MHz Model No: <a href="#">PE9396</a></p>	PRICE		1-24	\$46.30	25-49	\$43.99	50-99	\$41.67	100+	\$39.82	 <table border="1"> <thead> <tr> <th colspan="2">PRICE</th> </tr> </thead> <tbody> <tr> <td>1-9</td> <td>\$134.62</td> </tr> <tr> <td>10-24</td> <td>\$127.89</td> </tr> <tr> <td>25-49</td> <td>\$121.16</td> </tr> <tr> <td>50+</td> <td>\$115.77</td> </tr> </tbody> </table> <p>75 Ohm N Male to 75 Ohm F Female VSWR 1.3:1 to 3 GHz Model No: <a href="#">PE9737</a></p>	PRICE		1-9	\$134.62	10-24	\$127.89	25-49	\$121.16	50+	\$115.77	 <table border="1"> <thead> <tr> <th colspan="2">PRICE</th> </tr> </thead> <tbody> <tr> <td>1-24</td> <td>\$101.52</td> </tr> <tr> <td>25-49</td> <td>\$96.44</td> </tr> <tr> <td>50-99</td> <td>\$91.37</td> </tr> <tr> <td>100+</td> <td>\$87.31</td> </tr> </tbody> </table> <p>75 Ohm N Male to 75 Ohm Mini SMB Plug Model No: <a href="#">PE9612</a></p>	PRICE		1-24	\$101.52	25-49	\$96.44	50-99	\$91.37	100+	\$87.31	 <table border="1"> <thead> <tr> <th colspan="2">PRICE</th> </tr> </thead> <tbody> <tr> <td>1-24</td> <td>\$85.72</td> </tr> <tr> <td>25-49</td> <td>\$81.43</td> </tr> <tr> <td>50-99</td> <td>\$77.15</td> </tr> <tr> <td>100+</td> <td>\$73.72</td> </tr> </tbody> </table> <p>75 Ohm N Male to 75 Ohm Mini SMB Jack Model No: <a href="#">PE9614</a></p>	PRICE		1-24	\$85.72	25-49	\$81.43	50-99	\$77.15	100+	\$73.72	 <table border="1"> <thead> <tr> <th colspan="2">PRICE</th> </tr> </thead> <tbody> <tr> <td>1-24</td> <td>\$110.68</td> </tr> <tr> <td>25-49</td> <td>\$105.15</td> </tr> <tr> <td>50-99</td> <td>\$99.61</td> </tr> <tr> <td>100+</td> <td>\$95.18</td> </tr> </tbody> </table> <p>75 Ohm N Male to 75 Ohm SMB Plug Model No: <a href="#">PE9584</a></p>	PRICE		1-24	\$110.68	25-49	\$105.15	50-99	\$99.61	100+	\$95.18
PRICE																																																							
1-24	\$46.30																																																						
25-49	\$43.99																																																						
50-99	\$41.67																																																						
100+	\$39.82																																																						
PRICE																																																							
1-9	\$134.62																																																						
10-24	\$127.89																																																						
25-49	\$121.16																																																						
50+	\$115.77																																																						
PRICE																																																							
1-24	\$101.52																																																						
25-49	\$96.44																																																						
50-99	\$91.37																																																						
100+	\$87.31																																																						
PRICE																																																							
1-24	\$85.72																																																						
25-49	\$81.43																																																						
50-99	\$77.15																																																						
100+	\$73.72																																																						
PRICE																																																							
1-24	\$110.68																																																						
25-49	\$105.15																																																						
50-99	\$99.61																																																						
100+	\$95.18																																																						
2	 <table border="1"> <thead> <tr> <th colspan="2">PRICE</th> </tr> </thead> <tbody> <tr> <td>1-24</td> <td>\$87.29</td> </tr> <tr> <td>25-49</td> <td>\$82.93</td> </tr> <tr> <td>50-99</td> <td>\$78.56</td> </tr> <tr> <td>100+</td> <td>\$75.07</td> </tr> </tbody> </table> <p>75 Ohm N Male to 75 Ohm SMB Jack Model No: <a href="#">PE9582</a></p>	PRICE		1-24	\$87.29	25-49	\$82.93	50-99	\$78.56	100+	\$75.07	 <table border="1"> <thead> <tr> <th colspan="2">PRICE</th> </tr> </thead> <tbody> <tr> <td>1-24</td> <td>\$85.68</td> </tr> <tr> <td>25-49</td> <td>\$81.40</td> </tr> <tr> <td>50-99</td> <td>\$77.11</td> </tr> <tr> <td>100+</td> <td>\$73.68</td> </tr> </tbody> </table> <p>75 Ohm N Male to 75 Ohm SMC Plug Model No: <a href="#">PE9588</a></p>	PRICE		1-24	\$85.68	25-49	\$81.40	50-99	\$77.11	100+	\$73.68	 <table border="1"> <thead> <tr> <th colspan="2">PRICE</th> </tr> </thead> <tbody> <tr> <td>1-24</td> <td>\$88.65</td> </tr> <tr> <td>25-49</td> <td>\$84.22</td> </tr> <tr> <td>50-99</td> <td>\$79.79</td> </tr> <tr> <td>100+</td> <td>\$76.24</td> </tr> </tbody> </table> <p>75 Ohm N Male to 75 Ohm SMC Jack Model No: <a href="#">PE9586</a></p>	PRICE		1-24	\$88.65	25-49	\$84.22	50-99	\$79.79	100+	\$76.24	 <table border="1"> <thead> <tr> <th colspan="2">PRICE</th> </tr> </thead> <tbody> <tr> <td>1-24</td> <td>\$77.57</td> </tr> <tr> <td>25-49</td> <td>\$73.69</td> </tr> <tr> <td>50-99</td> <td>\$69.81</td> </tr> <tr> <td>100+</td> <td>\$66.71</td> </tr> </tbody> </table> <p>75 Ohm N Male to 75 Ohm TNC Male Max. Freq. 500 MHz Model No: <a href="#">PE9626</a></p>	PRICE		1-24	\$77.57	25-49	\$73.69	50-99	\$69.81	100+	\$66.71	 <table border="1"> <thead> <tr> <th colspan="2">PRICE</th> </tr> </thead> <tbody> <tr> <td>1-24</td> <td>\$53.27</td> </tr> <tr> <td>25-49</td> <td>\$50.61</td> </tr> <tr> <td>50-99</td> <td>\$47.94</td> </tr> <tr> <td>100+</td> <td>\$45.81</td> </tr> </tbody> </table> <p>75 Ohm N Male to 75 Ohm TNC Female Max. Freq. 500 MHz Model No: <a href="#">PE9627</a></p>	PRICE		1-24	\$53.27	25-49	\$50.61	50-99	\$47.94	100+	\$45.81
PRICE																																																							
1-24	\$87.29																																																						
25-49	\$82.93																																																						
50-99	\$78.56																																																						
100+	\$75.07																																																						
PRICE																																																							
1-24	\$85.68																																																						
25-49	\$81.40																																																						
50-99	\$77.11																																																						
100+	\$73.68																																																						
PRICE																																																							
1-24	\$88.65																																																						
25-49	\$84.22																																																						
50-99	\$79.79																																																						
100+	\$76.24																																																						
PRICE																																																							
1-24	\$77.57																																																						
25-49	\$73.69																																																						
50-99	\$69.81																																																						
100+	\$66.71																																																						
PRICE																																																							
1-24	\$53.27																																																						
25-49	\$50.61																																																						
50-99	\$47.94																																																						
100+	\$45.81																																																						
3	 <table border="1"> <thead> <tr> <th colspan="2">PRICE</th> </tr> </thead> <tbody> <tr> <td>1-24</td> <td>\$37.28</td> </tr> <tr> <td>25-49</td> <td>\$35.42</td> </tr> <tr> <td>50-99</td> <td>\$33.55</td> </tr> <tr> <td>100+</td> <td>\$32.06</td> </tr> </tbody> </table> <p>75 Ohm N Female to 75 Ohm BNC Male Max. Freq. 1,000 MHz Model No: <a href="#">PE9368</a></p>	PRICE		1-24	\$37.28	25-49	\$35.42	50-99	\$33.55	100+	\$32.06	 <table border="1"> <thead> <tr> <th colspan="2">PRICE</th> </tr> </thead> <tbody> <tr> <td>1-24</td> <td>\$49.17</td> </tr> <tr> <td>25-49</td> <td>\$46.71</td> </tr> <tr> <td>50-99</td> <td>\$44.25</td> </tr> <tr> <td>100+</td> <td>\$42.29</td> </tr> </tbody> </table> <p>75 Ohm N Female to 75 Ohm BNC Female Max. Freq. 1,000 MHz Model No: <a href="#">PE9371</a></p>	PRICE		1-24	\$49.17	25-49	\$46.71	50-99	\$44.25	100+	\$42.29	 <table border="1"> <thead> <tr> <th colspan="2">PRICE</th> </tr> </thead> <tbody> <tr> <td>1-24</td> <td>\$48.56</td> </tr> <tr> <td>25-49</td> <td>\$46.13</td> </tr> <tr> <td>50-99</td> <td>\$43.70</td> </tr> <tr> <td>100+</td> <td>\$41.76</td> </tr> </tbody> </table> <p>75 Ohm N Female to 75 Ohm F Male VSWR 1.3:1 to 3 GHz Model No: <a href="#">PE9397</a></p>	PRICE		1-24	\$48.56	25-49	\$46.13	50-99	\$43.70	100+	\$41.76	 <table border="1"> <thead> <tr> <th colspan="2">PRICE</th> </tr> </thead> <tbody> <tr> <td>1-24</td> <td>\$117.50</td> </tr> <tr> <td>25-49</td> <td>\$111.63</td> </tr> <tr> <td>50-99</td> <td>\$105.75</td> </tr> <tr> <td>100+</td> <td>\$101.05</td> </tr> </tbody> </table> <p>75 Ohm N Female to 75 Ohm F Male VSWR 1.3:1 to 3 GHz Model No: <a href="#">PE9739</a></p>	PRICE		1-24	\$117.50	25-49	\$111.63	50-99	\$105.75	100+	\$101.05	 <table border="1"> <thead> <tr> <th colspan="2">PRICE</th> </tr> </thead> <tbody> <tr> <td>1-9</td> <td>\$154.28</td> </tr> <tr> <td>10-24</td> <td>\$146.57</td> </tr> <tr> <td>25-49</td> <td>\$138.85</td> </tr> <tr> <td>50+</td> <td>\$132.68</td> </tr> </tbody> </table> <p>75 Ohm N Female to 75 Ohm F Female VSWR 1.3:1 to 3 GHz Model No: <a href="#">PE9740</a></p>	PRICE		1-9	\$154.28	10-24	\$146.57	25-49	\$138.85	50+	\$132.68
PRICE																																																							
1-24	\$37.28																																																						
25-49	\$35.42																																																						
50-99	\$33.55																																																						
100+	\$32.06																																																						
PRICE																																																							
1-24	\$49.17																																																						
25-49	\$46.71																																																						
50-99	\$44.25																																																						
100+	\$42.29																																																						
PRICE																																																							
1-24	\$48.56																																																						
25-49	\$46.13																																																						
50-99	\$43.70																																																						
100+	\$41.76																																																						
PRICE																																																							
1-24	\$117.50																																																						
25-49	\$111.63																																																						
50-99	\$105.75																																																						
100+	\$101.05																																																						
PRICE																																																							
1-9	\$154.28																																																						
10-24	\$146.57																																																						
25-49	\$138.85																																																						
50+	\$132.68																																																						
4	 <table border="1"> <thead> <tr> <th colspan="2">PRICE</th> </tr> </thead> <tbody> <tr> <td>1-9</td> <td>\$115.41</td> </tr> <tr> <td>10-24</td> <td>\$109.64</td> </tr> <tr> <td>25-49</td> <td>\$103.87</td> </tr> <tr> <td>50+</td> <td>\$99.25</td> </tr> </tbody> </table> <p>75 Ohm N Female to 75 Ohm Mini SMB Plug Model No: <a href="#">PE9613</a></p>	PRICE		1-9	\$115.41	10-24	\$109.64	25-49	\$103.87	50+	\$99.25	 <table border="1"> <thead> <tr> <th colspan="2">PRICE</th> </tr> </thead> <tbody> <tr> <td>1-24</td> <td>\$89.14</td> </tr> <tr> <td>25-49</td> <td>\$84.68</td> </tr> <tr> <td>50-99</td> <td>\$80.23</td> </tr> <tr> <td>100+</td> <td>\$76.66</td> </tr> </tbody> </table> <p>75 Ohm N Female to 75 Ohm Mini SMB Jack Max. Freq. 1,000 MHz Model No: <a href="#">PE9615</a></p>	PRICE		1-24	\$89.14	25-49	\$84.68	50-99	\$80.23	100+	\$76.66	 <table border="1"> <thead> <tr> <th colspan="2">PRICE</th> </tr> </thead> <tbody> <tr> <td>1-24</td> <td>\$119.65</td> </tr> <tr> <td>25-49</td> <td>\$113.67</td> </tr> <tr> <td>50-99</td> <td>\$107.69</td> </tr> <tr> <td>100+</td> <td>\$102.90</td> </tr> </tbody> </table> <p>75 Ohm N Female to 75 Ohm SMB Plug Model No: <a href="#">PE9585</a></p>	PRICE		1-24	\$119.65	25-49	\$113.67	50-99	\$107.69	100+	\$102.90	 <table border="1"> <thead> <tr> <th colspan="2">PRICE</th> </tr> </thead> <tbody> <tr> <td>1-24</td> <td>\$102.87</td> </tr> <tr> <td>25-49</td> <td>\$97.73</td> </tr> <tr> <td>50-99</td> <td>\$92.58</td> </tr> <tr> <td>100+</td> <td>\$88.47</td> </tr> </tbody> </table> <p>75 Ohm N Female to 75 Ohm SMB Jack Model No: <a href="#">PE9583</a></p>	PRICE		1-24	\$102.87	25-49	\$97.73	50-99	\$92.58	100+	\$88.47	 <table border="1"> <thead> <tr> <th colspan="2">PRICE</th> </tr> </thead> <tbody> <tr> <td>1-24</td> <td>\$95.26</td> </tr> <tr> <td>25-49</td> <td>\$90.50</td> </tr> <tr> <td>50-99</td> <td>\$85.73</td> </tr> <tr> <td>100+</td> <td>\$81.92</td> </tr> </tbody> </table> <p>75 Ohm N Female to 75 Ohm SMC Plug Model No: <a href="#">PE9589</a></p>	PRICE		1-24	\$95.26	25-49	\$90.50	50-99	\$85.73	100+	\$81.92
PRICE																																																							
1-9	\$115.41																																																						
10-24	\$109.64																																																						
25-49	\$103.87																																																						
50+	\$99.25																																																						
PRICE																																																							
1-24	\$89.14																																																						
25-49	\$84.68																																																						
50-99	\$80.23																																																						
100+	\$76.66																																																						
PRICE																																																							
1-24	\$119.65																																																						
25-49	\$113.67																																																						
50-99	\$107.69																																																						
100+	\$102.90																																																						
PRICE																																																							
1-24	\$102.87																																																						
25-49	\$97.73																																																						
50-99	\$92.58																																																						
100+	\$88.47																																																						
PRICE																																																							
1-24	\$95.26																																																						
25-49	\$90.50																																																						
50-99	\$85.73																																																						
100+	\$81.92																																																						
5	 <table border="1"> <thead> <tr> <th colspan="2">PRICE</th> </tr> </thead> <tbody> <tr> <td>1-24</td> <td>\$94.86</td> </tr> <tr> <td>25-49</td> <td>\$90.12</td> </tr> <tr> <td>50-99</td> <td>\$85.37</td> </tr> <tr> <td>100+</td> <td>\$81.58</td> </tr> </tbody> </table> <p>75 Ohm N Female to 75 Ohm SMC Jack Model No: <a href="#">PE9587</a></p>	PRICE		1-24	\$94.86	25-49	\$90.12	50-99	\$85.37	100+	\$81.58	 <table border="1"> <thead> <tr> <th colspan="2">PRICE</th> </tr> </thead> <tbody> <tr> <td>1-24</td> <td>\$53.27</td> </tr> <tr> <td>25-49</td> <td>\$50.61</td> </tr> <tr> <td>50-99</td> <td>\$47.94</td> </tr> <tr> <td>100+</td> <td>\$45.81</td> </tr> </tbody> </table> <p>75 Ohm N Female to 75 Ohm TNC Male Max. Freq. 500 MHz Model No: <a href="#">PE9628</a></p>	PRICE		1-24	\$53.27	25-49	\$50.61	50-99	\$47.94	100+	\$45.81	 <table border="1"> <thead> <tr> <th colspan="2">PRICE</th> </tr> </thead> <tbody> <tr> <td>1-24</td> <td>\$53.27</td> </tr> <tr> <td>25-49</td> <td>\$50.61</td> </tr> <tr> <td>50-99</td> <td>\$47.94</td> </tr> <tr> <td>100+</td> <td>\$45.81</td> </tr> </tbody> </table> <p>75 Ohm N Female to 75 Ohm TNC Female Max. Freq. 1,000 MHz Model No: <a href="#">PE9629</a></p>	PRICE		1-24	\$53.27	25-49	\$50.61	50-99	\$47.94	100+	\$45.81	<p><b>75 Ohm PAL In-Series</b></p> 		 <table border="1"> <thead> <tr> <th colspan="2">PRICE</th> </tr> </thead> <tbody> <tr> <td>1-24</td> <td>\$11.81</td> </tr> <tr> <td>25-49</td> <td>\$11.22</td> </tr> <tr> <td>50-99</td> <td>\$10.63</td> </tr> <tr> <td>100+</td> <td>\$10.16</td> </tr> </tbody> </table> <p>75 Ohm PAL Plug to 75 Ohm PAL Plug Model No: <a href="#">PE9680</a></p>	PRICE		1-24	\$11.81	25-49	\$11.22	50-99	\$10.63	100+	\$10.16									
PRICE																																																							
1-24	\$94.86																																																						
25-49	\$90.12																																																						
50-99	\$85.37																																																						
100+	\$81.58																																																						
PRICE																																																							
1-24	\$53.27																																																						
25-49	\$50.61																																																						
50-99	\$47.94																																																						
100+	\$45.81																																																						
PRICE																																																							
1-24	\$53.27																																																						
25-49	\$50.61																																																						
50-99	\$47.94																																																						
100+	\$45.81																																																						
PRICE																																																							
1-24	\$11.81																																																						
25-49	\$11.22																																																						
50-99	\$10.63																																																						
100+	\$10.16																																																						
6	<p><b>75 Ohm SMB In-Series</b></p> 		 <table border="1"> <thead> <tr> <th colspan="2">PRICE</th> </tr> </thead> <tbody> <tr> <td>1-24</td> <td>\$61.18</td> </tr> <tr> <td>25-49</td> <td>\$58.12</td> </tr> <tr> <td>50-99</td> <td>\$55.06</td> </tr> <tr> <td>100+</td> <td>\$52.61</td> </tr> </tbody> </table> <p>75 Ohm SMB Plug to 75 Ohm SMB Plug Model No: <a href="#">PE9271</a></p>	PRICE		1-24	\$61.18	25-49	\$58.12	50-99	\$55.06	100+	\$52.61	 <table border="1"> <thead> <tr> <th colspan="2">PRICE</th> </tr> </thead> <tbody> <tr> <td>1-24</td> <td>\$66.37</td> </tr> <tr> <td>25-49</td> <td>\$63.05</td> </tr> <tr> <td>50-99</td> <td>\$59.73</td> </tr> <tr> <td>100+</td> <td>\$57.08</td> </tr> </tbody> </table> <p>75 Ohm SMB Jack to 75 Ohm SMB Plug Tee Model No: <a href="#">PE9245</a></p>	PRICE		1-24	\$66.37	25-49	\$63.05	50-99	\$59.73	100+	\$57.08	 <table border="1"> <thead> <tr> <th colspan="2">PRICE</th> </tr> </thead> <tbody> <tr> <td>1-24</td> <td>\$66.81</td> </tr> <tr> <td>25-49</td> <td>\$63.47</td> </tr> <tr> <td>50-99</td> <td>\$60.13</td> </tr> <tr> <td>100+</td> <td>\$57.46</td> </tr> </tbody> </table> <p>75 Ohm SMB Jack to 75 Ohm SMB Jack Max. Freq. 4 GHz Model No: <a href="#">PE9248</a></p>	PRICE		1-24	\$66.81	25-49	\$63.47	50-99	\$60.13	100+	\$57.46	<p><b>75 Ohm SMB Between Series</b></p> 																			
PRICE																																																							
1-24	\$61.18																																																						
25-49	\$58.12																																																						
50-99	\$55.06																																																						
100+	\$52.61																																																						
PRICE																																																							
1-24	\$66.37																																																						
25-49	\$63.05																																																						
50-99	\$59.73																																																						
100+	\$57.08																																																						
PRICE																																																							
1-24	\$66.81																																																						
25-49	\$63.47																																																						
50-99	\$60.13																																																						
100+	\$57.46																																																						
7	 <table border="1"> <thead> <tr> <th colspan="2">PRICE</th> </tr> </thead> <tbody> <tr> <td>1-24</td> <td>\$66.06</td> </tr> <tr> <td>25-49</td> <td>\$62.76</td> </tr> <tr> <td>50-99</td> <td>\$59.45</td> </tr> <tr> <td>100+</td> <td>\$56.81</td> </tr> </tbody> </table> <p>75 Ohm SMB Plug to BNC Female Model No: <a href="#">PE9232</a></p>	PRICE		1-24	\$66.06	25-49	\$62.76	50-99	\$59.45	100+	\$56.81	 <table border="1"> <thead> <tr> <th colspan="2">PRICE</th> </tr> </thead> <tbody> <tr> <td>1-24</td> <td>\$63.51</td> </tr> <tr> <td>25-49</td> <td>\$60.33</td> </tr> <tr> <td>50-99</td> <td>\$57.16</td> </tr> <tr> <td>100+</td> <td>\$54.62</td> </tr> </tbody> </table> <p>75 Ohm SMB Plug to 75 Ohm Mini SMB Jack Max. Freq. 2 GHz Model No: <a href="#">PE9736</a></p>	PRICE		1-24	\$63.51	25-49	\$60.33	50-99	\$57.16	100+	\$54.62	 <table border="1"> <thead> <tr> <th colspan="2">PRICE</th> </tr> </thead> <tbody> <tr> <td>1-24</td> <td>\$62.40</td> </tr> <tr> <td>25-49</td> <td>\$59.28</td> </tr> <tr> <td>50-99</td> <td>\$56.16</td> </tr> <tr> <td>100+</td> <td>\$53.66</td> </tr> </tbody> </table> <p>75 Ohm SMB Jack to BNC Male Model No: <a href="#">PE9229</a></p>	PRICE		1-24	\$62.40	25-49	\$59.28	50-99	\$56.16	100+	\$53.66	 <table border="1"> <thead> <tr> <th colspan="2">PRICE</th> </tr> </thead> <tbody> <tr> <td>1-24</td> <td>\$71.18</td> </tr> <tr> <td>25-49</td> <td>\$67.62</td> </tr> <tr> <td>50-99</td> <td>\$64.06</td> </tr> <tr> <td>100+</td> <td>\$61.21</td> </tr> </tbody> </table> <p>75 Ohm SMB Jack to 75 Ohm Mini SMB Plug Model No: <a href="#">PE9735</a></p>	PRICE		1-24	\$71.18	25-49	\$67.62	50-99	\$64.06	100+	\$61.21	<p><b>75 Ohm SMC In-Series</b></p> 										
PRICE																																																							
1-24	\$66.06																																																						
25-49	\$62.76																																																						
50-99	\$59.45																																																						
100+	\$56.81																																																						
PRICE																																																							
1-24	\$63.51																																																						
25-49	\$60.33																																																						
50-99	\$57.16																																																						
100+	\$54.62																																																						
PRICE																																																							
1-24	\$62.40																																																						
25-49	\$59.28																																																						
50-99	\$56.16																																																						
100+	\$53.66																																																						
PRICE																																																							
1-24	\$71.18																																																						
25-49	\$67.62																																																						
50-99	\$64.06																																																						
100+	\$61.21																																																						



# ADAPTERS

See Adapter Locator on Pages 8-13

See Page 369 for Mounting Holes

	A	B	C	D	E																																								
1	 <table border="1"> <thead> <tr> <th colspan="2">PRICE</th> </tr> </thead> <tbody> <tr> <td>1-24</td> <td>\$38.72</td> </tr> <tr> <td>25-49</td> <td>\$36.78</td> </tr> <tr> <td>50-99</td> <td>\$34.85</td> </tr> <tr> <td>100+</td> <td>\$33.30</td> </tr> </tbody> </table> <p>75 Ohm SMC Plug to 75 Ohm SMC Plug</p> <p>Model No: <a href="#">PE9272</a></p>	PRICE		1-24	\$38.72	25-49	\$36.78	50-99	\$34.85	100+	\$33.30	 <table border="1"> <thead> <tr> <th colspan="2">PRICE</th> </tr> </thead> <tbody> <tr> <td>1-24</td> <td>\$56.49</td> </tr> <tr> <td>25-49</td> <td>\$53.67</td> </tr> <tr> <td>50-99</td> <td>\$50.84</td> </tr> <tr> <td>100+</td> <td>\$48.58</td> </tr> </tbody> </table> <p>75 Ohm SMC Jack to 75 Ohm SMC Plug Tee</p> <p>Model No: <a href="#">PE9244</a></p>	PRICE		1-24	\$56.49	25-49	\$53.67	50-99	\$50.84	100+	\$48.58	 <table border="1"> <thead> <tr> <th colspan="2">PRICE</th> </tr> </thead> <tbody> <tr> <td>1-24</td> <td>\$42.52</td> </tr> <tr> <td>25-49</td> <td>\$40.39</td> </tr> <tr> <td>50-99</td> <td>\$38.27</td> </tr> <tr> <td>100+</td> <td>\$36.57</td> </tr> </tbody> </table> <p>75 Ohm SMC Jack to 75 Ohm SMC Jack</p> <p>Model No: <a href="#">PE9227</a></p>	PRICE		1-24	\$42.52	25-49	\$40.39	50-99	\$38.27	100+	\$36.57	 <table border="1"> <thead> <tr> <th colspan="2">PRICE</th> </tr> </thead> <tbody> <tr> <td>1-24</td> <td>\$56.37</td> </tr> <tr> <td>25-49</td> <td>\$53.55</td> </tr> <tr> <td>50-99</td> <td>\$50.73</td> </tr> <tr> <td>100+</td> <td>\$48.48</td> </tr> </tbody> </table> <p>75 Ohm SMC Jack to 75 Ohm SMC Jack Bulkhead-Mounting Hole B03</p> <p>Model No: <a href="#">PE9228</a></p>	PRICE		1-24	\$56.37	25-49	\$53.55	50-99	\$50.73	100+	\$48.48	<p><b>75 Ohm SMC Between Series</b></p> <p>→</p>
	PRICE																																												
1-24	\$38.72																																												
25-49	\$36.78																																												
50-99	\$34.85																																												
100+	\$33.30																																												
PRICE																																													
1-24	\$56.49																																												
25-49	\$53.67																																												
50-99	\$50.84																																												
100+	\$48.58																																												
PRICE																																													
1-24	\$42.52																																												
25-49	\$40.39																																												
50-99	\$38.27																																												
100+	\$36.57																																												
PRICE																																													
1-24	\$56.37																																												
25-49	\$53.55																																												
50-99	\$50.73																																												
100+	\$48.48																																												
2	 <table border="1"> <thead> <tr> <th colspan="2">PRICE</th> </tr> </thead> <tbody> <tr> <td>1-24</td> <td>\$62.31</td> </tr> <tr> <td>25-49</td> <td>\$59.19</td> </tr> <tr> <td>50-99</td> <td>\$56.08</td> </tr> <tr> <td>100+</td> <td>\$53.59</td> </tr> </tbody> </table> <p>75 Ohm SMC Jack to BNC Female</p> <p>Model No: <a href="#">PE9235</a></p>	PRICE		1-24	\$62.31	25-49	\$59.19	50-99	\$56.08	100+	\$53.59	<p><b>75 Ohm TNC In-Series</b></p> <p>→</p>	 <table border="1"> <thead> <tr> <th colspan="2">PRICE</th> </tr> </thead> <tbody> <tr> <td>1-24</td> <td>\$96.05</td> </tr> <tr> <td>25-49</td> <td>\$91.25</td> </tr> <tr> <td>50-99</td> <td>\$86.45</td> </tr> <tr> <td>100+</td> <td>\$82.60</td> </tr> </tbody> </table> <p>75 Ohm TNC Male to 75 Ohm TNC Female Right Angle</p> <p>Model No: <a href="#">PE9623</a></p>	PRICE		1-24	\$96.05	25-49	\$91.25	50-99	\$86.45	100+	\$82.60	 <table border="1"> <thead> <tr> <th colspan="2">PRICE</th> </tr> </thead> <tbody> <tr> <td>1-24</td> <td>\$38.18</td> </tr> <tr> <td>25-49</td> <td>\$36.27</td> </tr> <tr> <td>50-99</td> <td>\$34.36</td> </tr> <tr> <td>100+</td> <td>\$32.83</td> </tr> </tbody> </table> <p>75 Ohm TNC Female to 75 Ohm TNC Female</p> <p>Max. Freq. 1,000 MHz</p> <p>Model No: <a href="#">PE9622</a></p>	PRICE		1-24	\$38.18	25-49	\$36.27	50-99	\$34.36	100+	\$32.83	 <table border="1"> <thead> <tr> <th colspan="2">PRICE</th> </tr> </thead> <tbody> <tr> <td>1-24</td> <td>\$53.27</td> </tr> <tr> <td>25-49</td> <td>\$50.61</td> </tr> <tr> <td>50-99</td> <td>\$47.94</td> </tr> <tr> <td>100+</td> <td>\$45.81</td> </tr> </tbody> </table> <p>75 Ohm TNC Female to 75 Ohm TNC Female Bulkhead-Mounting Hole B06</p> <p>Max. Freq. 1,000 MHz</p> <p>Model No: <a href="#">PE9625</a></p>	PRICE		1-24	\$53.27	25-49	\$50.61	50-99	\$47.94	100+	\$45.81
	PRICE																																												
1-24	\$62.31																																												
25-49	\$59.19																																												
50-99	\$56.08																																												
100+	\$53.59																																												
PRICE																																													
1-24	\$96.05																																												
25-49	\$91.25																																												
50-99	\$86.45																																												
100+	\$82.60																																												
PRICE																																													
1-24	\$38.18																																												
25-49	\$36.27																																												
50-99	\$34.36																																												
100+	\$32.83																																												
PRICE																																													
1-24	\$53.27																																												
25-49	\$50.61																																												
50-99	\$47.94																																												
100+	\$45.81																																												
3	 <table border="1"> <thead> <tr> <th colspan="2">PRICE</th> </tr> </thead> <tbody> <tr> <td>1-24</td> <td>\$90.90</td> </tr> <tr> <td>25-49</td> <td>\$86.36</td> </tr> <tr> <td>50-99</td> <td>\$81.81</td> </tr> <tr> <td>100+</td> <td>\$78.17</td> </tr> </tbody> </table> <p>75 Ohm TNC Female to 75 Ohm TNC Female Bulkhead</p> <p>Model No: <a href="#">PE9624</a></p>	PRICE		1-24	\$90.90	25-49	\$86.36	50-99	\$81.81	100+	\$78.17	<p><b>75 Ohm TNC Between Series</b></p> <p>→</p>	 <table border="1"> <thead> <tr> <th colspan="2">PRICE</th> </tr> </thead> <tbody> <tr> <td>1-24</td> <td>\$28.65</td> </tr> <tr> <td>25-49</td> <td>\$27.22</td> </tr> <tr> <td>50-99</td> <td>\$25.79</td> </tr> <tr> <td>100+</td> <td>\$24.64</td> </tr> </tbody> </table> <p>75 Ohm TNC Male to 75 Ohm BNC Female</p> <p>Max. Freq. 500 MHz</p> <p>Model No: <a href="#">PE9631</a></p>	PRICE		1-24	\$28.65	25-49	\$27.22	50-99	\$25.79	100+	\$24.64	 <table border="1"> <thead> <tr> <th colspan="2">PRICE</th> </tr> </thead> <tbody> <tr> <td>1-24</td> <td>\$80.60</td> </tr> <tr> <td>25-49</td> <td>\$76.57</td> </tr> <tr> <td>50-99</td> <td>\$72.54</td> </tr> <tr> <td>100+</td> <td>\$69.32</td> </tr> </tbody> </table> <p>75 Ohm TNC Male to 75 Ohm F Male</p> <p>VSWR 1.35:1 to 2 GHz</p> <p>Model No: <a href="#">PE91081</a></p>	PRICE		1-24	\$80.60	25-49	\$76.57	50-99	\$72.54	100+	\$69.32	 <table border="1"> <thead> <tr> <th colspan="2">PRICE</th> </tr> </thead> <tbody> <tr> <td>1-24</td> <td>\$71.66</td> </tr> <tr> <td>25-49</td> <td>\$68.08</td> </tr> <tr> <td>50-99</td> <td>\$64.49</td> </tr> <tr> <td>100+</td> <td>\$61.63</td> </tr> </tbody> </table> <p>75 Ohm TNC Male to 75 Ohm F Female</p> <p>VSWR 1.35:1 to 2 GHz</p> <p>Model No: <a href="#">PE91080</a></p>	PRICE		1-24	\$71.66	25-49	\$68.08	50-99	\$64.49	100+	\$61.63
	PRICE																																												
1-24	\$90.90																																												
25-49	\$86.36																																												
50-99	\$81.81																																												
100+	\$78.17																																												
PRICE																																													
1-24	\$28.65																																												
25-49	\$27.22																																												
50-99	\$25.79																																												
100+	\$24.64																																												
PRICE																																													
1-24	\$80.60																																												
25-49	\$76.57																																												
50-99	\$72.54																																												
100+	\$69.32																																												
PRICE																																													
1-24	\$71.66																																												
25-49	\$68.08																																												
50-99	\$64.49																																												
100+	\$61.63																																												
4	 <table border="1"> <thead> <tr> <th colspan="2">PRICE</th> </tr> </thead> <tbody> <tr> <td>1-24</td> <td>\$53.27</td> </tr> <tr> <td>25-49</td> <td>\$50.61</td> </tr> <tr> <td>50-99</td> <td>\$47.94</td> </tr> <tr> <td>100+</td> <td>\$45.81</td> </tr> </tbody> </table> <p>75 Ohm TNC Female to 75 Ohm BNC Male</p> <p>Max. Freq. 1,000 MHz</p> <p>Model No: <a href="#">PE9630</a></p>	PRICE		1-24	\$53.27	25-49	\$50.61	50-99	\$47.94	100+	\$45.81	 <table border="1"> <thead> <tr> <th colspan="2">PRICE</th> </tr> </thead> <tbody> <tr> <td>1-24</td> <td>\$96.45</td> </tr> <tr> <td>25-49</td> <td>\$91.63</td> </tr> <tr> <td>50-99</td> <td>\$86.81</td> </tr> <tr> <td>100+</td> <td>\$82.95</td> </tr> </tbody> </table> <p>75 Ohm TNC Female to 75 Ohm F Male</p> <p>VSWR 1.35:1 to 2 GHz</p> <p>Model No: <a href="#">PE91083</a></p>	PRICE		1-24	\$96.45	25-49	\$91.63	50-99	\$86.81	100+	\$82.95	 <table border="1"> <thead> <tr> <th colspan="2">PRICE</th> </tr> </thead> <tbody> <tr> <td>1-24</td> <td>\$80.61</td> </tr> <tr> <td>25-49</td> <td>\$77.39</td> </tr> <tr> <td>50-99</td> <td>\$74.97</td> </tr> <tr> <td>100+</td> <td>\$73.36</td> </tr> </tbody> </table> <p>75 Ohm TNC Female to 75 Ohm F Female</p> <p>VSWR 1.35:1 to 2 GHz</p> <p>Model No: <a href="#">PE91082</a></p>	PRICE		1-24	\$80.61	25-49	\$77.39	50-99	\$74.97	100+	\$73.36	<p><b>BNC Twinax In-Series</b></p> <p>→</p>	 <table border="1"> <thead> <tr> <th colspan="2">PRICE</th> </tr> </thead> <tbody> <tr> <td>1-24</td> <td>\$85.44</td> </tr> <tr> <td>25-49</td> <td>\$81.17</td> </tr> <tr> <td>50-99</td> <td>\$76.90</td> </tr> <tr> <td>100+</td> <td>\$73.48</td> </tr> </tbody> </table> <p>78 Ohm BNC Twinax Plug to 78 Ohm BNC Twinax Plug</p> <p>Model No: <a href="#">PE9376</a></p>	PRICE		1-24	\$85.44	25-49	\$81.17	50-99	\$76.90	100+	\$73.48
	PRICE																																												
1-24	\$53.27																																												
25-49	\$50.61																																												
50-99	\$47.94																																												
100+	\$45.81																																												
PRICE																																													
1-24	\$96.45																																												
25-49	\$91.63																																												
50-99	\$86.81																																												
100+	\$82.95																																												
PRICE																																													
1-24	\$80.61																																												
25-49	\$77.39																																												
50-99	\$74.97																																												
100+	\$73.36																																												
PRICE																																													
1-24	\$85.44																																												
25-49	\$81.17																																												
50-99	\$76.90																																												
100+	\$73.48																																												
5	 <table border="1"> <thead> <tr> <th colspan="2">PRICE</th> </tr> </thead> <tbody> <tr> <td>1-24</td> <td>\$84.88</td> </tr> <tr> <td>25-49</td> <td>\$80.64</td> </tr> <tr> <td>50-99</td> <td>\$76.39</td> </tr> <tr> <td>100+</td> <td>\$73.00</td> </tr> </tbody> </table> <p>78 Ohm BNC Twinax Plug to 78 Ohm BNC Twinax Jack Right Angle</p> <p>Model No: <a href="#">PE9377</a></p>	PRICE		1-24	\$84.88	25-49	\$80.64	50-99	\$76.39	100+	\$73.00	 <table border="1"> <thead> <tr> <th colspan="2">PRICE</th> </tr> </thead> <tbody> <tr> <td>1-24</td> <td>\$84.49</td> </tr> <tr> <td>25-49</td> <td>\$80.27</td> </tr> <tr> <td>50-99</td> <td>\$76.04</td> </tr> <tr> <td>100+</td> <td>\$72.66</td> </tr> </tbody> </table> <p>78 Ohm BNC Twinax Jack to 78 Ohm BNC Twinax Plug Tee</p> <p>Model No: <a href="#">PE9375</a></p>	PRICE		1-24	\$84.49	25-49	\$80.27	50-99	\$76.04	100+	\$72.66	 <table border="1"> <thead> <tr> <th colspan="2">PRICE</th> </tr> </thead> <tbody> <tr> <td>1-24</td> <td>\$37.93</td> </tr> <tr> <td>25-49</td> <td>\$36.03</td> </tr> <tr> <td>50-99</td> <td>\$34.14</td> </tr> <tr> <td>100+</td> <td>\$32.62</td> </tr> </tbody> </table> <p>78 Ohm BNC Twinax Jack to 78 Ohm BNC Twinax Jack</p> <p>Max. Freq. 500 MHz</p> <p>Model No: <a href="#">PE9378</a></p>	PRICE		1-24	\$37.93	25-49	\$36.03	50-99	\$34.14	100+	\$32.62	 <table border="1"> <thead> <tr> <th colspan="2">PRICE</th> </tr> </thead> <tbody> <tr> <td>1-24</td> <td>\$47.69</td> </tr> <tr> <td>25-49</td> <td>\$45.31</td> </tr> <tr> <td>50-99</td> <td>\$42.92</td> </tr> <tr> <td>100+</td> <td>\$41.01</td> </tr> </tbody> </table> <p>78 Ohm BNC Twinax Jack to 78 Ohm BNC Twinax Jack Bulkhead</p> <p>Max. Freq. 500 MHz</p> <p>Model No: <a href="#">PE9280</a></p>	PRICE		1-24	\$47.69	25-49	\$45.31	50-99	\$42.92	100+	\$41.01	<p><b>3/4"-20 Twinax In-Series</b></p> <p>→</p>
	PRICE																																												
1-24	\$84.88																																												
25-49	\$80.64																																												
50-99	\$76.39																																												
100+	\$73.00																																												
PRICE																																													
1-24	\$84.49																																												
25-49	\$80.27																																												
50-99	\$76.04																																												
100+	\$72.66																																												
PRICE																																													
1-24	\$37.93																																												
25-49	\$36.03																																												
50-99	\$34.14																																												
100+	\$32.62																																												
PRICE																																													
1-24	\$47.69																																												
25-49	\$45.31																																												
50-99	\$42.92																																												
100+	\$41.01																																												
6	 <table border="1"> <thead> <tr> <th colspan="2">PRICE</th> </tr> </thead> <tbody> <tr> <td>1-24</td> <td>\$40.23</td> </tr> <tr> <td>25-49</td> <td>\$38.22</td> </tr> <tr> <td>50-99</td> <td>\$36.21</td> </tr> <tr> <td>100+</td> <td>\$34.60</td> </tr> </tbody> </table> <p>95 Ohm 3/4"-20 Twinax Female to 95 Ohm 3/4"-20 Twinax Male Tee</p> <p>Max. Freq. 400 MHz</p> <p>Model No: <a href="#">PE9374</a></p>	PRICE		1-24	\$40.23	25-49	\$38.22	50-99	\$36.21	100+	\$34.60	 <table border="1"> <thead> <tr> <th colspan="2">PRICE</th> </tr> </thead> <tbody> <tr> <td>1-24</td> <td>\$30.20</td> </tr> <tr> <td>25-49</td> <td>\$28.69</td> </tr> <tr> <td>50-99</td> <td>\$27.18</td> </tr> <tr> <td>100+</td> <td>\$25.97</td> </tr> </tbody> </table> <p>95 Ohm 3/4"-20 Twinax Female to 95 Ohm 3/4"-20 Twinax Female</p> <p>Model No: <a href="#">PE9199</a></p>	PRICE		1-24	\$30.20	25-49	\$28.69	50-99	\$27.18	100+	\$25.97	 <table border="1"> <thead> <tr> <th colspan="2">PRICE</th> </tr> </thead> <tbody> <tr> <td>1-24</td> <td>\$53.22</td> </tr> <tr> <td>25-49</td> <td>\$50.56</td> </tr> <tr> <td>50-99</td> <td>\$47.90</td> </tr> <tr> <td>100+</td> <td>\$45.77</td> </tr> </tbody> </table> <p>95 Ohm 3/4"-20 Twinax Female to 95 Ohm 3/4"-20 Twinax Female Tee</p> <p>Model No: <a href="#">PE9224</a></p>	PRICE		1-24	\$53.22	25-49	\$50.56	50-99	\$47.90	100+	\$45.77	 <table border="1"> <thead> <tr> <th colspan="2">PRICE</th> </tr> </thead> <tbody> <tr> <td>1-24</td> <td>\$52.18</td> </tr> <tr> <td>25-49</td> <td>\$49.57</td> </tr> <tr> <td>50-99</td> <td>\$46.96</td> </tr> <tr> <td>100+</td> <td>\$44.87</td> </tr> </tbody> </table> <p>95 Ohm 3/4"-20 Twinax Female to 95 Ohm 3/4"-20 Twinax Female Bulkhead</p> <p>Model No: <a href="#">PE9373</a></p>	PRICE		1-24	\$52.18	25-49	\$49.57	50-99	\$46.96	100+	\$44.87	<p><b>Banana Between Series</b></p> <p>→</p>
	PRICE																																												
1-24	\$40.23																																												
25-49	\$38.22																																												
50-99	\$36.21																																												
100+	\$34.60																																												
PRICE																																													
1-24	\$30.20																																												
25-49	\$28.69																																												
50-99	\$27.18																																												
100+	\$25.97																																												
PRICE																																													
1-24	\$53.22																																												
25-49	\$50.56																																												
50-99	\$47.90																																												
100+	\$45.77																																												
PRICE																																													
1-24	\$52.18																																												
25-49	\$49.57																																												
50-99	\$46.96																																												
100+	\$44.87																																												
7	 <table border="1"> <thead> <tr> <th colspan="2">PRICE</th> </tr> </thead> <tbody> <tr> <td>1-24</td> <td>\$47.64</td> </tr> <tr> <td>25-49</td> <td>\$45.26</td> </tr> <tr> <td>50-99</td> <td>\$42.88</td> </tr> <tr> <td>100+</td> <td>\$40.97</td> </tr> </tbody> </table> <p>Banana Plug to BNC Female</p> <p>Model No: <a href="#">PE9175</a></p>	PRICE		1-24	\$47.64	25-49	\$45.26	50-99	\$42.88	100+	\$40.97	<p><b>Non Constant Ohm BNC Triax In-Series</b></p> <p>→</p>	 <table border="1"> <thead> <tr> <th colspan="2">PRICE</th> </tr> </thead> <tbody> <tr> <td>1-9</td> <td>\$144.11</td> </tr> <tr> <td>10-24</td> <td>\$136.90</td> </tr> <tr> <td>25-49</td> <td>\$129.70</td> </tr> <tr> <td>50+</td> <td>\$123.93</td> </tr> </tbody> </table> <p>BNC Triax Male to BNC Triax Female Tee</p> <p>Max. Freq. 500 MHz</p> <p>Model No: <a href="#">PE91106</a></p>	PRICE		1-9	\$144.11	10-24	\$136.90	25-49	\$129.70	50+	\$123.93	 <table border="1"> <thead> <tr> <th colspan="2">PRICE</th> </tr> </thead> <tbody> <tr> <td>1-24</td> <td>\$39.74</td> </tr> <tr> <td>25-49</td> <td>\$37.75</td> </tr> <tr> <td>50-99</td> <td>\$35.77</td> </tr> <tr> <td>100+</td> <td>\$34.18</td> </tr> </tbody> </table> <p>BNC Triax Female to BNC Triax Female</p> <p>Max. Freq. 500 MHz</p> <p>Model No: <a href="#">PE91107</a></p>	PRICE		1-24	\$39.74	25-49	\$37.75	50-99	\$35.77	100+	\$34.18	 <table border="1"> <thead> <tr> <th colspan="2">PRICE</th> </tr> </thead> <tbody> <tr> <td>1-9</td> <td>\$146.82</td> </tr> <tr> <td>10-24</td> <td>\$139.48</td> </tr> <tr> <td>25-49</td> <td>\$132.14</td> </tr> <tr> <td>50+</td> <td>\$126.27</td> </tr> </tbody> </table> <p>BNC Triax Female to BNC Triax Female Bulkhead-Mounting Hole B15</p> <p>Max. Freq. 500 MHz</p> <p>Model No: <a href="#">PE91105</a></p>	PRICE		1-9	\$146.82	10-24	\$139.48	25-49	\$132.14	50+	\$126.27
	PRICE																																												
1-24	\$47.64																																												
25-49	\$45.26																																												
50-99	\$42.88																																												
100+	\$40.97																																												
PRICE																																													
1-9	\$144.11																																												
10-24	\$136.90																																												
25-49	\$129.70																																												
50+	\$123.93																																												
PRICE																																													
1-24	\$39.74																																												
25-49	\$37.75																																												
50-99	\$35.77																																												
100+	\$34.18																																												
PRICE																																													
1-9	\$146.82																																												
10-24	\$139.48																																												
25-49	\$132.14																																												
50+	\$126.27																																												



Technical Support  
+1 (949) 261-1920



Same-Day Shipping,  
Even Custom Cable Assemblies

# Amplifiers Selection Guide

## 3 Easy Ways to Find your Product.....

### 1. Search by PE Part Number

If you know the PE part number you are searching for, please reference our Part Number Index on Page [355](#).

### 2. Quick Reference Guide

Bi Directional Amplifiers.....	<a href="#">48</a>
Broadband Amplifiers.....	<a href="#">48</a>
USB Controlled.....	<a href="#">49</a>
Bench Top.....	<a href="#">50</a>
DC Coupled Amplifiers.....	<a href="#">50</a>
Gain Block Amplifiers.....	<a href="#">50</a>
Limiting Amplifiers.....	<a href="#">50</a>
Log Amplifiers.....	<a href="#">51</a>
Low Noise Amplifiers.....	<a href="#">51</a>
Standard.....	<a href="#">51</a>
Input Protected.....	<a href="#">52</a>
Power Amplifiers.....	<a href="#">53</a>
Power Amplifiers (<4W).....	<a href="#">53</a>
High Power Amplifiers (>4W).....	<a href="#">54</a>
GaN High Power Amplifiers.....	<a href="#">55</a>
Variable Amplifiers.....	<a href="#">56</a>
Amplifier Accessories.....	<a href="#">56</a>

### 3. Amplifiers Locator

Frequency	Model No.	Page C/R	Frequency	Model No.	Page C/R	Frequency	Model No.	Page C/R	Frequency	Model No.	Page C/R	
<b>DC to:</b>			<b>10 MHz to:</b>			<b>20 MHz to:</b>			<b>100 MHz to:</b>			
17 MHz	<a href="#">PE15A86002</a>	50 42	550 MHz	<a href="#">PE15A1044</a>	51 62	3 GHz	<a href="#">PE15A1008</a>	51 76	18 GHz	<a href="#">PE15A3255</a>	49 63	
1.5 GHz	<a href="#">PE15A86001</a>	50 43	600 MHz	<a href="#">PE15A1063</a>	51 63	4 GHz	<a href="#">PE15A4017</a>	53 41		<a href="#">PE15A3256</a>	49 64	
2 GHz	<a href="#">PE15A86000</a>	50 44	800 MHz	<a href="#">PE15A1048</a>	51 64	4 GHz	<a href="#">PE15A1061</a>	51 77		<a href="#">PE15A4052</a>	53 45	
<b>0.009 MHz to:</b>				<a href="#">PE15A1065</a>	51 65	<b>30 MHz to:</b>				<a href="#">PE15A4052F</a>	53 46	
3 GHz	<a href="#">PE15A1007</a>	51 55		<a href="#">PE15A1011</a>	51 66	1.5 GHz	<a href="#">PE15A63002</a>	52 21	26.5 GHz	<a href="#">PE15A7000</a>	56 82	
<b>0.01 MHz to:</b>				<a href="#">PE15A1049</a>	51 67	2.5 GHz	<a href="#">PE15A63003</a>	52 22	<a href="#">PE15A3267</a>	49 65		
500 MHz	<a href="#">PE15A1046</a>	51 56	1 GHz	<a href="#">PE15A1012</a>	51 68	2.7 GHz	<a href="#">PE15A5011</a>	55 58	<a href="#">PE15A3280</a>	49 66		
1.4 GHz	<a href="#">PE15A1055</a>	51 57			<a href="#">PE15A1013</a>	51 69	3 GHz	<a href="#">PE15B5003</a>	48 1	<a href="#">PE15A3281</a>	49 67	
2 GHz	<a href="#">PE15A1059</a>	51 58			<a href="#">PE15A1052</a>	51 70	20 GHz	<a href="#">PE15A4018</a>	53 42	<a href="#">PE15A3282</a>	49 68	
3 GHz	<a href="#">PE15A3308</a>	49 56			<a href="#">PE15A63000</a>	52 19	40 GHz	<a href="#">PE15A3254</a>	49 62	<a href="#">PE15A3283</a>	49 69	
<b>0.03 MHz to:</b>					<a href="#">PE15A63001</a>	52 20	<b>40 MHz to:</b>			<a href="#">PE15A3284</a>	49 70	
600 MHz	<a href="#">PE15A1047</a>	51 59	1.3 GHz	<a href="#">PE15A1054</a>	51 71	3 GHz	<a href="#">PE15A1060</a>	51 78	<a href="#">PE15A3285</a>	49 71		
<b>0.1 MHz to:</b>				<a href="#">PE1514</a>	50 23	<b>50 MHz to:</b>			<a href="#">PE15A3286</a>	49 72		
10 GHz	<a href="#">PE15A3311</a>	49 57	3 GHz	<a href="#">PE1528</a>	50 24	1 GHz	<a href="#">PE1517</a>	50 27	<a href="#">PE15A3287</a>	49 73		
<b>0.15 MHz to:</b>					<a href="#">PE1513</a>		50 25	<a href="#">PE15A9001</a>	51 79	<a href="#">PE15A3288</a>	49 74	
230 MHz	<a href="#">PE15A5028</a>	54 10			<a href="#">PE15A1009</a>		51 72	<a href="#">PE15A1050</a>	51 80	<a href="#">PE15A3289</a>	49 75	
6.5 GHz	<a href="#">PE15A5028F</a>	54 11	6 GHz	<a href="#">PE15A4032</a>	48 4	1.2 GHz	<a href="#">PE15A1014</a>	51 81	<b>110 MHz to:</b>			
<b>0.3 MHz to:</b>				<a href="#">PE15A8001</a>	50 26	2 GHz	<a href="#">PE15A4009</a>	53 43	6 GHz	<a href="#">PE15A3004</a>	48 9	
500 MHz	<a href="#">PE15A5029</a>	54 12	15 GHz	<a href="#">PE15A3037</a>	50 10	4 GHz	<a href="#">PE15A1053</a>	51 82	10 GHz	<a href="#">PE15A3001</a>	48 10	
500 MHz	<a href="#">PE15A5029F</a>	54 13			<a href="#">PE15A3036</a>	48 5	18 GHz	<a href="#">PE1518</a>	50 28	<b>200 MHz to:</b>		
<b>1 MHz to:</b>				<a href="#">PE15A4029</a>	48 6	40 GHz	<a href="#">PE15A1042</a>	51 83	2.5 GHz	<a href="#">PE1525</a>	50 31	
500 MHz	<a href="#">PE15A1045</a>	51 60	20 MHz to:	<a href="#">PE15A3272</a>	49 61	6 GHz	<a href="#">PE15A8000</a>	50 29	2.6 GHz	<a href="#">PE15A5084</a>	53 47	
1 GHz	<a href="#">PE15A5030</a>	53 34		520 MHz	<a href="#">PE15A5065</a>	53 38	18 GHz	<a href="#">PE15A3900</a>	49 8	<b>300 MHz to:</b>		
1 GHz	<a href="#">PE15A5030F</a>	53 35	1 GHz	<a href="#">PE15A1051</a>	51 73	40 GHz	<a href="#">PE15A3901</a>	49 9	18 GHz	<a href="#">PE15A3021</a>	48 11	
3 GHz	<a href="#">PE15A3309</a>	49 59			<a href="#">PE15A1064</a>	51 74	<b>60 MHz to:</b>			<a href="#">PE15A3021D</a>	48 12	
<b>1.5 MHz to:</b>					<a href="#">PE15A5031</a>	54 14	6 GHz	<a href="#">PE15A4019</a>	53 44	<b>500 MHz to:</b>		
30 MHz	<a href="#">PE15A5055</a>	53 36			<a href="#">PE15A5031F</a>	54 15	100 MHz to:			1 GHz	<a href="#">PE15A5058</a>	53 48
100 MHz	<a href="#">PE15A5056</a>	53 37			<a href="#">PE15A4072</a>	53 39	2 GHz	<a href="#">PE15A1066</a>	51 84	1 GHz	<a href="#">PE15A4038</a>	48 13
<b>10 MHz to:</b>				<a href="#">PE15A5057</a>	53 40	3 GHz	<a href="#">PE1516</a>	50 30	2 GHz	<a href="#">PE15A3014</a>	48 14	
250 MHz	<a href="#">PE15A1043</a>	51 61	1.5 GHz	<a href="#">PE15A1057</a>	51 75	6 GHz	<a href="#">PE15A5027</a>	56 59	2 GHz	<a href="#">PE15A3015</a>	48 15	
						12 GHz	<a href="#">PE15A3007</a>	48 8	2 GHz	<a href="#">PE15A8004</a>	50 32	
									2 GHz	<a href="#">PE15A8005</a>	50 33	

# Amplifiers Locator

Frequency	Model No.	Page C/R
<b>500 MHz to:</b>		
2.5 GHz	<a href="#">PE15A4039</a>	48 16
	<a href="#">PE15A5059</a>	56 60
	<a href="#">PE15A5060</a>	56 61
2.8 GHz	<a href="#">PE15A5013</a>	54 16
	<a href="#">PE15A1017</a>	51 85
3 GHz	<a href="#">PE15A1018</a>	51 86
	<a href="#">PE15A5032</a>	56 62
	<a href="#">PE15A5032F</a>	56 63
	<a href="#">PE15A2000</a>	51 50
4 GHz	<a href="#">PE15A1068</a>	51 87
	<a href="#">PE15A4053</a>	53 49
	<a href="#">PE15A4053F</a>	53 50
6 GHz	<a href="#">PE15A4037</a>	48 17
10 GHz	<a href="#">PE15A3005</a>	48 18
	<a href="#">PE15A3008</a>	48 19
18 GHz	<a href="#">PE15A3263</a>	48 20
	<a href="#">PE15A2003</a>	51 51
20 GHz	<a href="#">PE15A3253</a>	49 76
<b>700 MHz to:</b>		
2.2 GHz	<a href="#">PE15A5004</a>	54 17
	<a href="#">PE15A1067</a>	51 88
	<a href="#">PE15A5033</a>	56 64
2.7 GHz	<a href="#">PE15A5033F</a>	56 65
	<a href="#">PE15A5017</a>	56 66
6 GHz	<a href="#">PE15A5017</a>	56 66
	<a href="#">PE15A5017</a>	56 66
<b>800 MHz to:</b>		
960 MHz	<a href="#">PE15A5040</a>	54 18
	<a href="#">PE15A5041</a>	54 19
1 GHz	<a href="#">PE15A5061</a>	53 21
	<a href="#">PE15A5035</a>	55 50
2 GHz	<a href="#">PE15A5035F</a>	55 21
	<a href="#">PE15A5077</a>	53 52
2.5 GHz	<a href="#">PE15A5020</a>	55 22
	<a href="#">PE15A5062</a>	56 67
4.2 GHz	<a href="#">PE15A5034F</a>	53 53
	<a href="#">PE15A5034</a>	53 54
5.5 GHz	<a href="#">PE15A3264</a>	48 21
<b>820 MHz to:</b>		
960 MHz	<a href="#">PE15A4026</a>	53 55
<b>860 MHz to:</b>		
960 MHz	<a href="#">PE15A5042</a>	55 23
	<a href="#">PE15A5039</a>	55 24
<b>900 MHz to:</b>		
1.2 GHz	<a href="#">PE15A63004</a>	52 23
	<a href="#">PE15A63005</a>	52 24
<b>1 GHz to:</b>		
1.4 GHz	<a href="#">PE15A63006</a>	52 25
	<a href="#">PE15A6002</a>	50 45
2 GHz	<a href="#">PE15A1000</a>	51 89
	<a href="#">PE15A1019</a>	52 90
	<a href="#">PE15A5063</a>	56 68
	<a href="#">PE15A4025</a>	53 56
	<a href="#">PE15A4016</a>	53 57
	<a href="#">PE15A5036F</a>	55 25
2.5 GHz	<a href="#">PE15A5036</a>	55 26
	<a href="#">PE15A5082</a>	55 27
	<a href="#">PE15A5081</a>	55 28
	<a href="#">PE15A5085</a>	53 58
	<a href="#">PE15A5083</a>	53 59
	<a href="#">PE15A5026</a>	56 69
3 GHz	<a href="#">PE15A5037</a>	55 29
	<a href="#">PE15A5037F</a>	55 30
4 GHz	<a href="#">PE1519</a>	50 34
	<a href="#">PE15A1070</a>	52 91
7 GHz	<a href="#">PE15A1075</a>	52 26
12 GHz	<a href="#">PE15A1031</a>	52 92
18 GHz	<a href="#">PE15A3262</a>	48 22
20 GHz	<a href="#">PE15A3500</a>	50 11
	<a href="#">PE15A3512</a>	50 12
20 GHz	<a href="#">PE15A3513</a>	50 13
	<a href="#">PE15A3278</a>	49 77
23 GHz	<a href="#">PE15A1074</a>	52 27
40 GHz	<a href="#">PE15A3514</a>	50 14
	<a href="#">PE15A3515</a>	50 15
<b>1.2 GHz to:</b>		
1.4 GHz	<a href="#">PE15A1023</a>	52 93
	<a href="#">PE15A1024</a>	52 94
	<a href="#">PE15A1005</a>	52 95

Frequency	Model No.	Page C/R
<b>1.2 GHz to:</b>		
1.4 GHz	<a href="#">PE15A5001</a>	55 31
	<a href="#">PE15A4010</a>	53 60
1.6 GHz	<a href="#">PE15A1028</a>	52 96
	<a href="#">PE15A5064</a>	56 70
<b>1.215 GHz to:</b>		
1.4 GHz	<a href="#">PE15A1039</a>	52 97
	<a href="#">PE15A1040</a>	52 98
<b>1.35 GHz to:</b>		
1.39 GHz	<a href="#">PE15B5001</a>	48 2
<b>1.5 GHz to:</b>		
3.5 GHz	<a href="#">PE15A5005</a>	55 32
5 GHz	<a href="#">PE15A1034</a>	52 99
<b>1.7 GHz to:</b>		
2 GHz	<a href="#">PE15A5014</a>	55 33
2.4 GHz	<a href="#">PE15A5073</a>	55 34
2.5 GHz	<a href="#">PE15A5015</a>	55 35
<b>1.8 GHz to:</b>		
4.2 GHz	<a href="#">PE15A3276</a>	49 78
<b>2 GHz to:</b>		
2.6 GHz	<a href="#">PE15A63007</a>	52 28
	<a href="#">PE15A5074</a>	53 61
4 GHz	<a href="#">PE1520</a>	50 35
	<a href="#">PE15A6015</a>	51 46
	<a href="#">PE15A1001</a>	52 1
	<a href="#">PE15A5038</a>	55 36
	<a href="#">PE15A5038F</a>	55 37
	<a href="#">PE15A4011</a>	53 62
4.4 GHz	<a href="#">PE15A4040</a>	48 23
	<a href="#">PE15A4041</a>	48 24
	<a href="#">PE15A4003</a>	48 25
	<a href="#">PE15A4005</a>	48 26
	<a href="#">PE15A4042</a>	48 27
	<a href="#">PE15A4043</a>	48 28
	<a href="#">PE15A3503</a>	48 51
	<a href="#">PE15A3504</a>	48 52
	<a href="#">PE15A3277</a>	49 79
	<a href="#">PE1521</a>	50 36
	<a href="#">PE15A6007</a>	51 47
	<a href="#">PE15A2001</a>	51 52
6 GHz	<a href="#">PE15A1010</a>	52 2
	<a href="#">PE15A5066</a>	56 71
	<a href="#">PE15A5067</a>	56 72
	<a href="#">PE15A5024</a>	56 73
	<a href="#">PE15A5025</a>	56 74
	<a href="#">PE15A5047</a>	55 38
	<a href="#">PE15A5047F</a>	55 39
	<a href="#">PE15A3016</a>	48 29
	<a href="#">PE15A3290</a>	49 80
	<a href="#">PE15A3291</a>	49 81
	<a href="#">PE15A6008</a>	51 48
	<a href="#">PE15A4054</a>	53 63
12 GHz	<a href="#">PE15A4054F</a>	53 64
	<a href="#">PE15A4055</a>	53 65
	<a href="#">PE15A4055F</a>	53 66
	<a href="#">PE15A4051</a>	48 30
	<a href="#">PE15A3265</a>	48 31
	<a href="#">PE15A3022</a>	48 32
	<a href="#">PE15A3301</a>	49 82
	<a href="#">PE15A3257</a>	49 83
	<a href="#">PE15A3258</a>	49 84
	<a href="#">PE1524</a>	50 37
	<a href="#">PE15A1030</a>	52 3
	18 GHz	<a href="#">PE15A5068</a>
<a href="#">PE15A4056</a>		53 67
<a href="#">PE15A4056F</a>		53 68
<a href="#">PE15A4057</a>		53 69
<a href="#">PE15A4057F</a>		53 70
<a href="#">PE15A4027</a>		48 33
<a href="#">PE15A4030</a>		48 34
<a href="#">PE15A3271</a>		49 85
<a href="#">PE15A3270</a>		49 86
<a href="#">PE15A4058</a>		53 71
<a href="#">PE15A4058F</a>		53 72
24 GHz		<a href="#">PE15A3009</a>
35 GHz	<a href="#">PE15A3038</a>	48 36
<b>2.2 GHz to:</b>		
2.7 GHz	<a href="#">PE15A5022</a>	53 73

Frequency	Model No.	Page C/R
<b>2.3 GHz to:</b>		
2.7 GHz	<a href="#">PE15A5018</a>	55 40
<b>2.4 GHz to:</b>		
2.5 GHz	<a href="#">PE15B5000</a>	48 3
<b>2.5 GHz to:</b>		
4 GHz	<a href="#">PE15A5006</a>	55 41
<b>2.6 GHz to:</b>		
3.1 GHz	<a href="#">PE15A63008</a>	52 29
	<a href="#">PE15A63009</a>	52 30
4.2 GHz	<a href="#">PE15A5007</a>	55 42
<b>3 GHz to:</b>		
8 GHz	<a href="#">PE15A1035</a>	52 4
<b>3.1 GHz to:</b>		
3.5 GHz	<a href="#">PE15A4046</a>	48 37
	<a href="#">PE15A1006</a>	52 5
	<a href="#">PE15A63010</a>	52 31
	<a href="#">PE15A63011</a>	52 32
	<a href="#">PE15A5023</a>	55 43
	<a href="#">PE15A5003</a>	55 44
<a href="#">PE15A5002</a>	53 74	
<b>3.5 GHz to:</b>		
7 GHz	<a href="#">PE15A5008</a>	55 45
	<a href="#">PE15A4012</a>	53 75
<b>4 GHz to:</b>		
8 GHz	<a href="#">PE1522</a>	50 38
	<a href="#">PE15A1002</a>	52 6
<b>4.4 GHz to:</b>		
4.9 GHz	<a href="#">PE15A5079</a>	53 76
	<a href="#">PE15A5080</a>	53 77
<b>5 GHz to:</b>		
9 GHz	<a href="#">PE15A9002</a>	52 7
13 GHz	<a href="#">PE15A1073</a>	52 33
<b>5.5 GHz to:</b>		
9.5 GHz	<a href="#">PE15A5009</a>	55 46
<b>6 GHz to:</b>		
10 GHz	<a href="#">PE15A5069</a>	56 76
	<a href="#">PE15A4044</a>	48 38
	<a href="#">PE15A4045</a>	48 39
	<a href="#">PE15A4001</a>	48 40
	<a href="#">PE15A4004</a>	48 41
	<a href="#">PE15A3506</a>	48 53
	<a href="#">PE15A3505</a>	48 54
	<a href="#">PE15A3292</a>	49 87
	<a href="#">PE15A3293</a>	49 88
	<a href="#">PE15A8006</a>	50 39
	<a href="#">PE15A1032</a>	52 8
	<a href="#">PE15A1072</a>	52 9
<a href="#">PE15A4060</a>	53 78	
<a href="#">PE15A4060F</a>	54 79	
12 GHz	<a href="#">PE15A3018</a>	48 42
	<a href="#">PE15A3019</a>	48 43
	<a href="#">PE15A3017</a>	48 44
	<a href="#">PE15A3020</a>	48 45
	<a href="#">PE15A3295</a>	49 89
	<a href="#">PE15A3294</a>	49 90
	<a href="#">PE15A3302</a>	49 91
	<a href="#">PE15A3259</a>	49 92
	<a href="#">PE15A8007</a>	50 40
	<a href="#">PE1523</a>	50 41
	<a href="#">PE15A6012</a>	51 49
	<a href="#">PE15A2002</a>	51 53
18 GHz	<a href="#">PE15A2004</a>	51 54
	<a href="#">PE15A1071</a>	52 10
	<a href="#">PE15A5070</a>	56 77
	<a href="#">PE15A5050</a>	55 47
	<a href="#">PE15A5050F</a>	55 48
	<a href="#">PE15A5049</a>	55 49
	<a href="#">PE15A5049F</a>	55 50
	<a href="#">PE15A4061F</a>	54 80
	<a href="#">PE15A4061</a>	54 81
	<a href="#">PE15A5048</a>	54 82
	<a href="#">PE15A5048F</a>	54 83
	<a href="#">PE15A4062</a>	54 84
<a href="#">PE15A4062F</a>	54 85	
<b>6.4 GHz to:</b>		
7.1 GHz	<a href="#">PE15A5016</a>	56 78
<b>7 GHz to:</b>		
11 GHz	<a href="#">PE15A1033</a>	52 11
17 GHz	<a href="#">PE15A3273</a>	49 93

Frequency	Model No.	Page C/R	
<b>7.2 GHz to:</b>			
7.5 GHz	<a href="#">PE15A5019</a>	56 79	
<b>7.5 GHz to:</b>			
11 GHz	<a href="#">PE15A4013</a>	54 86	
<b>8 GHz to:</b>			
11 GHz	<a href="#">PE15A4014</a>	54 87	
	<a href="#">PE15A4015</a>	54 88	
	<a href="#">PE15A1027</a>	52 12	
	<a href="#">PE15A1026</a>	52 13	
	<a href="#">PE15A1003M</a>	52 14	
	<a href="#">PE15A1003</a>	52 15	
12 GHz	<a href="#">PE15A1025</a>	52 16	
	<a href="#">PE15A5071</a>	56 80	
	<a href="#">PE15A5072</a>	56 81	
	<a href="#">PE15A5053</a>	55 51	
	<a href="#">PE15A5053F</a>	55 52	
	<a href="#">PE15A5052</a>	55 53	
	<a href="#">PE15A5052F</a>	55 54	
	<a href="#">PE15A5051</a>	54 89	
	<a href="#">PE15A5051F</a>	54 90	
	<a href="#">PE15A4008</a>	54 91	
	<a href="#">PE15A4063F</a>	54 92	
	<a href="#">PE15A4063</a>	54 93	
<b>8.5 GHz to:</b>			
10.5 GHz	<a href="#">PE15A5044</a>	55 55	
11 GHz	<a href="#">PE15A5043</a>	55 56	
	<a href="#">PE15A4006</a>	54 94	
	<a href="#">PE15A4007</a>	54 95	
<b>12 GHz to:</b>			
18 GHz	<a href="#">PE15A4002</a>	48 46	
	<a href="#">PE15A3507</a>	48 55	
	<a href="#">PE15A3296</a>	49 94	
<a href="#">PE15A1004</a>	52 17		
<b>12.4 GHz to:</b>			
26.5 GHz	<a href="#">PE15A3024</a>	48 47	
<b>14.4 GHz to:</b>			
15.4 GHz	<a href="#">PE15A5021</a>	54 96	
<b>17 GHz to:</b>			
24 GHz	<a href="#">PE15A4028</a>	48 48	
27 GHz	<a href="#">PE15A3274</a>	49 95	
<b>17.5 GHz to:</b>			
21.5 GHz	<a href="#">PE15A4020</a>	55 57	
<b>18 GHz to:</b>			
26.5 GHz	<a href="#">PE15A3303</a>	49 96	
	<a href="#">PE15A3260</a>	49 97	
	<a href="#">PE15A4064</a>	54 97	
	<a href="#">PE15A4064F</a>	54 98	
	<a href="#">PE15A4021</a>	54 99	
	<a href="#">PE15A5054</a>	54 1	
	<a href="#">PE15A5054F</a>	54 2	
	<a href="#">PE15A3025</a>	48 49	
	<a href="#">PE15A3268</a>	49 98	
	<a href="#">PE15A3304</a>	49 99	
	<a href="#">PE15A3279</a>	49 1	
	<a href="#">PE15A3305</a>	49 2	
<a href="#">PE15A4065</a>	54 3		
<a href="#">PE15A4065F</a>	54 4		
<b>20 GHz to:</b>			
40 GHz	<a href="#">PE15A3501</a>	50 17	
	<a href="#">PE15A3508</a>	50 18	
	<a href="#">PE15A3509</a>	50 19	
	<a href="#">PE15A3502</a>	50 20	
	<a href="#">PE15A3510</a>	50 21	
<a href="#">PE15A3511</a>	50 22		
<b>26.5 GHz to:</b>			
40 GHz	<a href="#">PE15A4022</a>	48 50	
	<a href="#">PE15A3261</a>	49 3	
	<a href="#">PE15A3266</a>	49 4	
	<a href="#">PE15A3306</a>	49 5	
	<a href="#">PE15A3307</a>	49 6	
	<a href="#">PE15A3300</a>	52 18	
	<a href="#">PE15A4050</a>	54 5	
	<a href="#">PE15A4067</a>	54 6	
	<a href="#">PE15A4067F</a>	54 7	
	<b>29 GHz to:</b>		
	36 GHz	<a href="#">PE15A3275</a>	49 7
	<b>30 GHz to:</b>		
40 GHz	<a href="#">PE15A4069</a>	54 8	
	<a href="#">PE15A4069F</a>	54 9	



Technical Support  
+1 (949) 261-1920



Same-Day Shipping,  
Even Custom Cable Assemblies

## BI-DIRECTIONAL AMPLIFIERS



Amplifiers

Amplifier Type	Frequency Band (GHz.)	Tx Gain (dB)	Gain Var. ±(dB)	P1dB (W)	Rx P1dB (dBm)	Rx NF (dB)	DC Power Tx (V/mA)	ECCN	Model No	1	2-4	5-9	10+	ROW
Bidirectional	30 MHz - 2.7	36	2			2	12/1,400	EAR99	<a href="#">PE15B5003</a>	\$7,128.57	\$6,700.86	\$6,344.43	\$6,059.28	1
Bi-Directional, High Rel	1.35 - 1.39	22	0.5	0.1	20	2.5	28/2,400	EAR99	<a href="#">PE15B5001</a>	\$6,129.41	\$5,884.23	\$5,639.06	\$5,393.88	2
	2.4 - 2.5	20					28/2,400	EAR99	<a href="#">PE15B5000</a>	\$6,491.37	\$6,231.72	\$5,972.06	\$5,712.41	3

## BROADBAND AMPLIFIERS



Amplifier Type	Frequency Band (GHz.)	Gain (dB)	Gain Var. ±(dB)	NF (dB)	P1dB (dBm)	Psat (dBm)	DC Power (V/mA)	ECCN	Model No	1	2-4	5-9	10+	ROW				
Broadband, High Rel	10 MHz - 6	24	0.75	5	29.5		15/740	EAR99	<a href="#">PE15A4032</a>	\$6,013.21	\$5,772.68	\$5,532.15	\$5,291.62	4				
	10 MHz - 15	12	0.3	4.5	28	29	14/360	EAR99	<a href="#">PE15A3036</a>	\$6,643.29	\$6,377.56	\$6,111.83	\$5,846.10	5				
	10 MHz - 20	13	0.75	3	23	25	15/225	EAR99	<a href="#">PE15A4029</a>	\$5,186.23	\$4,978.78	\$4,771.33	\$4,563.88	6				
Broadband	30 MHz - 40	25	2.5	6	20		11/400	EAR99	<a href="#">PE15A3023</a>	\$8,750.97	\$8,400.93	\$8,050.89	\$7,700.85	7				
	100 MHz - 12	18	1	3	25	28	12/300	EAR99	<a href="#">PE15A3007</a>	\$2,321.81	\$2,228.94	\$2,136.07	\$2,043.19	8				
	110 MHz - 6	11	1.25	6.5	27	30	12/300	EAR99	<a href="#">PE15A3004</a>	\$2,441.18	\$2,343.53	\$2,245.89	\$2,148.24	9				
	110 MHz - 10	10	1.5				12/300	EAR99	<a href="#">PE15A3001</a>	\$2,740.56	\$2,630.94	\$2,521.32	\$2,411.69	10				
	Broadband, High Rel	500 MHz - 2	37	2	30.5	24	33	15/750	EAR99	<a href="#">PE15A3021</a>	\$5,706.59	\$5,478.33	\$5,250.06	\$5,021.80	11			
15/750			EAR99	<a href="#">PE15A3021D</a>				Call	Call	Call	Call	12						
12/180			EAR99	<a href="#">PE15A4038</a>				\$1,042.00	\$1,000.32	\$958.64	\$916.96	13						
500 MHz - 2.5		30	0.6	3.5	24	33	33	12/240	EAR99	<a href="#">PE15A3014</a>	\$1,158.42	\$1,112.08	\$1,065.75	\$1,019.41	14			
		46	0.8					12/300	EAR99	<a href="#">PE15A3015</a>	\$1,371.36	\$1,316.51	\$1,261.65	\$1,206.80	15			
		24	0.5					12/240	EAR99	<a href="#">PE15A4039</a>	\$1,299.17	\$1,247.20	\$1,195.24	\$1,143.27	16			
Broadband		500 MHz - 6	32	1	3	25	33	28/600	EAR99	<a href="#">PE15A4037</a>	\$4,445.88	\$4,268.04	\$4,090.21	\$3,912.37	17			
			27	2.5				12/375	EAR99	<a href="#">PE15A3005</a>	\$2,747.12	\$2,637.24	\$2,527.35	\$2,417.47	18			
Broadband, High Rel		500 MHz - 18	33	1.5	4	15	28	12/330	EAR99	<a href="#">PE15A3008</a>	\$3,214.29	\$3,101.79	\$2,989.29	\$2,892.86	19			
			12/220	EAR99				<a href="#">PE15A3263</a>	\$2,465.17	\$2,366.56	\$2,267.96	\$2,169.35	20					
			20	0.5				12/750	EAR99	<a href="#">PE15A3264</a>	\$1,571.57	\$1,508.71	\$1,445.84	\$1,382.98	21			
			30	1.5				12/240	EAR99	<a href="#">PE15A3262</a>	\$2,947.04	\$2,829.16	\$2,711.28	\$2,593.40	22			
	13		0.4	12/180				EAR99	<a href="#">PE15A4040</a>	\$1,558.50	\$1,496.16	\$1,433.82	\$1,371.48	23				
	2 - 6	22	0.6	5.4	33	30	28	12/420	EAR99	<a href="#">PE15A4041</a>	\$2,237.82	\$2,148.31	\$2,058.79	\$1,969.28	24			
		32	1					15/1,700	EAR99	<a href="#">PE15A4003</a>	\$3,816.94	\$3,664.26	\$3,511.58	\$3,358.91	25			
		33	1					12/1,000	EAR99	<a href="#">PE15A4005</a>	\$3,067.47	\$2,944.77	\$2,822.07	\$2,699.37	26			
		36	1.5					15/2,200	EAR99	<a href="#">PE15A4042</a>	\$3,751.20	\$3,601.15	\$3,451.10	\$3,301.06	27			
		44	1					12/4,200	EAR99	<a href="#">PE15A4043</a>	\$4,267.33	\$4,096.64	\$3,925.94	\$3,755.25	28			
2 - 8	33		29.4	16	13	28	8.5/941	EAR99	<a href="#">PE15A3016</a>	\$2,649.52	\$2,543.54	\$2,437.56	\$2,331.58	29				
	12						12/65	EAR99	<a href="#">PE15A4051</a>	\$1,631.05	\$1,565.81	\$1,500.57	\$1,435.32	30				
Broadband, High Rel	2 - 18	33	1.5	3.5	13		12/180	EAR99	<a href="#">PE15A3265</a>	\$2,532.59	\$2,431.29	\$2,329.98	\$2,228.68	31				
Broadband		37			30.5		15/800	EAR99	<a href="#">PE15A3022</a>	\$4,871.87	\$4,677.00	\$4,482.12	\$4,287.25	32				
Broadband, High Rel	2 - 20	15	0.75	3	26	28	12/310	EAR99	<a href="#">PE15A4027</a>	\$5,986.82	\$5,747.35	\$5,507.87	\$5,268.40	33				
Broadband	2 - 24	31					15/400	EAR99	<a href="#">PE15A4030</a>	\$3,921.70	\$3,764.83	\$3,607.96	\$3,451.10	34				
Broadband, High Rel	2 - 35	12	0.4	4	18	18.5	12/260	EAR99	<a href="#">PE15A3009</a>	\$2,122.15	\$2,047.87	\$1,973.60	\$1,909.94	35				
		3.1 - 3.5					30	0.7	4.5	30	12/900	EAR99	<a href="#">PE15A3038</a>	\$7,183.48	\$6,896.14	\$6,608.80	\$6,321.46	36
		16					0.6	5	27	12/400	EAR99	<a href="#">PE15A4044</a>	\$2,084.00	\$2,000.64	\$1,917.28	\$1,833.92	38	
	6 - 12	28	0.8	3.5	30	30	28	12/500	EAR99	<a href="#">PE15A4045</a>	\$2,453.99	\$2,355.83	\$2,257.67	\$2,159.51	37			
		37	1.5					15/2,500	EAR99	<a href="#">PE15A4001</a>	\$3,682.30	\$3,535.01	\$3,387.72	\$3,240.42	40			
		38	1					15/1,300	EAR99	<a href="#">PE15A4004</a>	\$3,488.08	\$3,348.56	\$3,209.03	\$3,069.51	41			
		30	1.5					12/1,300	EAR99	<a href="#">PE15A3018</a>	\$3,102.85	\$2,978.74	\$2,854.62	\$2,730.51	42			
		36						18/1,700	EAR99	<a href="#">PE15A3019</a>	\$3,938.64	\$3,781.09	\$3,623.55	\$3,466.00	43			
		42						15/800	EAR99	<a href="#">PE15A3017</a>	\$3,338.13	\$3,204.60	\$3,071.08	\$2,937.55	44			
	12 - 18	33	2	5.4	27	30	28	12/900	EAR99	<a href="#">PE15A3020</a>	\$3,290.16	\$3,158.55	\$3,026.95	\$2,895.34	45			
		15/2,000	EAR99					<a href="#">PE15A4002</a>	\$3,423.05	\$3,286.13	\$3,149.21	\$3,012.28	46					
		12/500	EAR99					<a href="#">PE15A3024</a>	\$6,888.40	\$6,612.86	\$6,337.33	\$6,061.79	47					
	Broadband, High Rel	17 - 24	22			24		12/250	EAR99	<a href="#">PE15A4028</a>	\$3,774.49	\$3,623.51	\$3,472.53	\$3,321.55	48			
	Broadband	18 - 40	30	2.5	6.5	20	30	12/350	EAR99	<a href="#">PE15A3025</a>	\$6,555.77	\$6,293.54	\$6,031.31	\$5,769.08	49			
		26.5 - 40	30	2	6			12/350	EAR99	<a href="#">PE15A4022</a>	\$5,556.99	\$5,334.71	\$5,112.43	\$4,890.15	50			
High Gain, High Rel	2 - 6	44	1	5	33	30	15/1,050	EAR99	<a href="#">PE15A3503</a>	\$3,072.86	\$2,949.95	\$2,827.03	\$2,704.12	51				
		15/1,750	EAR99				<a href="#">PE15A3504</a>	\$3,868.99	\$3,714.23	\$3,559.47	\$3,404.71	52						
		12/2,500	EAR99				<a href="#">PE15A3506</a>	\$3,966.15	\$3,807.50	\$3,648.86	\$3,490.21	53						
	6 - 12	47	1.5	6	30	30	28	15/1,350	EAR99	<a href="#">PE15A3505</a>	\$3,340.84	\$3,207.21	\$3,073.57	\$2,939.94	54			
		48	1					15/2,000	EAR99	<a href="#">PE15A3507</a>	\$3,755.07	\$3,604.87	\$3,454.66	\$3,304.46	55			

See Our Website For Current Pricing & Real-Time Stock Availability!

# BROADBAND AMPLIFIERS



Amplifier Type	Frequency Band (GHz.)	Gain (dB)	Gain Var. ±(dB)	NF (dB)	P1dB (dBm)	Psat (dBm)	DC Power (V/mA)	ECCN	Model No	1 Pc. Price	See Web for Volume Pricing	ROW
Low Noise	0.01 MHz - 3	16	1.5	4	12		15/47	EAR99	<a href="#">PE15A3308</a>	\$750.24	See Web for Volume Pricing	56
	0.1 MHz - 10	33	6.5	5	13		12/110	EAR99	<a href="#">PE15A3311</a>	\$909.42		57
	0.3 MHz - 6.5	39	4.5		17		12/120	EAR99	<a href="#">PE15A3310</a>	\$909.42		58
	1 MHz - 3	21	1.5	4	22		15/110	EAR99	<a href="#">PE15A3309</a>	\$880.54		59
Low Noise, High Rel	10 MHz - 6	34	1		14.5	24	12/130	EAR99	<a href="#">PE15A3269</a>	\$562.97		60
	10 MHz - 20	15	0.5	3	22		12/195	EAR99	<a href="#">PE15A3272</a>	\$5,388.49		61
30 MHz - 20	2.5		20			15/180	EAR99	<a href="#">PE15A3254</a>	\$3,294.88	62		
Low Noise	100 MHz - 18	14	1.5	16	18		12/80	EAR99	<a href="#">PE15A3255</a>	\$1,399.27		63
		28	2.5				12/160	EAR99	<a href="#">PE15A3256</a>	\$2,719.81		64
Low Noise, High Rel	100 MHz - 26.5	15		5	15		15/200	EAR99	<a href="#">PE15A3267</a>	\$5,179.43		65
Low Noise	100 MHz - 40	25	2	3			15/	EAR99	<a href="#">PE15A3280</a>	Call		66
							15/	EAR99	<a href="#">PE15A3281</a>	Call		67
							15/	EAR99	<a href="#">PE15A3282</a>	Call		68
							15/	EAR99	<a href="#">PE15A3283</a>	Call		69
							15/	EAR99	<a href="#">PE15A3284</a>	Call		70
							15/	EAR99	<a href="#">PE15A3285</a>	Call		71
							15/	EAR99	<a href="#">PE15A3286</a>	Call		72
							15/	EAR99	<a href="#">PE15A3287</a>	Call		73
							15/	EAR99	<a href="#">PE15A3288</a>	Call		74
							15/	EAR99	<a href="#">PE15A3289</a>	Call		75
Low Noise, High Rel	500 MHz - 20	14	1.75		14		15/75	EAR99	<a href="#">PE15A3253</a>	\$2,798.10		76
Low Noise	1 - 20	17	1.25			17	15/	EAR99	<a href="#">PE15A3278</a>	Call		77
Low Noise, High Rel	1.8 - 4.2	26		1.2	15.5	17.5	12/105	EAR99	<a href="#">PE15A3276</a>	\$6,416.96		78
Low Noise	2 - 6	35	1	3		18	15/	EAR99	<a href="#">PE15A3277</a>	Call		79
Low Noise, High Rel	2 - 8	14		2.5	13		12/120	EAR99	<a href="#">PE15A3290</a>	\$1,736.68		80
		30					12/150	EAR99	<a href="#">PE15A3291</a>	\$2,165.28		81
Low Noise	2 - 18	22	2.5	3.2	14		12/100	EAR99	<a href="#">PE15A3301</a>	\$5,446.20		82
		26	2	3			12/150	EAR99	<a href="#">PE15A3257</a>	\$1,801.23		83
		33	1				12/180	EAR99	<a href="#">PE15A3258</a>	\$2,231.46		84
Low Noise, High Rel	2 - 20	13	0.5	2	16	21	12/	EAR99	<a href="#">PE15A3271</a>	\$3,774.49		85
		15			13	15.5	12/78	EAR99	<a href="#">PE15A3270</a>	\$4,451.91		86
		17			7		12/100	EAR99	<a href="#">PE15A3292</a>	\$2,003.79		87
	30					12/200	EAR99	<a href="#">PE15A3293</a>	\$2,309.62	88		
	14			3	13		12/100	EAR99	<a href="#">PE15A3295</a>	\$1,945.08		89
	30			2.5	10		12/200	EAR99	<a href="#">PE15A3294</a>	\$2,523.29		90
Low Noise	6 - 18	32	1.5	2.3	14		12/150	EAR99	<a href="#">PE15A3302</a>	\$5,314.20		91
		38	2		22		12/280	EAR99	<a href="#">PE15A3259</a>	\$1,605.83		92
Low Noise, High Rel	7 - 17	22			14		12/93	EAR99	<a href="#">PE15A3273</a>	\$3,774.49		93
	12 - 18	18		3.5	13		12/100	EAR99	<a href="#">PE15A3296</a>	\$1,875.60		94
	17 - 27	19		2.75	13.5		12/96	EAR99	<a href="#">PE15A3274</a>	\$5,762.10		95
Low Noise	18 - 26.5	32	2.5	2.3	11		12/250	EAR99	<a href="#">PE15A3303</a>	\$5,307.25		96
		40			2.5	13		12/150	EAR99	<a href="#">PE15A3260</a>		\$2,055.76
Low Noise, High Rel	18 - 40	18	2	5.5	10		15/250	3A001.B.4.C	<a href="#">PE15A3268</a>	\$7,581.60		98
35				12		12/200	EAR99	<a href="#">PE15A3304</a>	\$9,041.10	99		
44		4		11	12		20/	EAR99	<a href="#">PE15A3279</a>	Call		1
Low Noise	26.5 - 40	22	1	3.5	13.5		12/250	EAR99	<a href="#">PE15A3305</a>	\$9,982.36		2
		30	2	2	11		12/125	EAR99	<a href="#">PE15A3261</a>	\$1,989.64	3	
		30	2	2	11		12/150	EAR99	<a href="#">PE15A3266</a>	\$5,800.82	4	
		35	2.5	2.4	10.5		12/150	EAR99	<a href="#">PE15A3306</a>	\$8,165.82	5	
		52	3.5	3.3	12		12/375	EAR99	<a href="#">PE15A3307</a>	\$9,881.63	6	
Low Noise, High Rel	29 - 36	20		2.9	11		3/80	EAR99	<a href="#">PE15A3275</a>	\$3,774.49	7	

Amplifiers

See Our Website For Current Pricing & Real-Time Stock Availability!

## USB CONTROLLED BROADBAND AMPS.



Amplifier Type	Frequency Band (GHz.)	Gain (dB)	NF (dB)	P1dB (dBm)	Control	ECCN	Model No	1	2-4	5-9	10+	ROW
USB	50 MHz - 18	12	4.5	10	USB	EAR99	<a href="#">PE15A3900</a>	\$3,218.23	\$3,089.50	\$2,960.77	\$2,832.04	8
	50 MHz - 40		5				<a href="#">PE15A3901</a>	\$5,312.91	\$5,100.39	\$4,887.88	\$4,675.36	9

Technical Support  
+1 (949) 261-1920

Same-Day Shipping,  
Even Custom  
Cable Assemblies

## BENCH-TOP AMPLIFIERS



Amplifiers

Amplifier Type	Frequency Band (GHz.)	Gain (dB)	Gain Var. ±(dB)	NF (dB)	P1dB (dBm)	DC Power (Optional DC In) (V)	AC Power (V/Cycle)	ECCN	Model No	1	2-4	5-9	10+	ROW
Broadband, High Rel	10 MHz - 15	12	0.3	4	28	16/360		EAR99	<a href="#">PE15A3037</a>	\$6,565.04	\$6,302.44	\$6,039.84	\$5,777.24	10
High Gain, High Rel	1 - 20	60	3	5	10	12/	115/60	EAR99	<a href="#">PE15A3500</a>	\$11,353.64	\$10,899.49	\$10,445.35	\$9,991.20	11
							100/	EAR99	<a href="#">PE15A3512</a>	\$11,444.29	\$10,986.52	\$10,528.75	\$10,070.98	12
							220/	EAR99	<a href="#">PE15A3513</a>	\$12,159.55	\$11,673.17	\$11,186.79	\$10,700.40	13
	100/	EAR99	<a href="#">PE15A3514</a>				\$15,612.29	\$14,987.80	\$14,363.31	\$13,738.82	14			
	220/	EAR99	<a href="#">PE15A3515</a>				\$15,612.29	\$14,987.80	\$14,363.31	\$13,738.82	15			
	120/60	EAR99	<a href="#">PE15A3595</a>				\$16,004.27	\$15,444.12	\$14,883.97	\$14,403.84	16			
	20 - 40	30	2	10	115/60	EAR99	<a href="#">PE15A3501</a>	\$11,894.96	\$11,419.16	\$10,943.36	\$10,467.56	17		
					100/60	EAR99	<a href="#">PE15A3508</a>	\$11,962.16	\$11,483.67	\$11,005.19	\$10,526.70	18		
					220/	EAR99	<a href="#">PE15A3509</a>	\$11,962.16	\$11,483.67	\$11,005.19	\$10,526.70	19		
		115/60	EAR99		<a href="#">PE15A3502</a>	\$14,601.55	\$14,017.49	\$13,433.43	\$12,849.36	20				
		100/	EAR99		<a href="#">PE15A3510</a>	\$14,570.29	\$13,987.48	\$13,404.67	\$12,821.86	21				
		220/	EAR99		<a href="#">PE15A3511</a>	\$14,570.29	\$13,987.48	\$13,404.67	\$12,821.86	22				

## GAIN BLOCK AMPLIFIERS



Amplifier Type	Frequency Band (GHz.)	Gain (dB)	Gain Var. ±(dB)	NF (dB)	P1dB (dBm)	IP3 (dBm)	DC Power (V/mA)	ECCN	Model No	1 Pc. Price	See Web for Volume Pricing	ROW
Gain Block	10 MHz - 3	12	10	5.5	10		15/40	EAR99	<a href="#">PE1514</a>	\$468.50	See Web for Volume Pricing	23
		15	2	3	11	12	18/40	EAR99	<a href="#">PE1528</a>	\$153.93		24
	20	14	2.7	13		15/50	EAR99	<a href="#">PE1513</a>	\$464.79	25		
	10 MHz - 6	15	0.35	4.5		26	12/50	EAR99	<a href="#">PE15A8001</a>	\$717.47		26
	50 MHz - 1	22	0.75	3.5	12		12/150	EAR99	<a href="#">PE1517</a>	\$516.15		27
	50 MHz - 2						12/150	EAR99	<a href="#">PE1518</a>	\$634.95		28
	50 MHz - 4	26	1	5	22	35	12/120	EAR99	<a href="#">PE15A8000</a>	\$745.45		29
	100 MHz - 3	18	18	6	16		15/120	EAR99	<a href="#">PE1516</a>	\$539.49		30
200 MHz - 2.5	22	1.25	6	15		15/120	EAR99	<a href="#">PE1525</a>	\$537.84	31		
Gain Block, High Rel	500 MHz - 2	17	0.4	1.8		25	12/70	EAR99	<a href="#">PE15A8004</a>	\$937.80	32	
		50	1.8				12/180	EAR99	<a href="#">PE15A8005</a>	\$1,226.99	33	
Gain Block	1 - 4	26		2.5	15		12/120	EAR99	<a href="#">PE1519</a>	\$1,000.04	34	
	2 - 4	25	0.5	3	15		12/120	EAR99	<a href="#">PE1520</a>	\$1,039.00	35	
	2 - 6	26		3	13		12/120	EAR99	<a href="#">PE1521</a>	\$877.23	36	
	2 - 18	23	1	3.5	13		12/150	EAR99	<a href="#">PE1524</a>	\$1,256.64	37	
Gain Block, High Rel	4 - 8	26	0.5	3	15		12/100	EAR99	<a href="#">PE1522</a>	\$948.77	38	
		6 - 12	12	0.4	2.3	10	20	12/80	EAR99	<a href="#">PE15A8006</a>	\$1,371.36	39
Gain Block	6 - 18	17	0.6	4.5	20		12/160	EAR99	<a href="#">PE15A8007</a>	\$1,912.68	40	
		22	1	13			12/150	EAR99	<a href="#">PE1523</a>	\$1,357.12	41	

## DC COUPLED AMPLIFIERS



Amplifier Type	Frequency Band (GHz.)	Gain (dB)	Gain Var. ±(dB)	NF (dB)	P1dB (dBm)	IP3 (dBm)	DC Power (V/mA)	ECCN	Model No	1-4	5-9	10-24	25+	ROW
DC Coupled	DC - 17 MHz	30			14	25	/45	EAR99	<a href="#">PE15A86002</a>	\$609.88	\$579.39	\$548.89	\$524.50	42
	DC - 1.5	14			11	25	/45	EAR99	<a href="#">PE15A86001</a>	\$880.54	\$836.51	\$792.49	\$757.26	43
	DC - 2	8		16			12/45	EAR99	<a href="#">PE15A86000</a>	\$847.49	\$805.12	\$762.74	\$728.84	44

## LIMITING AMPLIFIERS



Amplifier Type	Frequency Band (GHz.)	Gain (dB)	Gain Var. ±(dB)	NF (dB)	Input Power (dBm)	Psat (dBm)	DC Power (V/mA)	ECCN	Model No	1	2-4	5-9	10+	ROW
Limitings, High Rel	1 - 2	60	3	3	-40 to 10	19	13/250	EAR99	<a href="#">PE15A6002</a>	\$2,315.90	\$2,223.26	\$2,130.63	\$2,037.99	45

See Our Website For Current Pricing & Real-Time Stock Availability!

## LIMITING AMPLIFIERS



Amplifier Type	Frequency Band (GHz.)	Gain (dB)	Gain Var. ±(dB)	NF (dB)	Input Power (dBm)	Psat (dBm)	DC Power (V/mA)	ECCN	Model No	1	2-4	5-9	10+	ROW
Limitings, High Rel	2 - 4	40		3	-20 to 10	19	15/200	EAR99	<a href="#">PE15A6015</a>	\$2,396.60	\$2,300.74	\$2,204.87	\$2,109.01	46
	2 - 6	80	3	4	-61 to 10	15	13/550	EAR99	<a href="#">PE15A6007</a>	\$2,968.58	\$2,849.84	\$2,731.09	\$2,612.35	47
	2 - 8	40	2	5	-20 to 20	19	13/300	EAR99	<a href="#">PE15A6008</a>	\$2,282.81	\$2,191.50	\$2,100.19	\$2,008.87	48
	6 - 18			4			13/300	EAR99	<a href="#">PE15A6012</a>	\$2,778.78	\$2,667.63	\$2,556.48	\$2,445.33	49

## LOG AMPLIFIERS



Amplifier Type	Frequency Band (GHz.)	Typ Recovery Time (ns)	Min TSS (dBm)	Log Linearity ± (dB)	Log Range (dBm)	Rise Time (ns)	Log Slope (mV/dB)	ECCN	Model No	1	2-4	5-9	10+	ROW
Log, High Rel	500 MHz - 4	40	-73	2.5	-70 to 0	5	25	EAR99	<a href="#">PE15A2000</a>	\$14,466.76	\$13,888.09	\$13,309.42	\$12,730.75	50
	500 MHz - 18	150	-65	1.75	-65 to 5	20	20	EAR99	<a href="#">PE15A2003</a>	\$16,799.48	\$16,127.50	\$15,455.52	\$14,783.54	51
	2 - 6	60	-73			15	40	EAR99	<a href="#">PE15A2001</a>	\$10,530.95	\$10,109.71	\$9,688.47	\$9,267.24	52
	6 - 18	70	-72	2.5	-70 to 0	50	25	EAR99	<a href="#">PE15A2002</a>	\$14,466.76	\$13,888.09	\$13,309.42	\$12,730.75	53
		150	-40	1	-40 to 0	20	50	EAR99	<a href="#">PE15A2004</a>	\$6,752.97	\$6,482.85	\$6,212.73	\$5,942.61	54

## LOW NOISE AMPLIFIERS

### Standard



Amplifier Type	Frequency Band (GHz.)	Gain (dB)	Gain Var. ±(dB)	NF (dB)	P1dB (dBm)	IP3 (dBm)	DC Power (V/mA)	ECCN	Model No	1 Pc. Price	See Web for Volume Pricing	ROW		
Low Noise	0.009 MHz - 3	32	1.25	2.5	16	29	15/110	EAR99	<a href="#">PE15A1007</a>	\$437.21	See Web for Volume Pricing	55		
		45	0.5		11	23	16/75	EAR99	<a href="#">PE15A1046</a>	\$688.24		56		
	0.01 MHz - 1.4	42	1	3	19	32	16/120	EAR99	<a href="#">PE15A1055</a>	\$800.39		57		
		28	2	3.2	13	23	18/45	EAR99	<a href="#">PE15A1059</a>	\$579.98		58		
	0.03 MHz - 600 MHz	50	1.2	2.2	14	24	18/85	EAR99	<a href="#">PE15A1047</a>	\$869.98		59		
	1 MHz - 500 MHz	33.5	1.5	2	13		30/40	EAR99	<a href="#">PE15A1045</a>	\$579.98		60		
	10 MHz - 250 MHz	17	0.5	1.4	22	39	5.25/160	EAR99	<a href="#">PE15A1043</a>	\$800.39		61		
	10 MHz - 550 MHz	29.7	0.3	1.7	19	34	15/105	EAR99	<a href="#">PE15A1044</a>	\$726.93		62		
	10 MHz - 600 MHz	40.5	0.8	0.9		15/140	EAR99	<a href="#">PE15A1063</a>	\$1,163.84	63				
	10 MHz - 800 MHz	42	0.7	2	17	30	15/100	EAR99	<a href="#">PE15A1048</a>	\$699.64		64		
		60	1.5	2.1		27	15/160	EAR99	<a href="#">PE15A1065</a>	\$1,299.17		65		
	High Gain	10 MHz - 1	30	0.7	1	12	23	15/110	EAR99	<a href="#">PE15A1011</a>		\$435.43	66	
			32	2	12			23	15/40	EAR99		<a href="#">PE15A1049</a>	\$524.72	67
			40	1	0.8			17	31.5	15/110		EAR99	<a href="#">PE15A1012</a>	\$460.21
50			1.25	1	18			28	15/140	EAR99	<a href="#">PE15A1013</a>	\$545.11	69	
Low Noise	10 MHz - 1.3	51	0.8	2.2	13	22	15/88	EAR99	<a href="#">PE15A1052</a>	\$800.39	70			
		35	0.5	1.5	20	34	15/165	EAR99	<a href="#">PE15A1054</a>	\$947.31	71			
	10 MHz - 3	34	0.75	1.4	11	25	15/95	EAR99	<a href="#">PE15A1009</a>	\$706.31	72			
	20 MHz - 1	30	0.5	1.3	18	32	18/140	EAR99	<a href="#">PE15A1051</a>	\$770.35	73			
		30.5	0.8		19	34	15/140	EAR99	<a href="#">PE15A1064</a>	\$1,163.84	74			
	20 MHz - 1.5	20	1.2	1	17	35	18/70	EAR99	<a href="#">PE15A1057</a>	\$688.24	75			
	20 MHz - 3	25	0.75	1.6	13.5	25	15/75	EAR99	<a href="#">PE15A1008</a>	\$565.00	76			
	20 MHz - 4		0.7	2	18	34	5.5/160	EAR99	<a href="#">PE15A1061</a>	\$982.10	77			
40 MHz - 3	16	1.6	1.3	7	22	3.3/18	EAR99	<a href="#">PE15A1060</a>	\$699.64	78				
Linear Low Noise	50 MHz - 1	15	0.7	1.5	23	37	12/85	EAR99	<a href="#">PE15A9001</a>	\$345.62	79			
		18	0.5	1	16	32	18/70	EAR99	<a href="#">PE15A1050</a>	\$662.41	80			
Low Noise	50 MHz - 1	19			18	36	12/90	EAR99	<a href="#">PE15A1014</a>	\$289.88	81			
		47	1	2.2	13	23	15/88	EAR99	<a href="#">PE15A1053</a>	\$800.39	82			
	50 MHz - 2	27	0.75	1.8	22	37	13.5/160	EAR99	<a href="#">PE15A1042</a>	\$663.79	83			
	100 MHz - 2	61.5	1	2.5	19	33	15/170	EAR99	<a href="#">PE15A1066</a>	\$1,419.02	84			
	500 MHz - 3	14.5	0.4	2	20	35	12/90	EAR99	<a href="#">PE15A1017</a>	\$339.09	85			
		29	1	2.6		12/190	EAR99	<a href="#">PE15A1018</a>	\$429.12	86				
	500 MHz - 4	24	2.5	0.7	17	34	15/65	EAR99	<a href="#">PE15A1068</a>	\$800.39	87			
	700 MHz - 2.7	23	2.5		18	35	15/65	EAR99	<a href="#">PE15A1067</a>	\$800.39	88			
Low Noise, High Rel	1 - 2	35	1	1.5	10		13/200	EAR99	<a href="#">PE15A1000</a>	\$1,274.41	89			

Amplifiers

See Our Website For Current Pricing & Real-Time Stock Availability!

## Standard



Amplifiers

Amplifier Type	Frequency Band (GHz.)	Gain (dB)	Gain Var. ±(dB)	NF (dB)	P1dB (dBm)	IP3 (dBm)	DC Power (V/mA)	ECCN	Model No	1 Pc. Price	See Web for Volume Pricing	ROW
High Gain	1 - 2	40	1	0.8	11	25	12/120	EAR99	<a href="#">PE15A1019</a>	\$973.08	See Web for Volume Pricing	90
Low Noise	1 - 4	20	1.2		20	41	15/120	EAR99	<a href="#">PE15A1070</a>	\$800.39		91
Low Noise, High Rel	1 - 12	16	0.75	1.5	17	10	6/60	EAR99	<a href="#">PE15A1031</a>	\$5,345.66		92
		25			13.2/150		EAR99	<a href="#">PE15A1023</a>	\$614.05	93		
		35			13.2/180		EAR99	<a href="#">PE15A1024</a>	\$688.46	94		
High Gain, High Rel	1.2 - 1.4	40	0.5	0.8	12	15	13.2/200	EAR99	<a href="#">PE15A1005</a>	\$1,146.33		95
Low Noise		15/100			EAR99		<a href="#">PE15A1028</a>	\$649.58	96			
Integrated Band Pass Filter Low Noise	1.215 - 1.4	25	0.75	0.5	16	16	12/130	EAR99	<a href="#">PE15A1039</a>	\$973.83		97
		35					12/130	EAR99	<a href="#">PE15A1040</a>	\$902.19		98
Low Phase Noise, High Rel	1.5 - 5	14		4.5	17	27	9/170	EAR99	<a href="#">PE15A1034</a>	\$5,923.34		99
Low Noise, High Rel	2 - 4	38	1	2	13		13/200	EAR99	<a href="#">PE15A1001</a>	\$1,543.07		1
High Gain	2 - 6	40		0.9	14	25	15/90	EAR99	<a href="#">PE15A1010</a>	\$1,039.46		2
Low Phase Noise, High Rel	2 - 18	12.5		6.5	13		5/80	EAR99	<a href="#">PE15A1030</a>	\$9,855.78		3
	3 - 8	11		6	14	25	7/250	EAR99	<a href="#">PE15A1035</a>	\$5,923.34		4
High Gain, High Rel	3.1 - 3.5	40	0.3	1.1	15		17/150	EAR99	<a href="#">PE15A1006</a>	\$1,776.25		5
Low Noise, High Rel	4 - 8	38	1	2	13		13/250	EAR99	<a href="#">PE15A1002</a>	\$1,667.45		6
	5 - 9	22.5		1.75	14.8	25	12/105	EAR99	<a href="#">PE15A9002</a>	\$6,942.42		7
Low Phase Noise, High Rel	6 - 12	11	1	4.5	20	34	7/200	EAR99	<a href="#">PE15A1032</a>	\$6,154.35		8
		25		0.7	2.1	11	25	5.5/65	EAR99	<a href="#">PE15A1072</a>	\$1,562.11	9
Low Noise	6 - 18	26	2.5	1.9					5.5/65	EAR99	<a href="#">PE15A1071</a>	\$1,635.55
Low Phase Noise, High Rel	7 - 11	9		6	22	33	7/300	EAR99	<a href="#">PE15A1033</a>	\$6,910.58	11	
Low Noise, High Rel	8 - 12	18	1	2.2	13		13/150	EAR99	<a href="#">PE15A1027</a>	\$1,623.96	12	
		28					13/200	EAR99	<a href="#">PE15A1026</a>	\$1,803.68	13	
		38					13/250	EAR99	<a href="#">PE15A1003M</a>	\$2,003.59	14	
		48					13/250	EAR99	<a href="#">PE15A1003</a>	\$1,928.82	15	
		38					13/300	EAR99	<a href="#">PE15A1025</a>	\$2,236.74	16	
Low Noise	12 - 18	38		3	13		13/300	EAR99	<a href="#">PE15A1004</a>	\$2,194.81	17	
Low Noise	26.5 - 40	43	2	2	12	20	15/110	EAR99	<a href="#">PE15A3300</a>	\$3,220.47	18	

## Input Protected



See Our Website For Current Pricing & Real-Time Stock Availability!

Amplifier Type	Frequency Band (GHz.)	Gain (dB)	Gain Var. ±(dB)	NF (dB)	P1dB (dBm)	IP3 (dBm)	DC Power (V/mA)	ECCN	Model No	1-4	5-9	10-24	25+	ROW
Input Protected Low Noise	10 MHz - 1	30	0.7	1	17	32	15/120	EAR99	<a href="#">PE15A63000</a>	\$680.00	\$646.00	\$612.00	\$584.80	19
		40	1			31.5	15/110	EAR99	<a href="#">PE15A63001</a>	\$680.00	\$646.00	\$612.00	\$584.80	20
	30 MHz - 1.5	25	0.5	1.6	22	39	15/150	EAR99	<a href="#">PE15A63002</a>	\$635.51	\$603.73	\$571.96	\$546.54	21
		29			23		15/160	EAR99	<a href="#">PE15A63003</a>	\$635.51	\$603.73	\$571.96	\$546.54	22
	900 MHz - 1.2	30	1	1.2	10		12/100	EAR99	<a href="#">PE15A63004</a>	\$595.45	\$565.68	\$535.91	\$512.09	23
		40					12/100	EAR99	<a href="#">PE15A63005</a>	\$595.45	\$565.68	\$535.91	\$512.09	24
	1 - 1.4	30					12/110	EAR99	<a href="#">PE15A63006</a>	\$595.45	\$565.68	\$535.91	\$512.09	25
Input Protected GaN Low Noise	1 - 7	42	4	1.6	21	30		EAR99	<a href="#">PE15A1075</a>	Call	Call	Call	Call	26
	1 - 23	29	1.5	4	23	32		EAR99	<a href="#">PE15A1074</a>	Call	Call	Call	Call	27
Input Protected Low Noise	2 - 2.6	30	0.35	0.85	12		15/110	EAR99	<a href="#">PE15A63007</a>	\$929.56	\$883.08	\$836.60	\$799.42	28
			1	1.2	10		12/120	EAR99	<a href="#">PE15A63008</a>	\$920.79	\$874.75	\$828.71	\$791.88	29
	2.6 - 3.1	40	1	1.2	10		12/120	EAR99	<a href="#">PE15A63009</a>	\$844.02	\$801.82	\$759.62	\$725.86	30
		28					0.5	0.8	8	20	15/45	EAR99	<a href="#">PE15A63010</a>	\$844.02
	3.1 - 3.5	35	1	0.85	13		12/100	EAR99	<a href="#">PE15A63011</a>	\$876.94	\$833.09	\$789.25	\$754.17	32
Input Protected GaN Low Noise	5 - 13	46	1.5	1.8	21	30		EAR99	<a href="#">PE15A1073</a>	Call	Call	Call	Call	33



# POWER AMPLIFIERS (<4W)



Amplifier Type	Frequency Band (GHz.)	Gain (dB)	Gain Var. ±(dB)	NF (dB)	P1dB (dBm)	Psat (dBm)	DC Power (V/mA)	ECCN	Model No	1 Pc. Price	See Web for Volume Pricing	ROW
High Power, Class AB	1 MHz - 1	36	1.5		33	36	28/1,200	EAR99	<a href="#">PE15A5030</a>	\$2,953.73		34
High Power, Class AB, Power with Fan							28/1,700	EAR99	<a href="#">PE15A5030F</a>	\$3,710.72		35
High Power, Class AB	1.5 MHz - 30 MHz 1.5 MHz - 100 MHz 20 MHz - 520 MHz	47	2		47	50	28/5,000	EAR99	<a href="#">PE15A5055</a>	\$5,120.00		36
							28/5,000	EAR99	<a href="#">PE15A5056</a>	\$6,600.00		37
							28/9,000	EAR99	<a href="#">PE15A5065</a>	\$6,106.67		38
Power	20 MHz - 1	40	0.5	6	36		24/630	EAR99	<a href="#">PE15A4072</a>	\$2,071.44		39
High Power, Class AB		49	2			49	28/11,000	EAR99	<a href="#">PE15A5057</a>	\$7,586.67		40
Power	20 MHz - 3 30 MHz - 3 50 MHz - 1 60 MHz - 6	27	0.75	5	30	28	12/220	EAR99	<a href="#">PE15A4017</a>	\$779.59		41
							12/270	EAR99	<a href="#">PE15A4018</a>	\$899.55		42
							12/450	EAR99	<a href="#">PE15A4009</a>	\$1,199.24		43
							15/530	EAR99	<a href="#">PE15A4019</a>	\$2,600.82		44
High Rel	100 MHz - 18	25	3	8	29		15/1,000	EAR99	<a href="#">PE15A4052</a>	\$10,238.16		45
High Rel, Power with Fan							15/2,160	EAR99	<a href="#">PE15A4052F</a>	Call		46
Power, Class AB	200 MHz - 2.6	46	4		33	10	28/1,400	EAR99	<a href="#">PE15A5084</a>	\$4,791.75		47
High Power, Class AB	500 MHz - 1	50	2			50	28/10,000	EAR99	<a href="#">PE15A5058</a>	\$6,600.00		48
High Rel	500 MHz - 4	30	3	6	30		12/1,500	EAR99	<a href="#">PE15A4053</a>	\$3,890.28		49
High Rel, Power with Fan							12/2,660	EAR99	<a href="#">PE15A4053F</a>	\$4,840.32		50
High Power, Class AB	800 MHz - 1	53	2			53	28/25,000	EAR99	<a href="#">PE15A5061</a>	\$6,600.00		51
Power, Class AB	800 MHz - 2	55	2.5		31	40	28/3,000	EAR99	<a href="#">PE15A5077</a>	\$4,753.45		52
Power, Class AB, Power with Fan							13/1,000	EAR99	<a href="#">PE15A5034F</a>	\$2,488.33		53
Power, Class AB	800 MHz - 4.2	31	2		30.8	31.8	13/800	EAR99	<a href="#">PE15A5034</a>	\$1,870.01	See Web for Volume Pricing	54
Power	820 MHz - 960 MHz	15	0.5	2	30		12/500	EAR99	<a href="#">PE15A4026</a>	\$523.84		55
							12/600	EAR99	<a href="#">PE15A4025</a>	\$1,321.61		56
High Power	1 - 2	35	0.75	1.5	33		12/800	EAR99	<a href="#">PE15A4016</a>	\$1,543.77		57
Power, Class AB	1 - 2.5	14	3		33	20	28/2,200	EAR99	<a href="#">PE15A5085</a>	\$4,604.15		58
							28/650	EAR99	<a href="#">PE15A5083</a>	\$4,032.41		59
Power	1.2 - 1.4	46	0.5	2		28	12/400	EAR99	<a href="#">PE15A4010</a>	\$1,655.81		60
Power, Class AB	2 - 2.6	54	2.5		31	30	28/2,400	EAR99	<a href="#">PE15A5074</a>	\$4,727.48		61
High Power	2 - 4.4	32	0.5	10	36	37		EAR99	<a href="#">PE15A4011</a>	\$2,399.52		62
High Rel	2 - 8	38	2.5	5.5	30		12/1,200	EAR99	<a href="#">PE15A4054</a>	\$5,574.70		63
High Rel, Power with Fan							12/2,360	EAR99	<a href="#">PE15A4054F</a>	\$6,726.67		64
High Rel	2 - 12	35	4		33		15/4,500	EAR99	<a href="#">PE15A4055</a>	\$12,935.70		65
High Rel, Power with Fan							15/5,660	EAR99	<a href="#">PE15A4055F</a>	\$14,868.75		66
High Rel	2 - 18	30	2.5		30		12/2,500	EAR99	<a href="#">PE15A4056</a>	\$11,722.50		67
High Rel, Power with Fan							12/3,660	EAR99	<a href="#">PE15A4056F</a>	\$12,626.67		68
Power	2 - 20	30	4		33		12/5,000	EAR99	<a href="#">PE15A4057</a>	\$13,537.08		69
Power with Fan							12/6,160	EAR99	<a href="#">PE15A4057F</a>	\$14,588.24		70
High Rel	2 - 20	30	5.5		31		12/4,500	EAR99	<a href="#">PE15A4058</a>	\$13,073.64		71
High Rel, Power with Fan							12/5,660	EAR99	<a href="#">PE15A4058F</a>	\$13,923.33		72
High Power	2.2 - 2.7	50	1.5			49	28/11,000	EAR99	<a href="#">PE15A5022</a>	\$13,791.18		73
	3.1 - 3.5	45	2	4		40	15/5,000	EAR99	<a href="#">PE15A5002</a>	\$3,025.04		74
	3.5 - 7	26	2	11	36	37	1/1,600	EAR99	<a href="#">PE15A4012</a>	\$2,971.54		75
Power, Class AB, Power with Fan	4.4 - 4.9	48	5		33	20	28/3,600	5A991.G	<a href="#">PE15A5079</a>	\$7,853.42		76
							28/3,600	5A991.G	<a href="#">PE15A5080</a>	\$8,853.42	77	
High Rel	6 - 12	47	2.5	6.5	30.5		12/1,500	EAR99	<a href="#">PE15A4060</a>	\$4,869.61		78

Amplifiers

See Our Website For Current Pricing & Real-Time Stock Availability!

## POWER AMPLIFIERS (<4W)



Amplifiers

Amplifier Type	Frequency Band (GHz.)	Gain (dB)	Gain Var. ±(dB)	NF (dB)	P1dB (dBm)	Psat (dBm)	DC Power (V/mA)	ECCN	Model No	1	2-4	5-9	10+	ROW
High Rel, Power with Fan	6 - 12	47	2.5	6.5	30.5		12/2,660	EAR99	<a href="#">PE15A4060F</a>	\$5,854.84	\$5,620.65	\$5,386.45	\$5,152.26	79
		30		7	27		12/1,380	EAR99	<a href="#">PE15A4061F</a>	\$6,421.88	\$6,165.00	\$5,908.13	\$5,651.25	80
High Rel	6 - 18	35	3.5	10	30		12/800	EAR99	<a href="#">PE15A4061</a>	\$5,597.24	\$5,373.35	\$5,149.46	\$4,925.57	81
							12/2,500	EAR99	<a href="#">PE15A5048</a>	\$10,821.91	\$10,389.03	\$9,956.16	\$9,523.28	82
High Rel, Power with Fan	6 - 18	38	3.5	10	30		12/3,660	EAR99	<a href="#">PE15A5048F</a>	\$11,905.88	\$11,429.64	\$10,953.41	\$10,477.17	83
High Rel							12/1,800	EAR99	<a href="#">PE15A4062</a>	\$9,767.01	\$9,376.33	\$8,985.65	\$8,594.97	84
High Rel, Power with Fan	7.5 - 11	25	2		33	37	12/2,960	EAR99	<a href="#">PE15A4062F</a>	\$10,750.00	\$10,320.00	\$9,890.00	\$9,460.00	85
High Power							31	34	EAR99	<a href="#">PE15A4013</a>	\$2,401.25	\$2,305.20	\$2,209.15	\$2,113.10
High Power	8 - 11	28	3		32	36	12/3,660	EAR99	<a href="#">PE15A4014</a>	\$2,053.40	\$1,971.26	\$1,889.13	\$1,806.99	87
High Power							12/2,500	EAR99	<a href="#">PE15A4015</a>	\$2,052.41	\$1,970.31	\$1,888.22	\$1,806.12	88
High Rel	8 - 12	30	2		33		12/2,500	EAR99	<a href="#">PE15A5051</a>	\$6,698.57	\$6,430.63	\$6,162.68	\$5,894.74	89
High Rel, Power with Fan							12/3,660	EAR99	<a href="#">PE15A5051F</a>	\$7,832.35	\$7,519.06	\$7,205.76	\$6,892.47	90
Power	8 - 12.4	41	1	3.5	30	31	12/1,200	EAR99	<a href="#">PE15A4008</a>	\$3,144.35	\$3,018.58	\$2,892.80	\$2,767.03	91
High Rel, Power with Fan							12/1,380	EAR99	<a href="#">PE15A4063F</a>	\$4,843.33	\$4,649.60	\$4,455.86	\$4,262.13	92
High Rel	8.5 - 11	30	1.75	6	27		12/800	EAR99	<a href="#">PE15A4063</a>	\$4,091.60	\$3,927.94	\$3,764.27	\$3,600.61	93
Power							15/900	EAR99	<a href="#">PE15A4006</a>	\$2,787.03	\$2,675.55	\$2,564.07	\$2,452.59	94
	Power	43	0.5	3	30		12/4,500	EAR99	<a href="#">PE15A4007</a>	\$3,823.22	\$3,670.29	\$3,517.36	\$3,364.43	95
15/1,500							EAR99	<a href="#">PE15A5021</a>	\$7,815.00	\$7,502.40	\$7,189.80	\$6,877.20	96	
High Rel	14.4 - 15.4	28	2.5	7	27		12/1,150	EAR99	<a href="#">PE15A4064</a>	\$9,510.00	\$9,129.60	\$8,749.20	\$8,368.80	97
High Rel, Power with Fan							12/1,730	EAR99	<a href="#">PE15A4064F</a>	\$10,043.33	\$9,641.60	\$9,239.86	\$8,838.13	98
Power	18 - 26.5	33	1.25	5	31		12/1,800	EAR99	<a href="#">PE15A4021</a>	\$4,233.28	\$4,063.95	\$3,894.62	\$3,725.29	99
High Rel							12/3,500	EAR99	<a href="#">PE15A5054</a>	\$12,042.04	\$11,560.36	\$11,078.68	\$10,597.00	1
High Rel, Power with Fan	18 - 40	35	3		33		12/4,660	EAR99	<a href="#">PE15A5054F</a>	\$12,664.71	\$12,158.12	\$11,651.53	\$11,144.94	2
High Rel							12/1,000	EAR99	<a href="#">PE15A4065</a>	\$11,107.87	\$10,663.56	\$10,219.24	\$9,774.93	3
High Rel, Power with Fan	18 - 40	3	4	9	23		12/1,580	EAR99	<a href="#">PE15A4065F</a>	\$11,509.68	\$11,049.29	\$10,588.91	\$10,128.52	4
Power							3	4.5	20	22	12/270	EAR99	<a href="#">PE15A4050</a>	\$3,067.12
High Rel	26.5 - 40	4	4	10		27	12/3,000	EAR99	<a href="#">PE15A4067</a>	\$12,632.25	\$12,190.12	\$11,747.99	\$11,369.03	6
High Rel, Power with Fan							12/3,160	EAR99	<a href="#">PE15A4067F</a>	\$13,894.59	\$13,408.28	\$12,921.97	\$12,505.13	7
High Rel	30 - 40	20	2		20		12/350	EAR99	<a href="#">PE15A4069</a>	\$8,068.55	\$7,745.81	\$7,423.07	\$7,100.32	8
High Rel, Power with Fan							12/930	EAR99	<a href="#">PE15A4069F</a>	\$8,660.00	\$8,313.60	\$7,967.20	\$7,620.80	9

## HIGH POWER AMPLIFIERS (>4W)



See Our Website For Current Pricing & Real-Time Stock Availability!

Amplifier Type	Frequency Band (GHz.)	Gain (dB)	Gain Var. ±(dB)	NF (dB)	P1dB (dBm)	Psat (dBm)	DC Power (V/mA)	ECCN	Model No	1	2-4	5-9	10+	ROW
High Power, Class AB	0.15 MHz - 230 MHz	43	1.5		41.8	44	28/5,000	EAR99	<a href="#">PE15A5028</a>	\$3,815.44	\$3,662.82	\$3,510.20	\$3,357.59	10
							28/5,500	EAR99	<a href="#">PE15A5028F</a>	\$4,740.57	\$4,550.95	\$4,361.32	\$4,171.70	11
							28/2,000	EAR99	<a href="#">PE15A5029</a>	\$2,477.19	\$2,378.10	\$2,279.01	\$2,179.93	12
High Power, Class AB, Power with Fan	0.5 MHz - 500 MHz	44	1.5		40	39	28/2,000	EAR99	<a href="#">PE15A5029F</a>	\$2,638.33	\$2,532.80	\$2,427.26	\$2,321.73	13
High Power, Class AB							20 MHz - 1	46	44	28/5,200	EAR99	<a href="#">PE15A5031</a>	\$3,908.32	\$3,751.99
High Power, Class AB, Power with Fan	500 MHz - 2.8 MHz	37	2	10	37	38.5				28/5,800	EAR99	<a href="#">PE15A5031F</a>	\$4,653.07	\$4,466.95
High Power							700 MHz - 2.2 MHz	30	1	3	12/1,800	EAR99	<a href="#">PE15A5013</a>	\$4,505.69
	800 MHz - 960 MHz	37	1	3	38		12/1,800	EAR99	<a href="#">PE15A5004</a>	\$2,376.28	\$2,293.11	\$2,209.94	\$2,138.65	17
							12/1,800	EAR99	<a href="#">PE15A5040</a>	\$1,334.90	\$1,281.50	\$1,228.11	\$1,174.71	18
							12/1,800	EAR99	<a href="#">PE15A5041</a>	\$1,399.86	\$1,343.87	\$1,287.87	\$1,231.88	19

# HIGH POWER AMPLIFIERS (>4W)



Amplifier Type	Frequency Band (GHz.)	Gain (dB)	Gain Var. ±(dB)	NF (dB)	P1dB (dBm)	Psat (dBm)	DC Power (V/mA)	ECCN	Model No	1	2-4	5-9	10+	ROW	
High Power, Class AB	800 MHz - 2	41	1.5		40	40.8	13/5,000	EAR99	<a href="#">PE15A5035</a>	\$4,585.85	\$4,402.42	\$4,218.98	\$4,035.55	20	
							13/5,500	EAR99	<a href="#">PE15A5035F</a>	\$4,799.69	\$4,607.70	\$4,415.71	\$4,223.73	21	
High Power, Class A	800 MHz - 2.5	40	2		41		12/5,500	EAR99	<a href="#">PE15A5020</a>	\$4,906.27	\$4,710.02	\$4,513.77	\$4,317.52	22	
High Power	860 MHz - 960 MHz	42	1	3.5			12/2,800	EAR99	<a href="#">PE15A5042</a>	\$2,847.79	\$2,733.88	\$2,619.97	\$2,506.06	23	
							12/6,500	EAR99	<a href="#">PE15A5039</a>	\$4,063.80	\$3,901.25	\$3,738.70	\$3,576.14	24	
High Power, Class AB, Power with Fan	1 - 2.5	40	1.5		39	40	13/5,500	EAR99	<a href="#">PE15A5036F</a>	\$5,207.92	\$4,999.60	\$4,791.29	\$4,582.97	25	
High Power, Class AB		44		41		13/5,000	EAR99	<a href="#">PE15A5036</a>	\$4,282.92	\$4,111.60	\$3,940.29	\$3,768.97	26		
Power, Class AB, Power with Fan	1 - 2.5	47	3		38	18	28/1,900	EAR99	<a href="#">PE15A5082</a>	\$6,607.04	\$6,210.62	\$5,880.27	\$5,615.98	27	
Power, Class AB		50		28/1,900			EAR99	<a href="#">PE15A5081</a>	\$5,607.04	\$5,270.62	\$4,990.27	\$4,765.98	28		
High Power, Class AB	1 - 3	44	1.5		37.8	39	13/3,000	EAR99	<a href="#">PE15A5037</a>	\$5,359.06	\$5,144.70	\$4,930.34	\$4,715.97	29	
High Power, Class AB, Power with Fan							13/4,000	EAR99	<a href="#">PE15A5037F</a>	\$6,363.88	\$6,109.32	\$5,854.77	\$5,600.21	30	
High Power	1.2 - 1.4	40	0.3	10	40		12/4,000	EAR99	<a href="#">PE15A5001</a>	\$4,135.53	\$3,970.11	\$3,804.69	\$3,639.27	31	
	1.5 - 3.5	20	1.25		38.5	39		EAR99	<a href="#">PE15A5005</a>	\$2,522.03	\$2,421.15	\$2,320.27	\$2,219.39	32	
	1.7 - 2	50	0.5		43			EAR99	<a href="#">PE15A5014</a>	\$4,290.60	\$4,118.98	\$3,947.35	\$3,775.73	33	
Power, Class AB	1.7 - 2.4	54	3		42	35	28/3,600	EAR99	<a href="#">PE15A5073</a>	\$4,617.41	\$4,340.37	\$4,109.49	\$3,924.80	34	
High Power	1.7 - 2.5	11	0.5		37		12/800	EAR99	<a href="#">PE15A5015</a>	\$2,531.47	\$2,430.21	\$2,328.95	\$2,227.69	35	
Power, Class AB	2 - 4	39	1.5		37.8	39	13/3,000	EAR99	<a href="#">PE15A5038</a>	\$5,543.44	\$5,321.70	\$5,099.96	\$4,878.23	36	
							13/5,500	EAR99	<a href="#">PE15A5038F</a>	\$6,038.39	\$5,796.85	\$5,555.32	\$5,313.78	37	
High Rel	2 - 6	40	3.5		37		12/7,000	EAR99	<a href="#">PE15A5047</a>	\$11,298.27	\$10,846.34	\$10,394.41	\$9,942.48	38	
High Rel, Power with Fan							12/8,160	EAR99	<a href="#">PE15A5047F</a>	\$12,376.47	\$11,881.41	\$11,386.35	\$10,891.29	39	
High Power							2.3 - 2.7	55	0.5	8	38	38.5	12/5,500	EAR99	<a href="#">PE15A5018</a>
	2.5 - 4	19	1	9	39	39		EAR99	<a href="#">PE15A5006</a>	\$1,607.67	\$1,543.36	\$1,479.06	\$1,414.75	41	
	2.6 - 4.2	8	0.5	37				EAR99	<a href="#">PE15A5007</a>	\$1,670.37	\$1,603.56	\$1,536.74	\$1,469.93	42	
	3.1 - 3.5	47	1.5	3.5	43			12/750	EAR99	<a href="#">PE15A5023</a>	\$2,896.15	\$2,780.30	\$2,664.46	\$2,548.61	43
		47	1.5	3.5	43			12/9,000	EAR99	<a href="#">PE15A5003</a>	\$4,135.53	\$3,970.11	\$3,804.69	\$3,639.27	44
	3.5 - 7	19	2	12	37	38			EAR99	<a href="#">PE15A5008</a>	\$2,971.54	\$2,852.68	\$2,733.82	\$2,614.96	45
		5.5 - 9.5	24	2	8.5				EAR99	<a href="#">PE15A5009</a>	\$2,940.58	\$2,822.96	\$2,705.33	\$2,587.71	46
High Rel	6 - 18	40	5		40		12/13,000	EAR99	<a href="#">PE15A5050</a>	\$20,395.29	\$19,681.45	\$18,967.62	\$18,355.76	47	
High Rel, Power with Fan							15/14,160	EAR99	<a href="#">PE15A5050F</a>	\$22,748.00	\$21,951.82	\$21,155.64	\$20,473.20	48	
High Rel							12/7,500	EAR99	<a href="#">PE15A5049</a>	\$17,182.03	\$16,580.66	\$15,979.29	\$15,463.83	49	
High Rel, Power with Fan							12/8,660	EAR99	<a href="#">PE15A5049F</a>	\$18,552.78	\$17,903.43	\$17,254.09	\$16,697.50	50	
High Rel							12/14,000	EAR99	<a href="#">PE15A5053</a>	\$17,036.70	\$16,440.42	\$15,844.13	\$15,333.03	51	
High Rel, Power with Fan	8 - 12	30	2.5		40		12/15,160	EAR99	<a href="#">PE15A5053F</a>	\$18,112.50	\$17,478.56	\$16,844.63	\$16,301.25	52	
High Rel							12/6,000	EAR99	<a href="#">PE15A5052</a>	\$12,634.99	\$12,129.59	\$11,624.19	\$11,118.79	53	
High Rel, Power with Fan							12/7,160	EAR99	<a href="#">PE15A5052F</a>	Call	Call	Call	Call	54	
High Power	8.5 - 10.5	36	1.5	5	38.5		12/4,000	EAR99	<a href="#">PE15A5044</a>	\$4,619.27	\$4,434.50	\$4,249.73	\$4,064.96	55	
	8.5 - 11	30	0.75				12/7,500	EAR99	<a href="#">PE15A5043</a>	\$4,258.37	\$4,088.04	\$3,917.70	\$3,747.37	56	
	17.5 - 21.5	40	1.5				12/3,500	EAR99	<a href="#">PE15A4020</a>	\$4,566.31	\$4,383.66	\$4,201.01	\$4,018.35	57	

Amplifiers

See Our Website For Current Pricing & Real-Time Stock Availability!

## GaN HIGH POWER



Amplifier Type	Frequency Band (GHz.)	Gain (dB)	Gain Var. ±(dB)	NF (dB)	P1dB (dBm)	Psat (dBm)	DC Power (V/mA)	ECCN	Model No	1	2-4	5-9	10+	ROW
High Power	30 MHz - 2.5	43	2			40	12/2,800	EAR99	<a href="#">PE15A5011</a>	\$7,728.39	\$7,419.25	\$7,110.12	\$6,800.98	58

Technical Support  
+1 (949) 261-1920

Same-Day Shipping,  
Even Custom  
Cable Assemblies

## GaN HIGH POWER



Amplifiers

Amplifier Type	Frequency Band (GHz.)	Gain (dB)	Gain Var. ±(dB)	NF (dB)	P1dB (dBm)	Psat (dBm)	DC Power (V/mA)	ECCN	Model No	1	2-4	5-9	10+	ROW
High Power	100 MHz - 6	60	1.25	10		40	28/2,200	EAR99	<a href="#">PE15A5027</a>	\$18,517.08	\$17,776.40	\$17,035.71	\$16,295.03	59
High Power, Class AB	500 MHz - 2.5	48	2	44	47	28/7,000	28/7,000	EAR99	<a href="#">PE15A5059</a>	\$5,426.67	\$5,101.07	\$4,829.74	\$4,612.67	60
		50				28/13,000	28/13,000	EAR99	<a href="#">PE15A5060</a>	\$12,596.67	\$11,840.87	\$11,211.04	\$10,707.17	61
High Power, Class AB, Power with Fan	500 MHz - 3	48	2	44	47	36/8,333	36/8,333	EAR99	<a href="#">PE15A5032</a>	\$15,550.00	\$14,928.00	\$14,306.00	\$13,684.00	62
						30/8,733	30/8,733	EAR99	<a href="#">PE15A5033</a>	\$14,518.19	\$13,937.46	\$13,356.73	\$12,776.01	64
High Power, Class AB, Power with Fan	700 MHz - 2.7	45	1.5			50	30/8,733	EAR99	<a href="#">PE15A5033F</a>	\$14,965.71	\$14,367.08	\$13,768.45	\$13,169.82	65
High Power	700 MHz - 6	43	2			40	32/2,000	EAR99	<a href="#">PE15A5017</a>	\$9,536.11	\$9,154.67	\$8,773.22	\$8,391.78	66
High Power, Class AB	800 MHz - 4.2	47	1.5	10	47	28/13,000	28/13,000	EAR99	<a href="#">PE15A5062</a>	\$8,253.33	\$7,758.13	\$7,345.46	\$7,015.33	67
		53				28/20,000	28/20,000	EAR99	<a href="#">PE15A5063</a>	\$10,056.67	\$9,453.27	\$8,950.44	\$8,548.17	68
High Power	1 - 3	50	1.25			47	28/4,000	EAR99	<a href="#">PE15A5026</a>	\$18,367.34	\$17,632.65	\$16,897.95	\$16,163.26	69
High Power, Class AB	1.2 - 1.6	48	2.5	7	43	28/8,000	28/8,000	EAR99	<a href="#">PE15A5064</a>	\$4,696.67	\$4,414.87	\$4,180.04	\$3,992.17	70
		43	2			28/5,000	28/5,000	EAR99	<a href="#">PE15A5066</a>	\$8,250.00	\$7,755.00	\$7,342.50	\$7,012.50	71
		46	2			28/6,000	28/6,000	EAR99	<a href="#">PE15A5067</a>	\$13,723.33	\$12,899.93	\$12,213.76	\$11,664.83	72
High Power	2 - 6	50	1.25			44	28/3,000	EAR99	<a href="#">PE15A5024</a>	\$15,110.08	\$14,581.23	\$14,052.37	\$13,599.07	73
		47	2	28/6,000	28/6,000	EAR99	<a href="#">PE15A5025</a>	\$18,958.61	\$18,200.27	\$17,441.92	\$16,683.58	74		
High Power, Class AB	2 - 18	37	3.5	7	43	37	22/2,500	EAR99	<a href="#">PE15A5068</a>	\$17,050.00	\$16,027.00	\$15,174.50	\$14,492.50	75
		43	2			43	24/7,000	EAR99	<a href="#">PE15A5069</a>	\$15,976.67	\$15,018.07	\$14,219.24	\$13,580.17	76
		40	3			40	28/3,000	EAR99	<a href="#">PE15A5070</a>	\$14,300.00	\$13,442.00	\$12,727.00	\$12,155.00	77
High Power	6.4 - 7.1	58	2	7	43	33/2,300	33/2,300	EAR99	<a href="#">PE15A5016</a>	\$9,585.87	\$9,202.44	\$8,819.00	\$8,435.57	78
						41.76	33/2,300	EAR99	<a href="#">PE15A5019</a>	\$9,194.12	\$8,826.36	\$8,458.59	\$8,090.83	79
High Power, Class AB	8 - 12	43	2	7	43	28/5,000	28/5,000	EAR99	<a href="#">PE15A5071</a>	\$11,283.33	\$10,606.33	\$10,042.16	\$9,590.83	80
		46				28/9,000	28/9,000	EAR99	<a href="#">PE15A5072</a>	\$18,050.00	\$16,967.00	\$16,064.50	\$15,342.50	81

## RACK MOUNT VARIABLE GAIN AMPLIFIERS



Amplifier Type	Frequency Band (GHz.)	Gain (dB)	Gain Var. ±(dB)	NF (dB)	Atten. Range (dB)	Step Size (dB)	AC Power (VAC)	ECCN	Model No	1	2-4	5-9	10+	ROW
Variable Gain, High Rel	100 MHz - 18	50	2	6.5	0-60	1	120	EAR99	<a href="#">PE15A7000</a>	\$17,332.07	\$16,638.79	\$15,945.50	\$15,252.22	82

## AMPLIFIER ACCESSORIES



Model No	Description	1 Pc. Price	See Web for Volume Pricing	ROW
<a href="#">PE15C5014</a>	Heat sink for amplifier models PE15A4011-4015 and PE15A5004-5009	\$640.72		83
<a href="#">PE15G5060F</a>	Heat Sink for amplifier models PE15A5055-5059, PE15A5064-5065, PE15A5068 and PE15A5070	\$706.67		84
<a href="#">PE15G5068F</a>	Heat Sink for amplifier models PE15A5060-5063, PE15A5066-5067, PE15A5069, PE15A5071-5072	\$883.33		85
<a href="#">PE15C5013</a>	Heat Sink for Most RF Power Amplifier PE15A5000 Series	\$451.11		86
<a href="#">PE15G5000</a>	Heat Sink for Most RF Power Amplifier PE15A5000 Series	Call		87
<a href="#">PE15C5022</a>	Heat Sink for Rf Power Amplifier PE15A5022	\$606.28		88
<a href="#">PE15C5013F</a>	Heat Sink with 12V Fan for Most RF Power Amplifier PE15A5000 Series	\$1,293.28	See Web for Volume Pricing	89
<a href="#">PE15G5000F</a>	Heat Sink with 12V Fan including Power and Control Cable for RF Amplifier PE15A5013, PE15A5010	Call		90
<a href="#">PE15G5013F</a>	Heat Sink with 12V Fan including Power and Control Cable for RF Amplifier PE15A5013, PE15A5010	Call		91
<a href="#">PE15C5011F</a>	Heat Sink with 24V Fan and Power and Control Cable for RF Amplifier PE15A5011, PE15A5016, PE15A5017, PE15A5019	\$1,129.20		92
<a href="#">PE15C5022F</a>	Heat Sink with 24V Fan for RF Power Amplifier PE15A5022	\$974.37		93
<a href="#">PE15G5012F</a>	Heat Sink with 24V Fan including Power and Control Cable for RF Amplifier PE15A5012, PE15A5021	Call		94

See Our Website For Current Pricing & Real-Time Stock Availability!

## AMPLIFIER ACCESSORIES



Model No	Description	1 Pc. Price	See Web for Volume Pricing	ROW
<a href="#">PE15G5011F</a>	Heat Sink with 24V Fan including Power and Control Cable for RF Power Amplifier PE15A5011, PE15A5016, PE15A5017, PE15A5019	Call	See Web for Volume Pricing	95
<a href="#">PE15A5990</a>	Heat Sink with Fan for RF Power Amplifier PE15A5024, PE15A5025 and PE15A5027	\$2,050.11		96
<a href="#">PE15J5011</a>	Power and Control Cable for RF Amplifier PE15A5011, PE15A5014, PE15A5016, PE15A5017, PE15A5018, PE15A5019, PE15A5020 and PE15A5022	\$231.99		97
<a href="#">PE15J5015</a>	Power and Control Cable for RF Amplifier PE15A5015, PE15A5023	\$125.04		98
<a href="#">PE15K5000</a>	Power and Control Cable for RF Amplifier PE15B5000 and PE15B5001	\$145.08		99
<a href="#">PE15K5002</a>	Power and Control Cable for RF Amplifier PE15B5002	\$117.75		1

Antennas

## INDEX GUIDE TO ANTENNAS

<b>ANTENNAS.....</b>	<b>57</b>
<b>DIRECTIONAL ANTENNAS.....</b>	<b>57</b>
Dish.....	58 Log..... 58
Fixed.....	58 Panel..... 57
Yagi.....	58 Sector..... 59
<b>OMNI DIRECTIONAL ANTENNAS.....</b>	<b>59</b>
Dome.....	59 Mobile..... 60
Duplexed Antenna Kits.....	63 Omni..... 62
Fixed.....	59 Portable..... 60
GPS Active.....	60 Rubber Duck..... 61
GPS Passive.....	60 Vehicular..... 62
<b>ANTENNA MOUNTS.....</b>	<b>63</b>

### Directional Antennas

#### Panel Antennas



RF Frequency Range (MHz)	VSWR	Gain Nominal	Polarization	Model No	1 Pc. Price	See Web for Volume Pricing	ROW
800 - 960 1,710 - 2,170	1.4:1	7 dBi	Vertical	<a href="#">PE51054</a>	Call	See Web for Volume Pricing	2
824 - 960	1.8:1	9 dBi	Vertical / Horizontal	<a href="#">PE51FP1006</a>	\$70.47		3
902 - 928	1.2:1		LHCP	<a href="#">PE51025</a>	\$155.87		4
	1.8:1		RHCP	<a href="#">PE51024</a>	\$162.23		5
		Vertical	<a href="#">PE51023</a>	\$274.12	6		
	1.5:1	8 dBi	Vertical / Horizontal	<a href="#">PE51FP1005</a>	\$74.14		7
2,300 - 2,500	1.6:1	9 dBi	LHCP	<a href="#">PE51FP1007</a>	\$61.97		8
			RHCP	<a href="#">PE51FP1008</a>	\$61.97		9
2,400 - 2,500	1.7:1	19 dBi	Vertical / Horizontal	<a href="#">PE51019-2</a>	Call		10
2,400 - 2,500 4,900 - 5,850	2:1	11 dBi	Vertical / Horizontal	<a href="#">PE51019-4</a>	Call		11
		14 dBi	Vertical / Horizontal	<a href="#">PE51049</a>	Call		12
	1.5:1	23 dBi	Vertical / Horizontal	<a href="#">PE51FP1003</a>	\$249.99		13
		10 dBi	Vertical / Horizontal	<a href="#">PE51FP1004</a>	\$180.75		14
4,900 - 5,850	1.5:1	10 dBi	Vertical / Horizontal	<a href="#">PE51FP1002</a>	\$182.30		15
	1.8:1	19 dBi	Vertical / Horizontal	<a href="#">PE51FP1001</a>	\$47.28		16
4,900 - 5,850	1.5:1	10 dBi	Vertical / Horizontal	<a href="#">PE51FP1010</a>	\$112.54		17
	1.8:1	19 dBi	Vertical / Horizontal	<a href="#">PE51FP1011</a>	\$114.78		18

## Panel Antennas



RF Frequency Range (MHz)	VSWR	Gain Nominal	Polarization	Model No	1 Pc. Price	See Web for Volume Pricing			ROW
5,725 - 5,850	1.5:1	19 dBi	Vertical / Horizontal	<a href="#">PE51050</a>	\$229.45				19
		22 dBi	Vertical / Horizontal	<a href="#">PE51052</a>	Call				20

## Fixed Antennas



RF Frequency Range (MHz)	VSWR	Gain Nominal	Polarization	Model No	1-4	5-9	10-24	25+	ROW
4,400 - 6,400	1.5:1	9 dBi	Vertical	<a href="#">PE51129</a>	\$523.07	\$502.15	\$486.46	\$475.99	21

## Yagi Antennas



RF Frequency Range (MHz)	VSWR	Gain Nominal	Polarization	Model No	1 Pc. Price	See Web for Volume Pricing			ROW	
824 - 960	1.5:1	3 dBi	Vertical / Horizontal	<a href="#">PE51YA1007</a>	\$37.50				22	
		6 dBi	Vertical / Horizontal	<a href="#">PE51YA1008</a>	\$41.66				23	
		9 dBi	Vertical / Horizontal	<a href="#">PE51YA1009</a>	\$46.16				24	
		12 dBi	Vertical / Horizontal	<a href="#">PE51YA1010</a>	\$49.53				25	
		14 dBi	Vertical / Horizontal	<a href="#">PE51YA1011</a>	\$59.09				26	
890 - 960	2.1:1	11 dBi	Vertical / Horizontal	<a href="#">PE51171</a>	\$354.84				27	
		9 dBi	Vertical / Horizontal	<a href="#">PE51YA1012</a>	\$48.41		See Web for Volume Pricing		28	
900 - 928	1.5:1	13 dBi	Vertical / Horizontal	<a href="#">PE51YA1013</a>	\$73.88					29
		14 dBi	Vertical / Horizontal	<a href="#">PE51YA1014</a>	\$163.18					30
2,400 - 2,483	1.5:1	12 dBi	Vertical	<a href="#">PE51YA1004</a>	\$61.97					31
2,400 - 2,500		9 dBi	Vertical / Horizontal	<a href="#">PE51YA1001</a>	\$66.53					32
		12 dBi	Vertical / Horizontal	<a href="#">PE51YA1002</a>	\$74.14					33
4,900 - 5,850		15 dBi	Vertical / Horizontal	<a href="#">PE51YA1003</a>	\$73.16					34
		17 dBi	Vertical / Horizontal	<a href="#">PE51YA1006</a>	\$203.68					35
5,725 - 5,825		17 dBi	Vertical	<a href="#">PE51YA1005</a>	\$93.31					36

## Dish Antennas



RF Frequency Range (MHz)	VSWR	Gain Nominal	Polarization	Model No	1-24	25-49	50-99	100+	ROW
2,400 - 2,500	1.5:1	18 dBi	H / V / 45 Deg. Slant	<a href="#">PE51PD1004</a>	\$157.55	\$149.67	\$141.80	\$135.49	37
		22 dBi	H / V / 45 Deg. Slant	<a href="#">PE51PD1005</a>	\$187.92	\$178.52	\$169.13	\$161.61	38
		25 dBi	H / V / 45 Deg. Slant	<a href="#">PE51PD1006</a>	\$339.83	\$322.84	\$305.85	\$292.25	39
4,750 - 5,850 5,400 - 5,800	1.5:1	30 dBi	H / V / 45 Deg. Slant	<a href="#">PE51PD1002</a>	\$200.30	\$190.29	\$180.27	\$172.26	40
		34 dBi	H / V / 45 Deg. Slant	<a href="#">PE51PD1003</a>	\$351.09	\$333.54	\$315.98	\$301.94	41
4,750 - 5,850		25 dBi	H / V / 45 Deg. Slant	<a href="#">PE51PD1001</a>	\$169.91	\$161.41	\$152.92	\$146.12	42

## Log Antennas

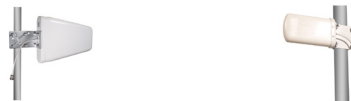

RF Frequency Range (MHz)	VSWR	Gain Nominal	Polarization	Model No	1-24	25-49	50-99	100+	ROW
698 - 960 1,710 - 2,500	1.6:1	10 dBi	Vertical / Horizontal	<a href="#">PE51LP1001</a>	\$82.16	\$78.05	\$73.94	\$70.66	43
2,400 - 6,500	1.5:1	8 dBi	Vertical	<a href="#">PE51LP1002</a>	\$88.91	\$84.46	\$80.02	\$76.46	44

## Sector Antennas



RF Frequency Range (MHz)	VSWR	Gain Nominal	Polarization	Model No	1-24	25-49	50-99	100+	ROW
698 - 960 1,710 - 2,700	1.6:1	14 dBi	Vertical	<a href="#">PE51SE1006</a>	\$373.85	\$355.16	\$336.47	\$321.51	45
	1.9:1	10 dBi	45 Deg. Slant	<a href="#">PE51SE1004</a>	\$241.95	\$229.85	\$217.76	\$208.08	46
	1.8:1	12 dBi	Vertical	<a href="#">PE51SE1005</a>	\$359.79	\$341.80	\$323.81	\$309.42	47
900 - 930	2:1	13 dBi	Horizontal	<a href="#">PE51SE1003</a>	\$286.95	\$272.60	\$258.26	\$246.78	48
902 - 928	1.5:1		Vertical / Horizontal	<a href="#">PE51FP1009</a>	\$399.00	\$379.05	\$359.10	\$343.14	49
2,400 - 2,500	1.3:1	20 dBi	Vertical	<a href="#">PE51SE1009</a>	\$483.88	\$459.69	\$435.49	\$416.14	50
	1.5:1	14 dBi	Vertical / Horizontal	<a href="#">PE51SE1001</a>	\$232.94	\$221.29	\$209.65	\$200.33	51
2,400 - 2,500 4,900 - 5,850	2:1	13 dBi	Vertical / Horizontal	<a href="#">PE51SE1002</a>	\$451.71	\$429.12	\$406.54	\$388.47	52
2,400 - 2,500 5,725 - 5,875	1.5:1	5 dBi	Vertical / Horizontal	<a href="#">PE51SE1007</a>	\$60.69	\$57.66	\$54.62	\$52.19	53
4,900 - 5,850	1.7:1	16 dBi	Vertical / Horizontal	<a href="#">PE51SE1008</a>	\$135.05	\$128.30	\$121.55	\$116.14	54

Antennas

## Omni Directional Antennas

### Dome Antennas



RF Frequency Range (MHz)	VSWR	Gain Nominal	Polarization	Model No	1 Pc. Price	See Web for Volume Pricing			ROW
698 - 960 1,710 - 2,700	1.7:1	5 dBi	Vertical	<a href="#">PE51158</a>	\$35.34	See Web for Volume Pricing			55
698 - 960 1,710 - 2,170	1.8:1	6 dBi	Vertical	<a href="#">PE51168</a>	Call				56
800 - 960 1,710 - 2,500	1.4:1	5 dBi	Vertical	<a href="#">PE51098-1</a>	Call				57
			Vertical	<a href="#">PE51098-2</a>	Call				58
			Vertical	<a href="#">PE51098-3</a>	Call				59
			Vertical	<a href="#">PE51098-4</a>	Call				60
800 - 3,000	2:1	3 dBi	Vertical	<a href="#">PE51057</a>	\$268.16				61
			Vertical	<a href="#">PE51059</a>	\$411.27				62
806 - 960 1,710 - 2,500	1.5:1	8 dBi	Vertical	<a href="#">PE51058</a>	\$330.55				63
			Vertical	<a href="#">PE51096</a>	\$47.50				64

See Our Website For Current Pricing & Real-Time Stock Availability!

### Fixed Antennas



RF Frequency Range (MHz)	VSWR	Gain Nominal	Polarization	Model No	1 Pc. Price	See Web for Volume Pricing			ROW
902 - 928	2:1	5 dBi	Vertical	<a href="#">PE51028</a>	\$224.59	See Web for Volume Pricing			65
2,250 - 2,350	1.43:1	3 dB	Vertical	<a href="#">PE51062</a>	\$132.05				66
2,350 - 2,450	1.3:1	3 dBi	Vertical	<a href="#">PE51063</a>	\$284.68				67
2,400 - 2,483	1.5:1	1 dBi	Vertical	<a href="#">PE51030</a>	Call				68
2,400 - 2,500	2:1	8 dBi	Vertical	<a href="#">PE51061</a>	\$262.52				69
	2.1:1		Vertical	<a href="#">PE51172</a>	\$163.34				70
2,450 - 2,550	1.43:1	3 dB	Vertical	<a href="#">PE51064</a>	\$156.55				71
3,400 - 3,600	1.5:1	9 dBi	Vertical	<a href="#">PE51033</a>	Call				72
		11 dBi	Vertical	<a href="#">PE51034</a>	\$103.39				73
3,450 - 3,550	1.4:1	3 dBi	Vertical	<a href="#">PE51065</a>	\$134.57				74
5,470 - 5,725	1.5:1	1 dBi	Vertical	<a href="#">PE51036</a>	Call	75			
		12 dBi	Vertical	<a href="#">PE51037</a>	\$82.42	76			
5,725 - 5,850			Vertical	<a href="#">PE51040</a>	\$117.07	77			

## GPS Active Antennas



RF Frequency Range (MHz)	VSWR	Gain Nominal	Polarization	Model No	1 Pc. Price	See Web for Volume Pricing			ROW
1,570 - 1,580	1.3:1	32 dBic	RHCP	<a href="#">PE51067</a>	\$380.36				78
1,574 - 1,610	2:1	32 dBi		<a href="#">PE51TM1000</a>	\$161.05				79

## GPS Passive Antennas



RF Frequency Range (MHz)	VSWR	Gain Nominal	Polarization	Model No	1 Pc. Price	See Web for Volume Pricing			ROW
1,220 - 1,230 1,530 - 1,580	2:1	6 dBic	RHCP	<a href="#">PE51068</a>	\$1,054.12	See Web for Volume Pricing			80
1,572.42 - 1,578.42	1.5:1	3 dBi	RHCP	<a href="#">PE51066-1</a>	\$129.67				81
			RHCP	<a href="#">PE51066-2</a>	\$99.74				82
1,575 - 1,615	2:1	3 dB	RHCP	<a href="#">PE51GPS1004</a>	\$28.85				83

## Mobile Antennas



RF Frequency Range (MHz)	VSWR	Gain Nominal	Polarization	Model No	1 Pc. Price	See Web for Volume Pricing			ROW
40 - 47	1.5:1	0 dBi	Vertical	<a href="#">PE51000</a>	Call	See Web for Volume Pricing			84
118 - 940	1.5:1		Vertical	<a href="#">PE51001</a>	\$23.14				85
132 - 512	2:1	5 dBi	Vertical	<a href="#">PE51003</a>	Call				86
440 - 480			Vertical	<a href="#">PE51170</a>	Call				87
474.5 - 479.5	1.5:1	6 dBic	Vertical	<a href="#">PE51060</a>	\$119.95				88
806 - 950 1,850 - 1,900	2:1	3 dBi	Vertical	<a href="#">PE51013</a>	Call				89
824 - 896 1,850 - 1,990	1.5:1	2 dBi	Vertical	<a href="#">PE51014</a>	Call				90
825 - 896		5 dB	Vertical	<a href="#">PE51009</a>	Call				91
870 - 950		5 dBi	Vertical	<a href="#">PE51010</a>	Call				92
880 - 965 1,710 - 2,170	2:1	3 dBi	Vertical	<a href="#">PE51113-1</a>	\$50.19				93
			Vertical	<a href="#">PE51113-2</a>	\$55.56				94
			Vertical	<a href="#">PE51113-3</a>	\$43.60				95
			Vertical	<a href="#">PE51113-4</a>	\$45.40				96
900 - 960 2,400 - 2,500	1.5:1		Vertical	<a href="#">PE51MO1001</a>	\$70.44				97
			Vertical	<a href="#">PE51MO1002</a>	\$63.93	98			
902 - 928	2:1	4 dBi	Vertical	<a href="#">PE51027</a>	\$41.12	99			
2,400 - 2,500 900 - 960	1.5:1	3 dBi	Vertical	<a href="#">PE51OM1022</a>	\$91.84	1			
			Vertical	<a href="#">PE51MO1003</a>	\$89.36	2			
			Vertical	<a href="#">PE51OM1023</a>	\$86.62	3			
2,400 - 2,500		3 dB	Vertical	<a href="#">PE51136</a>	\$114.24	4			

## Portable Antennas



RF Frequency Range (MHz)	VSWR	Gain Nominal	Polarization	Model No	1 Pc. Price	See Web for Volume Pricing			ROW
118 - 174	2:1	dBi	Vertical	<a href="#">PE51TW1000</a>	\$31.15	See Web for Volume Pricing			5
400 - 420		2 dBi	Vertical	<a href="#">PE51145</a>	Call				6
		Vertical	<a href="#">PE51146</a>	\$20.98	7				
420 - 450		dBi	Vertical	<a href="#">PE51159</a>	\$24.21				8
		Vertical	<a href="#">PE51160</a>	\$16.19	9				
450 - 470		Vertical	<a href="#">PE51148</a>	\$25.16	10				



### Portable Antennas



RF Frequency Range (MHz)	VSWR	Gain Nominal	Polarization	Model No	1 Pc. Price	See Web for Volume Pricing	ROW	
450 - 470	2:1	dBi	Vertical	<a href="#">PE51149</a>	Call	See Web for Volume Pricing	11	
470 - 512			Vertical	<a href="#">PE51161</a>	\$19.42		12	
482 - 512	1.5:1		Vertical	<a href="#">PE51162</a>	\$16.19		13	
			Vertical	<a href="#">PE51147</a>	\$15.38		14	
698 - 780	2:1	Vertical	<a href="#">PE51153</a>	\$16.40	15			
		Vertical	<a href="#">PE51157</a>	\$18.74	16			
698 - 870	2.2:1	2 dBi	Vertical	<a href="#">PE51152</a>	\$19.96		17	
			Vertical	<a href="#">PE51150</a>	\$20.18		18	
	2.3:1		Vertical	<a href="#">PE51154</a>	\$24.58		19	
	2.5:1		Vertical	<a href="#">PE51151</a>	\$20.18		20	
760 - 870	2:1	dBi	Vertical	<a href="#">PE51163</a>	\$15.77		21	
			Vertical	<a href="#">PE51166</a>	\$22.48		22	
Vertical		<a href="#">PE51155</a>	\$16.40	23				
Vertical		<a href="#">PE51156</a>	\$23.95	24				
806 - 880		2:1	dBi	Vertical	<a href="#">PE51164</a>		\$15.77	25
				Vertical	<a href="#">PE51165</a>		\$19.20	26
880 - 960		2:1	3 dBi	Vertical	<a href="#">PE51089-1</a>		\$43.22	27
				Vertical	<a href="#">PE51089-2</a>		\$37.44	28
Vertical			<a href="#">PE51089-3</a>	\$35.58	29			
Vertical			<a href="#">PE51089-4</a>	\$35.80	30			
900 - 960	1.5:1	dBi	Vertical	<a href="#">PE51056</a>	\$46.68		31	
902 - 928	2.1:1	3 dBi	Vertical	<a href="#">PE51055</a>	\$93.51		32	
			Vertical	<a href="#">PE51026</a>	\$23.12		33	
1,700 - 1,850	2:1	4 dBi	Vertical	<a href="#">PE51119</a>	\$524.74		34	
			Vertical	<a href="#">PE51120</a>	\$554.86		35	
1,700 - 2,500		2 dBi	Vertical	<a href="#">PE51117A</a>	\$713.60		36	
			Vertical	<a href="#">PE51173</a>	\$437.89	37		
1,900 - 2,500		4 dBi	Vertical	<a href="#">PE51121</a>	\$678.77	38		
			Vertical	<a href="#">PE51122</a>	\$543.56	39		
2,200 - 2,500		6 dBi	Vertical	<a href="#">PE51123</a>	\$588.66	40		
			Vertical	<a href="#">PE51124</a>	\$460.60	41		
2,300 - 2,700		7 dBi	Vertical	<a href="#">PE51090</a>	\$16.17	42		
2,400 - 2,483.5			2 dBi	Vertical	<a href="#">PE51018</a>	Call	43	
2,400 - 2,500	1.43:1	3 dBi	Vertical	<a href="#">PE51133</a>	\$182.80	44		
		2 dBi	Vertical / Horizontal	<a href="#">PE51077</a>	\$35.75	45		
	2:1	3 dBi	Vertical	<a href="#">PE51076</a>	\$34.06	46		
		6 dBi	Vertical	<a href="#">PE51078</a>	\$21.01	47		
2,400 - 2,500 4,900 - 5,800	2:1	3 dBi	Vertical	<a href="#">PE51087</a>	\$26.74	48		
2,400 - 2,500 4,900 - 5,100		2.5:1	Vertical	<a href="#">PE51088</a>	\$35.75	49		
2,400 - 2,500 4,900 - 5,825	2:1	2 dBi	Vertical	<a href="#">PE51080</a>	\$31.01	50		
			Vertical	<a href="#">PE51082</a>	\$22.82	51		
			Vertical	<a href="#">PE51083</a>	\$19.13	52		
3,300 - 3,800	2 dBi	3 dBi	Vertical	<a href="#">PE51081</a>	\$23.36	53		
			Vertical	<a href="#">PE51072</a>	\$28.13	54		
3,400 - 3,800	5 dBi	2 dBi	Vertical	<a href="#">PE51084</a>	\$33.35	55		
			Vertical	<a href="#">PE51085</a>	\$18.64	56		
4,400 - 5,000	6 dBi	5 dBi	Vertical	<a href="#">PE51135A</a>	\$536.34	57		
			Vertical	<a href="#">PE51134</a>	\$843.62	58		
5,100 - 5,900	2:1	5 dBi	Vertical	<a href="#">PE51070</a>	Call	59		
5,250 - 5,850			4 dBi	Vertical	<a href="#">PE51125A</a>	\$530.21	60	
		Vertical		<a href="#">PE51126</a>	\$456.16	61		
		6 dBi	Vertical	<a href="#">PE51127</a>	\$556.26	62		
			Vertical	<a href="#">PE51128</a>	\$456.16	63		
2,400 - 2,500 5,000 - 5,900		4 dBi	Vertical	<a href="#">PE51142</a>	\$28.09	64		
			Vertical	<a href="#">PE51143</a>	\$18.01	65		
				Vertical	<a href="#">PE51144</a>	\$17.33	66	

Antennas

See Our Website For Current Pricing & Real-Time Stock Availability!

### Rubber Duck Antennas



RF Frequency Range (MHz)	VSWR	Gain Nominal	Polarization	Model No	1-24	25-49	50-99	100+	ROW
2,400 - 2,500	2:1	6 dBi	Vertical	<a href="#">PE51RD1007</a>	\$13.64	\$12.96	\$12.28	\$11.73	67



Technical Support  
+1 (949) 261-1920



Same-Day Shipping,  
Even Custom Cable Assemblies

### Rubber Duck Antennas



RF Frequency Range (MHz)	VSWR	Gain Nominal	Polarization	Model No	1-24	25-49	50-99	100+	ROW
2,400 - 2,500 4,900 - 5,350 5,725 - 5,850	2:1	3 dBi	Vertical	<a href="#">PE51RD1002</a>	\$18.59	\$17.66	\$16.73	\$15.99	68
			Vertical	<a href="#">PE51RD1004</a>	\$18.76	\$17.82	\$16.88	\$16.13	69
			Vertical	<a href="#">PE51RD1003</a>	\$19.13	\$18.17	\$17.22	\$16.45	70
2,400 - 2,500 5,150 - 5,850	2:1	5 dBi	Vertical	<a href="#">PE51RD1006</a>	\$30.39	\$28.87	\$27.35	\$26.14	71
2,400 - 2,483 5,100 - 5,900		3 dBi	Vertical	<a href="#">PE51RD1005</a>	\$23.64	\$22.46	\$21.28	\$20.33	72

### Vehicular Antennas



RF Frequency Range (MHz)	VSWR	Gain Nominal	Polarization	Model No	1-24	25-49	50-99	100+	ROW
108 - 520	2:1	2 dBi	Linear, Vertical	<a href="#">PE51MP1000</a>	\$54.54	\$50.72	\$46.90	\$43.63	73
132 - 174	1.5:1	3 dBi	Linear, Vertical	<a href="#">PE51MP1001</a>	\$68.08	\$63.31	\$58.55	\$54.46	74
	2:1	2 dBi	Linear, Vertical	<a href="#">PE51MP1002</a>	\$74.44	\$69.23	\$64.02	\$59.55	75
144 - 174	1.5:1	3 dBi	Linear, Vertical	<a href="#">PE51MP1004</a>	\$68.08	\$63.31	\$58.55	\$54.46	76
			Linear, Vertical	<a href="#">PE51MP1003</a>	\$99.23	\$92.28	\$85.34	\$79.38	77
	2:1	2 dBi	Linear, Vertical	<a href="#">PE51MP1009</a>	\$74.44	\$69.23	\$64.02	\$59.55	78
380 - 520	1.5:1	3 dBi	Linear, Vertical	<a href="#">PE51MP1005</a>	\$68.33	\$63.55	\$58.76	\$54.66	79
420 - 470			Linear, Vertical	<a href="#">PE51MP1006</a>	\$61.74	\$57.42	\$53.10	\$49.39	80
440 - 480	2:1	5 dBi	Linear, Vertical	<a href="#">PE51MP1007</a>	\$72.13	\$67.08	\$62.03	\$57.70	81
		3 dBd	Linear, Vertical	<a href="#">PE51MP1008</a>	\$77.13	\$71.73	\$66.33	\$61.70	82
450 - 520 746 - 960	2:1	2 dBi	Linear, Vertical	<a href="#">PE51MP1011</a>	\$73.85	\$68.68	\$63.51	\$59.08	83
698 - 960 1,710 - 2,150		3 dBi	Linear, Vertical	<a href="#">PE51MP1010</a>	\$62.31	\$57.95	\$53.59	\$49.85	84
824 - 960 1,710 - 1,990		2 dBi	Vertical	<a href="#">PE51GM1001</a>	\$17.98	\$16.72	\$15.46	\$14.38	85

### Omni Antennas



RF Frequency Range (MHz)	VSWR	Gain Nominal	Polarization	Model No	1-24	25-49	50-99	100+	ROW
698 - 960 1,710 - 2,700	1.6:1	4 dBi	Vertical	<a href="#">PE51OM1020</a>	\$55.68	\$52.90	\$50.11	\$47.88	86
824 - 928 900 - 928	1.7:1	9 dBi	Vertical / Horizontal	<a href="#">PE51OM1021</a>	\$750.00	\$712.50	\$675.00	\$645.00	87
			3 dBi	Vertical	<a href="#">PE51OM1013</a>	\$67.53	\$64.15	\$60.78	\$58.08
824 - 960	1.5:1	6 dBi	Vertical	<a href="#">PE51OM1014</a>	\$74.67	\$70.94	\$67.20	\$64.22	89
			Vertical	<a href="#">PE51OM1015</a>	\$114.80	\$109.06	\$103.32	\$98.73	90
			Vertical	<a href="#">PE51OM1016</a>	\$167.18	\$158.82	\$150.46	\$143.77	91
			Vertical	<a href="#">PE51OM1019</a>	\$118.06	\$112.16	\$106.25	\$101.53	92
			Vertical	<a href="#">PE51OM1017</a>	\$70.44	\$66.92	\$63.40	\$60.58	93
900 - 928	1.6:1	8 dBi	Vertical	<a href="#">PE51OM1018</a>	\$86.70	\$82.37	\$78.03	\$74.56	94
			Vertical	<a href="#">PE51OM1025</a>	\$113.68	\$108.00	\$102.31	\$97.76	95
			Vertical	<a href="#">PE51OM1026</a>	\$83.19	\$79.03	\$74.87	\$71.54	96
			Vertical	<a href="#">PE51OM1024</a>	\$87.78	\$83.39	\$79.00	\$75.49	97
			Vertical / Horizontal	<a href="#">PE51OM1009</a>	\$231.68	\$220.10	\$208.51	\$199.24	98
2,400 - 2,500 5,100 - 5,800	1.6:1	6 dBi	Vertical / Horizontal	<a href="#">PE51OM1007</a>	\$281.31	\$267.24	\$253.18	\$241.93	99
			Vertical / Horizontal	<a href="#">PE51OM1008</a>	\$337.59	\$320.71	\$303.83	\$290.33	1
			Vertical / Horizontal	<a href="#">PE51OM1010</a>	\$286.83	\$272.49	\$258.15	\$246.67	2
			Vertical / Horizontal	<a href="#">PE51OM1011</a>	\$355.68	\$337.90	\$320.11	\$305.88	3
			Vertical	<a href="#">PE51OM1001</a>	\$46.16	\$43.85	\$41.54	\$39.70	4
2,400 - 2,500 4,900 - 5,850	1.5:1	6 dBi	Vertical	<a href="#">PE51OM1004</a>	\$123.79	\$117.60	\$111.41	\$106.46	5
	1.6:1	9 dBi	Vertical	<a href="#">PE51OM1005</a>	\$135.05	\$128.30	\$121.55	\$116.14	6
2,400 - 2,500 4,900 - 5,850	1.8:1	4 dBi	Vertical	<a href="#">PE51OM1012</a>	\$151.92	\$144.32	\$136.73	\$130.65	7

Antennas

See Our Website For Current Pricing & Real-Time Stock Availability!

### Omni Antennas



RF Frequency Range (MHz)	VSWR	Gain Nominal	Polarization	Model No	1-24	25-49	50-99	100+	ROW
2,400 - 2,500 4,900 - 5,850	2.5:1	6 dBi	Vertical	<a href="#">PE51OM1002</a>	\$54.03	\$51.33	\$48.63	\$46.47	8
		8 dBi	Vertical	<a href="#">PE51OM1003</a>	\$63.03	\$59.88	\$56.73	\$54.21	9
2,400 - 2,500 5,100 - 5,900	1.8:1	6 dBi	Vertical / Horizontal	<a href="#">PE51OM1006</a>	\$225.06	\$213.81	\$202.55	\$193.55	10

### Duplexed Antenna Kits Antennas



RF Frequency Range (MHz)	VSWR	Contains	Model No	1-24	25-49	50-99	100+	ROW
100 - 180 380 - 520	1.6:1	Duplexer (VHF/UHF 108-174 MHz/380-870 MHz), with integral N-type (m) Connectors (3 ea.); Low Loss 195 NMO mount with cable (1 ea.); RG-58/U NMO mount with cable (1 ea.); Field Tunable Antennas (2 ea.)/RG-58/U Feed Cable (1 ea.)	<a href="#">PE51AK1000</a>	\$256.15	\$238.22	\$220.29	\$204.92	11
		Duplexer (VHF/UHF 108-174MHz/380-870MHz) with integral N-Type (m) Connectors (3 ea.); Low Loss PE51GPS1000 NMO Combination mount with integrated GPS antenna (1 ea.); RG-58/U NMO mount (1 ea.); Field Tunable Antennas (2 ea.); RG-58/U Feed Cable (1 ea.); PE51GPS1000 NMO Combination mount with integrated GPS antenna	<a href="#">PE51AK1001</a>	\$327.69	\$304.75	\$281.81	\$262.15	12
		Duplexer (VHF/UHF 108-174MHz/450-520MHz/746-870MHz) with integral N-Type (m) Connectors (3 ea.); Low Loss PE51GPS1000 NMO Combination mount with integrated GPS antenna (1 ea.); RG-58/U NMO mount (1 ea.); PE51MP1011 multiband antenna (1 ea.); PE51MP1000 tunable VHF/UHF antenna (1 ea.)/RG-58/U Feed Cable (1 ea.)	<a href="#">PE51AK1002</a>	\$426.92	\$397.04	\$367.15	\$341.54	13
		Duplexer (VHF/UHF 108-174MHz/450-520MHz/746-870MHz) with integral N-type (m) Connectors (3 ea.); Low loss 195 NMO mount (1 ea.); RG-58/U NMO mount (1 ea.); PE51MP1011 multiband antenna (1 ea.); PE51MP1000 tunable VHF/UHF antenna (1 ea.); RG-58/U Feed Cable (1 ea.)	<a href="#">PE51AK1003</a>	\$338.46	\$314.77	\$291.08	\$270.77	14

### Antenna Mounts



RF Frequency Range (MHz)	VSWR	Gain Nominal	Description	Model No	1-24	25-49	50-99	100+	ROW
0 - 0	1.2:1		Ground Plane Converter Kit, NMO to N Female for pole mounting	<a href="#">PE51AK1004</a>	\$46.15	\$42.92	\$39.69	\$36.92	15
	2:1	3 dB	NMO Mount Combo 30 dB GPS Vehicular Antenna NMO Mount/SMA Connectors RG58 cable	<a href="#">PE51GPS1000</a>	\$126.92	\$118.04	\$109.15	\$101.54	16
			NMO Mount Combo 30 dB GPS Vehicular Antenna NMO Mount/SMA Connectors LL195 cable	<a href="#">PE51GPS1001</a>	\$144.23	\$134.13	\$124.04	\$115.38	17
1,575 - 1,615	2:1	28 dB	NMO Mount Combo 28 dB GPS/GLNSS Vehicular Antenna NMO Mount/SMA Connectors RG58 cable	<a href="#">PE51GPS1002</a>	\$126.92	\$118.04	\$109.15	\$101.54	18
			NMO Mount Combo 28 dB GPS/GLNSS Vehicular Antenna NMO Mount/SMA Connectors LL195 cable	<a href="#">PE51GPS1003</a>	\$144.23	\$134.13	\$124.04	\$115.38	19
1,574 - 1,610	2:1	32 dBi	32 dBi Mount Kit and Timing GPS/GLNSS Antenna 1,574-1,610 MHz TNC Connector	<a href="#">PE51TM1001</a>	\$196.05	\$182.33	\$168.60	\$156.84	20

Antennas

See Our Website For Current Pricing & Real-Time Stock Availability!

# Attenuators and Equalizers Selection Guide

## 3 Easy Ways to Find your Product.....

### 1. Search by PE Part Number

If you know the PE part number you are searching for, please reference our Part Number Index on Page [355](#).

### 2. Quick Reference Guide

Attenuators.....	<a href="#">66</a>
CMOS, Relay, TTL and USB Controlled Attenuators.....	<a href="#">81</a>
Continuously Variable Attenuators	
50 Ohm.....	<a href="#">81</a>
DC Bias Attenuators	
50 Ohm.....	<a href="#">81</a>
75 Ohm.....	<a href="#">81</a>
Fixed Attenuators	
50 Ohm.....	<a href="#">66</a>
75 Ohm.....	<a href="#">78</a>
Step Attenuators, Push Button	
50 Ohm.....	<a href="#">79</a>
75 Ohm.....	<a href="#">80</a>
Step Attenuators, Rotary	
50 Ohm.....	<a href="#">80</a>
75 Ohm.....	<a href="#">80</a>
Step Attenuators, Toggle	
75 Ohm.....	<a href="#">80</a>
Voltage Variable Attenuators.....	<a href="#">82</a>
Equalizers.....	<a href="#">82</a>

### 3. Attenuators Locator

Connector In-Out	Max Freq.	Power	Model No.	Page
<b>1.85mm Male</b>				
1.85mm Female	65 GHz	1 W	<a href="#">PE7403</a>	<a href="#">66</a>
<b>2.4mm Female</b>				
2.4mm Female	40 GHz	0.25 W	<a href="#">PE70A6001</a>	<a href="#">82</a>
<b>2.4mm Male</b>				
2.4mm Female	50 GHz	1 W	<a href="#">PE7089</a>	<a href="#">66</a>
<b>2.92mm Female</b>				
2.92mm Female	18 GHz	0.25 W	<a href="#">PE70A5001</a>	<a href="#">82</a>
		0.1 W	<a href="#">PE70A3901</a>	<a href="#">82</a>
		0.25 W	<a href="#">PE70A5002</a>	<a href="#">82</a>
2.92mm Female	40 GHz	0.5 W	<a href="#">PE7024</a>	<a href="#">67</a>
		1 W	<a href="#">PE7024/SP</a>	<a href="#">67</a>
		2 W	<a href="#">PE7AP412</a>	<a href="#">66</a>
2.92mm Female	40 GHz	0.5 W	<a href="#">PE7046</a>	<a href="#">66</a>
		1 W	<a href="#">PE7088</a>	<a href="#">66</a>
		2 W	<a href="#">PE7090</a>	<a href="#">67</a>
		5 W	<a href="#">PE7395</a>	<a href="#">67</a>
		10 W	<a href="#">PE7AP402</a>	<a href="#">71</a>
<b>4.3-10 Male</b>				
4.3-10 Female	6 GHz	15 W	<a href="#">PE7AP1001</a>	<a href="#">72</a>
<b>7/16 DIN Female</b>				
7/16 DIN Female	6 GHz	25 W	<a href="#">PE7380</a>	<a href="#">72</a>
		50 W	<a href="#">PE7313</a>	<a href="#">74</a>
		100 W	<a href="#">PE7204</a>	<a href="#">76</a>

Connector In-Out	Max Freq.	Power	Model No.	Page
<b>7/16 DIN Female</b>				
7/16 DIN Male	6 GHz	50 W	<a href="#">PE7310</a>	<a href="#">74</a>
		100 W	<a href="#">PE7201</a>	<a href="#">76</a>
N Female	6 GHz	50 W	<a href="#">PE7321</a>	<a href="#">74</a>
		100 W	<a href="#">PE7316</a>	<a href="#">74</a>
N Male	6 GHz	50 W	<a href="#">PE7212</a>	<a href="#">76</a>
		100 W	<a href="#">PE7207</a>	<a href="#">76</a>
<b>7/16 DIN Male</b>				
7/16 DIN Female	1.5 GHz	100 W	<a href="#">PE7043</a>	<a href="#">75</a>
		25 W	<a href="#">PE7379</a>	<a href="#">72</a>
		50 W	<a href="#">PE7312</a>	<a href="#">73</a>
	7.5 GHz	100 W	<a href="#">PE7203</a>	<a href="#">75</a>
		5 W	<a href="#">PE7039</a>	<a href="#">70</a>
		10 W	<a href="#">PE7040</a>	<a href="#">71</a>
		25 W	<a href="#">PE7041</a>	<a href="#">72</a>
N Female	6 GHz	50 W	<a href="#">PE7042</a>	<a href="#">73</a>
		100 W	<a href="#">PE7211</a>	<a href="#">75</a>
<b>BNC Female</b>				
BNC Female	0.5 GHz	1 W	<a href="#">PE7035</a>	<a href="#">80</a>
			<a href="#">PE70A1001</a>	<a href="#">80</a>
	1 GHz	2 W	<a href="#">PE7034</a>	<a href="#">80</a>
			<a href="#">PE70A1024</a>	<a href="#">80</a>
	2.2 GHz	2 W	<a href="#">PE70A1022</a>	<a href="#">80</a>
			<a href="#">PE7008</a>	<a href="#">80</a>
DC-500	1 W	<a href="#">PE7008</a>	<a href="#">80</a>	
		<a href="#">PE70A1021</a>	<a href="#">79</a>	

# Attenuators Locator

Connector In-Out	Max Freq.	Power	Model No.	Page
<b>BNC Male</b>				
BNC Female	1 GHz	1 W	<a href="#">PE7009</a>	<a href="#">78</a>
		100 W	<a href="#">PE7026</a>	<a href="#">76</a>
	2 GHz	1 W	<a href="#">PE7000</a>	<a href="#">66</a>
		10 W	<a href="#">PE7025</a>	<a href="#">71</a>
	4 GHz	2 W	<a href="#">PE7049</a>	<a href="#">68</a>
			<a href="#">PE7050</a>	<a href="#">79</a>
<b>F Female</b>				
F Female	1 GHz	1 W	<a href="#">PE70A1008</a>	<a href="#">80</a>
			<a href="#">PE70A8003</a>	<a href="#">81</a>
			<a href="#">PE70A8004</a>	<a href="#">81</a>
	2.15 GHz	0 W	<a href="#">PE70A5011</a>	<a href="#">82</a>
		30 W	<a href="#">PE70A5012</a>	<a href="#">82</a>
<b>F Male</b>				
F Female	1 GHz	2 W	<a href="#">PE7057</a>	<a href="#">79</a>
	2 GHz		<a href="#">PE7064</a>	<a href="#">81</a>
	3 GHz		<a href="#">PE7396</a>	<a href="#">79</a>
<b>N Female</b>				
7/16 DIN Female	6 GHz	25 W	<a href="#">PE7369</a>	<a href="#">73</a>
		50 W	<a href="#">PE7315</a>	<a href="#">75</a>
		100 W	<a href="#">PE7206</a>	<a href="#">77</a>
7/16 DIN Male	6 GHz	25 W	<a href="#">PE7370</a>	<a href="#">73</a>
		50 W	<a href="#">PE7311</a>	<a href="#">75</a>
		100 W	<a href="#">PE7202</a>	<a href="#">77</a>
N Female	18 GHz	25 W	<a href="#">PE7371</a>	<a href="#">73</a>
		50 W	<a href="#">PE7323</a>	<a href="#">75</a>
	3 GHz	300 W	<a href="#">PE7411</a>	<a href="#">78</a>
N Male	18 GHz	50 W	<a href="#">PE7317</a>	<a href="#">75</a>
		6 GHz	100 W	<a href="#">PE7208</a>
	18 GHz	25 W	<a href="#">PE7372</a>	<a href="#">73</a>
<b>N Male</b>				
7/16 DIN Female	6 GHz	25 W	<a href="#">PE7366</a>	<a href="#">72</a>
		50 W	<a href="#">PE7314</a>	<a href="#">74</a>
		100 W	<a href="#">PE7205</a>	<a href="#">76</a>
N Female	1 GHz	1 W	<a href="#">PE7029</a>	<a href="#">79</a>
		300 W	<a href="#">PE7031</a>	<a href="#">78</a>
		500 W	<a href="#">PE7032</a>	<a href="#">78</a>
			<a href="#">PE7084</a>	<a href="#">78</a>
			<a href="#">PE7021</a>	<a href="#">76</a>
	1.5 GHz	100 W	<a href="#">PE7021</a>	<a href="#">76</a>
		12.4 GHz	10 W	<a href="#">PE7048</a>
	18 GHz	2 W	<a href="#">PE7004</a>	<a href="#">68</a>
			<a href="#">PE7047</a>	<a href="#">68</a>
		5 W	<a href="#">PE7014</a>	<a href="#">70</a>
			<a href="#">PE7015</a>	<a href="#">71</a>
			<a href="#">PE7017</a>	<a href="#">72</a>
	25 W	<a href="#">PE7367</a>	<a href="#">72</a>	
		<a href="#">PE7019</a>	<a href="#">74</a>	
		<a href="#">PE7322</a>	<a href="#">74</a>	
	2 GHz	2 W	<a href="#">PE7062</a>	<a href="#">81</a>
		10 W	<a href="#">PE7010</a>	<a href="#">71</a>
	2.4 GHz	500 W	<a href="#">PE7085</a>	<a href="#">78</a>
	2.5 GHz	1000 W	<a href="#">PE7423</a>	<a href="#">78</a>
	3 GHz	1 W	<a href="#">PE7002</a>	<a href="#">67</a>
<a href="#">PE7390</a>			<a href="#">70</a>	
<a href="#">PE7386</a>			<a href="#">71</a>	
50 W		<a href="#">PE7388</a>	<a href="#">74</a>	
		<a href="#">PE7389</a>	<a href="#">74</a>	
100 W		<a href="#">PE7385</a>	<a href="#">76</a>	
		<a href="#">PE7387</a>	<a href="#">78</a>	
4 GHz	2 W	<a href="#">PE7044</a>	<a href="#">79</a>	
	25 W	<a href="#">PE7392</a>	<a href="#">72</a>	
	50 W	<a href="#">PE7394</a>	<a href="#">74</a>	
6 GHz	5 W	<a href="#">PE7AP006</a>	<a href="#">70</a>	
		100 W	<a href="#">PE7213</a>	<a href="#">77</a>
	150 W	<a href="#">PE7AP150</a>	<a href="#">78</a>	
TNC Female	6 GHz	100 W	<a href="#">PE7237</a>	<a href="#">77</a>
<b>QMA Male</b>				
QMA Female	6 GHz	1 W	<a href="#">PE7AP1002</a>	<a href="#">67</a>
<b>QN Male</b>				
QN Female	3 GHz	1 W	<a href="#">PE7AP1000</a>	<a href="#">67</a>
<b>SMA Female</b>				
SMA Female	1 GHz	0.5 W	<a href="#">PE70A8000</a>	<a href="#">81</a>
		1 W	<a href="#">PE70A8001</a>	<a href="#">81</a>

Connector In-Out	Max Freq.	Power	Model No.	Page
<b>SMA Female</b>				
SMA Female	1.5 GHz	1 W	<a href="#">PE70A8005</a>	<a href="#">81</a>
		0 W	<a href="#">PE70A2002</a>	<a href="#">82</a>
	12 GHz	0.16 W	<a href="#">PE70A4000</a>	<a href="#">82</a>
		0.32 W	<a href="#">PE70A5003</a>	<a href="#">81</a>
	13 GHz	0 W	<a href="#">PE70A2003</a>	<a href="#">82</a>
		0.1 W	<a href="#">PE70A3900</a>	<a href="#">82</a>
		1 W	<a href="#">PE70A6000</a>	<a href="#">82</a>
		20 W	<a href="#">PE70A2900</a>	<a href="#">82</a>
		25 W	<a href="#">PE7363</a>	<a href="#">73</a>
	18 GHz	50 W	<a href="#">PE7337</a>	<a href="#">75</a>
		0.5 W	<a href="#">PE70A8002</a>	<a href="#">81</a>
		2 W	<a href="#">PE70A1025</a>	<a href="#">80</a>
	2.2 GHz	2 W	<a href="#">PE70A1023</a>	<a href="#">80</a>
			<a href="#">PE70A1031</a>	<a href="#">82</a>
	20 GHz	18 W	<a href="#">PE70A1017</a>	<a href="#">82</a>
	3 GHz	0 W	<a href="#">PE70A5004</a>	<a href="#">82</a>
			<a href="#">PE70A5006</a>	<a href="#">82</a>
			<a href="#">PE70A5005</a>	<a href="#">82</a>
			<a href="#">PE70A5007</a>	<a href="#">82</a>
			<a href="#">PE70A5008</a>	<a href="#">82</a>
4 GHz	5 W	<a href="#">PE70A2000</a>	<a href="#">82</a>	
		<a href="#">PE7422</a>	<a href="#">81</a>	
6 GHz	0 W	<a href="#">PE70A5009</a>	<a href="#">82</a>	
		<a href="#">PE70A5013</a>	<a href="#">82</a>	
		<a href="#">PE70A5010</a>	<a href="#">82</a>	
		<a href="#">PE70A3902</a>	<a href="#">82</a>	
		<a href="#">PE70A1000</a>	<a href="#">82</a>	
8 GHz	0 W	<a href="#">PE70A5000</a>	<a href="#">82</a>	
		<a href="#">PE7228</a>	<a href="#">78</a>	
		<a href="#">PE70A2001</a>	<a href="#">82</a>	
SMA Male	6 GHz	100 W	<a href="#">PE7221</a>	<a href="#">77</a>
<b>SMA Male</b>				
SMA Female	1.5 GHz	100 W	<a href="#">PE7022</a>	<a href="#">77</a>
		12.4 GHz	<a href="#">PE7045</a>	<a href="#">69</a>
	18 GHz	2 W	<a href="#">PE7005</a>	<a href="#">69</a>
			<a href="#">PE7092</a>	<a href="#">69</a>
		5 W	<a href="#">PE7013</a>	<a href="#">71</a>
		10 W	<a href="#">PE7016</a>	<a href="#">72</a>
		25 W	<a href="#">PE7018</a>	<a href="#">73</a>
	50 W	<a href="#">PE7357</a>	<a href="#">73</a>	
		<a href="#">PE7020</a>	<a href="#">75</a>	
		<a href="#">PE7427</a>	<a href="#">75</a>	
	2 GHz	1 W	<a href="#">PE7161</a>	<a href="#">67</a>
	26 GHz	2 W	<a href="#">PE7061</a>	<a href="#">81</a>
			<a href="#">PE7087</a>	<a href="#">69</a>
	3 GHz	5 W	<a href="#">PE7001</a>	<a href="#">68</a>
	4 GHz	25 W	<a href="#">PE7391</a>	<a href="#">70</a>
			<a href="#">PE7393</a>	<a href="#">73</a>
	6 GHz	2 W	<a href="#">PE70A1009</a>	<a href="#">68</a>
			<a href="#">PE70A1010</a>	<a href="#">68</a>
			<a href="#">PE70A1011</a>	<a href="#">68</a>
			<a href="#">PE70A1012</a>	<a href="#">68</a>
<a href="#">PE70A1013</a>			<a href="#">68</a>	
<a href="#">PE70A1014</a>			<a href="#">68</a>	
<a href="#">PE70A1015</a>			<a href="#">68</a>	
<a href="#">PE7091</a>			<a href="#">68</a>	
<a href="#">PE7162</a>			<a href="#">69</a>	
10 W			<a href="#">PE7428</a>	<a href="#">72</a>
100 W			<a href="#">PE7227</a>	<a href="#">77</a>
<b>TNC Female</b>				
N Female	6 GHz	100 W	<a href="#">PE7218</a>	<a href="#">78</a>
N Male	6 GHz	100 W	<a href="#">PE7210</a>	<a href="#">78</a>
TNC Female	18 GHz	50 W	<a href="#">PE7351</a>	<a href="#">75</a>
<b>TNC Male</b>				
TNC Female	1.5 GHz	100 W	<a href="#">PE7056</a>	<a href="#">78</a>
		12.4 GHz	<a href="#">PE7051</a>	<a href="#">70</a>
	18 GHz	2 W	<a href="#">PE7030</a>	<a href="#">70</a>
			<a href="#">PE7052</a>	<a href="#">71</a>
		5 W	<a href="#">PE7053</a>	<a href="#">72</a>
		10 W	<a href="#">PE7054</a>	<a href="#">73</a>
		25 W	<a href="#">PE7375</a>	<a href="#">73</a>
		50 W	<a href="#">PE7055</a>	<a href="#">75</a>
		1 W	<a href="#">PE7003</a>	<a href="#">67</a>
		2 W	<a href="#">PE7063</a>	<a href="#">81</a>

Attenuators & Equalizers



Technical Support  
+1 (949) 261-1920



Same-Day Shipping,  
Even Custom Cable Assemblies

# PASSIVE ATTENUATORS

## Fixed Attenuators

50 Ohm



Attenuators & Equalizers

See Our Website For Current Pricing & Real-Time Stock Availability!

Max. Power (Watts)	Connector Input	Connector Output	Max. Freq.	Construction Material	VSWR Max.	Bi-Dir.*	ATTN. (dB)	Model No	1 Pc. Price	See Web for Volume Pricing	ROW
0.5 W	2.92mm Male	2.92mm Female	40 GHz	Passivated Stainless Steel	1.4:1		0	<a href="#">PE7AP412-00</a>	\$239.97	See Web for Volume Pricing	
							1	<a href="#">PE7AP412-01</a>	\$239.79		
							2	<a href="#">PE7AP412-02</a>	\$239.79		
							3	<a href="#">PE7AP412-03</a>	\$238.94		
						Yes	3	<a href="#">PE7046-3</a>	\$477.94		
						Yes	6	<a href="#">PE7046-6</a>	\$477.94		
						Yes	10	<a href="#">PE7046-10</a>	\$462.71		
						Yes	20	<a href="#">PE7046-20</a>	\$477.94		
						Yes	30	<a href="#">PE7046-30</a>	\$477.94		
							4	<a href="#">PE7AP412-04</a>	\$259.61		
						5	<a href="#">PE7AP412-05</a>	\$249.87			
						6	<a href="#">PE7AP412-06</a>	\$254.39			
						8	<a href="#">PE7AP412-08</a>	\$264.17			
						9	<a href="#">PE7AP412-09</a>	\$254.25			
						10	<a href="#">PE7AP412-10</a>	\$259.61			
						12	<a href="#">PE7AP412-12</a>	\$249.87			
						15	<a href="#">PE7AP412-15</a>	\$249.87			
						20	<a href="#">PE7AP412-20</a>	\$259.61			
						30	<a href="#">PE7AP412-30</a>	\$258.75			
					1 W	1.85mm Male	1.85mm Female	65 GHz	Passivated Stainless Steel		
	2	<a href="#">PE7403-2</a>	\$718.99								
	3-3	<a href="#">PE7403-3</a>	\$627.43								
	4	<a href="#">PE7403-4</a>	\$692.00								
	5	<a href="#">PE7403-5</a>	\$692.00								
	6-6	<a href="#">PE7403-6</a>	\$616.22								
	7	<a href="#">PE7403-7</a>	\$692.00								
	8	<a href="#">PE7403-8</a>	\$692.00								
	10-10	<a href="#">PE7403-10</a>	\$627.43								
	15-15	<a href="#">PE7403-15</a>	Call								
	20-20	<a href="#">PE7403-20</a>	\$627.71								
	30-30	<a href="#">PE7403-30</a>	\$648.50								
Yes	10	<a href="#">PE7089-10</a>	\$389.72								
Yes	12	<a href="#">PE7089-12</a>	\$389.72								
Yes	15	<a href="#">PE7089-15</a>	\$389.72								
Yes	20	<a href="#">PE7089-20</a>	\$389.53								
Yes	30	<a href="#">PE7089-30</a>	\$388.67								
Yes	0	<a href="#">PE7089-0</a>	\$375.09								
Yes	1	<a href="#">PE7089-1</a>	\$389.72								
Yes	2	<a href="#">PE7089-2</a>	\$389.72								
Yes	3	<a href="#">PE7089-3</a>	\$378.71								
Yes	4	<a href="#">PE7089-4</a>	\$375.09								
Yes	5	<a href="#">PE7089-5</a>	\$375.09								
Yes	6	<a href="#">PE7089-6</a>	\$384.12								
Yes	7	<a href="#">PE7089-7</a>	\$375.09								
Yes	8	<a href="#">PE7089-8</a>	\$389.72								
Yes	9	<a href="#">PE7089-9</a>	\$375.09								
Yes	0	<a href="#">PE7088-0</a>	\$333.97								
Yes	1	<a href="#">PE7088-1</a>	\$318.79								
Yes	2	<a href="#">PE7088-2</a>	\$318.79								
Yes	3	<a href="#">PE7088-3</a>	\$292.72								
Yes	4	<a href="#">PE7088-4</a>	\$333.97								
Yes	5	<a href="#">PE7088-5</a>	\$333.97								
Yes	6	<a href="#">PE7088-6</a>	\$292.52								
Yes	7	<a href="#">PE7088-7</a>	\$333.97								
Yes	8	<a href="#">PE7088-8</a>	\$333.97								
Yes	9	<a href="#">PE7088-9</a>	\$333.97								
Yes	10	<a href="#">PE7088-10</a>	\$303.78								
Yes	12	<a href="#">PE7088-12</a>	\$333.97								
Yes	15	<a href="#">PE7088-15</a>	\$318.79								
Yes	20	<a href="#">PE7088-20</a>	\$292.52								
Yes	30	<a href="#">PE7088-30</a>	\$318.79								
Yes	1	<a href="#">PE7000-1</a>	\$53.69								
Yes	2	<a href="#">PE7000-2</a>	\$53.69								
Yes	3	<a href="#">PE7000-3</a>	\$55.99								
Yes	6	<a href="#">PE7000-6</a>	\$54.54								
Yes	10	<a href="#">PE7000-10</a>	\$53.07								
Yes	20	<a href="#">PE7000-20</a>	\$53.07								
Yes	30	<a href="#">PE7000-30</a>	\$54.54								

\* Bi-Dir is Bi-Directional. If No then Attenuator is Directional. Maximum power applies to input connector only.

## Fixed Attenuators

50 Ohm



Max. Power (Watts)	Connector Input	Connector Output	Max. Freq.	Construction Material	VSWR Max.	Bi-Dir.*	ATTN. (dB)	Model No	1 Pc. Price	See Web for Volume Pricing	ROW
1 W	N Male	N Female	3 GHz	Nickel Plated Brass	1.2:1	Yes	1	<a href="#">PE7002-1</a>	\$96.76	See Web for Volume Pricing	8
						Yes	2	<a href="#">PE7002-2</a>	\$96.76		
						Yes	3	<a href="#">PE7002-3</a>	\$89.48		
						Yes	6	<a href="#">PE7002-6</a>	\$87.09		
						Yes	10	<a href="#">PE7002-10</a>	\$86.85		
						Yes	20	<a href="#">PE7002-20</a>	\$87.09		
						Yes	30	<a href="#">PE7002-30</a>	\$87.09		
	Yes	40	<a href="#">PE7002-40</a>	\$96.76							
	QMA Male	QMA Female	6 GHz	Tri-Metal Plated Brass	1.2:1		12	<a href="#">PE7AP1002-12</a>	\$90.32		
							15	<a href="#">PE7AP1002-15</a>	\$93.84		
							0	<a href="#">PE7AP1002-0</a>	\$93.84		
							20	<a href="#">PE7AP1002-20</a>	\$93.84		
							1	<a href="#">PE7AP1002-1</a>	\$90.32		
							2	<a href="#">PE7AP1002-2</a>	\$90.32		
							3	<a href="#">PE7AP1002-3</a>	\$90.32		
							6	<a href="#">PE7AP1002-6</a>	\$93.84		
							9	<a href="#">PE7AP1002-9</a>	\$93.84		
							0	<a href="#">PE7AP1000-0</a>	\$128.52		
	QN Male	QN Female	3 GHz	Tri-Metal Plated Brass	1.2:1		1	<a href="#">PE7AP1000-1</a>	\$128.52		
							2	<a href="#">PE7AP1000-2</a>	\$128.52		
							3	<a href="#">PE7AP1000-3</a>	\$128.52		
							6	<a href="#">PE7AP1000-6</a>	\$133.53		
							9	<a href="#">PE7AP1000-9</a>	\$133.53		
							12	<a href="#">PE7AP1000-12</a>	\$128.52		
							15	<a href="#">PE7AP1000-15</a>	\$128.52		
	SMA Male	SMA Female	2 GHz	Nickel Plated Brass	1.2:1	Yes	1	<a href="#">PE7161-1</a>	\$69.12		
						Yes	2	<a href="#">PE7161-2</a>	\$69.12		
						Yes	3	<a href="#">PE7161-3</a>	\$65.49		
Yes						4	<a href="#">PE7161-4</a>	\$69.12			
Yes						5	<a href="#">PE7161-5</a>	\$69.12			
Yes						6	<a href="#">PE7161-6</a>	\$63.07			
Passivated Stainless Steel				Yes		8	<a href="#">PE7161-8</a>	\$54.11			
				Yes		9	<a href="#">PE7161-9</a>	\$56.54			
				Yes		10	<a href="#">PE7161-10</a>	\$66.45			
				Yes		12	<a href="#">PE7161-12</a>	\$60.60			
				Yes		15	<a href="#">PE7161-15</a>	\$58.46			
				Yes		20	<a href="#">PE7161-20</a>	\$64.67			
				Yes		30	<a href="#">PE7161-30</a>	\$66.45			
Nickel Plated Brass	Yes	40	<a href="#">PE7161-40</a>	\$69.71							
	Yes	1	<a href="#">PE7003-1</a>	\$84.64							
	Yes	10	<a href="#">PE7003-10</a>	\$77.65							
	Yes	20	<a href="#">PE7003-20</a>	\$74.09							
TNC Male	TNC Female		Nickel Plated Brass		Yes	30	<a href="#">PE7003-30</a>	\$79.78			
					Yes	40	<a href="#">PE7003-40</a>	\$84.64			
2 W	2.92mm Male	2.92mm Female	Passivated Stainless Steel	1.4:1	Yes	1	<a href="#">PE7024-1</a>	\$314.18			
					Yes	2	<a href="#">PE7024-2</a>	\$314.18			
					Yes	3	<a href="#">PE7024-3</a>	\$304.96			
					Yes	6	<a href="#">PE7024-6</a>	\$304.96			
					Yes	10	<a href="#">PE7024-10</a>	\$297.52			
					Yes	20	<a href="#">PE7024-20</a>	\$304.96			
					Yes	30	<a href="#">PE7024-30</a>	\$299.00			
			Stainless Steel		Yes	30	<a href="#">PE7024/SP-30</a>	\$205.33			
					Yes	3	<a href="#">PE7090-3</a>	\$440.42			
					Yes	6	<a href="#">PE7090-6</a>	\$440.42			
					Yes	10	<a href="#">PE7090-10</a>	\$411.06			
					Yes	15	<a href="#">PE7090-15</a>	\$440.42			
					Yes	20	<a href="#">PE7090-20</a>	\$411.06			
					Yes	30	<a href="#">PE7090-30</a>	\$397.31			
	Passivated Stainless Steel	0-0	<a href="#">PE7395-0</a>	\$189.46							
		1-1	<a href="#">PE7395-1</a>	\$194.66							
		2-2	<a href="#">PE7395-2</a>	\$194.66							
		3-3	<a href="#">PE7395-3</a>	\$189.43							
		4-4	<a href="#">PE7395-4</a>	\$188.38							
		5-5	<a href="#">PE7395-5</a>	\$188.38							
		6-6	<a href="#">PE7395-6</a>	\$189.24							
		7-7	<a href="#">PE7395-7</a>	\$222.65							
8-8		<a href="#">PE7395-8</a>	\$222.65								
9-9	<a href="#">PE7395-9</a>	\$188.38									

\* Bi-Dir is Bi-Directional. If No then Attenuator is Directional. Maximum power applies to input connector only.



Technical Support  
+1 (949) 261-1920



Same-Day Shipping,  
Even Custom Cable Assemblies

Attenuators & Equalizers

See Our Website For Current Pricing & Real-Time Stock Availability!

## Fixed Attenuators

50 Ohm



Max. Power (Watts)	Connector Input	Connector Output	Max. Freq.	Construction Material	VSWR Max.	Bi-Dir.*	ATTN. (dB)	Model No	1 Pc. Price	See Web for Volume Pricing	ROW	
2 W	2.92mm Male	2.92mm Female	40 GHz	Passivated Stainless Steel	1.6:1		10-10	<a href="#">PE7395-10</a>	\$189.43	See Web for Volume Pricing	16	
							12-12	<a href="#">PE7395-12</a>	\$200.42			
							15-15	<a href="#">PE7395-15</a>	\$191.63			
							20-20	<a href="#">PE7395-20</a>	\$194.66			
	BNC Male	BNC Female	4 GHz	Nickel Plated Brass	1.25:1	Yes	1	<a href="#">PE7049-1</a>	\$119.18			
						Yes	2	<a href="#">PE7049-2</a>	\$119.18			
						Yes	3	<a href="#">PE7049-3</a>	\$113.25			
						Yes	6	<a href="#">PE7049-6</a>	\$113.25			
						Yes	10	<a href="#">PE7049-10</a>	\$123.16			
						Yes	20	<a href="#">PE7049-20</a>	\$113.25			
	N Male	N Female	18 GHz	Passivated Stainless Steel	1.35:1		Yes	1	<a href="#">PE7004-1</a>			\$223.98
							Yes	2	<a href="#">PE7004-2</a>			\$223.04
							Yes	3	<a href="#">PE7004-3</a>			\$208.49
							Yes	4	<a href="#">PE7004-4</a>			\$223.04
							Yes	5	<a href="#">PE7004-5</a>			\$223.98
							Yes	6	<a href="#">PE7004-6</a>			\$208.29
						Yes	7	<a href="#">PE7004-7</a>	\$223.98			
						Yes	8	<a href="#">PE7004-8</a>	\$180.51			
						Yes	9	<a href="#">PE7004-9</a>	\$196.76			
						Yes	10	<a href="#">PE7004-10</a>	\$202.65			
						Yes	12	<a href="#">PE7004-12</a>	\$211.24			
						Yes	15	<a href="#">PE7004-15</a>	\$216.43			
						Yes	20	<a href="#">PE7004-20</a>	\$208.49			
						Yes	30	<a href="#">PE7004-30</a>	\$208.29			
						Yes	40	<a href="#">PE7004-40</a>	\$223.04			
						Yes	2	<a href="#">PE7047-2</a>	\$175.84			
						Yes	3	<a href="#">PE7047-3</a>	\$164.98			
						Yes	4	<a href="#">PE7047-4</a>	\$175.84			
						Yes	5	<a href="#">PE7047-5</a>	\$175.84			
						Yes	6	<a href="#">PE7047-6</a>	\$164.04			
	Yes	7	<a href="#">PE7047-7</a>	\$161.32								
	Yes	8	<a href="#">PE7047-8</a>	\$140.17								
	Yes	9	<a href="#">PE7047-9</a>	\$156.99								
	Yes	10	<a href="#">PE7047-10</a>	\$169.52								
	Yes	12	<a href="#">PE7047-12</a>	\$168.56								
	Yes	15	<a href="#">PE7047-15</a>	\$180.59								
	Yes	20	<a href="#">PE7047-20</a>	\$164.98								
	Yes	30	<a href="#">PE7047-30</a>	\$164.98								
	Yes	40	<a href="#">PE7047-40</a>	\$175.84								
SMA Male	SMA Female	6 GHz	Copper	1.22:1	1.07:1	3	<a href="#">PE70A1009</a>	\$142.91				
					1.15:1	3	<a href="#">PE70A1010</a>	\$56.30				
					1.07:1	6	<a href="#">PE70A1011</a>	\$151.25				
					1.15:1	6	<a href="#">PE70A1012</a>	\$56.30				
					9	<a href="#">PE70A1013</a>	\$56.30					
					12	<a href="#">PE70A1014</a>	\$56.30					
					16	<a href="#">PE70A1015</a>	\$61.30					
					18	<a href="#">PE70A1016</a>	\$56.30					
		3 GHz	Passivated Stainless Steel	1.2:1	Yes	1	<a href="#">PE7001-1</a>	\$94.17				
					Yes	2	<a href="#">PE7001-2</a>	\$94.17				
					Yes	3	<a href="#">PE7001-3</a>	\$84.04				
					Yes	4	<a href="#">PE7001-4</a>	\$92.45				
					Yes	5	<a href="#">PE7001-5</a>	\$96.76				
					Yes	6	<a href="#">PE7001-6</a>	\$88.73				
6 GHz	Passivated Stainless Steel	1.35:1	Yes	7	<a href="#">PE7001-7</a>	\$96.76						
			Yes	8	<a href="#">PE7001-8</a>	\$79.22						
			Yes	9	<a href="#">PE7001-9</a>	\$88.73						
			Yes	10	<a href="#">PE7001-10</a>	\$87.30						
			Yes	12	<a href="#">PE7001-12</a>	\$88.73						
			Yes	15	<a href="#">PE7001-15</a>	\$88.73						
			Yes	20	<a href="#">PE7001-20</a>	\$87.30						
			Yes	30	<a href="#">PE7001-30</a>	\$88.73						
	Yes	40	<a href="#">PE7001-40</a>	\$96.76								
	Yes	0	<a href="#">PE7091-0</a>	\$39.84								
	Yes	1	<a href="#">PE7091-1</a>	\$43.09								
	Yes	2	<a href="#">PE7091-2</a>	\$47.64								
	Yes	3	<a href="#">PE7091-3</a>	\$39.84								
	Yes	4	<a href="#">PE7091-4</a>	\$47.64								
	Yes	5	<a href="#">PE7091-5</a>	\$48.50								
	Yes	6	<a href="#">PE7091-6</a>	\$43.09								

\* Bi-Dir is Bi-Directional. If No then Attenuator is Directional. Maximum power applies to input connector only.

Attenuators & Equalizers

See Our Website For Current Pricing & Real-Time Stock Availability!



## Fixed Attenuators

50 Ohm



Max. Power (Watts)	Connector Input	Connector Output	Max. Freq.	Construction Material	VSWR Max.	Bi-Dir.*	ATTN. (dB)	Model No	1 Pc. Price	See Web for Volume Pricing	ROW
2 W	SMA Male	SMA Female	6 GHz	Passivated Stainless Steel	1.35:1	Yes	7	<a href="#">PE7091-7</a>	\$47.64	See Web for Volume Pricing	29
						Yes	10	<a href="#">PE7091-10</a>	\$43.27		
						Yes	12	<a href="#">PE7091-12</a>	\$42.22		
						Yes	15	<a href="#">PE7091-15</a>	\$42.22		
						Yes	20	<a href="#">PE7091-20</a>	\$41.67		
						Yes	30	<a href="#">PE7091-30</a>	\$43.30		
						Yes	40	<a href="#">PE7091-40</a>	\$54.33		
						Yes	1	<a href="#">PE7162-1</a>	\$51.15		
						Yes	2	<a href="#">PE7162-2</a>	\$50.08		
						Yes	3	<a href="#">PE7162-3</a>	\$36.62		
						Yes	4	<a href="#">PE7162-4</a>	\$48.73		
						Yes	5	<a href="#">PE7162-5</a>	\$49.80		
						Yes	6	<a href="#">PE7162-6</a>	\$31.16		
						Yes	7	<a href="#">PE7162-7</a>	\$46.02		
						Yes	8	<a href="#">PE7162-8</a>	\$46.02		
						Yes	9	<a href="#">PE7162-9</a>	\$44.67		
						Yes	10	<a href="#">PE7162-10</a>	\$39.97		
						Yes	12	<a href="#">PE7162-12</a>	\$44.67		
						Yes	15	<a href="#">PE7162-15</a>	\$44.67		
						Yes	20	<a href="#">PE7162-20</a>	\$36.84		
			Yes		30	<a href="#">PE7162-30</a>	\$43.91				
			Yes		40	<a href="#">PE7162-40</a>	\$51.15				
			Yes		1	<a href="#">PE7045-1</a>	\$132.17				
			Yes		2	<a href="#">PE7045-2</a>	\$128.64				
			Yes		3	<a href="#">PE7045-3</a>	\$116.84				
			Yes		4	<a href="#">PE7045-4</a>	\$118.01				
			Yes		5	<a href="#">PE7045-5</a>	\$132.17				
			Yes		6	<a href="#">PE7045-6</a>	\$120.05				
			Yes		7	<a href="#">PE7045-7</a>	\$110.92				
			Yes		8	<a href="#">PE7045-8</a>	\$99.04				
			Yes		9	<a href="#">PE7045-9</a>	\$110.92				
			Yes		10	<a href="#">PE7045-10</a>	\$115.61				
			Yes		12	<a href="#">PE7045-12</a>	\$110.92				
			Yes		15	<a href="#">PE7045-15</a>	\$120.05				
			Yes		20	<a href="#">PE7045-20</a>	\$120.05				
			Yes		30	<a href="#">PE7045-30</a>	\$120.05				
			Yes		40	<a href="#">PE7045-40</a>	\$132.17				
			Yes		1	<a href="#">PE7005-1</a>	\$69.28				
			Yes		2	<a href="#">PE7005-2</a>	\$64.67				
			Yes		3	<a href="#">PE7005-3</a>	\$63.04				
Yes	4	<a href="#">PE7005-4</a>	\$77.28								
Yes	5	<a href="#">PE7005-5</a>	\$70.57								
Yes	6	<a href="#">PE7005-6</a>	\$66.72								
Yes	7	<a href="#">PE7005-7</a>	\$76.66								
Yes	8	<a href="#">PE7005-8</a>	\$76.66								
Yes	9	<a href="#">PE7005-9</a>	\$72.73								
Yes	10	<a href="#">PE7005-10</a>	\$63.04								
Yes	12	<a href="#">PE7005-12</a>	\$72.73								
Yes	15	<a href="#">PE7005-15</a>	\$67.35								
Yes	20	<a href="#">PE7005-20</a>	\$65.72								
Yes	30	<a href="#">PE7005-30</a>	\$63.98								
Yes	40	<a href="#">PE7005-40</a>	\$74.57								
Yes	1	<a href="#">PE7092-1</a>	\$48.50								
Yes	2	<a href="#">PE7092-2</a>	\$48.50								
Yes	3	<a href="#">PE7092-3</a>	\$43.27								
Yes	4	<a href="#">PE7092-4</a>	\$49.81								
Yes	5	<a href="#">PE7092-5</a>	\$49.58								
Yes	6	<a href="#">PE7092-6</a>	\$43.27								
Yes	7	<a href="#">PE7092-7</a>	\$48.72								
Yes	8	<a href="#">PE7092-8</a>	\$48.72								
Yes	9	<a href="#">PE7092-9</a>	\$42.22								
Yes	10	<a href="#">PE7092-10</a>	\$43.27								
Yes	12	<a href="#">PE7092-12</a>	\$42.22								
Yes	15	<a href="#">PE7092-15</a>	\$43.09								
Yes	20	<a href="#">PE7092-20</a>	\$43.27								
Yes	30	<a href="#">PE7092-30</a>	\$43.09								
Yes	40	<a href="#">PE7092-40</a>	\$63.33								
Yes	0	<a href="#">PE7087-0</a>	\$103.68								
Yes	1	<a href="#">PE7087-1</a>	\$116.67								
			26 GHz		1.4:1						34

Attenuators & Equalizers

See Our Website For Current Pricing & Real-Time Stock Availability!

\* Bi-Dir is Bi-Directional. If No then Attenuator is Directional. Maximum power applies to input connector only.

## Fixed Attenuators

50 Ohm



Max. Power (Watts)	Connector Input	Connector Output	Max. Freq.	Construction Material	VSWR Max.	Bi-Dir.*	ATTN. (dB)	Model No	1 Pc. Price	See Web for Volume Pricing	ROW										
2 W	SMA Male	SMA Female	26 GHz	Passivated Stainless Steel	1.4:1	Yes	2	<a href="#">PE7087-2</a>	\$116.67		34										
						Yes	3	<a href="#">PE7087-3</a>	\$97.53												
						Yes	4	<a href="#">PE7087-4</a>	\$115.63												
						Yes	5	<a href="#">PE7087-5</a>	\$115.63												
						Yes	6	<a href="#">PE7087-6</a>	\$102.18												
						Yes	7	<a href="#">PE7087-7</a>	\$115.63												
						Yes	8	<a href="#">PE7087-8</a>	\$115.63												
						Yes	9	<a href="#">PE7087-9</a>	\$109.14												
						Yes	10	<a href="#">PE7087-10</a>	\$102.18												
						Yes	12	<a href="#">PE7087-12</a>	\$110.44												
						Yes	15	<a href="#">PE7087-15</a>	\$116.67												
						Yes	20	<a href="#">PE7087-20</a>	\$102.18												
						Yes	30	<a href="#">PE7087-30</a>	\$102.18												
						Yes	2	<a href="#">PE7003-2</a>	\$74.70												
						2 W	TNC Male	TNC Female	2 GHz			Nickel Plated Brass	1.15:1	Yes	3	<a href="#">PE7003-3</a>	\$71.23	See Web for Volume Pricing	35		
Yes	6	<a href="#">PE7003-6</a>	\$79.78																		
Yes	1	<a href="#">PE7051-1</a>	\$175.84																		
Yes	2	<a href="#">PE7051-2</a>	\$175.84																		
Yes	3	<a href="#">PE7051-3</a>	\$156.51																		
Yes	6	<a href="#">PE7051-6</a>	\$161.02																		
2 W	TNC Male	TNC Female	12.4 GHz	Nickel Plated Brass	1.25:1				Yes	10	<a href="#">PE7051-10</a>	\$161.95	36								
									Yes	20	<a href="#">PE7051-20</a>	\$179.50									
									Yes	30	<a href="#">PE7051-30</a>	\$174.19									
									Yes	40	<a href="#">PE7051-40</a>	\$161.32									
									Yes	1	<a href="#">PE7030-1</a>	\$254.69									
									Yes	2	<a href="#">PE7030-2</a>	\$291.23									
			2 W	TNC Male	TNC Female				18 GHz	Passivated Stainless Steel	1.35:1	Yes		3	<a href="#">PE7030-3</a>	\$302.60	37				
												Yes		6	<a href="#">PE7030-6</a>	\$302.60					
												Yes		10	<a href="#">PE7030-10</a>	\$302.60					
						Yes	20	<a href="#">PE7030-20</a>				\$305.64									
						Yes	30	<a href="#">PE7030-30</a>				\$277.62									
						Yes	1	<a href="#">PE7039-1</a>				\$243.44									
						5 W	7/16 DIN Male	7/16 DIN Female	7.5 GHz	Tri-Metal Plated Brass	1.25:1	Yes		2	<a href="#">PE7039-2</a>	\$204.29		38			
												Yes		3	<a href="#">PE7039-3</a>	\$212.26					
												Yes		6	<a href="#">PE7039-6</a>	\$212.26					
Yes	10	<a href="#">PE7039-10</a>										\$231.36									
Yes	20	<a href="#">PE7039-20</a>										\$212.26									
5 W	N Male	N Female										3 GHz	Aluminum	1.2:1	Yes	30			<a href="#">PE7039-30</a>	\$275.70	39
															Yes	1			<a href="#">PE7390-1</a>	\$69.29	
															Yes	2			<a href="#">PE7390-2</a>	\$69.29	
															Yes	3			<a href="#">PE7390-3</a>	\$64.74	
			Yes	6	<a href="#">PE7390-6</a>										\$64.74						
			Yes	10	<a href="#">PE7390-10</a>										\$64.93						
			5 W	N Male	N Female							6 GHz	Black Anodized Aluminum Heatsink	1.25:1	Yes	15	<a href="#">PE7390-15</a>		\$63.88	40	
															Yes	20	<a href="#">PE7390-20</a>		\$64.74		
															Yes	30	<a href="#">PE7390-30</a>		\$64.74		
																1	<a href="#">PE7AP006-01</a>		\$108.37		
							2	<a href="#">PE7AP006-02</a>	\$112.60												
							3	<a href="#">PE7AP006-03</a>	\$107.18												
						5 W	N Male	N Female	6 GHz	Black Anodized Aluminum Heatsink	1.25:1		4	<a href="#">PE7AP006-04</a>	\$112.60	41					
													5	<a href="#">PE7AP006-05</a>	\$112.60						
													6	<a href="#">PE7AP006-06</a>	\$107.18						
	9	<a href="#">PE7AP006-09</a>										\$103.99									
	10	<a href="#">PE7AP006-10</a>										\$108.05									
	12	<a href="#">PE7AP006-12</a>										\$103.99									
5 W	N Male	N Female							6 GHz	Black Anodized Aluminum Heatsink	1.25:1		15	<a href="#">PE7AP006-15</a>	\$96.63		42				
													20	<a href="#">PE7AP006-20</a>	\$134.03						
													30	<a href="#">PE7AP006-30</a>	\$108.05						
				40	<a href="#">PE7AP006-40</a>							\$118.87									
			Yes	1	<a href="#">PE7014-1</a>							\$302.06									
			Yes	2	<a href="#">PE7014-2</a>							\$302.06									
			5 W	SMA Male	SMA Female				3 GHz		1.2:1	Yes	3	<a href="#">PE7014-3</a>	\$317.45			41			
												Yes	6	<a href="#">PE7014-6</a>	\$317.45						
												Yes	10	<a href="#">PE7014-10</a>	\$311.63						
						Yes	20	<a href="#">PE7014-20</a>				\$317.45									
						Yes	30	<a href="#">PE7014-30</a>				\$311.63									
						5 W	SMA Male	SMA Female				3 GHz		1.2:1	Yes	40			<a href="#">PE7014-40</a>	\$329.25	42
															Yes	1			<a href="#">PE7391-1</a>	\$67.13	
															Yes	2			<a href="#">PE7391-2</a>	\$69.29	

\* Bi-Dir is Bi-Directional. If No then Attenuator is Directional. Maximum power applies to input connector only.

Attenuators & Equalizers

See Our Website For Current Pricing & Real-Time Stock Availability!

## Fixed Attenuators

50 Ohm



Max. Power (Watts)	Connector Input	Connector Output	Max. Freq.	Construction Material	VSWR Max.	Bi-Dir.*	ATTN. (dB)	Model No	1 Pc. Price	See Web for Volume Pricing	ROW	
5 W	SMA Male	SMA Female	3 GHz	Black Anodized Aluminum Heatsink	1.2:1	Yes	3	<a href="#">PE7391-3</a>	\$63.88	See Web for Volume Pricing	42	
				Aluminum		Yes	6	<a href="#">PE7391-6</a>	\$63.88			
				Black Anodized Aluminum Heatsink		Yes	10	<a href="#">PE7391-10</a>	\$63.88			
				Aluminum		Yes	15	<a href="#">PE7391-15</a>	\$63.88			
			TNC Male	TNC Female	18 GHz	Black Anodized Aluminum Heatsink	1.35:1	Yes	20		<a href="#">PE7391-20</a>	\$64.74
								Yes	30		<a href="#">PE7391-30</a>	\$64.74
	Yes	1						<a href="#">PE7013-1</a>	\$179.03			
	Yes	2						<a href="#">PE7013-2</a>	\$187.64			
	Yes	3						<a href="#">PE7013-3</a>	\$168.67			
	Yes	6						<a href="#">PE7013-6</a>	\$173.18			
	Yes	10						<a href="#">PE7013-10</a>	\$168.87			
	Yes	20						<a href="#">PE7013-20</a>	\$173.53			
	Yes	30						<a href="#">PE7013-30</a>	\$168.67			
	Yes	40						<a href="#">PE7013-40</a>	\$188.58			
	Yes	1						<a href="#">PE7052-1</a>	\$312.95			
	Yes	2						<a href="#">PE7052-2</a>	\$312.95			
	Yes	3	<a href="#">PE7052-3</a>	\$312.95								
	Yes	6	<a href="#">PE7052-6</a>	\$312.95								
Yes	10	<a href="#">PE7052-10</a>	\$312.95									
Yes	20	<a href="#">PE7052-20</a>	\$312.95									
Yes	30	<a href="#">PE7052-30</a>	\$312.88									
10 W	2.92mm Male	2.92mm Female	40 GHz		1.5:1	No	10	<a href="#">PE7AP402-10</a>	\$984.98	See Web for Volume Pricing	45	
						No	20	<a href="#">PE7AP402-20</a>	\$984.98			
						Yes	3	<a href="#">PE7AP402-3</a>	\$983.42			
						Yes	6	<a href="#">PE7AP402-6</a>	\$968.88			
						No	30	<a href="#">PE7AP402-30</a>	\$984.98			
						Yes	6	<a href="#">PE7040-6</a>	\$301.97			
	7/16 DIN Male	7/16 DIN Female	7.5 GHz		1.45:1	Yes	10	<a href="#">PE7040-10</a>	\$348.81			
						Yes	20	<a href="#">PE7040-20</a>	\$198.27			
						Yes	30	<a href="#">PE7040-30</a>	\$214.26			
						Yes	2	<a href="#">PE7025-2</a>	\$323.71			
						Yes	3	<a href="#">PE7025-3</a>	\$341.05			
						Yes	6	<a href="#">PE7025-6</a>	\$325.40			
	BNC Male	BNC Female	2 GHz		1.6:1	Yes	10	<a href="#">PE7025-10</a>	\$334.79			
						Yes	20	<a href="#">PE7025-20</a>	\$334.79			
						Yes	30	<a href="#">PE7025-30</a>	\$319.13			
						Yes	40	<a href="#">PE7025-40</a>	\$352.85			
						Yes	2	<a href="#">PE7010-2</a>	\$237.10			
						Yes	3	<a href="#">PE7010-3</a>	\$247.58			
	N Male	N Female	3 GHz		1.2:1	Yes	6	<a href="#">PE7010-6</a>	\$247.58			
						Yes	10	<a href="#">PE7010-10</a>	\$247.58			
						Yes	20	<a href="#">PE7010-20</a>	\$247.58			
						Yes	30	<a href="#">PE7010-30</a>	\$246.65			
						Yes	40	<a href="#">PE7010-40</a>	\$206.20			
						Yes	3	<a href="#">PE7386-3</a>	\$150.49			
						Yes	6	<a href="#">PE7386-6</a>	\$150.49			
						Yes	10	<a href="#">PE7386-10</a>	\$150.49			
						Yes	15	<a href="#">PE7386-15</a>	\$123.74			
						Yes	20	<a href="#">PE7386-20</a>	\$150.49			
						Yes	30	<a href="#">PE7386-30</a>	\$150.49			
						Yes	40	<a href="#">PE7386-40</a>	\$161.32			
12.4 GHz				1.35:1	Yes	1	<a href="#">PE7048-1</a>	\$392.71				
					Yes	2	<a href="#">PE7048-2</a>	\$392.71				
					Yes	3	<a href="#">PE7048-3</a>	\$388.25				
					Yes	6	<a href="#">PE7048-6</a>	\$386.75				
					Yes	10	<a href="#">PE7048-10</a>	\$381.13				
					Yes	20	<a href="#">PE7048-20</a>	\$381.70				
					Yes	30	<a href="#">PE7048-30</a>	\$371.34				
					Yes	40	<a href="#">PE7048-40</a>	\$381.70				
					18 GHz		1.4:1	Yes	1	<a href="#">PE7015-1</a>	\$302.04	
								Yes	2	<a href="#">PE7015-2</a>	\$311.19	
								Yes	3	<a href="#">PE7015-3</a>	\$381.70	
								Yes	6	<a href="#">PE7015-6</a>	\$382.60	
Yes	10	<a href="#">PE7015-10</a>	\$381.70									
Yes	20	<a href="#">PE7015-20</a>	\$375.25									

Attenuators & Equalizers

See Our Website For Current Pricing & Real-Time Stock Availability!

\* Bi-Dir is Bi-Directional. If No then Attenuator is Directional. Maximum power applies to input connector only.



Technical Support  
+1 (949) 261-1920



Same-Day Shipping,  
Even Custom Cable Assemblies

## Fixed Attenuators

50 Ohm



Max. Power (Watts)	Connector Input	Connector Output	Max. Freq.	Construction Material	VSWR Max.	Bi-Dir.*	ATTN. (dB)	Model No	1 Pc. Price	See Web for Volume Pricing	ROW							
10 W	N Male	N Female	18 GHz	Black Anodized Aluminum Heatsink	1.4:1	Yes	30	<a href="#">PE7015-30</a>	\$382.60	See Web for Volume Pricing	51							
			6 GHz		1.2:1	Yes	40	<a href="#">PE7015-40</a>	\$392.96		52							
	SMA Male	SMA Female	18 GHz		1.4:1	Yes	10	<a href="#">PE7428-10</a>	\$163.51		53							
					Yes	1	<a href="#">PE7016-1</a>	\$381.13										
					Yes	2	<a href="#">PE7016-2</a>	\$348.30										
					Yes	3	<a href="#">PE7016-3</a>	\$360.08										
					Yes	6	<a href="#">PE7016-6</a>	\$353.16										
					Yes	10	<a href="#">PE7016-10</a>	\$351.62										
					Yes	20	<a href="#">PE7016-20</a>	\$353.34										
					Yes	30	<a href="#">PE7016-30</a>	\$360.08										
	TNC Male	TNC Female	18 GHz		1.4:1	Yes	40	<a href="#">PE7016-40</a>	\$381.70									
					Yes	1	<a href="#">PE7053-1</a>	\$408.65										
					Yes	2	<a href="#">PE7053-2</a>	\$408.65										
					Yes	3	<a href="#">PE7053-3</a>	\$465.19										
Yes				6	<a href="#">PE7053-6</a>	\$436.86	54											
Yes				10	<a href="#">PE7053-10</a>	\$465.19												
15 W	4.3-10 Male	4.3-10 Female	6 GHz	Aluminum	1.15:1		10	<a href="#">PE7AP1001-10</a>	\$295.93	See Web for Volume Pricing	55							
							3	<a href="#">PE7AP1001-3</a>	\$295.93									
							6	<a href="#">PE7AP1001-6</a>	\$295.93									
							20	<a href="#">PE7AP1001-20</a>	\$295.93									
							50	<a href="#">PE7379-50</a>	\$455.66									
25 W	7/16 DIN Male	7/16 DIN Female	6 GHz	Black Anodized Aluminum Heatsink	1.3:1	Yes	3	<a href="#">PE7041-3</a>	\$476.79	See Web for Volume Pricing	56							
							6	<a href="#">PE7041-6</a>	\$476.79									
							10	<a href="#">PE7041-10</a>	\$594.47			57						
							20	<a href="#">PE7041-20</a>	\$412.49									
							30	<a href="#">PE7041-30</a>	\$476.79									
							10	<a href="#">PE7379-10</a>	\$595.95									
			20				<a href="#">PE7379-20</a>	\$477.98										
			30				<a href="#">PE7379-30</a>	\$455.66										
			7/16 DIN Female				7/16 DIN Female	7.5 GHz	1.45:1		1.3:1	Yes	40	<a href="#">PE7379-40</a>	\$455.66	58		
													3	<a href="#">PE7379-3</a>	\$455.66			
													6	<a href="#">PE7379-6</a>	\$455.66			
													50	<a href="#">PE7380-50</a>	\$462.25			
	3	<a href="#">PE7380-3</a>			\$462.25													
	6	<a href="#">PE7380-6</a>			\$462.25													
	N Male	N Female	6 GHz		1.45:1	1.45:1	Yes	10	<a href="#">PE7380-10</a>		\$462.25	59						
								20	<a href="#">PE7380-20</a>		\$462.25							
								30	<a href="#">PE7380-30</a>		\$462.25							
								40	<a href="#">PE7380-40</a>		\$462.25							
								50	<a href="#">PE7366-50</a>		\$403.39							
								10	<a href="#">PE7366-10</a>		\$403.39							
			7.5 GHz		N Female	7.5 GHz	1.45:1	1.45:1	Yes		20	<a href="#">PE7366-20</a>	\$403.39	60				
											30	<a href="#">PE7366-30</a>	\$419.12					
											40	<a href="#">PE7366-40</a>	\$419.12					
											3	<a href="#">PE7366-3</a>	\$403.39					
6				<a href="#">PE7366-6</a>						\$403.39								
1				<a href="#">PE7392-1</a>						\$215.45								
N Male	N Female	4 GHz	1.25:1	1.25:1	Yes	2	<a href="#">PE7392-2</a>	\$215.45	61									
						3	<a href="#">PE7392-3</a>	\$202.01										
						6	<a href="#">PE7392-6</a>	\$204.62										
						10	<a href="#">PE7392-10</a>	\$204.62										
						20	<a href="#">PE7392-20</a>	\$205.48										
						30	<a href="#">PE7392-30</a>	\$205.48										
		8 GHz	N Female	8 GHz	1.6:1	1.6:1	Yes	40	<a href="#">PE7392-40</a>	\$215.45	62							
								50	<a href="#">PE7367-50</a>	\$464.45								
								18 GHz	N Female	18 GHz		1.4:1	1.4:1	Yes	1	<a href="#">PE7017-1</a>	\$558.98	63
															2	<a href="#">PE7017-2</a>	\$635.21	
															3	<a href="#">PE7017-3</a>	\$558.98	
															6	<a href="#">PE7017-6</a>	\$554.84	
10	<a href="#">PE7017-10</a>	\$558.98																
20	<a href="#">PE7017-20</a>	\$558.98																
25 W	N Male	N Female	18 GHz	1.45:1	Yes	30	<a href="#">PE7017-30</a>	\$558.98	64									
						40	<a href="#">PE7017-40</a>	\$648.29										
						10	<a href="#">PE7367-10</a>	\$460.00										
						20	<a href="#">PE7367-20</a>	\$460.00										
25 W	N Male	N Female	18 GHz	1.6:1	Yes	30	<a href="#">PE7367-30</a>	\$448.78	64									
						40	<a href="#">PE7367-40</a>	\$464.45										

\* Bi-Dir is Bi-Directional. If No then Attenuator is Directional. Maximum power applies to input connector only.

Attenuators & Equalizers

See Our Website For Current Pricing & Real-Time Stock Availability!

## Fixed Attenuators

50 Ohm



Max. Power (Watts)	Connector Input	Connector Output	Max. Freq.	Construction Material	VSWR Max.	Bi-Dir.*	ATTN. (dB)	Model No	1 Pc. Price	See Web for Volume Pricing	ROW	
<b>25 W</b>	N Male	N Female	18 GHz	Black Anodized Aluminum Heatsink	1.6:1	Yes	3	<a href="#">PE7367-3</a>	\$460.00	See Web for Volume Pricing	64	
			6 GHz		1.3:1	Yes	6	<a href="#">PE7367-6</a>	\$460.00		65	
	7.5 GHz	7/16 DIN Male	1.45:1		Yes	50	<a href="#">PE7370-50</a>	\$395.41	65			
			Yes		3	<a href="#">PE7370-3</a>	\$395.41	65				
			Yes		6	<a href="#">PE7370-6</a>	\$395.41	65				
			Yes		10	<a href="#">PE7370-10</a>	\$395.41	65				
			Yes		20	<a href="#">PE7370-20</a>	\$395.41	65				
			Yes		30	<a href="#">PE7370-30</a>	\$395.41	65				
	7.5 GHz	7/16 DIN Female	1.3:1		Yes	50	<a href="#">PE7369-50</a>	\$402.00	66			
			1.45:1		Yes	10	<a href="#">PE7369-10</a>	\$402.00	66			
			Yes		20	<a href="#">PE7369-20</a>	\$402.00	66				
			Yes		30	<a href="#">PE7369-30</a>	\$402.00	66				
			Yes		40	<a href="#">PE7369-40</a>	\$402.00	66				
			Yes		3	<a href="#">PE7369-3</a>	\$402.00	66				
	18 GHz	N Female	1.6:1		Yes	50	<a href="#">PE7371-50</a>	\$372.53	67			
			1.45:1		Yes	10	<a href="#">PE7371-10</a>	\$436.83	67			
			Yes		3	<a href="#">PE7371-3</a>	\$436.83	67				
			Yes		6	<a href="#">PE7371-6</a>	\$436.83	67				
			Yes		20	<a href="#">PE7371-20</a>	\$436.31	67				
			Yes		30	<a href="#">PE7371-30</a>	\$436.31	67				
	18 GHz	TNC Female	1.6:1		Yes	40	<a href="#">PE7371-40</a>	\$453.63	68			
			Yes		30	<a href="#">PE7372-30</a>	\$386.01	68				
			4 GHz		SMA Male	1.25:1	Yes	3	<a href="#">PE7393-3</a>		\$159.07	69
						Yes	10	<a href="#">PE7393-10</a>	\$195.66		69	
						Yes	20	<a href="#">PE7393-20</a>	\$195.66		69	
						Yes	30	<a href="#">PE7393-30</a>	\$195.66		69	
	Yes	40				<a href="#">PE7393-40</a>	\$215.45	69				
	Yes	50				<a href="#">PE7357-50</a>	\$343.45	70				
	18 GHz	SMA Female	1.4:1		Yes	1	<a href="#">PE7018-1</a>	\$540.24	71			
			Yes		2	<a href="#">PE7018-2</a>	\$540.24	71				
			Yes		3	<a href="#">PE7018-3</a>	\$616.32	71				
			Yes		6	<a href="#">PE7018-6</a>	\$616.32	71				
			Yes		10	<a href="#">PE7018-10</a>	\$616.32	71				
			Yes		20	<a href="#">PE7018-20</a>	\$542.36	71				
			Yes		30	<a href="#">PE7018-30</a>	\$616.32	71				
			Yes		40	<a href="#">PE7018-40</a>	\$648.29	71				
			Yes		10	<a href="#">PE7357-10</a>	\$422.45	72				
			Yes		20	<a href="#">PE7357-20</a>	\$343.45	72				
			Yes		30	<a href="#">PE7357-30</a>	\$422.45	72				
			Yes		40	<a href="#">PE7357-40</a>	\$431.97	72				
			Yes		3	<a href="#">PE7357-3</a>	\$422.45	72				
			Yes		6	<a href="#">PE7357-6</a>	\$327.42	72				
			Yes		10	<a href="#">PE7363-10</a>	\$418.81	73				
			Yes		20	<a href="#">PE7363-20</a>	\$418.81	73				
			Yes		30	<a href="#">PE7363-30</a>	\$418.81	73				
			Yes		6	<a href="#">PE7363-6</a>	\$418.81	73				
	18 GHz	TNC Male	TNC Female		1.4:1	Yes	40	<a href="#">PE7363-40</a>	\$453.63		73	
					Yes	1	<a href="#">PE7054-1</a>	\$585.78	74			
Yes				2	<a href="#">PE7054-2</a>	\$585.78	74					
Yes				3	<a href="#">PE7054-3</a>	\$585.78	74					
Yes				10	<a href="#">PE7054-10</a>	\$775.78	74					
Yes				20	<a href="#">PE7054-20</a>	\$745.94	74					
Yes				30	<a href="#">PE7054-30</a>	\$745.94	74					
Yes				40	<a href="#">PE7054-40</a>	\$636.90	74					
Yes				20	<a href="#">PE7375-20</a>	\$404.08	75					
Yes				30	<a href="#">PE7375-30</a>	\$385.21	75					
Yes				40	<a href="#">PE7375-40</a>	\$399.49	75					
7.5 GHz				7/16 DIN Male	7/16 DIN Female	1.3:1	No	50	<a href="#">PE7312-50</a>	\$503.28	76	
	1.45:1	No	10			<a href="#">PE7042-10</a>	\$679.37	77				
	No	20	<a href="#">PE7042-20</a>			\$544.89	77					
	No	30	<a href="#">PE7042-30</a>			\$626.85	77					
	No	40	<a href="#">PE7042-40</a>			\$457.42	77					
	No	3	<a href="#">PE7312-3</a>			\$527.96	78					
	No	6	<a href="#">PE7312-6</a>			\$503.28	78					
	No	10	<a href="#">PE7312-10</a>			\$527.96	78					
	No	20	<a href="#">PE7312-20</a>			\$522.91	78					

Attenuators & Equalizers

See Our Website For Current Pricing & Real-Time Stock Availability!

\* Bi-Dir is Bi-Directional. If No then Attenuator is Directional. Maximum power applies to input connector only.

## Fixed Attenuators

50 Ohm



Max. Power (Watts)	Connector Input	Connector Output	Max. Freq.	Construction Material	VSWR Max.	Bi-Dir.*	ATTN. (dB)	Model No	1 Pc. Price	See Web for Volume Pricing	ROW					
50 W	7/16 DIN Male	7/16 DIN Female	7.5 GHz	Black Anodized Aluminum Heatsink	1.45:1	No	30	<a href="#">PE7312-30</a>	\$503.28	See Web for Volume Pricing	78					
						No	40	<a href="#">PE7312-40</a>	\$503.28							
	7/16 DIN Male	7/16 DIN Female	7.5 GHz		6 GHz	1.3:1	No	50	<a href="#">PE7310-50</a>		\$503.28	79				
							No	3	<a href="#">PE7310-3</a>		\$527.96					
					No	6	<a href="#">PE7310-6</a>	\$503.28								
					No	10	<a href="#">PE7310-10</a>	\$527.96								
					No	20	<a href="#">PE7310-20</a>	\$503.28								
					No	30	<a href="#">PE7310-30</a>	\$503.28								
					No	40	<a href="#">PE7310-40</a>	\$503.28								
					1.3:1	No	50	<a href="#">PE7313-50</a>	\$509.90							
						No	3	<a href="#">PE7313-3</a>	\$509.90							
					7/16 DIN Female	7/16 DIN Female	7.5 GHz	6 GHz	1.45:1		No		6	<a href="#">PE7313-6</a>	\$593.36	80
	No	10	<a href="#">PE7313-10</a>								\$509.90					
	No	20	<a href="#">PE7313-20</a>					\$509.90								
	1.3:1	No	50					<a href="#">PE7316-50</a>	\$473.11							
		No	3					<a href="#">PE7316-3</a>	\$451.01							
	N Female	N Female	7.5 GHz					6 GHz	1.3:1		No	50	<a href="#">PE7321-50</a>	\$449.68	81	
											No	3	<a href="#">PE7316-3</a>	\$451.01		
								7.5 GHz	1.45:1		No	6	<a href="#">PE7316-6</a>	\$451.01		
					No	10	<a href="#">PE7316-10</a>				\$451.01					
					18 GHz	1.6:1	No	20	<a href="#">PE7316-20</a>		\$451.01					
							No	30	<a href="#">PE7316-30</a>		\$451.01					
	N Male	7/16 DIN Female	7/16 DIN Female		6 GHz	1.3:1	No	50	<a href="#">PE7314-50</a>		\$451.01	82				
							No	3	<a href="#">PE7314-3</a>		\$451.01					
					7.5 GHz	1.45:1	No	6	<a href="#">PE7314-6</a>		\$451.01					
							No	10	<a href="#">PE7314-10</a>		\$451.01					
							No	20	<a href="#">PE7314-20</a>		\$451.01					
							No	30	<a href="#">PE7314-30</a>		\$451.01					
No				40			<a href="#">PE7314-40</a>	\$451.01								
3 GHz				1.15:1			No	3	<a href="#">PE7388-3</a>	\$258.35						
							No	6	<a href="#">PE7388-6</a>	\$258.35						
							No	10	<a href="#">PE7388-10</a>	\$265.01						
		No	15		<a href="#">PE7388-15</a>	\$265.01										
		No	20		<a href="#">PE7388-20</a>	\$266.07										
		No	30		<a href="#">PE7388-30</a>	\$255.98										
N Female		N Female	4 GHz	1.35:1	No	40	<a href="#">PE7388-40</a>	\$284.52	83							
					Yes	3	<a href="#">PE7389-3</a>	\$226.27								
				Yes	6	<a href="#">PE7389-6</a>	\$226.27									
				Yes	10	<a href="#">PE7389-10</a>	\$226.27									
				Yes	15	<a href="#">PE7389-15</a>	\$226.27									
				Yes	20	<a href="#">PE7389-20</a>	\$227.14									
				Yes	30	<a href="#">PE7389-30</a>	\$227.14									
				Yes	40	<a href="#">PE7389-40</a>	\$237.96									
				1.35:1	Yes	2	<a href="#">PE7394-2</a>	\$297.73								
					Yes	3	<a href="#">PE7394-3</a>	\$346.77								
1.3:1		Yes	6	<a href="#">PE7394-6</a>	\$281.92											
		Yes	10	<a href="#">PE7394-10</a>	\$281.92											
		Yes	30	<a href="#">PE7394-30</a>	\$296.31											
		Yes	40	<a href="#">PE7394-40</a>	\$298.53											
18 GHz		1.45:1	No	50	<a href="#">PE7322-50</a>	\$473.23	84									
	No		6	<a href="#">PE7019-6</a>	\$610.84											
	No		10	<a href="#">PE7019-10</a>	\$670.63											
	No		20	<a href="#">PE7019-20</a>	\$650.83											
	No		30	<a href="#">PE7019-30</a>	\$629.41											
	No		40	<a href="#">PE7019-40</a>	\$651.93											
	1.6:1		No	3	<a href="#">PE7322-3</a>	\$540.24										
			No	6	<a href="#">PE7322-6</a>	\$540.24										
			No	10	<a href="#">PE7322-10</a>	\$540.24										
			No	20	<a href="#">PE7322-20</a>	\$627.33										
No	30	<a href="#">PE7322-30</a>	\$540.24													

\* Bi-Dir is Bi-Directional. If No then Attenuator is Directional. Maximum power applies to input connector only.

Attenuators & Equalizers

See Our Website For Current Pricing & Real-Time Stock Availability!

## Fixed Attenuators

**50 Ohm**



Max. Power (Watts)	Connector Input	Connector Output	Max. Freq.	Construction Material	VSWR Max.	Bi-Dir.*	ATTN. (dB)	Model No	1 Pc. Price	See Web for Volume Pricing	ROW
<b>50 W</b>	N Male	N Female	18 GHz	Black Anodized Aluminum Heatsink	1.6:1	No	40	<a href="#">PE7322-40</a>	\$473.23	See Web for Volume Pricing	91
			6 GHz				1.3:1	No	50		<a href="#">PE7311-50</a>
	7/16 DIN Male	7.5 GHz	1.45:1		No	3	<a href="#">PE7311-3</a>	\$443.07	93		
					No	6	<a href="#">PE7311-6</a>	\$443.07			
					No	10	<a href="#">PE7311-10</a>	\$443.07			
					No	20	<a href="#">PE7311-20</a>	\$460.35			
					No	30	<a href="#">PE7311-30</a>	\$460.35			
					No	40	<a href="#">PE7311-40</a>	\$443.07			
	7/16 DIN Female	7.5 GHz	1.45:1		No	50	<a href="#">PE7315-50</a>	\$449.68	94		
					No	3	<a href="#">PE7315-3</a>	\$449.68			
					No	6	<a href="#">PE7315-6</a>	\$449.68			
					No	10	<a href="#">PE7315-10</a>	\$449.68			
					No	20	<a href="#">PE7315-20</a>	\$449.68			
					No	30	<a href="#">PE7315-30</a>	\$449.68			
	N Female	N Male	18 GHz		1.6:1	No	40	<a href="#">PE7315-40</a>	\$471.73		95
						No	50	<a href="#">PE7317-50</a>	\$557.56		
						No	3	<a href="#">PE7317-3</a>	\$540.24		
						No	6	<a href="#">PE7317-6</a>	\$540.24		
						No	10	<a href="#">PE7317-10</a>	\$540.24		
						No	20	<a href="#">PE7317-20</a>	\$559.88		
	N Female	N Female	6 GHz		1.3:1	No	30	<a href="#">PE7317-30</a>	\$540.24		96
						No	40	<a href="#">PE7317-40</a>	\$551.06		
						No	50	<a href="#">PE7323-50</a>	\$449.61		
						No	3	<a href="#">PE7323-3</a>	\$471.64		
						No	6	<a href="#">PE7323-6</a>	\$471.64		
						No	10	<a href="#">PE7323-10</a>	\$545.91		
	SMA Male	SMA Female	18 GHz		1.6:1	No	20	<a href="#">PE7323-20</a>	\$626.48		97
						No	30	<a href="#">PE7323-30</a>	\$548.49		
						No	40	<a href="#">PE7323-40</a>	\$551.06		
						No	6	<a href="#">PE7020-6</a>	\$726.24		
						No	10	<a href="#">PE7020-10</a>	\$726.24		
						No	20	<a href="#">PE7020-20</a>	\$648.15		
	SMA Female	SMA Female	18 GHz		1.45:1	No	30	<a href="#">PE7020-30</a>	\$641.31		98
						No	40	<a href="#">PE7020-40</a>	\$639.39		
						Yes	3	<a href="#">PE7427-03</a>	\$549.63		
						Yes	6	<a href="#">PE7427-06</a>	\$549.63		
Yes				10		<a href="#">PE7427-10</a>	\$549.63				
Yes				10		<a href="#">PE7427-30-10</a>	Call				
TNC Male	TNC Female	18 GHz	1.35:1	Yes	15	<a href="#">PE7427-15</a>	\$529.00	99			
				Yes	20	<a href="#">PE7427-20</a>	\$549.63				
				Yes	30	<a href="#">PE7427-30</a>	\$549.63				
				Yes	40	<a href="#">PE7427-40</a>	\$529.00				
				No	6	<a href="#">PE7337-6</a>	\$523.24				
				No	10	<a href="#">PE7337-10</a>	\$523.24				
TNC Female	TNC Female	18 GHz	1.6:1	No	20	<a href="#">PE7337-20</a>	\$523.24	1			
				No	30	<a href="#">PE7337-30</a>	\$523.24				
				No	40	<a href="#">PE7337-40</a>	\$529.41				
				No	50	<a href="#">PE7337-50</a>	\$622.36				
				No	10	<a href="#">PE7055-10</a>	\$1,011.86				
				No	20	<a href="#">PE7055-20</a>	\$843.22				
<b>100 W</b>	7/16 DIN Male	7/16 DIN Female	1.5 GHz	1.25:1	No	30	<a href="#">PE7055-30</a>	\$789.25	2		
					No	40	<a href="#">PE7055-40</a>	\$765.40			
					No	10	<a href="#">PE7351-10</a>	\$501.57			
					No	20	<a href="#">PE7351-20</a>	\$501.57			
					No	40	<a href="#">PE7351-40</a>	\$601.88			
					No	50	<a href="#">PE7351-50</a>	\$501.57			
	7/16 DIN Male	N Female	6 GHz	1.45:1	No	10	<a href="#">PE7043-10</a>	\$699.00	3		
					No	20	<a href="#">PE7043-20</a>	\$612.99			
					No	30	<a href="#">PE7043-30</a>	\$612.99			
					No	3	<a href="#">PE7203-3</a>	\$839.46			
					No	6	<a href="#">PE7203-6</a>	\$807.95			
					No	10	<a href="#">PE7203-10</a>	\$839.46			
N Female	N Female	6 GHz	1.45:1	No	20	<a href="#">PE7203-20</a>	\$880.60	4			
				No	30	<a href="#">PE7203-30</a>	\$807.95				
				No	40	<a href="#">PE7203-40</a>	\$897.08				
				No	50	<a href="#">PE7203-50</a>	\$897.08				
				No	60	<a href="#">PE7203-60</a>	\$987.37				
				No	3	<a href="#">PE7211-3</a>	\$739.16				

\* Bi-Dir is Bi-Directional. If No then Attenuator is Directional. Maximum power applies to input connector only.



Technical Support  
+1 (949) 261-1920



Same-Day Shipping,  
Even Custom  
Cable Assemblies

Attenuators & Equalizers

See Our Website For Current Pricing & Real-Time Stock Availability!

## Fixed Attenuators

50 Ohm



Attenuators & Equalizers

See Our Website For Current Pricing & Real-Time Stock Availability!

Max. Power (Watts)	Connector Input	Connector Output	Max. Freq.	Construction Material	VSWR Max.	Bi-Dir.*	ATTN. (dB)	Model No	1 Pc. Price	See Web for Volume Pricing	ROW	
100 W	7/16 DIN Male	N Female	6 GHz	Black Anodized Aluminum Heatsink	1.45:1	No	6	<a href="#">PE7211-6</a>	\$739.16	See Web for Volume Pricing	4	
						No	10	<a href="#">PE7211-10</a>	\$739.16			
						No	20	<a href="#">PE7211-20</a>	\$739.16			
						No	30	<a href="#">PE7211-30</a>	\$775.39			
						No	40	<a href="#">PE7211-40</a>	\$963.78			
						No	50	<a href="#">PE7211-50</a>	\$963.78			
	7/16 DIN Female	7/16 DIN Male				7/16 DIN Female	No	60	<a href="#">PE7211-60</a>			\$794.56
							No	3	<a href="#">PE7201-3</a>			\$807.95
							No	6	<a href="#">PE7201-6</a>			\$807.95
							No	10	<a href="#">PE7201-10</a>			\$839.46
							No	20	<a href="#">PE7201-20</a>			\$847.55
							No	30	<a href="#">PE7201-30</a>			\$807.95
		7/16 DIN Female				N Male	No	40	<a href="#">PE7201-40</a>			\$863.41
							No	50	<a href="#">PE7201-50</a>			\$863.41
							No	60	<a href="#">PE7201-60</a>			\$863.41
							No	3	<a href="#">PE7204-3</a>			\$815.52
							No	6	<a href="#">PE7204-6</a>			\$815.52
							No	10	<a href="#">PE7204-10</a>			\$815.52
		7/16 DIN Female				N Female	No	20	<a href="#">PE7204-20</a>			\$815.52
							No	30	<a href="#">PE7204-30</a>			\$815.52
							No	40	<a href="#">PE7204-40</a>			\$870.97
							No	50	<a href="#">PE7204-50</a>			\$870.97
							No	60	<a href="#">PE7204-60</a>			\$870.97
							No	3	<a href="#">PE7207-3</a>			\$748.22
	N Male					No	6	<a href="#">PE7207-6</a>	\$748.22			
						No	10	<a href="#">PE7207-10</a>	\$748.22			
						No	20	<a href="#">PE7207-20</a>	\$748.22			
						No	30	<a href="#">PE7207-30</a>	\$748.22			
						No	40	<a href="#">PE7207-40</a>	\$803.68			
						No	50	<a href="#">PE7207-50</a>	\$803.68			
	BNC Male	BNC Female				1,000 MHz	No	60	<a href="#">PE7207-60</a>			\$803.68
							No	3	<a href="#">PE7212-3</a>			\$746.72
							No	6	<a href="#">PE7212-6</a>			\$746.72
							No	10	<a href="#">PE7212-10</a>			\$746.72
							No	20	<a href="#">PE7212-20</a>			\$746.72
							No	30	<a href="#">PE7212-30</a>			\$746.72
		N Female					No	40	<a href="#">PE7212-40</a>			\$802.13
							No	50	<a href="#">PE7212-50</a>			\$802.13
							No	60	<a href="#">PE7212-60</a>			\$802.13
							No	3	<a href="#">PE7026-3</a>			\$871.85
							No	6	<a href="#">PE7026-6</a>			\$881.07
							No	10	<a href="#">PE7026-10</a>			\$778.43
7/16 DIN Female			7/16 DIN Female	No	20		<a href="#">PE7026-20</a>	\$881.07				
				No	30		<a href="#">PE7026-30</a>	\$810.90				
				No	40		<a href="#">PE7026-40</a>	\$881.07				
				No	3		<a href="#">PE7205-3</a>	\$748.22				
				No	6		<a href="#">PE7205-6</a>	\$748.22				
				No	10		<a href="#">PE7205-10</a>	\$748.22				
N Male	N Female	No	20	<a href="#">PE7205-20</a>	\$748.22							
		No	30	<a href="#">PE7205-30</a>	\$748.22							
		No	40	<a href="#">PE7205-40</a>	\$803.68							
		No	50	<a href="#">PE7205-50</a>	\$803.68							
		No	60	<a href="#">PE7205-60</a>	\$803.68							
		No	6	<a href="#">PE7021-6</a>	\$882.34							
	N Female	N Female	No	10	<a href="#">PE7021-10</a>	\$753.26						
			No	20	<a href="#">PE7021-20</a>	\$738.78						
			No	30	<a href="#">PE7021-30</a>	\$911.72						
			No	40	<a href="#">PE7021-40</a>	\$794.01						
			Yes	3	<a href="#">PE7385-3</a>	\$453.63						
			Yes	6	<a href="#">PE7385-6</a>	\$453.63						
N Female	N Female	Yes	10	<a href="#">PE7385-10</a>	\$453.63							
		Yes	20	<a href="#">PE7385-20</a>	\$453.63							
		Yes	30	<a href="#">PE7385-30</a>	\$453.63							
		Yes	40	<a href="#">PE7385-40</a>	\$464.45							
		Yes	3	<a href="#">PE7421-3</a>	\$529.41							
		Yes	6	<a href="#">PE7421-6</a>	\$529.41							
N Female	N Female	Yes	10	<a href="#">PE7421-10</a>	\$540.24							
		Yes	20	<a href="#">PE7421-20</a>	\$541.10							
		Yes	30	<a href="#">PE7421-30</a>	\$572.72							

\* Bi-Dir is Bi-Directional. If No then Attenuator is Directional. Maximum power applies to input connector only.



## Fixed Attenuators

**50 Ohm**



Max. Power (Watts)	Connector Input	Connector Output	Max. Freq.	Construction Material	VSWR Max.	Bi-Dir.*	ATTN. (dB)	Model No	1 Pc. Price	See Web for Volume Pricing	ROW			
<b>100 W</b>	N Male	N Female	4 GHz	Black Anodized Aluminum Heatsink	1.2:1	No	40	<a href="#">PE7421-40</a>	\$662.35	See Web for Volume Pricing	13			
						No	3	<a href="#">PE7213-3</a>	\$705.93		14			
						No	6	<a href="#">PE7213-6</a>	\$768.24		15			
						No	10	<a href="#">PE7213-10</a>	\$793.06		16			
						No	20	<a href="#">PE7213-20</a>	\$797.72		17			
						No	30	<a href="#">PE7213-30</a>	\$780.74		18			
						No	40	<a href="#">PE7213-40</a>	\$808.59		19			
						No	50	<a href="#">PE7213-50</a>	\$824.12		20			
		No				60	<a href="#">PE7213-60</a>	\$800.88	21					
		TNC Female				No	30	<a href="#">PE7237-30</a>	\$720.59		22			
						No	3	<a href="#">PE7202-3</a>	\$739.16		23			
		N Female				7/16 DIN Male	6 GHz	1.45:1	No		6	<a href="#">PE7202-6</a>	\$739.16	24
									No		10	<a href="#">PE7202-10</a>	\$739.16	25
									No		20	<a href="#">PE7202-20</a>	\$739.16	26
	No		30		<a href="#">PE7202-30</a>				\$767.99		27			
	No		40		<a href="#">PE7202-40</a>				\$794.56		28			
	No		50		<a href="#">PE7202-50</a>				\$794.56		29			
	No		60		<a href="#">PE7202-60</a>				\$794.56		30			
	7/16 DIN Female		No		3				<a href="#">PE7206-3</a>		\$868.95	31		
			No		6				<a href="#">PE7206-6</a>		\$746.72	32		
			No		10				<a href="#">PE7206-10</a>		\$746.72	33		
			No		20				<a href="#">PE7206-20</a>		\$868.96	34		
			No		30				<a href="#">PE7206-30</a>		\$746.72	35		
			No		40				<a href="#">PE7206-40</a>		\$802.13	36		
			No		50				<a href="#">PE7206-50</a>		\$802.13	37		
			No		60	<a href="#">PE7206-60</a>	\$802.13	38						
			N Male		No	3	<a href="#">PE7208-3</a>	\$740.52	39					
					No	6	<a href="#">PE7208-6</a>	\$790.65	40					
					No	10	<a href="#">PE7208-10</a>	\$740.52	41					
					No	20	<a href="#">PE7208-20</a>	\$793.06	42					
					No	30	<a href="#">PE7208-30</a>	\$761.44	43					
					No	40	<a href="#">PE7208-40</a>	\$808.59	44					
	No				50	<a href="#">PE7208-50</a>	\$800.88	45						
	No				60	<a href="#">PE7208-60</a>	\$800.88	46						
	N Female				No	3	<a href="#">PE7214-3</a>	\$784.36	47					
					No	6	<a href="#">PE7214-6</a>	\$768.54	48					
					No	10	<a href="#">PE7214-10</a>	\$776.66	49					
					No	20	<a href="#">PE7214-20</a>	\$784.36	50					
					No	30	<a href="#">PE7214-30</a>	\$784.36	51					
		No			40	<a href="#">PE7214-40</a>	\$799.26	52						
		No	50		<a href="#">PE7214-50</a>	\$829.38	53							
		No	60		<a href="#">PE7214-60</a>	\$810.94	54							
SMA Male		SMA Female	1.5 GHz	1.25:1	No	6	<a href="#">PE7022-6</a>	\$871.85	55					
					No	10	<a href="#">PE7022-10</a>	Call	56					
					No	20	<a href="#">PE7022-20</a>	\$590.57	57					
					No	30	<a href="#">PE7022-30</a>	\$872.76	58					
					No	40	<a href="#">PE7022-40</a>	\$806.77	59					
					No	50	<a href="#">PE7227-50</a>	\$730.23	60					
SMA Female	SMA Male	6 GHz	1.45:1	No	60	<a href="#">PE7227-60</a>	\$792.77	61						
				No	3	<a href="#">PE7221-3</a>	\$679.16	62						
				No	6	<a href="#">PE7221-6</a>	\$705.65	63						
				No	10	<a href="#">PE7221-10</a>	\$705.65	64						
				No	20	<a href="#">PE7221-20</a>	\$705.65	65						
				No	20	<a href="#">PE7221-20</a>	\$705.65	66						

**Attenuators & Equalizers**

See Our Website For Current Pricing & Real-Time Stock Availability!

\* Bi-Dir is Bi-Directional. If No then Attenuator is Directional. Maximum power applies to input connector only.

## Fixed Attenuators

### 50 Ohm



Max. Power (Watts)	Connector Input	Connector Output	Max. Freq.	Construction Material	VSWR Max.	Bi-Dir.*	ATTN. (dB)	Model No	1 Pc. Price	See Web for Volume Pricing				ROW
100 W	SMA Female	SMA Male	6 GHz	Black Anodized Aluminum Heatsink	1.45:1	No	40	<a href="#">PE7221-40</a>	\$766.01	See Web for Volume Pricing				22
		SMA Female				No	50	<a href="#">PE7221-50</a>	\$737.26					23
						No	60	<a href="#">PE7221-60</a>	\$792.77					24
						No	3	<a href="#">PE7228-3</a>	\$702.25					
						No	20	<a href="#">PE7228-20</a>	\$749.76					
						No	30	<a href="#">PE7228-30</a>	\$786.52					
	TNC Male	TNC Female	1.5 GHz		1.15:1	No	30	<a href="#">PE7056-30</a>	\$849.12					25
	TNC Female	N Male	6 GHz		1.45:1	No	30	<a href="#">PE7210-30</a>	\$693.54					
		N Female				No	3	<a href="#">PE7218-3</a>	\$692.02					
	150 W	N Male	N Female		8 GHz	Black Anodized Aluminum Heatsink	1.5:1	No	3					<a href="#">PE7AP150-03</a>
No				6				<a href="#">PE7AP150-06</a>	\$686.68					
No				10				<a href="#">PE7AP150-10</a>	\$713.46					
No				20				<a href="#">PE7AP150-20</a>	\$713.46					
No				30				<a href="#">PE7AP150-30</a>	\$713.46					
200 W	N Male	N Female	3 GHz	Black Anodized Aluminum Heatsink	1.35:1	No	10	<a href="#">PE7387-10</a>	\$643.09	See Web for Volume Pricing				28
						No	20	<a href="#">PE7387-20</a>	\$648.50					
						No	30	<a href="#">PE7387-30</a>	\$649.36					
						No	40	<a href="#">PE7387-40</a>	\$670.87					
300 W	N Male	N Female	1,000 MHz	Black Anodized Aluminum Heatsink	1.4:1	No	3	<a href="#">PE7031-3</a>	\$2,038.52	See Web for Volume Pricing				29
						No	6	<a href="#">PE7031-6</a>	\$1,764.10					
						No	10	<a href="#">PE7031-10</a>	\$1,832.90					
						No	20	<a href="#">PE7031-20</a>	\$1,906.21					
	N Female	3 GHz	Black Aluminum Heatsink	No	3-3	<a href="#">PE7411-3</a>	\$1,166.86	30						
500 W	N Male	N Female	1,000 MHz	Black Anodized Aluminum Heatsink	1.15:1	No	6	<a href="#">PE7032-6</a>	\$2,230.24	See Web for Volume Pricing				31
						No	30	<a href="#">PE7032-30</a>	\$2,230.24					
			2.4 GHz		1.35:1	No	30	<a href="#">PE7084-30</a>	\$928.68					32
						No	2	<a href="#">PE7085-2</a>	\$2,380.72					33
1000 W	N Male	N Female	2.5 GHz	Black Aluminum Heatsink	1.35:1	No	10-10	<a href="#">PE7085-10</a>	\$2,380.72	See Web for Volume Pricing				
						No	30-30	<a href="#">PE7423-30</a>	\$3,808.57					34
						No	40	<a href="#">PE7423-40</a>	\$3,808.57					

### 75 Ohm



Max. Power (Watts)	Connector Input	Connector Output	Max. Freq.	Construction Material	VSWR Max.	Bi-Dir.*	ATTN. (dB)	Model No	1-24	25-49	50-99	100+	ROW
1 W	BNC Male	BNC Female	1,000 MHz	Nickel Plated Brass	1.2:1	Yes	1	<a href="#">PE7009-1</a>	\$65.49	\$62.22	\$58.94	\$56.32	35
						Yes	2	<a href="#">PE7009-2</a>	\$65.49	\$62.22	\$58.94	\$56.32	
						Yes	3	<a href="#">PE7009-3</a>	\$59.42	\$56.45	\$53.48	\$51.10	
						Yes	6	<a href="#">PE7009-6</a>	\$60.39	\$57.37	\$54.35	\$51.94	

\* Bi-Dir is Bi-Directional. If No then Attenuator is Directional. Maximum power applies to input connector only.

Attenuators & Equalizers

See Our Website For Current Pricing & Real-Time Stock Availability!

75 Ohm



Max. Power (Watts)	Connector Input	Connector Output	Max. Freq.	Construction Material	VSWR Max.	Bi-Dir.*	ATTN. (dB)	Model No	1 Pc. Price	See Web for Volume Pricing	ROW
1 W	BNC Male	BNC Female	1,000 MHz	Nickel Plated Brass	1.2:1	Yes	10	<a href="#">PE7009-10</a>	\$59.42	See Web for Volume Pricing	35
						Yes	20	<a href="#">PE7009-20</a>	\$59.42		
						Yes	30	<a href="#">PE7009-30</a>	\$59.42		
	N Male	N Female				Yes	1	<a href="#">PE7029-1</a>	\$68.08		
						Yes	3	<a href="#">PE7029-3</a>	\$79.22		
						Yes	6	<a href="#">PE7029-6</a>	\$79.22		
						Yes	10	<a href="#">PE7029-10</a>	\$88.73		
2 W	BNC Male	BNC Female	4 GHz	Nickel Plated Brass	1.35:1	Yes	20	<a href="#">PE7029-20</a>	\$70.74		
						Yes	30	<a href="#">PE7029-30</a>	\$81.20		
						Yes	1	<a href="#">PE7050-1</a>	\$139.66		
						Yes	2	<a href="#">PE7050-2</a>	\$139.66		
						Yes	3	<a href="#">PE7050-3</a>	\$128.84		
						Yes	6	<a href="#">PE7050-6</a>	\$128.84		
F Male	F Female	1,000 MHz	Tri-Metal Plated Brass	1.3:1	Yes	10	<a href="#">PE7050-10</a>	\$154.60			
					Yes	20	<a href="#">PE7050-20</a>	\$154.60			
					Yes	30	<a href="#">PE7050-30</a>	\$128.84			
					Yes	1	<a href="#">PE7057-1</a>	\$88.44			
					Yes	2	<a href="#">PE7057-2</a>	\$88.44			
					Yes	3	<a href="#">PE7057-3</a>	\$116.01			
		4 GHz	Passivated Stainless Steel	4 GHz	Passivated Stainless Steel	4 GHz	1.3:1	Yes	6	<a href="#">PE7057-6</a>	\$116.01
								Yes	10	<a href="#">PE7057-10</a>	\$118.01
									1	<a href="#">PE7396-1</a>	\$74.70
									2	<a href="#">PE7396-2</a>	\$74.70
									3	<a href="#">PE7396-3</a>	\$70.15
									4	<a href="#">PE7396-4</a>	\$89.64
									5	<a href="#">PE7396-5</a>	\$89.64
N Male	N Female	4 GHz	Passivated Stainless Steel	4 GHz	1.3:1		6	<a href="#">PE7396-6</a>	\$69.29		
							7	<a href="#">PE7396-7</a>	\$89.64		
							8	<a href="#">PE7396-8</a>	\$89.64		
							9	<a href="#">PE7396-9</a>	\$83.15		
							10	<a href="#">PE7396-10</a>	\$70.15		
							16	<a href="#">PE7396-16</a>	\$89.64		
							20	<a href="#">PE7396-20</a>	\$69.29		
						Yes	1	<a href="#">PE7044-1</a>	\$161.32		
						Yes	2	<a href="#">PE7044-2</a>	\$161.32		
						Yes	3	<a href="#">PE7044-3</a>	\$158.92		
Yes	6	<a href="#">PE7044-6</a>	\$180.59								
Yes	10	<a href="#">PE7044-10</a>	\$158.92								
Yes	20	<a href="#">PE7044-20</a>	\$158.92								
Yes	30	<a href="#">PE7044-30</a>	\$158.92								

Attenuators & Equalizers

See Our Website For Current Pricing & Real-Time Stock Availability!

Step Attenuators, Push Button

50 Ohm



Max. Power (Watts)	Conn. Input	Conn. Output	Frequency Range (MHz)	Construction Material	VSWR Max. (MHz)	ATTN. Range (dB)	Step Size (dB)	Model No	1 Pc. Price	See Web for Volume Pricing	ROW
1 W	BNC Female	BNC Female	DC-750	Brass	DC-100: 1.1:1 100-300: 1.25:1 300-500: 1.25:1 500-750: 1.4:1	0-65	1.0	<a href="#">PE7008-1</a>	\$903.91	See Web for Volume Pricing	41
					1.4:1	0-82.5		<a href="#">PE70A1021</a>	\$1,462.61		42
					DC-100: 1.1:1 100-300: 1.25:1 300-500: 1.25:1 500-750: 1.4:1	0-45.5	0.5	<a href="#">PE7008-2</a>	\$949.00		43
					1.4:1	0-82.5	0.5	<a href="#">PE7008-6</a>	\$1,148.53		
						0-102	1.0	<a href="#">PE7008-5</a>	\$1,246.50		

\* Bi-Dir is Bi-Directional. If No then Attenuator is Directional. Maximum power applies to input connector only.



Technical Support  
+1 (949) 261-1920



Same-Day Shipping,  
Even Custom Cable Assemblies

75 Ohm													
Max. Power (Watts)	Conn. Input	Conn. Output	Frequency Range (MHz)	Construction Material	VSWR Max. (MHz)	ATTN. Range (dB)	Step Size (dB)	Model No	1-4	5-9	10-24	25+	ROW
1 W	BNC Female	BNC Female	DC-500	Brass	DC-100: 1.1:1 100-300: 1.2:1 300-500: 1.3:1	0-45.5	0.5	<a href="#">PE7008-4</a>	\$814.80	\$774.06	\$733.32	\$700.73	43
						0-65	1.0	<a href="#">PE7008-3</a>	\$915.66	\$869.88	\$824.09	\$787.47	



Step Attenuators, Toggle													
75 Ohm													
Max. Power (Watts)	Conn. Input	Conn. Output	Frequency Range (MHz)	Construction Material	VSWR Max. (MHz)	ATTN. Range (dB)	Step Size (dB)	Model No	1-4	5-9	10-24	25+	ROW
1 W	BNC Female	BNC Female	DC-1,000	Aluminum	1.3:1	0-42		<a href="#">PE70A1001</a>	\$718.15	\$682.24	\$646.34	\$617.61	44
	F Female	F Female	0.3-1,000		1.37:1	0-71		<a href="#">PE70A1008</a>	\$783.99	\$744.79	\$705.59	\$674.23	45



Step Attenuators, Rotary													
50 Ohm													
Max. Power (Watts)	Conn. Input	Conn. Output	Frequency Range (MHz)	Construction Material	VSWR Max. (MHz)	ATTN. Range (dB)	Step Size (dB)	Model No	1 Pc. Price	See Web for Volume Pricing			ROW
1 W	BNC Female	BNC Female	DC-1,000	Aluminum	1.2:1	0-1	0.1	<a href="#">PE7034-1</a>	\$616.01	See Web for Volume Pricing			46
					DC-1,000: 1.2:1	0-100	10.0	<a href="#">PE7034-2</a>	\$732.04				
2 W	BNC Female	BNC Female	DC-2,000	Aluminum	DC-1,000: 1.2:1 1,000-2,200: 1.4:1	0-1	0.1	<a href="#">PE7034-6</a>	\$644.02				
						0-10	1.0	<a href="#">PE70A1024</a>	\$636.72				
						0-70	10.0	<a href="#">PE70A1022</a>	\$666.95				
						0-10	1.0	<a href="#">PE70A1025</a>	\$624.23				
						0-70	10.0	<a href="#">PE70A1023</a>	\$644.81				



75 Ohm													
Max. Power (Watts)	Conn. Input	Conn. Output	Frequency Range (MHz)	Construction Material	VSWR Max. (MHz)	ATTN. Range (dB)	Step Size (dB)	Model No	1 Pc. Price	See Web for Volume Pricing			ROW
1 W	BNC Female	BNC Female	DC-500	Aluminum	DC-500: 1.3:1 500-1,000: 1.4:1	0-1	0.1	<a href="#">PE7035-1</a>	\$486.95	See Web for Volume Pricing			51
			DC-1,000			0-10	1.0	<a href="#">PE7035-2</a>	\$424.59				
						0-1	0.1	<a href="#">PE7035-5</a>	\$962.47				



## DC Bias Attenuators

### 50 Ohm



Max. Power (Watts)	Conn. Input	Conn. Output	Frequency Range (MHz)	Construction Material	VSWR Max.	Max. V (V)	Max. I (Amp)	ATTN. (dB)	Model No	1-9	10-24	25-49	50+	ROW
<b>2 W</b>	N Male	N Female	500-2,000	Passivated Stainless Steel	1.35:1	100	2	6	<a href="#">PE7062-6</a>	\$173.90	\$165.21	\$156.51	\$149.55	52
								10	<a href="#">PE7062-10</a>	\$168.22	\$159.81	\$151.40	\$144.67	
								20	<a href="#">PE7062-20</a>	\$146.45	\$139.13	\$131.81	\$125.95	
	SMA Male	SMA Female						6	<a href="#">PE7061-6</a>	\$142.50	\$135.38	\$128.25	\$122.55	53
								10	<a href="#">PE7061-10</a>	\$142.50	\$135.38	\$128.25	\$122.55	
								20	<a href="#">PE7061-20</a>	\$154.60	\$146.87	\$139.14	\$132.96	
	TNC Male	TNC Female						6	<a href="#">PE7063-6</a>	\$156.51	\$148.68	\$140.86	\$134.60	54
								10	<a href="#">PE7063-10</a>	\$180.59	\$171.56	\$162.53	\$155.31	
								20	<a href="#">PE7063-20</a>	\$180.59	\$171.56	\$162.53	\$155.31	

### 75 Ohm



Max. Power (Watts)	Conn. Input	Conn. Output	Frequency Range (MHz)	Construction Material	VSWR Max.	Max. V (V)	Max. I (Amp)	ATTN. (dB)	Model No	1-9	10-24	25-49	50+	ROW
<b>2 W</b>	F Male	F Female	500-2,000	Brass	1.45:1	100	2	6	<a href="#">PE7064-6</a>	\$182.97	\$173.82	\$164.67	\$157.35	55
								10	<a href="#">PE7064-10</a>	\$182.97	\$173.82	\$164.67	\$157.35	
								20	<a href="#">PE7064-20</a>	\$182.97	\$173.82	\$164.67	\$157.35	

## Continuously Variable Attenuators

### 50 Ohm



Max. Power (Watts)	Conn. Input	Conn. Output	Frequency Range (MHz)	Construction Material	VSWR Max.	ATTN. (dB)	Model No	1	2-4	5-9	10+	ROW
<b>5 W</b>	SMA Female	SMA Female	DC-4,000		DC-1,000: 1.5:1	5-95	<a href="#">PE7422</a>	\$1,640.17	\$1,574.56	\$1,508.96	\$1,443.35	56
					1,000-2,000: 1.6:1							
					2,000-3,000: 1.7:1							
					3,000-4,000: 1.8:1							

## Waveguide Attenuators, See Page [340](#), [348](#)

## ACTIVE ATTENUATORS

### TTL, USB, CMOS and Relay



Type	Frequency Range (GHz)	Atten. Range (dB)	IL (dB)	Step Resolution (dB)	Switching Speed (µs)	Input/Output Connector	Model No	1 Pc. Price	See Web for Volume Pricing	ROW
CMOS	DC - 13	0 - 31.5	5	0.5	6,000,000	SMA Female	<a href="#">PE70A5003</a>	\$4,585.27	See Web for Volume Pricing	57
Relay	DC - 1		1.5				<a href="#">PE70A8001</a>	\$868.82		
	DC - 1	0 - 63	1.5	<a href="#">PE70A8000</a>		\$902.70				
	DC - 1		2.2	F Female		<a href="#">PE70A8003</a>	\$1,686.66			
	DC - 1	2.5	<a href="#">PE70A8004</a>			\$2,008.12				
	DC - 1.5	0 - 127	3.2	<a href="#">PE70A8005</a>		\$2,152.36				
DC - 2	0 - 63.75	0.25	<a href="#">PE70A8002</a>	\$2,942.29	63					



Technical Support  
+1 (949) 261-1920



Same-Day Shipping,  
Even Custom Cable Assemblies

Attenuators & Equalizers

See Our Website For Current Pricing & Real-Time Stock Availability!

## TTL, USB, CMOS and Relay



Type	Frequency Range (GHz)	Atten. Range (dB)	IL (dB)	Step Resolution (dB)	Switching Speed (µs)	Input/Output Connector	Model No	1	2-4	5-9	10+	R O W			
TTL	DC - 13	0 - 31.5	5.5	0.5	45	SMA Female	<a href="#">PE70A4000</a>	\$4,935.25	\$4,737.84	\$4,540.43	\$4,343.02	64			
	5 MHz - 2.15	0 - 63	5.25	1	5,000	F Female	<a href="#">PE70A5012</a>	\$1,987.83	\$1,908.32	\$1,828.80	\$1,749.29	65			
	30 MHz - 3	0 - 31.75	2.5	0.25	1,000	SMA Female	<a href="#">PE70A5004</a>	\$1,560.02	\$1,497.62	\$1,435.22	\$1,372.82	66			
	30 MHz - 3	0 - 63	4	1			<a href="#">PE70A5006</a>	\$1,436.63	\$1,379.16	\$1,321.70	\$1,264.23	67			
	30 MHz - 3	0 - 63.5	4	0.5			<a href="#">PE70A5005</a>	\$1,496.97	\$1,437.09	\$1,377.21	\$1,317.33	68			
	30 MHz - 3	0 - 95	6	1			<a href="#">PE70A5007</a>	\$2,001.26	\$1,921.21	\$1,841.16	\$1,761.11	69			
	30 MHz - 6	0 - 60	4	0.25	50,000	2.92mm Female	<a href="#">PE70A5000</a>	\$6,002.99	\$5,762.87	\$5,522.75	\$5,282.63	70			
	100 MHz - 18	0 - 30	5	1	<a href="#">PE70A5001</a>		\$7,016.34	\$6,735.69	\$6,455.03	\$6,174.38	71				
	100 MHz - 40		8		<a href="#">PE70A5002</a>		\$10,215.58	\$9,806.96	\$9,398.33	\$8,989.71	72				
	200 MHz - 6	0 - 63	5.5		<a href="#">PE70A5009</a>	\$1,496.97	\$1,437.09	\$1,377.21	\$1,317.33	73					
Bench-Top TTL	200 MHz - 6	0 - 95	8	1	1,000	SMA Female	<a href="#">PE70A5013</a>	\$9,325.93	\$8,952.89	\$8,579.86	\$8,206.82	74			
	200 MHz - 6		8				<a href="#">PE70A5010</a>	\$1,926.14	\$1,849.09	\$1,772.05	\$1,695.00	75			
TTL	450 MHz - 2.15	0 - 127	4.5	0.06	2,000	F Female	<a href="#">PE70A5011</a>	\$2,011.27	\$1,930.82	\$1,850.37	\$1,769.92	76			
	500 MHz - 18	0 - 60	4.5				<a href="#">PE70A6000</a>	\$7,114.79	\$6,830.20	\$6,545.61	\$6,261.02	77			
	700 MHz - 3	0 - 127	6				1	5,000	SMA Female	<a href="#">PE70A5008</a>	\$1,923.31	\$1,846.38	\$1,769.45	\$1,692.51	78
	18 - 40	0 - 30	5				1	0.03	1	2.4mm Female	<a href="#">PE70A6001</a>	\$7,023.63	\$6,742.68	\$6,461.74	\$6,180.79
	SMA Female			<a href="#">PE70A3900</a>	\$4,169.44	\$4,002.66				\$3,835.88	\$3,669.11	80			
USB	100 MHz - 18	0 - 30	5	1	4,000	2.92mm Female	<a href="#">PE70A3901</a>	\$5,669.20	\$5,442.43	\$5,215.66	\$4,988.90	81			
	200 MHz - 6					SMA Female	<a href="#">PE70A3902</a>	\$2,001.26	\$1,921.21	\$1,841.16	\$1,761.11	82			

## Variable Voltage Attenuators



Frequency Range (GHz)	Atten. Range (dB)	Insertion Loss (dB)	Switching Speed (µsec)	Input / Output Connectors	Model No	1	2-4	5-9	10+	R O W
DC - 20	0 - 30	3	50,000	SMA Female	<a href="#">PE70A1017</a>	\$8,188.88	\$7,861.32	\$7,533.77	\$7,206.21	83
50 MHz - 2.2	0 - 20				<a href="#">PE70A1031</a>	\$1,331.86	\$1,278.59	\$1,225.31	\$1,172.04	84
400 MHz - 6	0 - 40				<a href="#">PE70A1000</a>	\$6,346.97	\$6,093.09	\$5,839.21	\$5,585.33	85
500 MHz - 18	0 - 60	4.5	3,000	SMA Female	<a href="#">PE70A2900</a>	\$6,313.29	\$6,060.76	\$5,808.23	\$5,555.70	86
2 - 4		2	500		<a href="#">PE70A2000</a>	\$5,329.04	\$5,115.88	\$4,902.72	\$4,689.56	87
4 - 8		2.5			<a href="#">PE70A2001</a>	\$6,244.96	\$5,995.16	\$5,745.36	\$5,495.56	88
6 - 12		2.8			<a href="#">PE70A2002</a>	\$6,172.69	\$5,925.78	\$5,678.87	\$5,431.97	89
8 - 18		3.7			<a href="#">PE70A2003</a>	\$6,960.53	\$6,682.11	\$6,403.69	\$6,125.27	90

## EQUALIZERS

### Positive Slope



Frequency Range (GHz)	Typ. Equalizing Value (dB)	Typ. Small Signal IL (dB)	Typ Input-Output VSWR	Max. RF Input Power (dBm)	In-Out Connectors (Field Replaceable)	Model No	1-4	5-9	10-24	25+	R O W
0.5 MHz - 2	2	1.4	1.8:1	+30	SMA Female	<a href="#">PE70A9000</a>	\$646.67	\$614.34	\$582.00	\$556.14	91
	4	1				<a href="#">PE70A9001</a>	\$663.33	\$630.16	\$597.00	\$570.46	92
	6	1.8				<a href="#">PE70A9002</a>	\$673.33	\$639.66	\$606.00	\$579.06	93
1 - 18	4	1	1.8:1	+30	SMA Female	<a href="#">PE70A9003</a>	\$106.67	\$101.34	\$96.00	\$91.74	94
	6	1				<a href="#">PE70A9004</a>	\$1,153.33	\$1,095.66	\$1,038.00	\$991.86	95
	8	1.5				<a href="#">PE70A9005</a>	\$1,153.33	\$1,095.66	\$1,038.00	\$991.86	96
2 - 6	2	1	1.8:1	+30	SMA Female	<a href="#">PE70A9006</a>	\$923.33	\$877.16	\$831.00	\$794.06	97
	4	1.5				<a href="#">PE70A9007</a>	\$960.00	\$912.00	\$864.00	\$825.60	98
2 - 12	4	1.5	1.8:1	+30	SMA Female	<a href="#">PE70A9008</a>	\$923.33	\$877.16	\$831.00	\$794.06	99

\* Bi-Dir is Bi-Directional. If No then Attenuator is Directional. Maximum power applies to input connector only.

Attenuators & Equalizers

See Our Website For Current Pricing & Real-Time Stock Availability!

## Positive Slope



Frequency Range (GHz)	Typ. Equalizing Value (dB)	Typ. Small Signal IL (dB)	Typ Input-Output VSWR	Max. RF Input Power (dBm)	In-Out Connectors (Field Replaceable)	Model No	1-4	5-9	10-24	25+	ROW
2 - 12	8	2	1.8:1	+30	SMA Female	<a href="#">PE70A9009</a>	\$1,000.00	\$950.00	\$900.00	\$860.00	1
6 - 18	2	2				<a href="#">PE70A9010</a>	\$1,106.67	\$1,051.34	\$996.00	\$951.74	2
	4	2				<a href="#">PE70A9011</a>	\$1,126.67	\$1,070.34	\$1,014.00	\$968.94	3
	6	2				<a href="#">PE70A9012</a>	\$1,153.33	\$1,095.66	\$1,038.00	\$991.86	4
	8	2.5				<a href="#">PE70A9013</a>	\$1,180.00	\$1,121.00	\$1,062.00	\$1,014.80	5
18 - 40	2	2	2:1	+30	2.92mm Female	<a href="#">PE70A9014</a>	\$1,293.33	\$1,228.66	\$1,164.00	\$1,112.26	6
	4	2				<a href="#">PE70A9015</a>	\$1,323.33	\$1,257.16	\$1,191.00	\$1,138.06	7
	6	2				<a href="#">PE70A9016</a>	\$1,346.67	\$1,279.34	\$1,212.00	\$1,158.14	8
26.5 - 40	4	3				<a href="#">PE70A9017</a>	\$1,293.33	\$1,228.66	\$1,164.00	\$1,112.26	9
	5	2.5				<a href="#">PE70A9018</a>	\$1,313.33	\$1,247.66	\$1,182.00	\$1,129.46	10

## BALUNS



Frequency Range (MHz)	Balanced Impedance (Ω)	Unbalanced Impedance (Ω)	Package	Model No	1-9	10-24	25-49	50+	ROW
20 - 520	25	50	Surface Mount	<a href="#">PE2BL1001</a>	\$241.21	\$229.15	\$217.09	\$207.44	11
20 - 1,000				<a href="#">PE2BL1002</a>	\$233.40	\$221.73	\$210.06	\$200.72	12
80 - 1,000				<a href="#">PE2BL1003</a>	\$213.94	\$203.24	\$192.55	\$183.99	13
100 - 520				<a href="#">PE2BL1004</a>	\$233.40	\$221.73	\$210.06	\$200.72	14
225 - 2,000				<a href="#">PE2BL1000</a>	\$227.09	\$215.74	\$204.38	\$195.30	15
500 - 2,000				<a href="#">PE2BL1005</a>	\$218.57	\$207.64	\$196.71	\$187.97	16
800 - 2,500				<a href="#">PE2BL1006</a>	\$269.86	\$256.37	\$242.87	\$232.08	17

## BIAS TEES AND DC BLOCKS

### Bias Tees



Impedance	Frequency Range (MHz.)	Max. V (V)	Max. I (mA)	Connector	Bias Connector	Model No	1 Pc. Price	See Web for Volume Pricing	ROW
50 Ohm	0.03 - 70,000	25	250	1.85mm	SMA	<a href="#">PE1619</a>	\$2,908.98	See Web for Volume Pricing	18
	0.03 - 85,000			<a href="#">PE1620</a>	\$3,128.83	19			
	0.05 - 50,000	2.4mm	SMA	<a href="#">PE1610</a>	\$1,883.87	20			
	0.1 - 12,400	24	750	SMA	Solder Pin	<a href="#">PE1606A</a>	\$571.23		21
				<a href="#">PE1BT1002</a>	\$702.94	22			
	0.1 - 18,000	100	2500	3.5mm	Solder Pin	<a href="#">PE1608</a>	\$1,193.37		23
	10 - 2,500			Solder Pin	<a href="#">PE1611</a>	\$349.79	24		
	10 - 4,000	100	2500	SMA	Solder Pin	<a href="#">PE1613</a>	\$469.79		25
	10 - 6,000			Solder Pin	<a href="#">PE1612</a>	\$315.31	26		
				SMA	Solder Pin	<a href="#">PE1614</a>	\$432.24		27
		Solder Pin	<a href="#">PE1615</a>	\$343.74	28				
	10 - 40,000	100	2500	N	Solder Pin	<a href="#">PE1616</a>	\$412.05		29
				SMA	Pin	<a href="#">PE1621</a>	\$1,190.68		30
	100 - 6,000	50	500	SMA	Solder Pin	<a href="#">PE1604</a>	\$327.47		31
	250 - 2,500	100	7000		Solder Pin	<a href="#">PE1617</a>	\$693.82		32
	400 - 10,000	50	200	SMA	Solder Pin	<a href="#">PE1618</a>	\$778.47		33
					Solder Pin	<a href="#">PE1605</a>	\$509.26		34
	500 - 10,000				Pin	<a href="#">PE1BT1000</a>	\$882.93		35
					Pin	<a href="#">PE1622</a>	\$1,407.21		36
	500 - 40,000			2.92mm	SMA	<a href="#">PE1BT1001</a>	Call		37
Solder Pin					<a href="#">PE1603</a>	\$326.30	38		



Technical Support  
+1 (949) 261-1920



Same-Day Shipping,  
Even Custom Cable Assemblies

Baluns

Bias Tees & DC Blocks

See Our Website For Current Pricing & Real-Time Stock Availability!

## DC Blocks



**Bias Tees & DC Blocks**

**See Our Website For Current Pricing & Real-Time Stock Availability!**

Impedance	Connector	Frequency Range (MHz.)	Type	Max. V (V)	Model No	1 Pc. Price	See Web for Volume Pricing			ROW
50 Ohm	1.85mm	10 - 65,000	Inner		<a href="#">PE8258</a>	\$689.00	See Web for Volume Pricing			39
			Inner		<a href="#">PE8237</a>	\$1,504.86				40
	2.4mm	100 - 50,000	Inner/Outer	75	<a href="#">PE8239</a>	\$1,799.00				41
			Outer		<a href="#">PE8238</a>	\$1,599.00				42
			Inner		<a href="#">PE8222</a>	\$302.25				43
	2.92mm	10 - 26,500	Inner/Outer	200	<a href="#">PE8224</a>	\$469.14				44
			Outer		<a href="#">PE8223</a>	\$358.25				45
			Inner		<a href="#">PE8225</a>	\$739.83				46
		10 - 40,000	Inner/Outer	200	<a href="#">PE8227</a>	\$1,235.03				47
			Outer		<a href="#">PE8226</a>	\$1,508.91				48
			Inner		<a href="#">PE8216</a>	\$195.18				49
	BNC	10 - 4,000	Inner/Outer		<a href="#">PE8218</a>	\$315.78				50
			Outer		<a href="#">PE8217</a>	\$270.66				51
			Inner		<a href="#">PE8213</a>	\$149.11				52
	N		Inner		<a href="#">PE8251</a>	\$199.24				53
			Inner/Outer		<a href="#">PE8215</a>	\$269.07				54
			Outer		<a href="#">PE8214</a>	\$241.94				55
			Inner		<a href="#">PE8210</a>	\$113.55				56
	SMA	10 - 18,000	Inner		<a href="#">PE8250</a>	\$149.08				57
			Inner/Outer		<a href="#">PE8212</a>	\$232.12				58
			Outer		<a href="#">PE8211</a>	\$212.29				59
	TNC		Inner	950	<a href="#">PE8219</a>	\$234.44				60
			Inner		<a href="#">PE8252</a>	\$301.85				61
			Inner/Outer		<a href="#">PE8221</a>	\$395.72				62
75 Ohm	BNC	100 - 4,000	Outer	200	<a href="#">PE8220</a>	\$330.07	63			
			Inner		<a href="#">PE8231</a>	\$308.67	64			
			Inner/Outer		<a href="#">PE8233</a>	\$374.91	65			
	F	10 - 2,000	Outer	200	<a href="#">PE8232</a>	\$185.63	66			
			Inner		<a href="#">PE8240</a>	\$128.41	67			
			Inner/Outer		<a href="#">PE8242</a>	\$252.98	68			
	N	100 - 4,000	Outer	200	<a href="#">PE8241</a>	\$198.36	69			
			Inner		<a href="#">PE8234</a>	\$264.48	70			
			Inner/Outer		<a href="#">PE8236</a>	\$259.45	71			



# The Cable Creator™

Configure and Customize Your  
Cable Assemblies Online

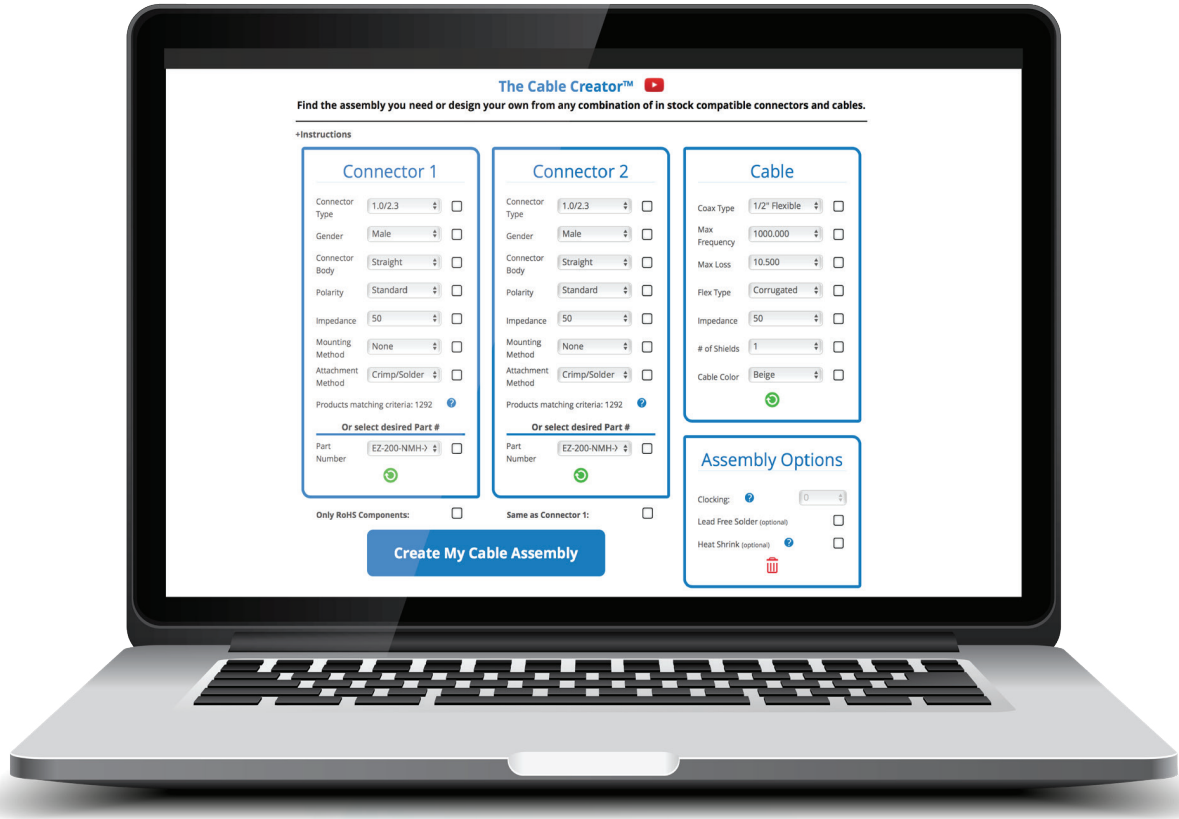

**Over 250,000 Custom Cable Configurations Available to Ship Same Day!**



- Choose from over 2,030 RF coax connectors
- 123 coaxial cable types, including Twinax
- Choose your desired length (metric or standard)
- Includes high-reliability and low PIM assembly types
- ISO 9001:2015 certified production facility
- Optional Customizations:
  - Lead-free solder
  - Heat shrink
  - Labeling
  - Test plots
  - Clocking of right angle connectors

# Our Latest Cable Assembly Additions

Available in Standard and Custom Lengths! In-Stock and Shipped Same Day



## High-Reliability Cable Assemblies

- MIL-DTL-17 and Temperature Conditioned, Low Loss Options
- Maximum Frequency Levels as High as 18 GHz
- J-STD Soldering Processes
- IPC/WHMA-A-620 Workmanship
- Lot Traceability for Cables, Connectors, Heat Shrink and Solder
- Detailed Test Reports and Plots

## Low PIM Cable Assemblies

- Maximum PIM Levels as Low as -160dBc
- 100% PIM Tested with Results Marked on the Cable
- Low Loss, Excellent VSWR
- Lightweight, Extremely Flexible
- UL-Rated, Fire-Rated, Outdoor-Rated Cable Types
- Available with 4.3-10, 7/16 DIN, 4.1/9.5 Mini-DIN, Type-N, NEX10, SMA, and QMA Connector Series



## 40 GHz and 67 GHz Skew Matched Cable Pairs

- 1 ps Delay Match
- Excellent VSWR of 1.4:1
- 100% Tested Up to 40 or 67 GHz
- Extremely Flexible
- Polarity Indicators on Cable Ends

## Handheld RF Analyzer Rugged Phase Stable Cable Assemblies

- VSWR as Low as 1.2:1
- Phase Stability with Flexure as Low as  $\pm 1.5$  Degrees
- Amplitude Stability with Flexure as Low as  $\pm 0.1$  dB
- Rugged Armor with 1200 PSI Crush Resistance, Protects Cable During Field Measurements
- UV Resistant Jacket
- Test Data Included with Each Serialized Cable



## PE-P160LL Low Loss Cable Assemblies

- Triple-Shielded Low Loss Cable
- Maximum Frequency Levels as High as 18 GHz
- Shielding Effectivity >90 dB
- FEP Jacket
- 83% Phase Velocity
- Available with Type-N, SMA, and TNC Connector Series with Bulkhead and Right Angle Options

# Coaxial Cable Assemblies Selection Guide

Do you need a cable assembly that isn't in our RF Product Guide?  
Visit our website to view our entire selection of available assemblies or  
to build your own custom length cable assembly!

## 3 Easy Ways to Find your Product.....

### 1. Search by PE Part Number

If you know the PE part number you are searching for, please reference our Part Number Index on Page [355](#)

### 2. Quick Reference Guide

(Page number refers to first appearance of product in the Cable Assemblies Section)

Cable Connector	Page	Cable Connector	Page	Cable Connector	Page	Cable Connector	Page	Cable Connector	Page
1.0/2.3	<a href="#">94</a>	75 Ohm 1.6/5.6	<a href="#">186</a>	C	<a href="#">112</a>	MMCX	<a href="#">118</a>	SMC	<a href="#">173</a>
1.0mm	<a href="#">94</a>	75 Ohm BNC	<a href="#">186</a>	FAKRA	<a href="#">113</a>	N	<a href="#">90</a>	SMP	<a href="#">174</a>
1.85mm	<a href="#">94</a>	75 Ohm F	<a href="#">187</a>	FME	<a href="#">114</a>	NMO Mount	<a href="#">137</a>	SSMA	<a href="#">175</a>
10-32	<a href="#">101</a>	75 Ohm Mini SMB	<a href="#">187</a>	GR874	<a href="#">115</a>	QMA	<a href="#">93</a>	SSMB	<a href="#">176</a>
2.4mm	<a href="#">94</a>	75 Ohm N	<a href="#">188</a>	HMCX32 1.2	<a href="#">184</a>	QN	<a href="#">138</a>	SSMC	<a href="#">176</a>
2.92mm	<a href="#">95</a>	75 Ohm SMB	<a href="#">189</a>	HN	<a href="#">115</a>	Reverse Polarity SMA	<a href="#">156</a>	TNC	<a href="#">91</a>
2.92mm NMD	<a href="#">185</a>	75 Ohm SMC	<a href="#">189</a>	LC	<a href="#">115</a>	Reverse Polarity TNC	<a href="#">180</a>	UHF	<a href="#">183</a>
3.5mm	<a href="#">96</a>	75 Ohm TNC	<a href="#">189</a>	MC-Card	<a href="#">116</a>	Reverse Thread SMA	<a href="#">157</a>	UMCX	<a href="#">184</a>
3.5mm NMD	<a href="#">97</a>	78 Ohm BNC Twinax	<a href="#">189</a>	MCX	<a href="#">116</a>	SC	<a href="#">138</a>	UMCX 2.1	<a href="#">184</a>
4.1/9.5 Mini DIN	<a href="#">93</a>	95 Ohm 3/4"-20 Twinax	<a href="#">189</a>	MHV	<a href="#">117</a>	SHV	<a href="#">139</a>	UMCX 2.5	<a href="#">184</a>
4.3-10	<a href="#">93</a>	BMA	<a href="#">102</a>	Mini UHF	<a href="#">118</a>	SMA	<a href="#">91</a>	WMCX 1.6	<a href="#">184</a>
7/16 DIN	<a href="#">93</a>	BNC	<a href="#">90</a>	MMBX	<a href="#">119</a>	SMB	<a href="#">171</a>		

Cable Assemblies

### 3. Cable Assembly Locator

(Cable Assembly Locator on Page [86-89](#) to locate the Cable Assembly you need by either connector end.)



SMA Female Bulkhead to MCX Plug Right Angle  
PE39421-12

SMA FEMALE BULKHEAD TO:	EXAMPLE
MCX PLUG RIGHT ANGLE.....	<a href="#">23</a>
MMCX PLUG RIGHT ANGLE.....	23
SMA FEMALE BULKHEAD.....	43
SMA MALE.....	17,23,31,32
SMA MALE RIGHT ANGLE.....	17,23,40,41
UMCX PLUG.....	76

MCX PLUG RIGHT ANGLE TO:	EXAMPLE
MCX PLUG.....	78
MCX PLUG RIGHT ANGLE.....	79
N FEMALE BULKHEAD.....	25
SMA FEMALE BULKHEAD.....	<a href="#">23</a>
TNC FEMALE BULKHEAD.....	27
UMCX PLUG.....	76

The Cable Assembly Locator example above includes Between-Series Cable Assembly part numbers in two configurations: **Connector 1 to Connector 2 as well as Connector 2 to Connector 1 will be found in the same location.**

Products can only be found under the first instance of the series combination. As an example, PE39421-12 above will be found in only one location in the Cable Assembly Section.

All Pasternack coaxial cable assembly part number indicate the length of the assembly (in inches) following the hyphen. Example: PE300-24 and PE300-26.5 are 24 inches and 26.5 inches in length respectively

**NOTE: All cable assemblies have a length tolerance of 1.5% or ± 3/8", whichever is greater.**

# Cable Assembly Locator

Connector Type	Page
<b>1.0/2.3 Jack Bulkhead To:</b>	
1.0/2.3 JACK BULKHEAD	<a href="#">94</a>
<b>1.0/2.3 Plug To:</b>	
BNC FEMALE BULKHEAD	<a href="#">94</a>
<b>1.0/2.3 Plug Right Angle To:</b>	
BNC MALE	<a href="#">94</a>
<b>1.0mm Male To:</b>	
1.0mm MALE	<a href="#">94</a>
<b>1.85mm Male To:</b>	
1.85mm FEMALE	<a href="#">94</a>
1.85mm MALE	<a href="#">94</a>
1.85mm MALE RIGHT ANGLE	<a href="#">94</a>
<b>2.4mm Female To:</b>	
2.4mm FEMALE	<a href="#">95</a>
<b>2.4mm Female Bulkhead To:</b>	
SMA MALE	<a href="#">95</a>
<b>2.4mm Male To:</b>	
1.85mm MALE	<a href="#">94</a>
2.4mm FEMALE	<a href="#">95</a>
2.4mm MALE	<a href="#">94</a>
2.4mm MALE RIGHT ANGLE	<a href="#">95</a>
2.92mm MALE	<a href="#">95</a>
SMA MALE	<a href="#">95</a>
SMA MALE RIGHT ANGLE	<a href="#">95</a>
<b>2.92mm Male To:</b>	
2.4mm MALE	<a href="#">95</a>
2.92mm FEMALE	<a href="#">96</a>
2.92mm FEMALE BULKHEAD	<a href="#">96</a>
2.92mm MALE	<a href="#">95</a>
2.92mm MALE	<a href="#">96</a>
<b>2.92mm NMD Female To:</b>	
2.92mm FEMALE	<a href="#">185</a>
2.92mm MALE	<a href="#">185</a>
<b>3.5mm Female To:</b>	
3.5mm FEMALE	<a href="#">96</a>
3.5mm NMD FEMALE	<a href="#">97</a>
<b>3.5mm Male To:</b>	
3.5mm FEMALE	<a href="#">96</a>
3.5mm FEMALE BULKHEAD	<a href="#">96</a>
3.5mm MALE	<a href="#">96</a>
<b>3.5mm NMD Female To:</b>	
3.5mm MALE	<a href="#">97</a>
<b>4.1/9.5 Mini DIN Female To:</b>	
4.3-10 MALE	<a href="#">93</a>
7/16 DIN MALE	<a href="#">93</a>
N MALE	<a href="#">93</a>
QMA MALE	<a href="#">93</a>
SMA MALE	<a href="#">93</a>
4.3-10 MALE	<a href="#">98</a>
7/16 DIN MALE	<a href="#">98</a>
N MALE	<a href="#">98</a>
QMA MALE	<a href="#">98</a>
SMA MALE	<a href="#">98</a>
<b>4.1/9.5 Mini DIN Male To:</b>	
4.1/9.5 MINI DIN FEMALE	<a href="#">93</a>
4.1/9.5 MINI DIN MALE	<a href="#">93</a>
4.1/9.5 MINI DIN MALE RIGHT ANGLE	<a href="#">93</a>
4.3-10 FEMALE	<a href="#">93</a>
7/16 DIN FEMALE	<a href="#">93</a>
7/16 DIN MALE	<a href="#">93</a>
N FEMALE	<a href="#">93</a>
QMA FEMALE	<a href="#">93</a>
QMA MALE	<a href="#">93</a>
QMA MALE RIGHT ANGLE	<a href="#">93</a>
SMA FEMALE	<a href="#">93</a>
SMA MALE	<a href="#">93</a>
SMA MALE RIGHT ANGLE	<a href="#">93</a>
4.1/9.5 MINI DIN FEMALE	<a href="#">97</a>
4.1/9.5 MINI DIN MALE	<a href="#">97</a>
4.1/9.5 MINI DIN MALE RIGHT ANGLE	<a href="#">97</a>
4.3-10 FEMALE	<a href="#">97</a>
7/16 DIN FEMALE	<a href="#">97</a>
7/16 DIN MALE	<a href="#">97</a>
QMA FEMALE	<a href="#">97</a>
QMA MALE	<a href="#">97</a>
QMA MALE RIGHT ANGLE	<a href="#">97</a>
SMA FEMALE	<a href="#">97</a>
SMA MALE	<a href="#">97</a>

Connector Type	Page
SMA MALE	<a href="#">97</a>
SMA MALE RIGHT ANGLE	<a href="#">97</a>
<b>4.1/9.5 Mini DIN Male Right Angle To:</b>	
4.1/9.5 MINI DIN MALE RIGHT ANGLE	<a href="#">93</a>
4.3-10 FEMALE	<a href="#">93</a>
4.3-10 MALE	<a href="#">93</a>
7/16 DIN MALE	<a href="#">93</a>
N MALE	<a href="#">93</a>
QMA MALE	<a href="#">93</a>
SMA MALE	<a href="#">93</a>
4.1/9.5 MINI DIN MALE RIGHT ANGLE	<a href="#">98</a>
4.3-10 FEMALE	<a href="#">98</a>
4.3-10 MALE	<a href="#">98</a>
7/16 DIN MALE	<a href="#">98</a>
N MALE	<a href="#">98</a>
QMA MALE	<a href="#">98</a>
SMA MALE	<a href="#">98</a>
<b>4.3-10 Female To:</b>	
7/16 DIN MALE	<a href="#">93</a>
N MALE	<a href="#">93</a>
QMA MALE	<a href="#">93</a>
SMA MALE	<a href="#">93</a>
N MALE	<a href="#">99</a>
QMA MALE	<a href="#">99</a>
SMA MALE	<a href="#">99</a>
<b>4.3-10 Male To:</b>	
4.3-10 FEMALE	<a href="#">93</a>
4.3-10 MALE	<a href="#">93</a>
7/16 DIN FEMALE	<a href="#">93</a>
7/16 DIN MALE	<a href="#">93</a>
QMA FEMALE	<a href="#">93</a>
QMA MALE	<a href="#">93</a>
QMA MALE RIGHT ANGLE	<a href="#">93</a>
SMA FEMALE	<a href="#">93</a>
SMA MALE	<a href="#">93</a>
SMA MALE RIGHT ANGLE	<a href="#">93</a>
4.3-10 FEMALE	<a href="#">98</a>
4.3-10 MALE	<a href="#">98</a>
7/16 DIN FEMALE	<a href="#">98</a>
7/16 DIN MALE	<a href="#">98</a>
N MALE	<a href="#">99</a>
QMA FEMALE	<a href="#">99</a>
QMA MALE	<a href="#">99</a>
QMA MALE RIGHT ANGLE	<a href="#">99</a>
SMA FEMALE	<a href="#">99</a>
SMA MALE	<a href="#">99</a>
SMA MALE RIGHT ANGLE	<a href="#">99</a>
<b>4.3-10 Male Right Angle To:</b>	
4.3-10 MALE	<a href="#">93</a>
4.3-10 MALE RIGHT ANGLE	<a href="#">93</a>
4.3-10 MALE	<a href="#">99</a>
4.3-10 MALE RIGHT ANGLE	<a href="#">99</a>
<b>7/16 DIN Female To:</b>	
N MALE	<a href="#">93</a>
QMA MALE	<a href="#">93</a>
SMA MALE	<a href="#">93</a>
N MALE	<a href="#">101</a>
QMA MALE	<a href="#">101</a>
SMA MALE	<a href="#">101</a>
<b>7/16 DIN Male To:</b>	
7/16 DIN FEMALE	<a href="#">93</a>
7/16 DIN MALE	<a href="#">93</a>
QMA FEMALE	<a href="#">93</a>
QMA MALE	<a href="#">93</a>
QMA MALE RIGHT ANGLE	<a href="#">93</a>
SMA FEMALE	<a href="#">93</a>
SMA MALE	<a href="#">93</a>
SMA MALE RIGHT ANGLE	<a href="#">93</a>
4.3-10 FEMALE	<a href="#">99</a>
7/16 DIN FEMALE	<a href="#">100</a>
7/16 DIN MALE	<a href="#">99</a>
7/16 DIN MALE	<a href="#">100</a>
7/16 DIN MALE RIGHT ANGLE	<a href="#">100</a>
N MALE	<a href="#">100</a>
QMA FEMALE	<a href="#">100</a>
QMA MALE	<a href="#">100</a>
QMA MALE RIGHT ANGLE	<a href="#">100</a>
SC MALE	<a href="#">101</a>
SMA FEMALE	<a href="#">101</a>
SMA MALE	<a href="#">101</a>
SMA MALE RIGHT ANGLE	<a href="#">101</a>

Connector Type	Page
<b>7/16 DIN Male Right Angle To:</b>	
7/16 DIN MALE	<a href="#">93</a>
7/16 DIN MALE RIGHT ANGLE	<a href="#">93</a>
7/16 DIN MALE	<a href="#">101</a>
7/16 DIN MALE RIGHT ANGLE	<a href="#">101</a>
<b>10-32 Female To:</b>	
BNC MALE	<a href="#">102</a>
<b>10-32 Male To:</b>	
10-32 MALE	<a href="#">101</a>
10-32 MALE RIGHT ANGLE	<a href="#">101</a>
BNC MALE	<a href="#">101</a>
<b>10-32 Male Right Angle To:</b>	
10-32 MALE RIGHT ANGLE	<a href="#">101</a>
10-32 MALE RIGHT ANGLE	<a href="#">102</a>
<b>75 Ohm 1.6/5.6 Plug To:</b>	
75 Ohm 1.6/5.6 PLUG	<a href="#">186</a>
75 Ohm BNC MALE	<a href="#">186</a>
<b>75 Ohm BNC Female To:</b>	
75 Ohm BNC FEMALE	<a href="#">187</a>
<b>75 Ohm BNC Female Bulkhead To:</b>	
75 Ohm BNC FEMALE BULKHEAD	<a href="#">187</a>
<b>75 Ohm BNC Male To:</b>	
75 Ohm BNC FEMALE	<a href="#">186</a>
75 Ohm BNC FEMALE BULKHEAD	<a href="#">186</a>
75 Ohm BNC MALE	<a href="#">186</a>
75 Ohm BNC MALE RIGHT ANGLE	<a href="#">186</a>
<b>75 Ohm BNC Male Right Angle To:</b>	
75 Ohm BNC MALE RIGHT ANGLE	<a href="#">186</a>
<b>75 Ohm F Male To:</b>	
75 Ohm BNC MALE	<a href="#">187</a>
75 Ohm F FEMALE	<a href="#">187</a>
75 Ohm F FEMALE BULKHEAD	<a href="#">187</a>
75 Ohm F MALE	<a href="#">187</a>
75 Ohm F MALE RIGHT ANGLE	<a href="#">187</a>
<b>75 Ohm Mini SMB Plug To:</b>	
75 Ohm BNC MALE	<a href="#">187</a>
75 Ohm MINI SMB PLUG	<a href="#">188</a>
75 Ohm MINI SMB PLUG RIGHT ANGLE	<a href="#">188</a>
<b>75 Ohm Mini SMB Plug Right Angle To:</b>	
75 Ohm F FEMALE BULKHEAD	<a href="#">188</a>
75 Ohm MINI SMB PLUG RIGHT ANGLE	<a href="#">188</a>
<b>75 Ohm N Female To:</b>	
75 Ohm N FEMALE	<a href="#">189</a>
<b>75 Ohm N Male To:</b>	
75 Ohm BNC MALE	<a href="#">188</a>
75 Ohm F FEMALE	<a href="#">188</a>
75 Ohm F MALE	<a href="#">188</a>
75 Ohm N FEMALE	<a href="#">188</a>
75 Ohm N MALE	<a href="#">188</a>
<b>75 Ohm SMB Plug To:</b>	
75 Ohm BNC MALE	<a href="#">189</a>
75 Ohm SMB PLUG	<a href="#">189</a>
<b>75 Ohm SMC Plug To:</b>	
75 Ohm BNC MALE	<a href="#">189</a>
75 Ohm SMC PLUG	<a href="#">189</a>
<b>75 Ohm TNC Male To:</b>	
75 Ohm BNC MALE	<a href="#">189</a>
75 Ohm TNC MALE	<a href="#">189</a>
<b>78 Ohm BNC Twinax Plug To:</b>	
78 Ohm BNC TWINAX PLUG	<a href="#">189</a>
<b>95 Ohm 3/4"-20 Twinax Male To:</b>	
95 Ohm 3/4"-20 TWINAX MALE	<a href="#">189</a>
<b>BMA Jack To:</b>	
BMA JACK	<a href="#">104</a>
BNC MALE	<a href="#">104</a>
N MALE	<a href="#">104</a>
SMA MALE	<a href="#">105</a>
SMA MALE RIGHT ANGLE	<a href="#">105</a>
SMP FEMALE	<a href="#">105</a>
SMP FEMALE RIGHT ANGLE	<a href="#">105</a>
TNC MALE	<a href="#">105</a>
<b>BMA Jack 2 Hole Flange To:</b>	
BMA JACK 2 HOLE FLANGE	<a href="#">106</a>
BNC MALE	<a href="#">106</a>

# Cable Assembly Locator

Connector Type	Page
<b>BMA Jack 2 Hole Flange To:</b>	
N MALE.....	106
SMA MALE.....	106
SMA MALE RIGHT ANGLE.....	106
SMP FEMALE.....	106
SMP FEMALE RIGHT ANGLE.....	106
TNC MALE.....	106
<b>BMA Jack Bulkhead To:</b>	
BMA JACK BULKHEAD.....	105
<b>BMA Jack Right Angle 2 Hole Flange To:</b>	
BMA JACK RIGHT ANGLE 2 HOLE FLANGE.....	107
<b>BMA Plug Bulkhead To:</b>	
BMA JACK.....	102
BMA JACK 2 HOLE FLANGE.....	102
BMA JACK BULKHEAD.....	102
BMA JACK RIGHT ANGLE 2 HOLE FLANGE.....	102
BMA PLUG BULKHEAD.....	102
BNC MALE.....	103
N MALE.....	103
SMA MALE.....	103
SMA MALE RIGHT ANGLE.....	103
SMP FEMALE.....	103
SMP FEMALE RIGHT ANGLE.....	104
TNC MALE.....	104
<b>BNC Female To:</b>	
BNC FEMALE.....	112
BNC MALE RIGHT ANGLE.....	112
NMO Mount Sexless.....	185
SMA MALE.....	112
<b>BNC Female Bulkhead To:</b>	
SMA MALE.....	112
<b>BNC Male To:</b>	
BNC MALE.....	90
N FEMALE.....	90
N MALE.....	90
SMA FEMALE.....	90
SMA MALE.....	90
SMA MALE RIGHT ANGLE.....	90
TNC MALE.....	90
BNC FEMALE.....	110
BNC FEMALE BULKHEAD.....	110
BNC MALE.....	107
BNC MALE.....	108
BNC MALE.....	109
BNC MALE RIGHT ANGLE.....	109
BNC MALE RIGHT ANGLE.....	110
Cut Lead Sexless.....	185
MHV MALE.....	111
N FEMALE.....	107
N FEMALE BULKHEAD.....	107
N MALE.....	107
N MALE.....	111
NMO Mount Sexless.....	185
SHV PLUG.....	111
SMA FEMALE BULKHEAD.....	108
SMA MALE.....	107
SMA MALE.....	111
SMA MALE RIGHT ANGLE.....	108
SSMC PLUG.....	111
SSMC PLUG RIGHT ANGLE.....	111
TNC MALE.....	108
<b>BNC Male Right Angle To:</b>	
BNC FEMALE BULKHEAD.....	112
BNC MALE RIGHT ANGLE.....	111
BNC MALE RIGHT ANGLE.....	112
SMA FEMALE.....	112
TNC MALE RIGHT ANGLE.....	112
<b>C Male To:</b>	
C MALE.....	112
C MALE.....	113
<b>C Male Right Angle To:</b>	
C MALE.....	113
<b>FAKRA Jack To:</b>	
FAKRA JACK.....	114
FAKRA JACK RIGHT ANGLE.....	114
REVERSE POLARITY TNC MALE.....	114
SMA FEMALE.....	114
<b>FAKRA Jack Right Angle To:</b>	
FAKRA PLUG.....	114

Connector Type	Page
<b>FAKRA Plug To:</b>	
FAKRA JACK.....	113
FAKRA JACK RIGHT ANGLE.....	113
FAKRA JACK RIGHT ANGLE.....	114
FAKRA PLUG.....	113
<b>FME Jack To:</b>	
BNC MALE.....	115
FME JACK.....	115
<b>FME Plug To:</b>	
BNC MALE.....	114
<b>FME Plug Bulkhead To:</b>	
UMCX PLUG RIGHT ANGLE.....	115
<b>GR874 Sexless To:</b>	
BNC MALE.....	115
GR874 Sexless.....	115
<b>HMCX32 1.2 Plug To:</b>	
HMCX32 1.2 PLUG.....	184
<b>HN Male To:</b>	
7/16 DIN MALE RIGHT ANGLE.....	115
HN MALE.....	115
<b>HN Male Right Angle To:</b>	
HN FEMALE.....	115
<b>LC Male To:</b>	
LC MALE.....	115
LC MALE.....	116
<b>LC Male Right Angle To:</b>	
HN MALE.....	116
<b>MC-Card Plug To:</b>	
MC-Card PLUG.....	116
<b>MCX Jack To:</b>	
MCX JACK.....	117
<b>MCX Plug To:</b>	
75 Ohm BNC MALE.....	185
BNC MALE.....	116
MCX PLUG.....	116
MCX PLUG RIGHT ANGLE.....	116
SMA MALE.....	116
TNC FEMALE BULKHEAD.....	116
<b>MCX Plug Right Angle To:</b>	
BNC FEMALE 4 HOLE FLANGE.....	116
MCX JACK BULKHEAD.....	117
MCX PLUG RIGHT ANGLE.....	116
SMA MALE.....	117
<b>MHV Male To:</b>	
MHV MALE.....	117
MHV MALE RIGHT ANGLE.....	117
SHV PLUG.....	117
SHV PLUG.....	118
<b>Mini UHF Male To:</b>	
MINI UHF MALE.....	118
NMO Mount Sexless.....	185
<b>MMBX Plug To:</b>	
MMBX PLUG.....	119
MMBX PLUG RIGHT ANGLE.....	119
SMA FEMALE.....	119
SMA FEMALE BULKHEAD.....	119
SMA MALE.....	119
SMA MALE RIGHT ANGLE.....	119
SSMB JACK BULKHEAD.....	119
TNC FEMALE BULKHEAD.....	119
<b>MMBX Plug Right Angle To:</b>	
MMBX PLUG RIGHT ANGLE.....	119
REVERSE POLARITY SMA FEMALE BULKHEAD.....	120
SMA FEMALE.....	120
SMA FEMALE BULKHEAD.....	120
SMA MALE.....	120
SMA MALE RIGHT ANGLE.....	120
TNC FEMALE BULKHEAD.....	120
<b>MMCX Plug To:</b>	
MMCX PLUG.....	118
MMCX PLUG RIGHT ANGLE.....	118
N FEMALE BULKHEAD.....	118
SMC PLUG.....	118
<b>MMCX Plug Right Angle To:</b>	
BNC FEMALE BULKHEAD.....	118

Connector Type	Page
MMCX PLUG.....	118
SMA FEMALE.....	119
SMA MALE RIGHT ANGLE.....	118
<b>N Female To:</b>	
7/16 DIN MALE.....	93
N FEMALE.....	90
N FEMALE.....	91
N FEMALE.....	93
N MALE.....	93
N MALE RIGHT ANGLE.....	91
SMA MALE.....	90
SMA MALE.....	91
SMA MALE RIGHT ANGLE.....	90
SMA MALE RIGHT ANGLE.....	91
TNC MALE.....	90
TNC MALE.....	91
7/16 DIN MALE.....	135
N FEMALE.....	134
N FEMALE.....	135
N FEMALE BULKHEAD.....	134
N FEMALE BULKHEAD.....	135
NMO Mount Sexless.....	185
QN MALE RIGHT ANGLE.....	135
SMA MALE.....	134
SMA MALE RIGHT ANGLE.....	134
SMA MALE RIGHT ANGLE.....	135
TNC MALE.....	135
<b>N Female 4 Hole Flange To:</b>	
MMCX PLUG RIGHT ANGLE.....	137
<b>N Female Bulkhead To:</b>	
BNC MALE.....	136
HMCX32 1.2 PLUG.....	137
MCX PLUG RIGHT ANGLE.....	136
MMCX PLUG RIGHT ANGLE.....	136
N FEMALE BULKHEAD.....	135
N FEMALE BULKHEAD.....	136
N MALE.....	136
N MALE RIGHT ANGLE.....	136
QMA MALE RIGHT ANGLE.....	136
REVERSE POLARITY SMA MALE RIGHT ANGLE.....	137
SMA FEMALE.....	136
SMA FEMALE BULKHEAD.....	137
SMA MALE.....	135
SMA MALE.....	136
SMA MALE RIGHT ANGLE.....	135
SMA MALE RIGHT ANGLE.....	136
SMP FEMALE RIGHT ANGLE.....	137
TNC FEMALE BULKHEAD.....	137
TNC MALE.....	136
TNC MALE.....	137
TNC MALE RIGHT ANGLE.....	137
UMCX 2.1 PLUG.....	137
UMCX 2.5 PLUG.....	137
<b>N Male To:</b>	
4.1/9.5 MINI DIN MALE.....	93
4.3-10 MALE.....	93
7/16 DIN FEMALE.....	93
7/16 DIN MALE.....	93
7/16 DIN MALE RIGHT ANGLE.....	93
N FEMALE.....	90
N FEMALE.....	91
N FEMALE.....	93
N MALE.....	90
N MALE.....	91
N MALE.....	93
N MALE RIGHT ANGLE.....	91
QMA FEMALE.....	93
QMA MALE.....	93
QMA MALE RIGHT ANGLE.....	93
SMA FEMALE.....	93
SMA MALE.....	90
SMA MALE.....	93
SMA MALE RIGHT ANGLE.....	90
SMA MALE RIGHT ANGLE.....	93
TNC MALE.....	90
4.1/9.5 MINI DIN MALE.....	121
7/16 DIN FEMALE.....	122
7/16 DIN MALE.....	121
7/16 DIN MALE.....	122
7/16 DIN MALE RIGHT ANGLE.....	122
BNC FEMALE BULKHEAD.....	123
BNC MALE.....	122
C FEMALE.....	123



# Cable Assembly Locator

Connector Type	Page
<b>N Male To:</b>	
MINI UHF MALE	123
N FEMALE	121
N FEMALE	126
N FEMALE	127
N FEMALE 4 HOLE FLANGE	128
N FEMALE BULKHEAD	121
N FEMALE BULKHEAD	127
N FEMALE BULKHEAD	128
N MALE	120
N MALE	123
N MALE	124
N MALE	125
N MALE RIGHT ANGLE	125
N MALE RIGHT ANGLE	126
NMO Mount Sexless	185
QMA FEMALE	129
QMA MALE	128
QMA MALE RIGHT ANGLE	128
QMA MALE RIGHT ANGLE	129
QN MALE	129
QN MALE RIGHT ANGLE	129
REVERSE POLARITY TNC MALE	131
REVERSE POLARITY TNC MALE	132
REVERSE POLARITY TNC MALE RIGHT ANGLE	132
SHV PLUG	129
SMA FEMALE	130
SMA FEMALE BULKHEAD	130
SMA MALE	121
SMA MALE	129
SMA MALE RIGHT ANGLE	121
SMA MALE RIGHT ANGLE	129
SMA MALE RIGHT ANGLE	130
SSMC JACK BULKHEAD	130
SSMC PLUG	130
SSMC PLUG RIGHT ANGLE	130
TNC FEMALE	131
TNC FEMALE BULKHEAD	131
TNC MALE	121
TNC MALE	130
TNC MALE	131
TNC MALE RIGHT ANGLE	131
UMCX PLUG RIGHT ANGLE	132
<b>N Male Right Angle To:</b>	
N MALE	93
N MALE RIGHT ANGLE	91
N MALE RIGHT ANGLE	93
BNC MALE	132
N FEMALE	133
N FEMALE BULKHEAD	133
N MALE	132
N MALE RIGHT ANGLE	132
N MALE RIGHT ANGLE	133
SMA FEMALE BULKHEAD	134
SMA MALE	133
SMA MALE RIGHT ANGLE	133
TNC FEMALE BULKHEAD	134
TNC MALE	134
TNC MALE RIGHT ANGLE	134
UHF MALE	134
<b>NMO Mount Sexless To:</b>	
TNC MALE	137
<b>QMA Female To:</b>	
SMA MALE	93
SMA MALE	138
<b>QMA Male To:</b>	
QMA FEMALE	93
QMA MALE	93
QMA MALE RIGHT ANGLE	93
SMA FEMALE	93
SMA MALE	93
SMA MALE RIGHT ANGLE	93
QMA FEMALE	138
QMA MALE	137
QMA MALE	138
QMA MALE RIGHT ANGLE	138
SMA FEMALE	138
SMA MALE	138
SMA MALE RIGHT ANGLE	138
<b>QMA Male Right Angle To:</b>	
QMA MALE RIGHT ANGLE	93
SMA MALE	93

Connector Type	Page
QMA MALE RIGHT ANGLE	138
SMA MALE	138
<b>QN Male To:</b>	
QN MALE	138
QN MALE RIGHT ANGLE	138
<b>QN Male Right Angle To:</b>	
N FEMALE	138
<b>Reverse Polarity SMA Female Bulkhead To:</b>	
HMCX32 1.2 PLUG	170
SMA MALE	169
SMA MALE RIGHT ANGLE	169
UMCX 2.1 PLUG	170
UMCX 2.5 PLUG	170
UMCX PLUG RIGHT ANGLE	170
WMCX 1.6 PLUG	170
<b>Reverse Polarity SMA Male To:</b>	
BNC MALE	156
MCX PLUG RIGHT ANGLE	156
N FEMALE BULKHEAD	157
N MALE	156
N MALE	157
REVERSE POLARITY SMA MALE	157
TNC MALE	157
<b>Reverse Polarity SMA Male Right Angle To:</b>	
N MALE	163
N MALE RIGHT ANGLE	163
SMA MALE	163
<b>Reverse Polarity TNC Female To:</b>	
REVERSE POLARITY SMA MALE	182
<b>Reverse Polarity TNC Female Bulkhead To:</b>	
MMCX PLUG	183
REVERSE POLARITY TNC MALE	183
SSMC PLUG RIGHT ANGLE	183
UMCX PLUG	183
<b>Reverse Polarity TNC Male To:</b>	
BNC MALE	180
<b>Reverse Thread SMA Male To:</b>	
Reverse Thread SMA MALE	157
<b>SC Male To:</b>	
SC MALE	138
SC MALE	139
<b>SHV Jack Bulkhead To:</b>	
SHV PLUG	139
<b>SHV Plug To:</b>	
SHV JACK BULKHEAD	139
SHV PLUG	139
<b>SMA Female To:</b>	
N FEMALE	91
N FEMALE	92
N MALE	91
N MALE	92
N MALE RIGHT ANGLE	91
N MALE RIGHT ANGLE	92
SMA FEMALE	91
SMA FEMALE	92
SMA MALE RIGHT ANGLE	91
SMA MALE RIGHT ANGLE	92
TNC FEMALE	91
TNC FEMALE	92
TNC MALE	91
TNC MALE	92
TNC MALE RIGHT ANGLE	91
TNC MALE RIGHT ANGLE	92
1.85mm MALE	140
7/16 DIN MALE	140
BNC MALE	140
BNC MALE	141
BNC MALE RIGHT ANGLE	141
FAKRA JACK	141
FAKRA JACK	142
FAKRA PLUG	141
HMCX32 1.2 PLUG	156
MC-Card PLUG	142
MINI UHF MALE	142
MMCX PLUG	142
MMCX PLUG RIGHT ANGLE	142
N FEMALE	144
N FEMALE BULKHEAD	144
N FEMALE BULKHEAD	145

Connector Type	Page
SSMC PLUG	166
SSMC PLUG RIGHT ANGLE	166
TNC FEMALE BULKHEAD	166
TNC MALE	166
TNC MALE RIGHT ANGLE	166
Trimmed Lead Sexless	185
<b>SMA Female 2 Hole Flange To:</b>	
SMA FEMALE 2 HOLE FLANGE	170
SMP FEMALE	170
SMP FEMALE RIGHT ANGLE	170
<b>SMA Female 4 Hole Flange To:</b>	
MMCX PLUG RIGHT ANGLE	170
SMA FEMALE 4 HOLE FLANGE	170
SMA FEMALE 4 HOLE FLANGE	171
<b>SMA Female Bulkhead To:</b>	
HMCX32 1.2 PLUG	169
MCX PLUG RIGHT ANGLE	166
MMCX PLUG	166
MMCX PLUG RIGHT ANGLE	167
N FEMALE BULKHEAD	167
N MALE	167
N MALE RIGHT ANGLE	167
REVERSE POLARITY SMA MALE	168
SMA FEMALE	167
SMA FEMALE BULKHEAD	166
SMA FEMALE BULKHEAD	167
SMA FEMALE BULKHEAD	168
SMA MALE	167
SMA MALE RIGHT ANGLE	167
SMB PLUG RIGHT ANGLE	168
SMP FEMALE	168
SMP FEMALE RIGHT ANGLE	168
SSMC PLUG	168
SSMC PLUG RIGHT ANGLE	168
SSMC PLUG RIGHT ANGLE	169
TNC FEMALE BULKHEAD	169
TNC MALE	166
TNC MALE	169
TNC MALE RIGHT ANGLE	169
UMCX 2.1 PLUG	169
UMCX 2.5 PLUG	169
UMCX PLUG RIGHT ANGLE	169
WMCX 1.6 PLUG	169
<b>SMA Male To:</b>	
7/16 DIN MALE	93
N FEMALE	91
N FEMALE	92
N MALE	91
N MALE	92
N MALE RIGHT ANGLE	91
N MALE RIGHT ANGLE	92
SMA FEMALE	91
SMA FEMALE	92
SMA FEMALE	93
SMA MALE	91
SMA MALE	92
SMA MALE	93
SMA MALE RIGHT ANGLE	91
SMA MALE RIGHT ANGLE	92
SMA MALE RIGHT ANGLE	93
TNC FEMALE	91
TNC FEMALE	92
TNC MALE	91
TNC MALE	92
TNC MALE RIGHT ANGLE	91
TNC MALE RIGHT ANGLE	92
1.85mm MALE	140
7/16 DIN MALE	140
BNC MALE	140
BNC MALE	141
BNC MALE RIGHT ANGLE	141
FAKRA JACK	141
FAKRA JACK	142
FAKRA PLUG	141
HMCX32 1.2 PLUG	156
MC-Card PLUG	142
MINI UHF MALE	142
MMCX PLUG	142
MMCX PLUG RIGHT ANGLE	142
N FEMALE	144
N FEMALE BULKHEAD	144
N FEMALE BULKHEAD	145

# Cable Assembly Locator

Connector Type	Page
<b>SMA Male To:</b>	
N MALE.....	142
N MALE.....	143
N MALE.....	144
N MALE RIGHT ANGLE.....	144
NMO Mount Sexless.....	185
QMA MALE.....	145
REVERSE POLARITY SMA MALE.....	151
REVERSE POLARITY TNC MALE.....	155
REVERSE POLARITY TNC MALE.....	156
Reverse Thread SMA MALE.....	152
SMA FEMALE.....	149
SMA FEMALE.....	150
SMA FEMALE BULKHEAD.....	140
SMA FEMALE BULKHEAD.....	150
SMA FEMALE BULKHEAD.....	151
SMA MALE.....	139
SMA MALE.....	145
SMA MALE.....	146
SMA MALE.....	147
SMA MALE RIGHT ANGLE.....	140
SMA MALE RIGHT ANGLE.....	147
SMA MALE RIGHT ANGLE.....	148
SMA MALE RIGHT ANGLE.....	149
SMB JACK.....	152
SMB PLUG.....	152
SMB PLUG RIGHT ANGLE.....	152
SMC PLUG.....	152
SMC PLUG.....	153
SMP FEMALE.....	153
SMP FEMALE RIGHT ANGLE.....	153
SSMA MALE.....	153
SSMC JACK.....	154
SSMC JACK BULKHEAD.....	154
SSMC PLUG.....	153
SSMC PLUG RIGHT ANGLE.....	153
TNC FEMALE.....	155
TNC FEMALE BULKHEAD.....	155
TNC MALE.....	140
TNC MALE.....	154
TNC MALE.....	155
TNC MALE RIGHT ANGLE.....	155
UMCX 2.1 PLUG.....	156
UMCX 2.5 PLUG.....	156
UMCX PLUG.....	156
WMCX 1.6 PLUG.....	156
<b>SMA Male Right Angle To:</b>	
N FEMALE.....	91
N FEMALE.....	92
N MALE.....	91
N MALE.....	92
N MALE RIGHT ANGLE.....	91
N MALE RIGHT ANGLE.....	92
SMA FEMALE.....	91
SMA MALE RIGHT ANGLE.....	91
SMA MALE RIGHT ANGLE.....	92
SMA MALE RIGHT ANGLE.....	93
TNC FEMALE.....	91
TNC FEMALE.....	92
TNC MALE.....	91
TNC MALE.....	92
TNC MALE RIGHT ANGLE.....	91
TNC MALE RIGHT ANGLE.....	92
BNC FEMALE BULKHEAD.....	158
BNC MALE.....	158
MCX JACK.....	158
MCX PLUG RIGHT ANGLE.....	158
MMCX PLUG RIGHT ANGLE.....	158
N FEMALE BULKHEAD.....	159
N MALE.....	158
N MALE.....	159
N MALE RIGHT ANGLE.....	159
REVERSE POLARITY SMA FEMALE.....	162
REVERSE POLARITY SMA MALE RIGHT ANGLE.....	162
SMA FEMALE.....	161
SMA FEMALE BULKHEAD.....	157
SMA FEMALE BULKHEAD.....	158
SMA FEMALE BULKHEAD.....	161
SMA FEMALE BULKHEAD.....	162
SMA MALE.....	159
SMA MALE RIGHT ANGLE.....	157
SMA MALE RIGHT ANGLE.....	160
SMA MALE RIGHT ANGLE.....	161
SMB PLUG.....	162

Connector Type	Page
SMB PLUG RIGHT ANGLE.....	162
SMC PLUG RIGHT ANGLE.....	162
SSMC JACK BULKHEAD.....	162
SSMC PLUG.....	162
SSMC PLUG RIGHT ANGLE.....	162
TNC FEMALE BULKHEAD.....	163
TNC MALE.....	158
TNC MALE.....	162
TNC MALE.....	163
TNC MALE RIGHT ANGLE.....	163
<b>SMB Plug To:</b>	
BNC MALE.....	171
N FEMALE.....	171
SMB JACK BULKHEAD.....	172
SMB PLUG.....	171
SMB PLUG RIGHT ANGLE.....	171
SMB PLUG RIGHT ANGLE.....	172
<b>SMB Plug Right Angle To:</b>	
BNC MALE.....	172
SMB JACK BULKHEAD.....	172
SMB JACK BULKHEAD.....	173
SMB PLUG RIGHT ANGLE.....	172
SSMB PLUG.....	173
<b>SMC Plug To:</b>	
10-32 MALE RIGHT ANGLE.....	173
BNC MALE.....	173
MCX PLUG.....	173
SMA MALE.....	173
SMC JACK BULKHEAD.....	174
SMC PLUG.....	173
SMC PLUG RIGHT ANGLE.....	173
SMC PLUG RIGHT ANGLE.....	174
<b>SMC Plug Right Angle To:</b>	
BNC MALE.....	174
SMC JACK BULKHEAD.....	174
SMC PLUG RIGHT ANGLE.....	174
TNC FEMALE BULKHEAD.....	174
<b>SMP Female To:</b>	
SMA MALE.....	174
SMP FEMALE.....	174
SMP FEMALE.....	175
SMP FEMALE RIGHT ANGLE.....	175
<b>SMP Female Right Angle To:</b>	
MMCX PLUG RIGHT ANGLE.....	175
N FEMALE BULKHEAD.....	175
REVERSE POLARITY TNC FEMALE BULKHEAD.....	175
SMA FEMALE.....	175
SMA MALE RIGHT ANGLE.....	175
SMP FEMALE.....	175
SMP FEMALE RIGHT ANGLE.....	175
<b>SMP Male Bulkhead To:</b>	
SMA MALE.....	174
<b>SSMA Male To:</b>	
SSMA MALE.....	175
SSMA MALE RIGHT ANGLE.....	175
<b>SSMA Male Right Angle To:</b>	
SSMA MALE RIGHT ANGLE.....	175
<b>SSMB Plug To:</b>	
SMA MALE.....	176
SSMB PLUG.....	176
<b>SSMB Plug Right Angle To:</b>	
SSMB PLUG RIGHT ANGLE.....	176
<b>SSMC Jack Bulkhead To:</b>	
SSMC JACK RIGHT ANGLE BULKHEAD.....	177
<b>SSMC Jack Right Angle Bulkhead To:</b>	
SSMC JACK RIGHT ANGLE BULKHEAD.....	177
<b>SSMC Plug To:</b>	
SMB JACK BULKHEAD.....	176
SSMC JACK BULKHEAD.....	176
SSMC PLUG.....	176
SSMC PLUG RIGHT ANGLE.....	176
<b>SSMC Plug Right Angle To:</b>	
SMA MALE.....	176
SSMC JACK BULKHEAD.....	177
SSMC PLUG RIGHT ANGLE.....	176
TNC FEMALE BULKHEAD.....	177

Connector Type	Page
<b>TNC Female To:</b>	
N FEMALE.....	92
N MALE.....	92
N MALE RIGHT ANGLE.....	92
TNC FEMALE.....	92
TNC MALE RIGHT ANGLE.....	92
NMO Mount Sexless.....	185
SMA MALE.....	181
TNC MALE.....	182
<b>TNC Female Bulkhead To:</b>	
MCX PLUG RIGHT ANGLE.....	182
MMCX PLUG RIGHT ANGLE.....	182
N FEMALE BULKHEAD.....	182
N MALE.....	182
N MALE RIGHT ANGLE.....	182
SMA MALE RIGHT ANGLE.....	182
SMC PLUG RIGHT ANGLE.....	182
SMP FEMALE RIGHT ANGLE.....	182
SSMC PLUG RIGHT ANGLE.....	182
TNC FEMALE BULKHEAD.....	183
TNC MALE.....	183
TNC MALE RIGHT ANGLE.....	183
UMCX PLUG RIGHT ANGLE.....	183
<b>TNC Male To:</b>	
N FEMALE.....	92
N MALE.....	92
N MALE RIGHT ANGLE.....	92
TNC FEMALE.....	92
TNC MALE.....	91
TNC MALE.....	92
TNC MALE RIGHT ANGLE.....	92
BNC MALE.....	177
MINI UHF MALE.....	177
N FEMALE BULKHEAD.....	178
N MALE.....	178
N MALE RIGHT ANGLE.....	178
REVERSE POLARITY TNC MALE.....	180
SMA MALE.....	178
SMA MALE RIGHT ANGLE.....	178
SMB PLUG RIGHT ANGLE.....	178
SMP FEMALE RIGHT ANGLE.....	178
TNC FEMALE.....	180
TNC FEMALE BULKHEAD.....	180
TNC MALE.....	177
TNC MALE.....	178
TNC MALE.....	179
TNC MALE.....	180
TNC MALE RIGHT ANGLE.....	180
<b>TNC Male Right Angle To:</b>	
N FEMALE.....	92
N MALE.....	92
N MALE RIGHT ANGLE.....	92
TNC MALE RIGHT ANGLE.....	92
N FEMALE BULKHEAD.....	181
N MALE.....	181
N MALE RIGHT ANGLE.....	181
TNC FEMALE.....	181
TNC FEMALE BULKHEAD.....	181
TNC MALE.....	181
TNC MALE RIGHT ANGLE.....	181
<b>UHF Male To:</b>	
BNC MALE.....	183
BNC MALE.....	184
UHF MALE.....	184
<b>UMCX 2.1 Plug To:</b>	
UMCX 2.1 PLUG.....	184
<b>UMCX 2.5 Plug To:</b>	
UMCX 2.5 PLUG.....	184
<b>UMCX Plug Right Angle To:</b>	
MCX JACK BULKHEAD.....	184
MCX PLUG.....	184
MCX PLUG RIGHT ANGLE.....	184
MMCX PLUG RIGHT ANGLE.....	184
<b>WMCX 1.6 Plug To:</b>	
WMCX 1.6 PLUG.....	184



## HIGH-RELIABILITY RF CABLE ASSEMBLIES

### Product Features

- Max. Frequency as High as 18 GHz
- Double and Triple Shielded Versions
- Lot Traceability
- J-STD-Soldering
- High-Reliability Cable and Connectors
- RF Test Plots
- Detailed Test Report
- In-Stock and Shipped Same Day

### Applications

- Hi-Rel
- MIL-DTL-17 Requirements
- Avionics
- IFF
- SATCOM
- ECM



MIL-DTL-17 Cable Assembly Series



Temperature Conditioned, Low Loss Cable Assembly Series

Pasternack's MIL-DTL-17 Cable Assemblies and Temperature-Conditioned, Low-Loss Cable Assemblies are part of a full line of high-reliability RF components that are in-stock and available for shipment same day. These Commercial-Off-The-Shelf (COTS) assemblies offer a combination of superior materials, processes, and acceptance testing designed to ensure rugged, highly reliable performance for your mission critical applications.

Each assembly is manufactured using J-STD soldering processes and WHMA-A-620 workmanship and is also traceable to its component lots for every material used (RF connectors, coax cable, heat shrink, and solder). There is 100% test sampling of assemblies for connector gaging, insertion loss, VSWR, DWV, workmanship, configuration, and marking, with sampled (AQL) inspections performed for length and mass. A detailed test report accompanies each assembled lot.

Whether the need is to provide a high-reliability MIL-SPEC connection or a rugged, dependable cable assembly, Pasternack has the right assembly for the job. Visit us online at [www.pasternack.com](http://www.pasternack.com) to configure and customize your order, or sign up for our mailing list to receive the latest news and product information.

### MIL-DTL-17 BNC CABLE ASSEMBLY SERIES

Model No	Cable Type	Velocity of Propagation (%)	Connector 1	Connector 2	Frequency Max. (GHz)	ROW
<b>M17/28-RG058</b>						
<a href="#">PE3M0115</a>	M17/28-RG058	65.9	BNC, Male	BNC, Male	1	1
<a href="#">PE3M0116</a>				SMA, Male		2
<a href="#">PE3M0117</a>				SMA, Male, RA		3
<a href="#">PE3M0118</a>				TNC, Male		4
<b>M17/60-RG142</b>						
<a href="#">PE3M0001</a>	M17/60-RG142	69.5	BNC, Male	BNC, Male	4	5
<a href="#">PE3M0002</a>				N, Male		6
<a href="#">PE3M0003</a>				N, Female		7
<a href="#">PE3M0004</a>				SMA, Male		8
<a href="#">PE3M0005</a>				SMA, Male, RA		9
<a href="#">PE3M0006</a>				SMA, Male, RA		10
<a href="#">PE3M0007</a>				TNC, Male		11
<b>M17/84-RG223</b>						
<a href="#">PE3M0029</a>	M17/84-RG223	65.9	BNC, Male	BNC, Male	4	12
<a href="#">PE3M0030</a>				N, Male		13
<a href="#">PE3M0031</a>				N, Female		14
<a href="#">PE3M0032</a>				SMA, Male		15
<a href="#">PE3M0033</a>				SMA, Male, RA		16
<a href="#">PE3M0034</a>				TNC, Male		17
<a href="#">PE3M0035</a>	TNC, Male	18				
<b>M17/113-RG316</b>						
<a href="#">PE3M0085</a>	M17/113-RG316	69.5	BNC, Male	BNC, Male	3	19
<a href="#">PE3M0086</a>				SMA, Male		20
<a href="#">PE3M0087</a>				SMA, Male, RA		21
<a href="#">PE3M0088</a>				SMA, Female		22
<a href="#">PE3M0089</a>				TNC, Male		23
<b>M17/119-RG174</b>						
<a href="#">PE3M0100</a>	M17/119-RG174	65.9	BNC, Male	BNC, Male	1	24
<a href="#">PE3M0101</a>				SMA, Male		25
<a href="#">PE3M0102</a>				SMA, Male, RA		26
<a href="#">PE3M0103</a>				SMA, Female		27
<a href="#">PE3M0104</a>				TNC, Male		28
<b>M17/128-RG400</b>						
<a href="#">PE3M0057</a>	M17/128-RG400	69.5	BNC, Male	BNC, Male	4	29
<a href="#">PE3M0058</a>				N, Male		30
<a href="#">PE3M0059</a>				N, Female		31
<a href="#">PE3M0060</a>				SMA, Male		32
<a href="#">PE3M0061</a>				SMA, Male, RA		33
<a href="#">PE3M0062</a>				SMA, Male, RA		34
<a href="#">PE3M0063</a>				TNC, Male		35

### MIL-DTL-17 N TYPE CABLE ASSEMBLY SERIES

Model No	Cable Type	Velocity of Propagation (%)	Connector 1	Connector 2	Frequency Max. (GHz)	ROW
<b>M17/60-RG142</b>						
<a href="#">PE3M0008</a>	M17/60-RG142	69.5	N, Male	N, Male	11	36
<a href="#">PE3M0009</a>				N, Female		37
<a href="#">PE3M0010</a>				N, Female		38
<a href="#">PE3M0014</a>				SMA, Male		39
<a href="#">PE3M0015</a>				SMA, Male, RA		40
<a href="#">PE3M0016</a>				TNC, Male		41
<a href="#">PE3M0011</a>				N, Female		42
<a href="#">PE3M0012</a>				N, Female		43
<a href="#">PE3M0013</a>				N, Female		44
<a href="#">PE3M0017</a>				SMA, Male		45
<a href="#">PE3M0020</a>				SMA, Male, RA		46
<a href="#">PE3M0018</a>	SMA, Male, RA	47				
<a href="#">PE3M0021</a>	TNC, Male	48				
<a href="#">PE3M0019</a>	TNC, Male	49				
<a href="#">PE3M0022</a>	TNC, Male	50				
<b>M17/84-RG223</b>						
<a href="#">PE3M0036</a>	M17/84-RG223	65.9	N, Male	N, Male	11	51
<a href="#">PE3M0037</a>				N, Female		52
<a href="#">PE3M0038</a>				SMA, Male		53
<a href="#">PE3M0042</a>				SMA, Male, RA		54
<a href="#">PE3M0043</a>				SMA, Male, RA		55
<a href="#">PE3M0044</a>				TNC, Male		56
<a href="#">PE3M0039</a>				N, Female		57
<a href="#">PE3M0040</a>				N, Female		58
<a href="#">PE3M0041</a>				N, Female		59
<a href="#">PE3M0045</a>				SMA, Male		60
<a href="#">PE3M0048</a>				SMA, Male, RA		61
<a href="#">PE3M0046</a>				SMA, Male, RA		62
<a href="#">PE3M0049</a>				TNC, Male		63
<a href="#">PE3M0047</a>				TNC, Male		64
<a href="#">PE3M0050</a>				TNC, Male		65
<b>M17/128-RG400</b>						
<a href="#">PE3M0064</a>	M17/128-RG400	69.5	N, Male	N, Male	11	66
<a href="#">PE3M0065</a>				N, Female		67
<a href="#">PE3M0066</a>				N, Female		68
<a href="#">PE3M0070</a>				SMA, Male		69
<a href="#">PE3M0071</a>				SMA, Male, RA		70
<a href="#">PE3M0072</a>				TNC, Male		71
<a href="#">PE3M0067</a>				N, Female		72
<a href="#">PE3M0068</a>				N, Female		73

Cable Assemblies

See Our Website For Current Pricing & Real-Time Stock Availability!



For our complete selection of cable assemblies, please visit our website

MIL-DTL-17 N TYPE CABLE ASSEMBLY SERIES						
Model No	Cable Type	Velocity of Propagation (%)	Connector 1	Connector 2	Frequency Max. (GHz)	ROW
<b>M17/128-RG400</b>						
PE3M0069	M17/128-RG400	69.5	N, Female	N, Female	11	74
PE3M0073				SMA, Male		75
PE3M0076				SMA, Male, RA		76
PE3M0074				SMA, Male, RA		77
PE3M0077				TNC, Male		78
PE3M0075						79
PE3M0078						80

MIL-DTL-17 SMA CABLE ASSEMBLY SERIES						
Model No	Cable Type	Velocity of Propagation (%)	Connector 1	Connector 2	Frequency Max. (GHz)	ROW
<b>M17/28-RG058</b>						
PE3M0119	M17/28-RG058	65.9	SMA, Male	SMA, Male	1	81
PE3M0120				SMA, Male, RA		82
PE3M0122				TNC, Male		83
PE3M0121				SMA, Male, RA		84
PE3M0123				TNC, Male		85

<b>M17/60-RG142</b>						
PE3M0023	M17/60-RG142	69.5	SMA, Male	SMA, Male	12.4	86
PE3M0024				SMA, Male, RA		87
PE3M0026				TNC, Male		88
PE3M0025				SMA, Male, RA		89
PE3M0027				TNC, Male		90

<b>M17/84-RG223</b>						
PE3M0051	M17/84-RG223	65.9	SMA, Male	SMA, Male	12.4	91
PE3M0052				SMA, Male, RA		92
PE3M0054				TNC, Male		93
PE3M0053				SMA, Male, RA		94
PE3M0055				TNC, Male		95

<b>M17/113-RG316</b>						
PE3M0090	M17/113-RG316	69.5	SMA, Male	SMA, Male	3	96
PE3M0091				SMA, Male, RA		97
PE3M0092				SMA, Female		98
PE3M0096				TNC, Male		99
PE3M0093				SMA, Male, RA		1
PE3M0094				SMA, Female		2
PE3M0097				TNC, Male		3
PE3M0095				SMA, Female		4
PE3M0098				TNC, Male		5

<b>M17/119-RG174</b>						
PE3M0105	M17/119-RG174	65.9	SMA, Male	SMA, Male	1	6
PE3M0106				SMA, Male, RA		7
PE3M0107				SMA, Female		8
PE3M0111				TNC, Male		9
PE3M0108				SMA, Male, RA		10
PE3M0109				SMA, Female		11
PE3M0112				TNC, Male		12
PE3M0110				SMA, Female		13
PE3M0113				TNC, Male		14

<b>M17/128-RG400</b>						
PE3M0079	M17/128-RG400	69.5	SMA, Male	SMA, Male	12.4	15
PE3M0080				SMA, Male, RA		16
PE3M0082				TNC, Male		17
PE3M0081				SMA, Male, RA		18
PE3M0083				TNC, Male		19

MIL-DTL-17 TNC CABLE ASSEMBLY SERIES						
Model No	Cable Type	Velocity of Propagation (%)	Connector 1	Connector 2	Frequency Max. (GHz)	ROW
<b>M17/28-RG058</b>						
PE3M0124	M17/28-RG058	65.9	TNC, Male	TNC, Male	1	20
<b>M17/60-RG142</b>						
PE3M0028	M17/60-RG142	69.5	TNC, Male	TNC, Male	11	21
<b>M17/84-RG223</b>						
PE3M0056	M17/84-RG223	65.9	TNC, Male	TNC, Male	11	22
<b>M17/113-RG316</b>						
PE3M0099	M17/113-RG316	69.5	TNC, Male	TNC, Male	3	23

Model No	Cable Type	Velocity of Propagation (%)	Connector 1	Connector 2	Frequency Max. (GHz)	ROW
<b>M17/119-RG174</b>						
PE3M0114	M17/119-RG174	65.9	TNC, Male	TNC, Male	1	24
<b>M17/128-RG400</b>						
PE3M0084	M17/128-RG400	69.5	TNC, Male	TNC, Male	11	25

TEMPERATURE CONDITIONED, LOW LOSS N TYPE CABLE ASSEMBLY SERIES						
Model No	Cable Type	Velocity of Propagation (%)	Connector 1	Connector 2	Frequency Max. (GHz)	ROW
<b>PE-P142LL</b>						
PE3M0174	PE-P142LL	80	N, Male	N, Male	18	26
PE3M0176				N, Male, RA		27
PE3M0175				N, Female		28
PE3M0179				N, Male, RA		29
PE3M0178				N, Male, RA		30
PE3M0177				N, Female		31

<b>PE-P160LL</b>						
PE3M0219	PE-P160LL	82.5	N, Male	N, Male	18	32
PE3M0221				N, Male, RA		33
PE3M0220				N, Female		34
PE3M0224				N, Male, RA		35
PE3M0223				N, Male, RA		36
PE3M0222				N, Female		37

<b>PE-P300LL</b>						
PE3M0247	PE-P300LL	83	N, Male	N, Male	18	38
PE3M0249				N, Male, RA		39
PE3M0248				N, Female		40
PE3M0252				N, Male, RA		41
PE3M0251				N, Male, RA		42
PE3M0250				N, Female		43

TEMPERATURE CONDITIONED, LOW LOSS SMA CABLE ASSEMBLY SERIES										
Model No	Cable Type	Velocity of Propagation (%)	Connector 1	Connector 2	Frequency Max. (GHz)	ROW				
<b>PE-P142LL</b>										
PE3M0132	PE-P142LL	80	SMA, Male	N, Male	18	44				
PE3M0134				N, Male, RA		45				
PE3M0133				N, Female		46				
PE3M0125				SMA, Male		47				
PE3M0128				SMA, Male, RA		48				
PE3M0126				SMA, Female		49				
PE3M0127				SMA, Female		50				
PE3M0129				TNC, Male		51				
PE3M0131				TNC, Male, RA		52				
PE3M0130				TNC, Female		53				
PE3M0156				N, Male		54				
PE3M0158				N, Male, RA		55				
PE3M0157				N, Female		56				
PE3M0152				SMA, Male, RA		57				
PE3M0153				TNC, Male		58				
PE3M0155				TNC, Male, RA		59				
PE3M0154				TNC, Female		60				
PE3M0141				N, Male		61				
PE3M0149				N, Male, RA		62				
PE3M0143				N, Male, RA		63				
PE3M0151				N, Female		64				
PE3M0142				N, Female		65				
PE3M0150				SMA, Male, RA		66				
PE3M0137				SMA, Male, RA		67				
PE3M0145				SMA, Female		68				
PE3M0135				SMA, Female		69				
PE3M0136				SMA, Female		70				
PE3M0144				TNC, Male		71				
PE3M0138				TNC, Male		72				
PE3M0146				TNC, Male		73				
PE3M0140				TNC, Male, RA		74				
PE3M0148				TNC, Male, RA		75				
PE3M0139				TNC, Female		76				
PE3M0147				TNC, Female		77				
<b>PE-P160LL</b>										
PE3M0186				PE-P160LL		82.5	SMA, Male	N, Male	18	78
PE3M0188								N, Male, RA		79
PE3M0187								N, Female		80

Cable Assemblies

See Our Website For Current Pricing & Real-Time Stock Availability!

For Custom Lengths, Metric Lengths or Special Configurations, Please call (949) 261-1920



Technical Support  
+1 (949) 261-1920



Same-Day Shipping,  
Even Custom Cable Assemblies

For our complete selection of cable assemblies, please visit our website

Model No	Cable Type	Velocity of Propagation (%)	Connector 1	Connector 2	Frequency Max. (GHz)	R O W
<b>PE-P160LL</b>						
PE3M0180	PE-P160LL	82.5	SMA, Male	SMA, Male	18	81
PE3M0182				SMA, Male, RA		82
PE3M0181				SMA, Female		83
PE3M0183				TNC, Male		84
PE3M0185				TNC, Male, RA		85
PE3M0184				TNC, Female		86
PE3M0201				N, Male		87
PE3M0203				N, Male, RA		88
PE3M0202				N, Female		89
PE3M0197				SMA, Male, RA		90
PE3M0198			TNC, Male	91		
PE3M0200			TNC, Male, RA	92		
PE3M0199			TNC, Female	93		
PE3M0194			N, Male	94		
PE3M0196			N, Male, RA	95		
PE3M0195			N, Female	96		
PE3M0190			SMA, Male, RA	97		
PE3M0189			SMA, Female	98		
PE3M0191			TNC, Male	99		
PE3M0193			TNC, Male, RA	1		
PE3M0192	TNC, Female	2				
<b>PE-P300LL</b>						
PE3M0229	PE-P300LL	83	SMA, Male	N, Male	18	3
PE3M0231				N, Male, RA		4
PE3M0230				N, Female		5
PE3M0225				SMA, Male		6
PE3M0226				SMA, Male, RA		7
PE3M0227				TNC, Male		8
PE3M0228				TNC, Male, RA		9
PE3M0235				N, Male		10
PE3M0237				N, Male, RA		11
PE3M0236				N, Female		12
PE3M0232			SMA, Male, RA	13		
PE3M0233			TNC, Male	14		
PE3M0234			TNC, Male, RA	15		

**TEMPERATURE CONDITIONED,  
LOW LOSS TNC CABLE ASSEMBLY SERIES**

Model No	Cable Type	Velocity of Propagation (%)	Connector 1	Connector 2	Frequency Max. (GHz)	R O W
<b>PE-P142LL</b>						
PE3M0162	PE-P142LL	80	TNC, Male	N, Male	18	16

Model No	Cable Type	Velocity of Propagation (%)	Connector 1	Connector 2	Frequency Max. (GHz)	R O W			
<b>PE-P142LL</b>									
PE3M0164	PE-P142LL	80	TNC, Male	N, Male, RA	18	17			
PE3M0163				N, Female		18			
PE3M0159				TNC, Male		19			
PE3M0161				TNC, Male, RA		20			
PE3M0160				TNC, Female		21			
PE3M0171				N, Male		22			
PE3M0173			N, Male, RA	23					
PE3M0172			N, Female	24					
PE3M0170			TNC, Male, RA	25					
PE3M0167			N, Male	26					
PE3M0169			N, Male, RA	27					
PE3M0168			N, Female	28					
PE3M0166			TNC, Male, RA	29					
PE3M0165			TNC, Female	30					
<b>PE-P160LL</b>									
PE3M0207	PE-P160LL	82.5	TNC, Male	N, Male	18	31			
PE3M0209				N, Male, RA		32			
PE3M0208				N, Female		33			
PE3M0204				TNC, Male		34			
PE3M0206				TNC, Male, RA		35			
PE3M0205				TNC, Female		36			
PE3M0216				N, Male		37			
PE3M0218				N, Male, RA		38			
PE3M0217				N, Female		39			
PE3M0215				TNC, Male, RA		40			
PE3M0212			N, Male	41					
PE3M0214			N, Male, RA	42					
PE3M0213			N, Female	43					
PE3M0211			TNC, Male, RA	44					
PE3M0210			TNC, Female	45					
<b>PE-P300LL</b>									
PE3M0240			PE-P300LL	83		TNC, Male	N, Male	18	46
PE3M0242							N, Male, RA		47
PE3M0241							N, Female		48
PE3M0238							TNC, Male		49
PE3M0239	TNC, Male, RA	50							
PE3M0244	N, Male	51							
PE3M0246	N, Male, RA	52							
PE3M0245	N, Female	53							
PE3M0243	TNC, Male, RA	54							

Cable Assemblies

See Our Website For Current Pricing & Real-Time Stock Availability!

**LOW PIM CABLE ASSEMBLIES**

**Product Features**

- 100% PIM Tested, Results Marked on Cable
- Max Frequency 6 GHz
- Low PIM: < -160 dBc Max
- 76% Phase Velocity
- FEP Jacket
- UL910 Plenum-Rated Cable
- Lightweight and Extremely Flexible
- Low Loss with Excellent VSWR

- IP67 (when mated)
- Shielding Effectivity > 100 dB
- Connector Options: 4.3-10, SMA, QMA, 7/16 DIN, 4.1/9.5, Type-N

**Applications**

- Low PIM Applications
- Distributed Antenna Systems (DAS)
- Plenum Installations
- Multi-Carrier Communication Systems
- PIM Testing



Low PIM Cable Assemblies

Pasternack's Low PIM Cable Assemblies offer a wide range of connector options: 4.3-10, SMA, QMA, 7/16 DIN, 4.1/9.5, and Type-N. These assemblies deliver low PIM performance to support Distributed Antenna Systems (DAS) and other complex, multi-carrier cable installations. All low PIM assemblies are 100% PIM tested with test results marked on the cable.

Whether the need is to provide a low PIM jumper connection, low PIM test cable, or simply create a custom assembly, Pasternack has the right cable for the job. Low PIM assemblies are part of Pasternack's full line of RF components that are available for same-day shipping. We are continually adding new cables and connectors to the low PIM family. So please visit us online at [www.pasternack.com](http://www.pasternack.com) to see the newest additions, or sign up for our mailing list to receive the latest news and product information.

For our complete selection of cable assemblies, please visit our website

4.1/9.5 MINI DIN LOW PIM PLENUM RATED CABLE ASSEMBLY SERIES								
Model No	Cable Type	Velocity of Propagation (%)	Connector 1	Connector 2	Freq. Max. (GHz)	PIM (dBc)	R O W	
<b>SPP-250-LLPL</b>								
PE3C4143	SPP-250-LLPL	76	4.1/9.5 Mini DIN, Male	4.1/9.5 Mini DIN, Male	5.8	-160	1	
PE3C5847				4.1/9.5 Mini DIN, Male, RA			2	
PE3C5841				4.1/9.5 Mini DIN, Female			3	
PE3C5834				4.3-10, Female			4	
PE3C4134				7/16 DIN, Male			5	
PE3C5854				7/16 DIN, Female			6	
PE3W07481				N, Female			7	
PE3C5866				QMA, Male			8	
PE3C5872				QMA, Male, RA			9	
PE3C5860				QMA, Female			10	
PE3C5885			SMA, Male	11				
PE3C5890			SMA, Male, RA	12				
PE3C5879			SMA, Female	13				
PE3C5852			4.1/9.5 Mini DIN, Male, RA	76	4.1/9.5 Mini DIN, Male, RA	5.8	-160	14
PE3C5846					4.3-10, Male			15
PE3C5950					4.3-10, Female			16
PE3C5848					7/16 DIN, Male			17
PE3C5849					N, Male			18
PE3C5850					QMA, Male			19
PE3C5851			SMA, Male	20				
PE3C5840			4.1/9.5 Mini DIN, Female	76	4.3-10, Male	-160	-155	21
PE3C5842					7/16 DIN, Male			22
PE3C5843					N, Male			23
PE3C5844					QMA, Male			24
PE3C5845					SMA, Male			25
<b>PE-SR402FLJ Low PIM</b>								
PE3C2009	PE-SR402FLJ Low PIM	70	4.1/9.5 Mini DIN, Male	3	-160	26		
PE3C2010			4.1/9.5 Mini DIN, Female			27		

4.3/10 DIN LOW PIM PLENUM RATED CABLE ASSEMBLY SERIES								
Model No	Cable Type	Velocity of Propagation (%)	Connector 1	Connector 2	Freq. Max. (GHz)	PIM (dBc)	R O W	
<b>SPP-250-LLPL</b>								
PE3C4142	SPP-250-LLPL	76	4.3-10, Male	4.3-10, Male	5.8	-160	28	
PE3C5833				4.3-10, Female			29	
PE3C4135				7/16 DIN, Male			30	
PE3C5853				7/16 DIN, Female			31	
PE3C5865				QMA, Male			32	
PE3C5871				QMA, Male, RA			33	
PE3C5859				QMA, Female			34	
PE3C5884				SMA, Male			35	
PE3C5869				SMA, Male, RA			36	
PE3C5878				SMA, Female			37	
PE3C4147			4.3-10, Male, RA	76	4.3-10, Male	6	-160	38
PE3C4146					4.3-10, Male, RA			39
PE3C5836					7/16 DIN, Male			40
PE3C5837					N, Male			41
PE3C5838			4.3-10, Female	76	QMA, Male	5.8	-150	42
PE3C5839					SMA, Male			43

7/16 DIN LOW PIM PLENUM RATED CABLE ASSEMBLY SERIES							
Model No	Cable Type	Velocity of Propagation (%)	Connector 1	Connector 2	Freq. Max. (GHz)	PIM (dBc)	R O W
<b>SPP-250-LLPL</b>							
PE3C4130	SPP-250-LLPL	76	7/16 DIN, Male	7/16 DIN, Male	5.8	-160	44
PE3C5855				7/16 DIN, Female			45
PE3C5867				QMA, Male			46
PE3C5873				QMA, Male, RA			47
PE3C5861				QMA, Female			48
PE3C5886				SMA, Male			49
PE3C5891			SMA, Male, RA	50			
PE3C5880			SMA, Female	51			
PE3C4131			7/16 DIN, Male, RA	7/16 DIN, Male	6	-160	52

Model No	Cable Type	Velocity of Propagation (%)	Connector 1	Connector 2	Freq. Max. (GHz)	PIM (dBc)	R O W
<b>SPP-250-LLPL</b>							
PE3C4144	SPP-250-LLPL	76	7/16 DIN, Male, RA	7/16 DIN, Male, RA	5.8	-160	53
PE3C5856				N, Male			54
PE3C5857			7/16 DIN, Female	QMA, Male			55
PE3C5858				SMA, Male			56
<b>PE-SR402FLJ Low PIM</b>							
PE3C2003	PE-SR402FLJ Low PIM	70	7/16 DIN, Male	7/16 DIN, Male	3	-160	57
PE3C2004				7/16 DIN, Female			58
<b>PE-SR401FLJ Low PIM</b>							
PE3C2013	PE-SR401FLJ Low PIM	70	7/16 DIN, Male	7/16 DIN, Male	3	-160	59
PE3C2015				7/16 DIN, Female			60

QMA LOW PIM PLENUM RATED CABLE ASSEMBLY SERIES									
Model No	Cable Type	Velocity of Propagation (%)	Connector 1	Connector 2	Freq. Max. (GHz)	PIM (dBc)	R O W		
<b>SPP-250-LLPL</b>									
PE3C5869	SPP-250-LLPL	76	QMA, Male	QMA, Male	5.8	-150	61		
PE3C5875				QMA, Male, RA			62		
PE3C5863				QMA, Female			63		
PE3C5870				SMA, Male			64		
PE3C5893				SMA, Male, RA			65		
PE3C5882				SMA, Female			66		
PE3C5877				QMA, Male, RA			67		
PE3C5876				QMA, Male, RA			68		
PE3C5864				QMA, Female			SMA, Male	-150	69

SMA LOW PIM PLENUM RATED CABLE ASSEMBLY SERIES							
Model No	Cable Type	Velocity of Propagation (%)	Connector 1	Connector 2	Freq. Max. (GHz)	PIM (dBc)	R O W
<b>SPP-250-LLPL</b>							
PE3C5888	SPP-250-LLPL	76	SMA, Male	SMA, Male	5.8	-155	70
PE3C5894				SMA, Male, RA			71
PE3C5883				SMA, Female			72
PE3C5895				SMA, Male, RA			SMA, Male, RA
<b>PE-SR402FLJ Low PIM</b>							
PE3C2007	PE-SR402FLJ Low PIM	70	SMA, Male	7/16 DIN, Male	3	-150	74
PE3C2008				SMA, Male			75

TYPE N LOW PIM PLENUM RATED CABLE ASSEMBLY SERIES									
Model No	Cable Type	Velocity of Propagation (%)	Connector 1	Connector 2	Freq. Max. (GHz)	PIM (dBc)	R O W		
<b>SPP-250-LLPL</b>									
PE3C4140	SPP-250-LLPL	76	N, Male	4.1/9.5 Mini DIN, Male	5.8	-160	76		
PE3C4141				4.3-10, Male			77		
PE3C4132				7/16 DIN, Male			78		
PE3C4136				7/16 DIN, Male, RA			79		
PE3C4137				N, Male			80		
PE3C5868				QMA, Male			-150	81	
PE3C5874				QMA, Male, RA			-145	82	
PE3C5862				QMA, Female			-150	83	
PE3C5887				SMA, Male			84		
PE3C5892				SMA, Male, RA			-155	85	
PE3C5881				SMA, Female			86		
PE3C4139				N, Male			6	87	
PE3C4145				N, Male, RA			5.8	-160	88
PE3C4133				7/16 DIN, Male			6	89	
PE3C4138				N, Male			5.8	90	
PE3W07489				N, Female			5.8	91	
<b>PE-SR402FLJ Low PIM</b>									
PE3C2002	PE-SR402FLJ Low PIM	70	N, Male	7/16 DIN, Male	3	-160	92		
PE3C2005				7/16 DIN, Female			93		
PE3C2000				N, Male			94		
PE3C2001				N, Female			95		
PE3C2006				SMA, Male			-150	96	
<b>PE-SR401FLJ Low PIM</b>									
PE3C2012	PE-SR401FLJ Low PIM	70	N, Male	7/16 DIN, Male	3	-160	97		
PE3C2014				7/16 DIN, Female			98		
PE3C2011				N, Male			99		

Cable Assemblies

See Our Website For Current Pricing & Real-Time Stock Availability!

For Custom Lengths, Metric Lengths or Special Configurations, Please call (949) 261-1920



Technical Support  
+1 (949) 261-1920











Same-Day Shipping,  
Even Custom Cable Assemblies

For our complete selection of cable assemblies, please visit our website

Cable Assemblies

See Our Website For Current Pricing & Real-Time Stock Availability!

<b>1.0/2.3 PLUG TO BNC FEMALE BULKHEAD</b>							
SEE MOUNTING HOLE SECTION ON PAGE 369							
<b>Flexible Cable Assemblies</b>							
LMR-100A-PVC Coax, 50 Ohm							
Part No. <a href="#">PE3W05192</a>	Cable Dia.	Attn. @ 1 GHz	Power @ 1 GHz				1
1 piece price shown. See web or call for volume pricing.							
12"	24"	36"	48"	60"	50CM	Custom Len.	
\$37.62	\$38.35	\$39.08	\$39.80	\$40.53	\$38.09	See Web	
<b>1.0/2.3 PLUG RIGHT ANGLE TO BNC MALE</b>							
<b>Standard Flexible Cable Assemblies</b>							
RG316/U Coax, 50 Ohm							
Part No. <a href="#">PE3C3469</a>	Cable Dia.	Attn. @ 1 GHz	Power @ 1 GHz				2
1 piece price shown. See web or call for volume pricing.							
12"	24"	36"	48"	60"	50CM	Custom Len.	
\$42.95	\$45.99	\$49.02	\$52.05	\$55.09	\$44.90	See Web	
<b>1.0/2.3 JACK BULKHEAD TO 1.0/2.3 JACK BULKHEAD</b>							
SEE MOUNTING HOLE SECTION ON PAGE 369							
<b>Standard Flexible Cable Assemblies</b>							
RG316/U Coax, 50 Ohm							
Part No. <a href="#">PE3C0441</a>	Cable Dia.	Attn. @ 1 GHz	Power @ 1 GHz				3
1 piece price shown. See web or call for volume pricing.							
12"	24"	36"	48"	60"	72"	Custom Len.	
\$47.57	\$50.45	\$53.35	\$56.27	\$59.17	\$62.06	See Web	
<b>1.0MM MALE TO 1.0MM MALE</b>							
<b>Precision Flexible Cable Assemblies</b>							
PE-110TC Coax, 50 Ohm							
Part No. <a href="#">PE3TC1220</a>	Cable Dia.	Attn. @ 1 GHz	Power @ 1 GHz				4
1 piece price shown. See web or call for volume pricing.							
6"	12"	-	-	-	-	Custom Len.	
\$5,878.91	\$7,867.15	-	-	-	-	See Web	
<b>1.85MM MALE TO 1.85MM MALE</b>							
<b>Precision Flexible Cable Assemblies</b>							
PE-VNA-HF Coax, 50 Ohm							
Part No. <a href="#">PE3TC0800</a>	Cable Dia.	Attn. @ 1 GHz	Power @ 1 GHz				5
1 piece price shown. See web or call for volume pricing.							
24"	36"	48"	-	-	-	Custom Len.	
\$2,884.71	\$2,922.71	\$3,024.63	-	-	-	See Web	
<b>Low Loss Flexible Cable Assemblies</b>							
PE-P106LL Coax, 50 Ohm							
Part No. <a href="#">PE3C5998</a>	Cable Dia.	Attn. @ 1 GHz	Power @ 1 GHz				6
1 piece price shown. See web or call for volume pricing.							
6"	12"	24"	36"	50CM	100CM	Custom Len.	
\$569.77	\$591.67	\$591.11	\$650.08	\$571.73	\$669.73	See Web	
<b>Standard Formable Cable Assemblies</b>							
PE-SR047FL Coax, 50 Ohm							
Part No. <a href="#">PE36521</a>	Cable Dia.	Attn. @ 1 GHz	Power @ 1 GHz				7
1 piece price shown. See web or call for volume pricing.							
6"	12"	18"	24"	36"	48"	Custom Len.	
\$378.61	\$378.61	\$382.30	\$385.99	\$393.36	\$400.72	See Web	
<b>PE-SR405FL Coax, 50 Ohm</b>							
Part No. <a href="#">PE36525</a>	Cable Dia.	Attn. @ 1 GHz	Power @ 1 GHz				8
1 piece price shown. See web or call for volume pricing.							
6"	12"	18"	24"	36"	48"	Custom Len.	
\$336.05	\$336.05	\$341.41	\$346.76	\$357.45	\$368.15	See Web	
<b>Standard Flexible Cable Assemblies</b>							
PE-P086 Coax, 50 Ohm							
Part No. <a href="#">PE3C0752</a>	Cable Dia.	Attn. @ 1 GHz	Power @ 1 GHz				9
1 piece price shown. See web or call for volume pricing.							
12"	24"	36"	48"	60"	50CM	Custom Len.	
\$225.43	\$233.37	\$241.32	\$249.71	\$234.56	\$216.17	See Web	
<b>Standard Semi-Rigid Cable Assemblies</b>							
PE-047SR Coax, 50 Ohm							
Part No. <a href="#">PE36519</a>	Cable Dia.	Attn. @ 1 GHz	Power @ 1 GHz				10
1 piece price shown. See web or call for volume pricing.							
6"	12"	18"	24"	36"	48"	Custom Len.	
\$399.06	\$381.54	\$386.65	\$415.50	\$402.01	\$412.25	See Web	

<b>RG405/U Coax, 50 Ohm</b>							
Part No. <a href="#">PE36523</a>	Cable Dia.	Attn. @ 1 GHz	Power @ 1 GHz				11
1 piece price shown. See web or call for volume pricing.							
6"	12"	18"	24"	36"	48"	Custom Len.	
\$332.12	\$332.12	\$335.55	\$338.98	\$345.85	\$352.72	See Web	
<b>Skew Matched Pair Flexible Cable Assemblies</b>							
<b>PE-P106LL Coax, 50 Ohm</b>							
Part No. <a href="#">PE3C5835</a>	Cable Dia.	Attn. @ 1 GHz	Power @ 1 GHz				12
1 piece price shown. See web or call for volume pricing.							
12"	24"	36"	48"	-	-	Custom Len.	
\$3,121.16	\$3,326.18	\$4,002.92	\$4,205.18	-	-	See Web	
<b>1.85MM MALE TO 1.85MM MALE RIGHT ANGLE</b>							
<b>Precision Flexible Cable Assemblies</b>							
PE-VNA-HF Coax, 50 Ohm							
Part No. <a href="#">PE3TC1000</a>	Cable Dia.	Attn. @ 1 GHz	Power @ 1 GHz				13
1 piece price shown. See web or call for volume pricing.							
24"	48"	-	-	-	-	Custom Len.	
\$3,355.10	\$3,498.00	-	-	-	-	See Web	
<b>1.85MM MALE TO 1.85MM FEMALE</b>							
<b>Precision Flexible Cable Assemblies</b>							
PE-VNA-HF Coax, 50 Ohm							
Part No. <a href="#">PE3TC0900</a>	Cable Dia.	Attn. @ 1 GHz	Power @ 1 GHz				14
1 piece price shown. See web or call for volume pricing.							
24"	36"	48"	-	-	-	Custom Len.	
\$2,884.71	\$2,922.71	\$3,024.63	-	-	-	See Web	
<b>2.4MM MALE TO 1.85MM MALE</b>							
<b>Standard Formable Cable Assemblies</b>							
PE-SR405FLJ Coax, 50 Ohm							
Part No. <a href="#">PE3W08014</a>	Cable Dia.	Attn. @ 1 GHz	Power @ 1 GHz				15
1 piece price shown. See web or call for volume pricing.							
12"	18"	24"	36"	48"	60"	Custom Len.	
\$253.65	\$257.96	\$262.27	\$270.89	\$279.51	\$288.13	See Web	
<b>Standard Flexible Cable Assemblies</b>							
PE-P086 Coax, 50 Ohm							
Part No. <a href="#">PE3C0751</a>	Cable Dia.	Attn. @ 1 GHz	Power @ 1 GHz				16
1 piece price shown. See web or call for volume pricing.							
12"	24"	36"	48"	60"	50CM	Custom Len.	
\$172.28	\$180.21	\$188.15	\$196.56	\$184.42	\$166.03	See Web	
<b>2.4MM MALE TO 2.4MM MALE</b>							
<b>Precision Flexible Cable Assemblies</b>							
PE-VNA-HF Coax, 50 Ohm							
Part No. <a href="#">PE3TC0500</a>	Cable Dia.	Attn. @ 1 GHz	Power @ 1 GHz				17
1 piece price shown. See web or call for volume pricing.							
24"	48"	-	-	-	-	Custom Len.	
\$2,789.44	\$2,932.19	-	-	-	-	See Web	
<b>Test Flexible Cable Assemblies</b>							
PE-P160 Coax, 50 Ohm							
Part No. <a href="#">PE363</a>	Cable Dia.	Attn. @ 1 GHz	Power @ 1 GHz				18
1 piece price shown. See web or call for volume pricing.							
36"	48"	100CM	150CM	-	-	Custom Len.	
\$339.32	\$365.21	\$346.59	\$389.07	-	-	See Web	
<b>Standard Flexible Cable Assemblies</b>							
PE-VNA-R Coax, 50 Ohm							
Part No. <a href="#">PE3VNA4004</a>	Cable Dia.	Attn. @ 1 GHz	Power @ 1 GHz				19
1 piece price shown. See web or call for volume pricing.							
24"	48"	-	-	-	-	Custom Len.	
\$1,972.35	\$2,175.54	-	-	-	-	See Web	
<b>PE-P086HF Coax, 50 Ohm</b>							
Part No. <a href="#">PE3C0728</a>	Cable Dia.	Attn. @ 1 GHz	Power @ 1 GHz				20
1 piece price shown. See web or call for volume pricing.							
6"	12"	18"	24"	36"	48"	Custom Len.	
\$204.89	\$208.17	\$211.55	\$214.94	\$221.70	\$228.85	See Web	
<b>Standard Semi-Rigid Cable Assemblies</b>							
PE-SR405AL Coax, 50 Ohm							
Part No. <a href="#">PE35672</a>	Cable Dia.	Attn. @ 1 GHz	Power @ 1 GHz				21
1 piece price shown. See web or call for volume pricing.							
6"	12"	18"	24"	36"	48"	Custom Len.	
\$160.94	\$165.56	\$160.52	\$164.84	\$173.49	\$194.66	See Web	

\*Coax Performance at 1 GHz Notes: Cable assembly max frequency may be lower than connector or coax max frequency

For our complete selection of cable assemblies, please visit our website

2.4MM MALE TO 2.4MM MALE RIGHT ANGLE						
Precision Flexible Cable Assemblies						
PE-VNA-HF Coax, 50 Ohm						
Part No. <a href="#">PE3TC0700</a>	Cable Dia.	Attn. @ 1 GHz	Power @ 1 GHz			
1 piece price shown. See web or call for volume pricing.				0.270" dia.	dB/100ft	W
24"	48"	-	-	-	-	Custom Len.
\$3,262.51	\$3,402.13	-	-	-	-	See Web
2.4MM MALE TO 2.4MM FEMALE						
Precision Flexible Cable Assemblies						
PE-VNA-HF Coax, 50 Ohm						
Part No. <a href="#">PE3TC0600</a>	Cable Dia.	Attn. @ 1 GHz	Power @ 1 GHz			
1 piece price shown. See web or call for volume pricing.				0.270" dia.	dB/100ft	W
24"	48"	-	-	-	-	Custom Len.
\$2,789.44	\$2,932.19	-	-	-	-	See Web
Test Flexible Cable Assemblies						
PE-P160 Coax, 50 Ohm						
Part No. <a href="#">PE364</a>	Cable Dia.	Attn. @ 1 GHz	Power @ 1 GHz			
1 piece price shown. See web or call for volume pricing.				0.160" dia.	13 dB/100ft	W
36"	48"	100CM	150CM	-	-	Custom Len.
\$351.30	\$372.12	\$357.18	\$391.51	-	-	See Web
Standard Flexible Cable Assemblies						
PE-VNA-R Coax, 50 Ohm						
Part No. <a href="#">PE3VNA4005</a>	Cable Dia.	Attn. @ 1 GHz	Power @ 1 GHz			
1 piece price shown. See web or call for volume pricing.				0.430" dia.	dB/100ft	W
24"	48"	-	-	-	-	Custom Len.
\$2,114.23	\$2,325.34	-	-	-	-	See Web
Standard Semi-Rigid Cable Assemblies						
PE-SR405AL Coax, 50 Ohm						
Part No. <a href="#">PE3W00790</a>	Cable Dia.	Attn. @ 1 GHz	Power @ 1 GHz			
1 piece price shown. See web or call for volume pricing.				" dia.	23 dB/100ft	130 W
6"	12"	18"	24"	36"	48"	Custom Len.
\$302.40	\$302.40	\$306.72	\$311.05	\$319.69	\$328.32	See Web
RG405/U Coax, 50 Ohm						
Part No. <a href="#">PE35654</a>	Cable Dia.	Attn. @ 1 GHz	Power @ 1 GHz			
1 piece price shown. See web or call for volume pricing.				" dia.	22 dB/100ft	130 W
6"	12"	18"	24"	36"	48"	Custom Len.
\$290.57	\$294.17	\$297.88	\$301.59	\$309.02	\$316.88	See Web
2.4MM MALE TO 2.92MM MALE						
Standard Flexible Cable Assemblies						
PE-P086 Coax, 50 Ohm						
Part No. <a href="#">PE3C0747</a>	Cable Dia.	Attn. @ 1 GHz	Power @ 1 GHz			
1 piece price shown. See web or call for volume pricing.				0.104" dia.	23 dB/100ft	160 W
12"	24"	36"	48"	60"	72"	Custom Len.
\$239.34	\$247.28	\$255.23	\$263.63	\$271.72	\$248.97	See Web
2.4MM MALE TO SMA MALE						
Standard Semi-Rigid Cable Assemblies						
RG405/U Coax, 50 Ohm						
Part No. <a href="#">PE3C4270</a>	Cable Dia.	Attn. @ 1 GHz	Power @ 1 GHz			
1 piece price shown. See web or call for volume pricing.				" dia.	dB/100ft	130 W
6"	6"	12"	12"	18"	18"	Custom Len.
\$118.46	\$118.46	\$118.46	\$118.46	\$122.07	\$122.07	See Web
2.4MM MALE TO SMA MALE RIGHT ANGLE						
Standard Formable Cable Assemblies						
PE-SR405FL Coax, 50 Ohm						
Part No. <a href="#">PE3W07990</a>	Cable Dia.	Attn. @ 1 GHz	Power @ 1 GHz			
1 piece price shown. See web or call for volume pricing.				" dia.	23 dB/100ft	105 W
12"	18"	24"	36"	48"	60"	Custom Len.
\$131.90	\$137.52	\$143.14	\$154.38	\$165.62	\$176.86	See Web
2.4MM FEMALE TO 2.4MM FEMALE						
Precision Flexible Cable Assemblies						
PE-VNA-HF Coax, 50 Ohm						

Part No. <a href="#">PE3TC0650</a>	Cable Dia.	Attn. @ 1 GHz	Power @ 1 GHz			
1 piece price shown. See web or call for volume pricing.				0.270" dia.	dB/100ft	W
24"	48"	-	-	-	-	Custom Len.
\$2,945.57	\$3,085.57	-	-	-	-	See Web
2.4MM FEMALE BULKHEAD TO SMA MALE						
SEE MOUNTING HOLE SECTION ON PAGE 369						
Standard Formable Cable Assemblies						
PE-SR405FL Coax, 50 Ohm						
Part No. <a href="#">PE3W03550</a>	Cable Dia.	Attn. @ 1 GHz	Power @ 1 GHz			
1 piece price shown. See web or call for volume pricing.				" dia.	23 dB/100ft	105 W
12"	24"	36"	48"	60"	50CM	Custom Len.
\$174.50	\$186.18	\$197.86	\$209.54	\$221.21	\$181.98	See Web
2.92MM MALE TO 2.4MM MALE						
Standard Formable Cable Assemblies						
PE-SR405FL Coax, 50 Ohm						
Part No. <a href="#">PE3W01131</a>	Cable Dia.	Attn. @ 1 GHz	Power @ 1 GHz			
1 piece price shown. See web or call for volume pricing.				" dia.	23 dB/100ft	130 W
12"	24"	36"	48"	60"	50CM	Custom Len.
\$194.14	\$205.15	\$216.16	\$227.18	\$238.19	\$201.19	See Web
2.92MM MALE TO 2.92MM MALE						
Flexible Cable Assemblies						
PE-P160 Coax, 50 Ohm						
Part No. <a href="#">PE360</a>	Cable Dia.	Attn. @ 1 GHz	Power @ 1 GHz			
1 piece price shown. See web or call for volume pricing.				" dia.	13 dB/100ft	1070 W
12"	24"	36"	48"	60"	72"	Custom Len.
\$228.92	\$250.52	\$272.13	\$293.74	\$315.34	\$334.78	See Web
Test Flexible Cable Assemblies						
PE-VNA Coax, 50 Ohm						
Part No. <a href="#">PE319</a>	Cable Dia.	Attn. @ 1 GHz	Power @ 1 GHz			
1 piece price shown. See web or call for volume pricing.				" dia.	dB/100ft	W
24"	36"	48"	60"	72"	-	Custom Len.
\$1,141.68	\$1,359.78	\$1,400.21	\$1,611.55	\$1,893.23	-	See Web
Standard Formable Cable Assemblies						
PE-SR402FL Coax, 50 Ohm						
Part No. <a href="#">PE34733</a>	Cable Dia.	Attn. @ 1 GHz	Power @ 1 GHz			
1 piece price shown. See web or call for volume pricing.				" dia.	12 dB/100ft	450 W
6"	12"	18"	24"	36"	48"	Custom Len.
\$131.05	\$134.97	\$139.01	\$134.87	\$151.13	\$149.95	See Web
PE-SR405FL Coax, 50 Ohm						
Part No. <a href="#">PE3C1377</a>	Cable Dia.	Attn. @ 1 GHz	Power @ 1 GHz			
1 piece price shown. See web or call for volume pricing.				" dia.	23 dB/100ft	130 W
6"	12"	18"	24"	36"	48"	Custom Len.
\$167.83	\$167.83	\$173.17	\$178.51	\$189.20	\$199.90	See Web
Standard Flexible Cable Assemblies						
PE-P086 Coax, 50 Ohm						
Part No. <a href="#">PE3C0666</a>	Cable Dia.	Attn. @ 1 GHz	Power @ 1 GHz			
1 piece price shown. See web or call for volume pricing.				0.104" dia.	23 dB/100ft	160 W
6"	12"	18"	24"	36"	48"	Custom Len.
\$161.97	\$165.82	\$169.79	\$173.76	\$181.70	\$190.11	See Web
PE-VNA-R Coax, 50 Ohm						
Part No. <a href="#">PE3VNA4001</a>	Cable Dia.	Attn. @ 1 GHz	Power @ 1 GHz			
1 piece price shown. See web or call for volume pricing.				0.430" dia.	dB/100ft	W
24"	36"	48"	60"	-	-	Custom Len.
\$1,925.46	\$2,040.47	\$2,128.65	\$2,243.59	-	-	See Web
Standard Semi-Rigid Cable Assemblies						
PE-118SR Coax, 50 Ohm						
Part No. <a href="#">PE3W07491</a>	Cable Dia.	Attn. @ 1 GHz	Power @ 1 GHz			
1 piece price shown. See web or call for volume pricing.				" dia.	13 dB/100ft	500 W
6"	12"	18"	24"	36"	48"	Custom Len.
\$286.40	\$286.40	\$288.20	\$290.00	\$293.59	\$297.19	See Web
PE-SR405FL Coax, 50 Ohm						
Part No. <a href="#">PE34739</a>	Cable Dia.	Attn. @ 1 GHz	Power @ 1 GHz			
1 piece price shown. See web or call for volume pricing.				" dia.	13 dB/100ft	500 W
6"	12"	18"	24"	36"	48"	Custom Len.
\$179.26	\$200.81	\$223.01	\$245.21	\$267.06	\$304.05	See Web
PE-SR402AL Coax, 50 Ohm						
Part No. <a href="#">PE34731</a>	Cable Dia.	Attn. @ 1 GHz	Power @ 1 GHz			
1 piece price shown. See web or call for volume pricing.				0.141" dia.	13 dB/100ft	450 W
6"	12"	18"	24"	36"	48"	Custom Len.
\$132.10	\$129.28	\$133.99	\$147.22	\$148.11	\$157.52	See Web
RG402/U Coax, 50 Ohm						

Cable Assemblies

See Our Website For Current Pricing & Real-Time Stock Availability!

Continued on Next Page

For Custom Lengths, Metric Lengths or Special Configurations, Please call (949) 261-1920

Technical Support  
+1 (949) 261-1920

Same-Day Shipping,  
Even Custom Cable Assemblies

For our complete selection of cable assemblies, please visit our website

Part No.	Cable Dia.				Attn. @ 1 GHz	Power @ 1 GHz
Part No. <a href="#">PE34729</a>	1 piece price shown. See web or call for volume pricing.				" dia.	12 dB/100ft
6"	12"	18"	24"	36"	48"	Custom Len.
\$130.97	\$134.76	\$138.68	\$142.58	\$150.41	\$149.04	See Web
<b>Skew Matched Pair Flexible Cable Assemblies</b>						
<b>PE-125LLS Coax, 50 Ohm</b>						
Part No. <a href="#">PE3C4680</a>	1 piece price shown. See web or call for volume pricing.				0.124" dia.	dB/100ft
12"	24"	48"	-	-	-	Custom Len.
\$1,152.59	\$1,277.05	\$1,525.96	-	-	-	See Web
<b>2.92MM MALE TO 2.92MM FEMALE</b>						
<b>Test Flexible Cable Assemblies</b>						
<b>PE-P160 Coax, 50 Ohm</b>						
Part No. <a href="#">PE361</a>	1 piece price shown. See web or call for volume pricing.				0.160" dia.	13 dB/100ft
36"	48"	100CM	150CM	200CM	12"	Custom Len.
\$319.65	\$345.54	\$326.92	\$369.41	\$411.87	\$267.86	See Web
<b>Standard Flexible Cable Assemblies</b>						
<b>PE-VNA-R Coax, 50 Ohm</b>						
Part No. <a href="#">PE3VNA4002</a>	1 piece price shown. See web or call for volume pricing.				0.430" dia.	dB/100ft
24"	48"	-	-	-	-	Custom Len.
\$1,987.98	\$2,191.17	-	-	-	-	See Web
Part No. <a href="#">PE3VNA2606</a>	1 piece price shown. See web or call for volume pricing.				0.430" dia.	dB/100ft
24"	48"	-	-	-	-	Custom Len.
\$1,521.23	\$1,714.76	-	-	-	-	See Web
<b>2.92MM MALE TO 2.92MM FEMALE BULKHEAD</b>						
SEE MOUNTING HOLE SECTION ON PAGE 369						
<b>Standard Formable Cable Assemblies</b>						
<b>PE-SR402FL Coax, 50 Ohm</b>						
Part No. <a href="#">PE34745</a>	1 piece price shown. See web or call for volume pricing.				" dia.	12 dB/100ft
6"	12"	18"	24"	36"	48"	Custom Len.
\$202.71	\$202.71	\$206.47	\$210.25	\$217.78	\$225.33	See Web
<b>Standard Semi-Rigid Cable Assemblies</b>						
<b>PE-SR402AL Coax, 50 Ohm</b>						
Part No. <a href="#">PE34743</a>	1 piece price shown. See web or call for volume pricing.				0.141" dia.	13 dB/100ft
6"	12"	18"	24"	36"	48"	Custom Len.
\$220.13	\$204.61	\$230.16	\$235.25	\$223.44	\$232.85	See Web
<b>RG402/U Coax, 50 Ohm</b>						
Part No. <a href="#">PE34741</a>	1 piece price shown. See web or call for volume pricing.				" dia.	12 dB/100ft
6"	12"	18"	24"	36"	48"	Custom Len.
\$210.81	\$214.61	\$218.52	\$209.76	\$217.07	\$224.37	See Web
<b>3.5MM MALE TO 3.5MM MALE</b>						
<b>Test Flexible Cable Assemblies</b>						
<b>PE-P160 Coax, 50 Ohm</b>						
Part No. <a href="#">PE369</a>	1 piece price shown. See web or call for volume pricing.				0.160" dia.	13 dB/100ft
36"	48"	60"	100CM	150CM	-	Custom Len.
\$308.01	\$333.91	\$359.81	\$315.29	\$357.77	-	See Web
<b>PE-VNA Coax, 50 Ohm</b>						
Part No. <a href="#">PE315</a>	1 piece price shown. See web or call for volume pricing.				" dia.	dB/100ft
24"	36"	48"	60"	72"	-	Custom Len.
\$942.75	\$1,142.61	\$1,137.86	\$1,334.42	\$1,459.35	-	See Web
<b>Standard Flexible Cable Assemblies</b>						
<b>PE-VNA-R Coax, 50 Ohm</b>						
Part No. <a href="#">PE3VNA2603</a>	1 piece price shown. See web or call for volume pricing.				0.430" dia.	dB/100ft
24"	36"	48"	60"	-	-	Custom Len.
\$1,461.69	\$1,710.94	\$1,655.21	\$1,921.98	-	-	See Web
<b>Standard Semi-Rigid Cable Assemblies</b>						
<b>PE-SR402AL Coax, 50 Ohm</b>						
Part No. <a href="#">PE34572</a>	1 piece price shown. See web or call for volume pricing.				0.141" dia.	13 dB/100ft
6"	12"	18"	24"	36"	48"	Custom Len.
\$223.69	\$228.63	\$233.71	\$238.80	\$248.99	\$243.93	See Web







Part No.	Cable Dia.				Attn. @ 1 GHz	Power @ 1 GHz
Part No. <a href="#">PE34576</a>	1 piece price shown. See web or call for volume pricing.				" dia.	23 dB/100ft
6"	12"	18"	24"	36"	48"	Custom Len.
\$225.05	\$225.05	\$229.36	\$233.68	\$242.34	\$250.97	See Web
<b>RG402/U Coax, 50 Ohm</b>						
Part No. <a href="#">PE34570</a>	1 piece price shown. See web or call for volume pricing.				" dia.	12 dB/100ft
6"	12"	18"	24"	36"	48"	Custom Len.
\$213.54	\$213.54	\$217.18	\$220.84	\$228.14	\$235.45	See Web
<b>RG405/U Coax, 50 Ohm</b>						
Part No. <a href="#">PE34574</a>	1 piece price shown. See web or call for volume pricing.				" dia.	22 dB/100ft
6"	12"	18"	24"	36"	48"	Custom Len.
\$223.27	\$223.27	\$226.70	\$230.13	\$237.01	\$259.38	See Web
<b>3.5MM MALE TO 3.5MM FEMALE</b>						
<b>Test Flexible Cable Assemblies</b>						
<b>PE-VNA Coax, 50 Ohm</b>						
Part No. <a href="#">PE317</a>	1 piece price shown. See web or call for volume pricing.				" dia.	dB/100ft
24"	36"	48"	60"	72"	-	Custom Len.
\$1,019.12	\$1,090.09	\$1,310.54	\$1,274.32	\$1,429.02	-	See Web
<b>Standard Formable Cable Assemblies</b>						
<b>PE-SR402FL Coax, 50 Ohm</b>						
Part No. <a href="#">PE3W03922</a>	1 piece price shown. See web or call for volume pricing.				" dia.	12 dB/100ft
12"	24"	36"	48"	60"	50CM	Custom Len.
\$191.04	\$198.89	\$206.73	\$214.57	\$222.42	\$196.07	See Web
<b>Standard Flexible Cable Assemblies</b>						
<b>PE-FF430 Coax, 50 Ohm</b>						
Part No. <a href="#">PE3C4012</a>	1 piece price shown. See web or call for volume pricing.				0.430" dia.	dB/100ft
100CM	-	-	-	-	-	Custom Len.
\$872.15	-	-	-	-	-	See Web
<b>PE-VNA-R Coax, 50 Ohm</b>						
Part No. <a href="#">PE3VNA2604</a>	1 piece price shown. See web or call for volume pricing.				0.430" dia.	dB/100ft
24"	36"	48"	60"	-	-	Custom Len.
\$1,491.45	\$1,743.41	\$1,684.98	\$1,954.45	-	-	See Web
<b>Standard Semi-Rigid Cable Assemblies</b>						
<b>PE-SR402AL Coax, 50 Ohm</b>						
Part No. <a href="#">PE34580</a>	1 piece price shown. See web or call for volume pricing.				0.141" dia.	13 dB/100ft
6"	12"	18"	24"	36"	48"	Custom Len.
\$220.79	\$220.79	\$225.48	\$230.20	\$239.60	\$265.16	See Web
<b>PE-SR405AL Coax, 50 Ohm</b>						
Part No. <a href="#">PE34584</a>	1 piece price shown. See web or call for volume pricing.				" dia.	23 dB/100ft
12"	24"	36"	48"	60"	-	Custom Len.
\$275.72	\$284.08	\$292.47	\$300.83	\$309.23	-	See Web
<b>RG402/U Coax, 50 Ohm</b>						
Part No. <a href="#">PE34578</a>	1 piece price shown. See web or call for volume pricing.				" dia.	12 dB/100ft
6"	12"	18"	24"	36"	48"	Custom Len.
\$227.95	\$218.63	\$222.28	\$225.93	\$233.23	\$240.54	See Web
<b>RG405/U Coax, 50 Ohm</b>						
Part No. <a href="#">PE34582</a>	1 piece price shown. See web or call for volume pricing.				" dia.	22 dB/100ft
6"	12"	18"	24"	36"	48"	Custom Len.
\$290.43	\$290.43	\$293.87	\$297.30	\$304.17	\$330.57	See Web
<b>3.5MM MALE TO 3.5MM FEMALE BULKHEAD</b>						
SEE MOUNTING HOLE SECTION ON PAGE 369						
<b>Standard Semi-Rigid Cable Assemblies</b>						
<b>PE-SR405AL Coax, 50 Ohm</b>						
Part No. <a href="#">PE34592</a>	1 piece price shown. See web or call for volume pricing.				" dia.	23 dB/100ft
6"	12"	18"	24"	36"	48"	Custom Len.
\$233.54	\$237.69	\$241.89	\$246.09	\$254.44	\$262.84	See Web
<b>3.5MM FEMALE TO 3.5MM FEMALE</b>						
<b>Standard Flexible Cable Assemblies</b>						
<b>PE-FF430 Coax, 50 Ohm</b>						
Part No. <a href="#">PE3C4013</a>	1 piece price shown. See web or call for volume pricing.				0.430" dia.	dB/100ft
100CM	-	-	-	-	-	Custom Len.
\$872.15	-	-	-	-	-	See Web









Cable Assemblies

See Our Website For Current Pricing & Real-Time Stock Availability!

\*Coax Performance at 1 GHz Notes: Cable assembly max frequency may be lower than connector or coax max frequency

For our complete selection of cable assemblies, please visit our website

<b>3.5MM FEMALE TO 3.5MM NMD FEMALE</b>					
<b>Standard Flexible Cable Assemblies</b>					
<b>PE-VNA-R Coax, 50 Ohm</b>					
Part No. <a href="#">PE3VNA2610</a>		Cable Dia.	Attn. @ 1 GHz	Power @ 1 GHz	68
1 piece price shown. See web or call for volume pricing.		0.430" dia.	dB/100ft	W	
24"	36"	48"	-	Custom Len.	
\$1,730.42	\$1,831.07	\$1,931.73	-	See Web	
<b>3.5MM NMD FEMALE TO 3.5MM MALE</b>					
<b>Standard Flexible Cable Assemblies</b>					
<b>PE-VNA-R Coax, 50 Ohm</b>					
Part No. <a href="#">PE3VNA2607</a>		Cable Dia.	Attn. @ 1 GHz	Power @ 1 GHz	69
1 piece price shown. See web or call for volume pricing.		0.430" dia.	dB/100ft	W	
24"	36"	48"	-	Custom Len.	
\$1,697.95	\$1,798.60	\$1,899.26	-	See Web	
<b>4.1/9.5 MINI DIN MALE TO 4.1/9.5 MINI DIN MALE</b>					
<b>Corrugated Cable Assemblies</b>					
<b>SPP-250-LLPL Coax, 50 Ohm</b>					
Part No. <a href="#">PE3C4143</a>		Cable Dia.	Attn. @ 1 GHz	Power @ 1 GHz	70
1 piece price shown. See web or call for volume pricing.		0.280" dia.	6 dB/100ft	650 W	
12"	24"	36"	48"	60"	
\$92.38	\$97.96	\$103.54	\$109.12	\$114.70	
<b>Low PIM Formable Cable Assemblies</b>					
<b>PE-SR402FLJ Low PIM Coax, 50 Ohm</b>					
Part No. <a href="#">PE3C2009</a>		Cable Dia.	Attn. @ 1 GHz	Power @ 1 GHz	71
1 piece price shown. See web or call for volume pricing.		0.161" dia.	dB/100ft	W	
100CM	200CM	-	-	Custom Len.	
\$103.67	\$124.11	-	-	See Web	
<b>4.1/9.5 MINI DIN MALE TO 4.1/9.5 MINI DIN MALE RIGHT ANGLE</b>					
<b>Low PIM Corrugated Cable Assemblies</b>					
<b>SPP-250-LLPL Coax, 50 Ohm</b>					
Part No. <a href="#">PE3C5847</a>		Cable Dia.	Attn. @ 1 GHz	Power @ 1 GHz	72
1 piece price shown. See web or call for volume pricing.		0.280" dia.	dB/100ft	W	
12"	24"	36"	48"	60"	
\$97.08	\$102.66	\$108.24	\$113.82	\$119.40	
<b>4.1/9.5 MINI DIN MALE TO 4.1/9.5 MINI DIN FEMALE</b>					
<b>Low PIM Formable Cable Assemblies</b>					
<b>PE-SR402FLJ Low PIM Coax, 50 Ohm</b>					
Part No. <a href="#">PE3C2010</a>		Cable Dia.	Attn. @ 1 GHz	Power @ 1 GHz	73
1 piece price shown. See web or call for volume pricing.		0.161" dia.	dB/100ft	W	
100CM	200CM	-	-	Custom Len.	
\$127.25	\$134.05	-	-	See Web	
<b>4.1/9.5 MINI DIN MALE TO 4.3-10 FEMALE</b>					
<b>Low PIM Corrugated Cable Assemblies</b>					
<b>SPP-250-LLPL Coax, 50 Ohm</b>					
Part No. <a href="#">PE3C5841</a>		Cable Dia.	Attn. @ 1 GHz	Power @ 1 GHz	74
1 piece price shown. See web or call for volume pricing.		0.280" dia.	dB/100ft	W	
12"	24"	36"	48"	60"	
\$89.85	\$95.43	\$101.01	\$106.59	\$112.17	
<b>4.1/9.5 MINI DIN MALE TO 7/16 DIN MALE</b>					
<b>Low PIM Corrugated Cable Assemblies</b>					
<b>SPP-250-LLPL Coax, 50 Ohm</b>					
Part No. <a href="#">PE3C5834</a>		Cable Dia.	Attn. @ 1 GHz	Power @ 1 GHz	75
1 piece price shown. See web or call for volume pricing.		0.280" dia.	dB/100ft	W	
12"	24"	36"	48"	60"	
\$89.85	\$95.43	\$101.01	\$106.59	\$112.17	

Part No. <a href="#">PE3C4134</a>		Cable Dia.	Attn. @ 1 GHz	Power @ 1 GHz	76
1 piece price shown. See web or call for volume pricing.		0.280" dia.	dB/100ft	W	
12"	24"	36"	48"	60"	
\$94.72	\$100.29	\$105.87	\$111.45	\$117.03	
<b>4.1/9.5 MINI DIN MALE TO 7/16 DIN FEMALE</b>					
<b>Low PIM Corrugated Cable Assemblies</b>					
<b>SPP-250-LLPL Coax, 50 Ohm</b>					
Part No. <a href="#">PE3C5854</a>		Cable Dia.	Attn. @ 1 GHz	Power @ 1 GHz	77
1 piece price shown. See web or call for volume pricing.		0.280" dia.	dB/100ft	W	
12"	24"	36"	48"	60"	
\$89.85	\$95.43	\$101.01	\$106.59	\$112.17	
<b>4.1/9.5 MINI DIN MALE TO QMA MALE</b>					
<b>Low PIM Corrugated Cable Assemblies</b>					
<b>SPP-250-LLPL Coax, 50 Ohm</b>					
Part No. <a href="#">PE3C5866</a>		Cable Dia.	Attn. @ 1 GHz	Power @ 1 GHz	78
1 piece price shown. See web or call for volume pricing.		0.280" dia.	dB/100ft	W	
12"	24"	36"	48"	60"	
\$79.03	\$84.61	\$90.19	\$95.76	\$101.34	
<b>4.1/9.5 MINI DIN MALE TO QMA MALE RIGHT ANGLE</b>					
<b>Low PIM Corrugated Cable Assemblies</b>					
<b>SPP-250-LLPL Coax, 50 Ohm</b>					
Part No. <a href="#">PE3C5872</a>		Cable Dia.	Attn. @ 1 GHz	Power @ 1 GHz	79
1 piece price shown. See web or call for volume pricing.		0.280" dia.	dB/100ft	W	
12"	24"	36"	48"	60"	
\$81.20	\$86.78	\$92.36	\$97.94	\$103.52	
<b>4.1/9.5 MINI DIN MALE TO QMA FEMALE</b>					
<b>Low PIM Corrugated Cable Assemblies</b>					
<b>SPP-250-LLPL Coax, 50 Ohm</b>					
Part No. <a href="#">PE3C5860</a>		Cable Dia.	Attn. @ 1 GHz	Power @ 1 GHz	80
1 piece price shown. See web or call for volume pricing.		0.280" dia.	dB/100ft	W	
12"	24"	36"	48"	60"	
\$75.43	\$81.01	\$86.59	\$92.17	\$97.75	
<b>4.1/9.5 MINI DIN MALE TO SMA MALE</b>					
<b>Low PIM Corrugated Cable Assemblies</b>					
<b>SPP-250-LLPL Coax, 50 Ohm</b>					
Part No. <a href="#">PE3C5885</a>		Cable Dia.	Attn. @ 1 GHz	Power @ 1 GHz	81
1 piece price shown. See web or call for volume pricing.		0.280" dia.	dB/100ft	W	
12"	24"	36"	48"	60"	
\$71.81	\$77.38	\$82.96	\$88.54	\$94.12	
<b>4.1/9.5 MINI DIN MALE TO SMA MALE RIGHT ANGLE</b>					
<b>Low PIM Corrugated Cable Assemblies</b>					
<b>SPP-250-LLPL Coax, 50 Ohm</b>					
Part No. <a href="#">PE3C5890</a>		Cable Dia.	Attn. @ 1 GHz	Power @ 1 GHz	82
1 piece price shown. See web or call for volume pricing.		0.280" dia.	dB/100ft	W	
12"	24"	36"	48"	60"	
\$73.26	\$78.84	\$84.42	\$90.00	\$95.58	
<b>4.1/9.5 MINI DIN MALE TO SMA FEMALE</b>					
<b>Low PIM Corrugated Cable Assemblies</b>					
<b>SPP-250-LLPL Coax, 50 Ohm</b>					
Part No. <a href="#">PE3C5879</a>		Cable Dia.	Attn. @ 1 GHz	Power @ 1 GHz	83
1 piece price shown. See web or call for volume pricing.		0.280" dia.	dB/100ft	W	
12"	24"	36"	48"	60"	
\$72.53	\$78.11	\$83.69	\$89.27	\$94.85	
<b>4.1/9.5 MINI DIN MALE RIGHT ANGLE TO 4.1/9.5 MINI DIN MALE RIGHT ANGLE</b>					
<b>Low PIM Corrugated Cable Assemblies</b>					

Cable Assemblies

See Our Website For Current Pricing & Real-Time Stock Availability!

Continued on Next Page

For Custom Lengths, Metric Lengths or Special Configurations, Please call (949) 261-1920



Technical Support  
+1 (949) 261-1920



Same-Day Shipping,  
Even Custom Cable Assemblies

For our complete selection of cable assemblies, please visit our website

Cable Assemblies

See Our Website For Current Pricing & Real-Time Stock Availability!

SPP-250-LLPL Coax, 50 Ohm						
Part No. <a href="#">PE3C5852</a>	Cable Dia.			Attn. @ 1 GHz	Power @ 1 GHz	
1 piece price shown. See web or call for volume pricing.						
12"	24"	36"	48"	0.280" dia.	dB/100ft	W
				60"	50CM	Custom Len.
\$107.91	\$113.49	\$119.07	\$124.65	\$130.23	\$111.48	See Web

**4.1/9.5 MINI DIN MALE RIGHT ANGLE TO 4.3-10 MALE**



Low PIM Corrugated Cable Assemblies

SPP-250-LLPL Coax, 50 Ohm						
Part No. <a href="#">PE3C5846</a>	Cable Dia.			Attn. @ 1 GHz	Power @ 1 GHz	
1 piece price shown. See web or call for volume pricing.						
12"	24"	36"	48"	0.280" dia.	dB/100ft	W
				60"	50CM	Custom Len.
\$97.08	\$102.66	\$108.24	\$113.82	\$119.40	\$100.66	See Web

**4.1/9.5 MINI DIN MALE RIGHT ANGLE TO 4.3-10 FEMALE**



Corrugated Cable Assemblies

SPP-250-LLPL Coax, 50 Ohm						
Part No. <a href="#">PE3C5950</a>	Cable Dia.			Attn. @ 1 GHz	Power @ 1 GHz	
1 piece price shown. See web or call for volume pricing.						
12"	24"	36"	48"	0.280" dia.	dB/100ft	W
				60"	50CM	Custom Len.
\$100.68	\$106.26	\$111.84	\$117.42	\$123.00	\$104.24	See Web

**4.1/9.5 MINI DIN MALE RIGHT ANGLE TO 7/16 DIN MALE**



Low PIM Corrugated Cable Assemblies

SPP-250-LLPL Coax, 50 Ohm						
Part No. <a href="#">PE3C5848</a>	Cable Dia.			Attn. @ 1 GHz	Power @ 1 GHz	
1 piece price shown. See web or call for volume pricing.						
12"	24"	36"	48"	0.280" dia.	dB/100ft	W
				60"	50CM	Custom Len.
\$100.68	\$106.26	\$111.84	\$117.42	\$123.00	\$104.25	See Web

**4.1/9.5 MINI DIN MALE RIGHT ANGLE TO N MALE**



Low PIM Corrugated Cable Assemblies

SPP-250-LLPL Coax, 50 Ohm						
Part No. <a href="#">PE3C5849</a>	Cable Dia.			Attn. @ 1 GHz	Power @ 1 GHz	
1 piece price shown. See web or call for volume pricing.						
12"	24"	36"	48"	0.280" dia.	dB/100ft	W
				60"	50CM	Custom Len.
\$93.46	\$99.04	\$104.62	\$110.20	\$115.78	\$97.03	See Web

**4.1/9.5 MINI DIN MALE RIGHT ANGLE TO QMA MALE**



Low PIM Corrugated Cable Assemblies

SPP-250-LLPL Coax, 50 Ohm						
Part No. <a href="#">PE3C5850</a>	Cable Dia.			Attn. @ 1 GHz	Power @ 1 GHz	
1 piece price shown. See web or call for volume pricing.						
12"	24"	36"	48"	0.280" dia.	dB/100ft	W
				60"	50CM	Custom Len.
\$89.85	\$95.43	\$101.01	\$106.59	\$112.17	\$93.43	See Web

**4.1/9.5 MINI DIN MALE RIGHT ANGLE TO SMA MALE**



Low PIM Corrugated Cable Assemblies

SPP-250-LLPL Coax, 50 Ohm						
Part No. <a href="#">PE3C5851</a>	Cable Dia.			Attn. @ 1 GHz	Power @ 1 GHz	
1 piece price shown. See web or call for volume pricing.						
12"	24"	36"	48"	0.280" dia.	dB/100ft	W
				60"	50CM	Custom Len.
\$82.63	\$88.21	\$93.79	\$99.37	\$104.95	\$86.21	See Web

**4.1/9.5 MINI DIN FEMALE TO 4.3-10 MALE**



Low PIM Corrugated Cable Assemblies

SPP-250-LLPL Coax, 50 Ohm						
Part No. <a href="#">PE3C5840</a>	Cable Dia.			Attn. @ 1 GHz	Power @ 1 GHz	
1 piece price shown. See web or call for volume pricing.						
12"	24"	36"	48"	0.280" dia.	dB/100ft	W
				60"	50CM	Custom Len.
\$89.85	\$95.43	\$101.01	\$106.59	\$112.17	\$93.43	See Web

**4.1/9.5 MINI DIN FEMALE TO 7/16 DIN MALE**



Low PIM Corrugated Cable Assemblies

SPP-250-LLPL Coax, 50 Ohm						
Part No. <a href="#">PE3C5842</a>	Cable Dia.			Attn. @ 1 GHz	Power @ 1 GHz	
1 piece price shown. See web or call for volume pricing.						
12"	24"	36"	48"	0.280" dia.	dB/100ft	W
				60"	50CM	Custom Len.
\$93.45	\$99.03	\$104.61	\$110.19	\$115.77	\$97.02	See Web

**4.1/9.5 MINI DIN FEMALE TO N MALE**



Low PIM Corrugated Cable Assemblies

SPP-250-LLPL Coax, 50 Ohm						
Part No. <a href="#">PE3C5843</a>	Cable Dia.			Attn. @ 1 GHz	Power @ 1 GHz	
1 piece price shown. See web or call for volume pricing.						
12"	24"	36"	48"	0.280" dia.	dB/100ft	W
				60"	50CM	Custom Len.
\$86.23	\$91.81	\$97.39	\$102.96	\$108.54	\$89.80	See Web

**4.1/9.5 MINI DIN FEMALE TO QMA MALE**



Low PIM Corrugated Cable Assemblies

SPP-250-LLPL Coax, 50 Ohm						
Part No. <a href="#">PE3C5844</a>	Cable Dia.			Attn. @ 1 GHz	Power @ 1 GHz	
1 piece price shown. See web or call for volume pricing.						
12"	24"	36"	48"	0.280" dia.	dB/100ft	W
				60"	50CM	Custom Len.
\$82.62	\$88.20	\$93.78	\$99.36	\$104.94	\$86.20	See Web

**4.1/9.5 MINI DIN FEMALE TO SMA MALE**



Low PIM Corrugated Cable Assemblies

SPP-250-LLPL Coax, 50 Ohm						
Part No. <a href="#">PE3C5845</a>	Cable Dia.			Attn. @ 1 GHz	Power @ 1 GHz	
1 piece price shown. See web or call for volume pricing.						
12"	24"	36"	48"	0.280" dia.	dB/100ft	W
				60"	50CM	Custom Len.
\$75.40	\$80.98	\$86.56	\$92.14	\$97.72	\$78.97	See Web

**4.3-10 MALE TO 4.3-10 MALE**



Low PIM Corrugated Cable Assemblies

SPP-250-LLPL Coax, 50 Ohm						
Part No. <a href="#">PE3C4142</a>	Cable Dia.			Attn. @ 1 GHz	Power @ 1 GHz	
1 piece price shown. See web or call for volume pricing.						
12"	24"	36"	48"	0.280" dia.	dB/100ft	W
				60"	50CM	Custom Len.
\$92.38	\$97.96	\$103.54	\$109.12	\$114.70	\$95.95	See Web

**4.3-10 MALE TO 4.3-10 FEMALE**



Low PIM Corrugated Cable Assemblies

SPP-250-LLPL Coax, 50 Ohm						
Part No. <a href="#">PE3C5833</a>	Cable Dia.			Attn. @ 1 GHz	Power @ 1 GHz	
1 piece price shown. See web or call for volume pricing.						
12"	24"	36"	48"	0.280" dia.	dB/100ft	W
				60"	50CM	Custom Len.
\$89.85	\$95.43	\$101.01	\$106.59	\$112.17	\$93.43	See Web

**4.3-10 MALE TO 7/16 DIN MALE**



Low PIM Corrugated Cable Assemblies

SPP-250-LLPL Coax, 50 Ohm						
Part No. <a href="#">PE3C4135</a>	Cable Dia.			Attn. @ 1 GHz	Power @ 1 GHz	
1 piece price shown. See web or call for volume pricing.						
12"	24"	36"	48"	0.280" dia.	6 dB/100ft	650 W
				60"	50CM	Custom Len.
\$94.72	\$100.29	\$105.87	\$111.45	\$117.03	\$98.29	See Web

**4.3-10 MALE TO 7/16 DIN FEMALE**



Low PIM Corrugated Cable Assemblies

SPP-250-LLPL Coax, 50 Ohm						
Part No. <a href="#">PE3C5853</a>	Cable Dia.			Attn. @ 1 GHz	Power @ 1 GHz	
1 piece price shown. See web or call for volume pricing.						
12"	24"	36"	48"	0.280" dia.	dB/100ft	W
				60"	50CM	Custom Len.
\$89.85	\$95.43	\$101.01	\$106.59	\$112.17	\$93.43	See Web

**4.3-10 MALE TO N MALE**



Corrugated Cable Assemblies

\*Coax Performance at 1 GHz Notes: Cable assembly max frequency may be lower than connector or coax max frequency



For our complete selection of cable assemblies, please visit our website

SPP-250-LLPL Coax, 50 Ohm						
Part No. <a href="#">PE3C4141</a>	Cable Dia.			Attn. @ 1 GHz	Power @ 1 GHz	
1 piece price shown. See web or call for volume pricing.						
12"	24"	36"	48"	60"	50CM	Custom Len.
\$90.05	\$95.63	\$101.21	\$106.79	\$112.37	\$93.62	See Web

**4.3-10 MALE TO QMA MALE**



**Corrugated Cable Assemblies**

SPP-250-LLPL Coax, 50 Ohm						
Part No. <a href="#">PE3C5865</a>	Cable Dia.			Attn. @ 1 GHz	Power @ 1 GHz	
1 piece price shown. See web or call for volume pricing.						
12"	24"	36"	48"	60"	50CM	Custom Len.
\$79.03	\$84.61	\$90.19	\$95.76	\$101.34	\$82.60	See Web

**4.3-10 MALE TO QMA MALE RIGHT ANGLE**



**Corrugated Cable Assemblies**

SPP-250-LLPL Coax, 50 Ohm						
Part No. <a href="#">PE3C5871</a>	Cable Dia.			Attn. @ 1 GHz	Power @ 1 GHz	
1 piece price shown. See web or call for volume pricing.						
12"	24"	36"	48"	60"	50CM	Custom Len.
\$81.20	\$86.78	\$92.36	\$97.94	\$103.52	\$84.77	See Web

**4.3-10 MALE TO QMA FEMALE**



**Low PIM Corrugated Cable Assemblies**

SPP-250-LLPL Coax, 50 Ohm						
Part No. <a href="#">PE3C5859</a>	Cable Dia.			Attn. @ 1 GHz	Power @ 1 GHz	
1 piece price shown. See web or call for volume pricing.						
12"	24"	36"	48"	60"	50CM	Custom Len.
\$75.43	\$81.01	\$86.59	\$92.17	\$97.75	\$79.01	See Web

**4.3-10 MALE TO SMA MALE**



**Low PIM Corrugated Cable Assemblies**

SPP-250-LLPL Coax, 50 Ohm						
Part No. <a href="#">PE3C5884</a>	Cable Dia.			Attn. @ 1 GHz	Power @ 1 GHz	
1 piece price shown. See web or call for volume pricing.						
12"	24"	36"	48"	60"	50CM	Custom Len.
\$71.81	\$77.38	\$82.96	\$88.54	\$94.12	\$75.38	See Web

**4.3-10 MALE TO SMA MALE RIGHT ANGLE**



**Corrugated Cable Assemblies**

SPP-250-LLPL Coax, 50 Ohm						
Part No. <a href="#">PE3C5889</a>	Cable Dia.			Attn. @ 1 GHz	Power @ 1 GHz	
1 piece price shown. See web or call for volume pricing.						
12"	24"	36"	48"	60"	50CM	Custom Len.
\$73.26	\$78.84	\$84.42	\$90.00	\$95.58	\$76.83	See Web

**4.3-10 MALE TO SMA FEMALE**



**Corrugated Cable Assemblies**

SPP-250-LLPL Coax, 50 Ohm						
Part No. <a href="#">PE3C5878</a>	Cable Dia.			Attn. @ 1 GHz	Power @ 1 GHz	
1 piece price shown. See web or call for volume pricing.						
12"	24"	36"	48"	60"	50CM	Custom Len.
\$72.53	\$78.11	\$83.69	\$89.27	\$94.85	\$76.11	See Web

**4.3-10 MALE RIGHT ANGLE TO 4.3-10 MALE**



**Low PIM Corrugated Cable Assemblies**

SPP-250-LLPL Coax, 50 Ohm						
Part No. <a href="#">PE3C4147</a>	Cable Dia.			Attn. @ 1 GHz	Power @ 1 GHz	
1 piece price shown. See web or call for volume pricing.						
12"	24"	36"	48"	60"	50CM	Custom Len.
\$99.40	\$104.98	\$110.56	\$116.14	\$121.72	\$102.98	See Web

**4.3-10 MALE RIGHT ANGLE TO 4.3-10 MALE RIGHT ANGLE**



**Low PIM Corrugated Cable Assemblies**

SPP-250-LLPL Coax, 50 Ohm						
Part No. <a href="#">PE3C4146</a>	Cable Dia.			Attn. @ 1 GHz	Power @ 1 GHz	
1 piece price shown. See web or call for volume pricing.						
12"	24"	36"	48"	60"	50CM	Custom Len.
\$106.41	\$111.99	\$117.57	\$123.15	\$128.73	\$109.99	See Web

**4.3-10 FEMALE TO N MALE**



**Low PIM Corrugated Cable Assemblies**

SPP-250-LLPL Coax, 50 Ohm						
Part No. <a href="#">PE3C5837</a>	Cable Dia.			Attn. @ 1 GHz	Power @ 1 GHz	
1 piece price shown. See web or call for volume pricing.						
12"	24"	36"	48"	60"	50CM	Custom Len.
\$86.23	\$91.81	\$97.39	\$102.96	\$108.54	\$89.80	See Web

**4.3-10 FEMALE TO QMA MALE**



**Corrugated Cable Assemblies**

SPP-250-LLPL Coax, 50 Ohm						
Part No. <a href="#">PE3C5838</a>	Cable Dia.			Attn. @ 1 GHz	Power @ 1 GHz	
1 piece price shown. See web or call for volume pricing.						
12"	24"	36"	48"	60"	50CM	Custom Len.
\$82.62	\$88.20	\$93.78	\$99.36	\$104.94	\$86.20	See Web

**4.3-10 FEMALE TO SMA MALE**



**Low PIM Corrugated Cable Assemblies**

SPP-250-LLPL Coax, 50 Ohm						
Part No. <a href="#">PE3C5839</a>	Cable Dia.			Attn. @ 1 GHz	Power @ 1 GHz	
1 piece price shown. See web or call for volume pricing.						
12"	24"	36"	48"	60"	50CM	Custom Len.
\$75.40	\$80.98	\$86.56	\$92.14	\$97.72	\$78.97	See Web

**7/16 DIN MALE TO 4.3-10 FEMALE**



**Corrugated Cable Assemblies**

SPP-250-LLPL Coax, 50 Ohm						
Part No. <a href="#">PE3C5836</a>	Cable Dia.			Attn. @ 1 GHz	Power @ 1 GHz	
1 piece price shown. See web or call for volume pricing.						
12"	24"	36"	48"	60"	50CM	Custom Len.
\$93.45	\$99.03	\$104.61	\$110.19	\$115.77	\$97.02	See Web

**7/16 DIN MALE TO 7/16 DIN MALE**



**Low Loss Formable Cable Assemblies**

LMR-SW396 Coax, 50 Ohm						
Part No. <a href="#">PE3C0138</a>	Cable Dia.			Attn. @ 1 GHz	Power @ 1 GHz	
1 piece price shown. See web or call for volume pricing.						
12"	24"	36"	48"	60"	-	Custom Len.
\$79.18	\$81.47	\$83.74	\$86.02	\$88.32	-	See Web

LMR-SW540 Coax, 50 Ohm						
Part No. <a href="#">PE3C0141</a>	Cable Dia.			Attn. @ 1 GHz	Power @ 1 GHz	
1 piece price shown. See web or call for volume pricing.						
12"	24"	36"	48"	60"	-	Custom Len.
\$84.20	\$86.81	\$94.48	\$92.02	\$99.90	-	See Web

**Low Loss Flexible Cable Assemblies**

PE-C195 Coax, 50 Ohm						
Part No. <a href="#">PE37952</a>	Cable Dia.			Attn. @ 1 GHz	Power @ 1 GHz	
1 piece price shown. See web or call for volume pricing.						
36"	48"	60"	72"	120"	-	Custom Len.
\$84.76	\$85.49	\$86.15	\$86.81	\$89.57	-	See Web

PE-C600 Coax, 50 Ohm						
Part No. <a href="#">PE37955</a>	Cable Dia.			Attn. @ 1 GHz	Power @ 1 GHz	
1 piece price shown. See web or call for volume pricing.						
36"	48"	60"	72"	120"	-	Custom Len.
\$169.97	\$162.83	\$165.32	\$167.78	\$177.69	-	See Web

LMR-400 Coax, 50 Ohm						
Part No. <a href="#">PE3W03530</a>	Cable Dia.			Attn. @ 1 GHz	Power @ 1 GHz	
1 piece price shown. See web or call for volume pricing.						
12"	24"	36"	48"	60"	50CM	Custom Len.
\$87.64	\$88.89	\$90.13	\$91.38	\$92.63	\$88.44	See Web

**Low PIM Formable Cable Assemblies**

PE-SR401FLJ Low PIM Coax, 50 Ohm

Cable Assemblies

See Our Website For Current Pricing & Real-Time Stock Availability!

Continued on Next Page

For Custom Lengths, Metric Lengths or Special Configurations, Please call (949) 261-1920



Technical Support  
+1 (949) 261-1920



Same-Day Shipping,  
Even Custom Cable Assemblies

For our complete selection of cable assemblies, please visit our website

Part No.	Cable Dia.				Attn. @ 1 GHz	Power @ 1 GHz
Part No. <b>PE3C2013</b>	1 piece price shown. See web or call for volume pricing.				0.276" dia.	dB/100ft W
100CM	200CM	-	-	-	-	Custom Len.
\$176.10	\$204.49	-	-	-	-	See Web
<b>PE-SR402FLJ Low PIM Coax, 50 Ohm</b>						
Part No. <b>PE3C2003</b>	1 piece price shown. See web or call for volume pricing.				0.161" dia.	dB/100ft W
100CM	200CM	-	-	-	-	Custom Len.
\$128.29	\$148.72	-	-	-	-	See Web
<b>Low PIM Corrugated Cable Assemblies</b>						
<b>SPP-250-LLPL Coax, 50 Ohm</b>						
Part No. <b>PE3C4130</b>	1 piece price shown. See web or call for volume pricing.				0.280" dia.	6 dB/100ft 650 W
12"	24"	36"	48"	60"	50CM	Custom Len.
\$97.05	\$102.63	\$108.21	\$113.79	\$119.37	\$100.35	See Web
<b>Standard Formable Cable Assemblies</b>						
<b>PE-SR401FL Coax, 50 Ohm</b>						
Part No. <b>PE36140</b>	1 piece price shown. See web or call for volume pricing.				" dia.	8 dB/100ft 1400 W
12"	24"	36"	48"	60"	72"	Custom Len.
\$309.11	\$324.05	\$339.00	\$353.95	\$368.87	\$383.82	See Web
<b>Standard Flexible Cable Assemblies</b>						
<b>RG58C/U Coax, 50 Ohm</b>						
Part No. <b>PE3183</b>	1 piece price shown. See web or call for volume pricing.				0.195" dia.	20 dB/100ft 44 W
12"	24"	36"	48"	60"	72"	Custom Len.
\$238.15	\$238.89	\$239.62	\$240.35	\$241.09	\$241.83	See Web
<b>RG142B/U Coax, 50 Ohm</b>						
Part No. <b>PE3189</b>	1 piece price shown. See web or call for volume pricing.				0.195" dia.	13 dB/100ft W
12"	24"	36"	48"	60"	72"	Custom Len.
\$105.52	\$111.26	\$116.98	\$122.72	\$128.45	\$134.18	See Web
<b>RG214/U Coax, 50 Ohm</b>						
Part No. <b>PE3185</b>	1 piece price shown. See web or call for volume pricing.				0.425" dia.	7 dB/100ft 170 W
12"	24"	36"	48"	60"	72"	Custom Len.
\$263.79	\$271.11	\$278.44	\$303.41	\$293.08	\$300.42	See Web
<b>RG217/U Coax, 50 Ohm</b>						
Part No. <b>PE36134</b>	1 piece price shown. See web or call for volume pricing.				0.545" dia.	6 dB/100ft 260 W
12"	24"	36"	48"	60"	72"	Custom Len.
\$319.51	\$323.92	\$328.32	\$332.73	\$337.12	\$341.53	See Web
<b>RG218/U Coax, 50 Ohm</b>						
Part No. <b>PE35900</b>	1 piece price shown. See web or call for volume pricing.				0.870" dia.	4 dB/100ft 560 W
12"	24"	36"	48"	60"	72"	Custom Len.
\$348.27	\$359.76	\$371.27	\$382.76	\$418.87	\$405.76	See Web
<b>RG393/U Coax, 50 Ohm</b>						
Part No. <b>PE3205</b>	1 piece price shown. See web or call for volume pricing.				0.390" dia.	8 dB/100ft 1700 W
12"	24"	36"	48"	60"	72"	Custom Len.
\$272.51	\$163.49	\$179.89	\$197.25	\$213.98	\$230.71	See Web
<b>RG400/U Coax, 50 Ohm</b>						
Part No. <b>PE34360</b>	1 piece price shown. See web or call for volume pricing.				0.195" dia.	15 dB/100ft 650 W
12"	24"	36"	48"	60"	72"	Custom Len.
\$107.05	\$114.05	\$121.06	\$128.10	\$135.12	\$142.14	See Web
<b>7/16 DIN MALE TO 7/16 DIN MALE RIGHT ANGLE</b>						
<b>Low Loss Flexible Cable Assemblies</b>						
<b>PE-C600 Coax, 50 Ohm</b>						
Part No. <b>PE37959</b>	1 piece price shown. See web or call for volume pricing.				0.590" dia.	3 dB/100ft 900 W
36"	48"	60"	72"	120"	-	Custom Len.
\$186.83	\$178.74	\$181.21	\$183.68	\$193.60	-	See Web
<b>Standard Flexible Cable Assemblies</b>						
<b>RG214/U Coax, 50 Ohm</b>						
Part No. <b>PE38584</b>	1 piece price shown. See web or call for volume pricing.				0.425" dia.	7 dB/100ft 190 W
12"	24"	36"	48"	60"	-	Custom Len.
\$285.67	\$293.00	\$300.32	\$307.65	\$314.97	-	See Web
<b>RG217/U Coax, 50 Ohm</b>						
Part No. <b>PE37600</b>	1 piece price shown. See web or call for volume pricing.				0.545" dia.	6 dB/100ft 260 W
12"	24"	36"	48"	60"	-	Custom Len.
\$357.82	\$362.23	\$366.63	\$371.04	\$398.54	-	See Web
<b>RG393/U Coax, 50 Ohm</b>						
Part No. <b>PE36657</b>	1 piece price shown. See web or call for volume pricing.				0.390" dia.	9 dB/100ft 1700 W
12"	24"	36"	48"	60"	-	Custom Len.
\$311.31	\$327.71	\$324.61	\$340.09	\$378.21	-	See Web

<b>7/16 DIN MALE TO 7/16 DIN FEMALE</b>						
<b>Low PIM Formable Cable Assemblies</b>						
<b>PE-SR401FLJ Low PIM Coax, 50 Ohm</b>						
Part No. <b>PE3C2015</b>	1 piece price shown. See web or call for volume pricing.				0.276" dia.	dB/100ft W
100CM	200CM	-	-	-	-	Custom Len.
\$176.10	\$204.49	-	-	-	-	See Web
<b>PE-SR402FLJ Low PIM Coax, 50 Ohm</b>						
Part No. <b>PE3C2004</b>	1 piece price shown. See web or call for volume pricing.				0.161" dia.	dB/100ft W
100CM	200CM	-	-	-	-	Custom Len.
\$113.44	\$121.71	-	-	-	-	See Web
<b>Low PIM Corrugated Cable Assemblies</b>						
<b>SPP-250-LLPL Coax, 50 Ohm</b>						
Part No. <b>PE3C5855</b>	1 piece price shown. See web or call for volume pricing.				0.280" dia.	dB/100ft W
12"	24"	36"	48"	60"	50CM	Custom Len.
\$93.45	\$99.03	\$104.61	\$110.19	\$115.77	\$97.02	See Web
<b>Standard Flexible Cable Assemblies</b>						
<b>RG393/U Coax, 50 Ohm</b>						
Part No. <b>PE37450</b>	1 piece price shown. See web or call for volume pricing.				0.390" dia.	9 dB/100ft 1700 W
12"	24"	36"	48"	60"	-	Custom Len.
\$282.36	\$297.82	\$313.29	\$328.76	\$366.20	-	See Web
<b>7/16 DIN MALE TO N MALE</b>						
<b>Low Loss Flexible Cable Assemblies</b>						
<b>LMR-400-UF Coax, 50 Ohm</b>						
Part No. <b>PE3W03271</b>	1 piece price shown. See web or call for volume pricing.				0.405" dia.	5 dB/100ft W
12"	24"	36"	48"	60"	50CM	Custom Len.
\$92.63	\$95.25	\$97.87	\$100.50	\$103.13	\$94.31	See Web
<b>Standard Semi-Rigid Cable Assemblies</b>						
<b>RG401/U Coax, 50 Ohm</b>						
Part No. <b>PE36174</b>	1 piece price shown. See web or call for volume pricing.				" dia.	8 dB/100ft 1400 W
12"	24"	36"	48"	60"	-	Custom Len.
\$220.58	\$241.89	\$263.20	\$284.45	\$305.76	-	See Web
<b>7/16 DIN MALE TO QMA MALE</b>						
<b>Low PIM Corrugated Cable Assemblies</b>						
<b>SPP-250-LLPL Coax, 50 Ohm</b>						
Part No. <b>PE3C5867</b>	1 piece price shown. See web or call for volume pricing.				0.280" dia.	dB/100ft W
12"	24"	36"	48"	60"	50CM	Custom Len.
\$82.62	\$88.20	\$93.78	\$99.36	\$104.94	\$86.20	See Web
<b>7/16 DIN MALE TO QMA MALE RIGHT ANGLE</b>						
<b>Low PIM Corrugated Cable Assemblies</b>						
<b>SPP-250-LLPL Coax, 50 Ohm</b>						
Part No. <b>PE3C5873</b>	1 piece price shown. See web or call for volume pricing.				0.280" dia.	dB/100ft W
12"	24"	36"	48"	60"	50CM	Custom Len.
\$84.79	\$90.37	\$95.95	\$101.53	\$107.11	\$88.37	See Web
<b>7/16 DIN MALE TO QMA FEMALE</b>						
<b>Low PIM Corrugated Cable Assemblies</b>						
<b>SPP-250-LLPL Coax, 50 Ohm</b>						
Part No. <b>PE3C5861</b>	1 piece price shown. See web or call for volume pricing.				0.280" dia.	dB/100ft W
12"	24"	36"	48"	60"	50CM	Custom Len.
\$79.03	\$84.61	\$90.19	\$95.76	\$101.34	\$82.60	See Web
<b>7/16 DIN MALE TO SC MALE</b>						
<b>Standard Flexible Cable Assemblies</b>						
<b>RG393/U Coax, 50 Ohm</b>						

\*Coax Performance at 1 GHz Notes: Cable assembly max frequency may be lower than connector or coax max frequency

Cable Assemblies

See Our Website For Current Pricing & Real-Time Stock Availability!

For our complete selection of cable assemblies, please visit our website

Part No. <a href="#">PE37497</a>				Cable Dia.	Attn. @ 1 GHz	Power @ 1 GHz	43
1 piece price shown. See web or call for volume pricing.				0.390" dia.	9 dB/100ft	1700 W	
12"	24"	36"	48"	60"	50CM	Custom Len.	
\$207.17	\$223.09	\$239.02	\$254.95	\$270.88	\$217.37	See Web	

**7/16 DIN MALE TO SMA MALE**



**Corrugated Cable Assemblies**

**SPP-250-LLPL Coax, 50 Ohm**

Part No. <a href="#">PE3C5886</a>				Cable Dia.	Attn. @ 1 GHz	Power @ 1 GHz	44
1 piece price shown. See web or call for volume pricing.				0.280" dia.	6 dB/100ft	650 W	
12"	24"	36"	48"	60"	50CM	Custom Len.	
\$75.40	\$80.98	\$86.56	\$92.14	\$97.72	\$78.97	See Web	

**7/16 DIN MALE TO SMA MALE RIGHT ANGLE**



**Low PIM Corrugated Cable Assemblies**

**SPP-250-LLPL Coax, 50 Ohm**

Part No. <a href="#">PE3C5891</a>				Cable Dia.	Attn. @ 1 GHz	Power @ 1 GHz	45
1 piece price shown. See web or call for volume pricing.				0.280" dia.	dB/100ft	W	
12"	24"	36"	48"	60"	50CM	Custom Len.	
\$76.85	\$82.43	\$88.01	\$93.59	\$99.17	\$80.43	See Web	

**7/16 DIN MALE TO SMA FEMALE**



**Low PIM Corrugated Cable Assemblies**

**SPP-250-LLPL Coax, 50 Ohm**

Part No. <a href="#">PE3C5880</a>				Cable Dia.	Attn. @ 1 GHz	Power @ 1 GHz	46
1 piece price shown. See web or call for volume pricing.				0.280" dia.	dB/100ft	W	
12"	24"	36"	48"	60"	50CM	Custom Len.	
\$76.13	\$81.71	\$87.29	\$92.87	\$98.45	\$79.70	See Web	

**7/16 DIN MALE RIGHT ANGLE TO 7/16 DIN MALE**



**Low PIM Corrugated Cable Assemblies**

**SPP-250-LLPL Coax, 50 Ohm**

Part No. <a href="#">PE3C4131</a>				Cable Dia.	Attn. @ 1 GHz	Power @ 1 GHz	47
1 piece price shown. See web or call for volume pricing.				0.280" dia.	dB/100ft	W	
12"	24"	36"	48"	60"	50CM	Custom Len.	
\$108.75	\$114.34	\$119.92	\$125.50	\$131.08	\$112.34	See Web	

**7/16 DIN MALE RIGHT ANGLE TO 7/16 DIN MALE RIGHT ANGLE**



**Low PIM Corrugated Cable Assemblies**

**SPP-250-LLPL Coax, 50 Ohm**

Part No. <a href="#">PE3C4144</a>				Cable Dia.	Attn. @ 1 GHz	Power @ 1 GHz	48
1 piece price shown. See web or call for volume pricing.				0.280" dia.	dB/100ft	W	
12"	24"	36"	48"	60"	50CM	Custom Len.	
\$120.44	\$125.92	\$131.60	\$137.18	\$142.76	\$124.02	See Web	

**7/16 DIN FEMALE TO N MALE**



**Low PIM Corrugated Cable Assemblies**

**SPP-250-LLPL Coax, 50 Ohm**

Part No. <a href="#">PE3C5856</a>				Cable Dia.	Attn. @ 1 GHz	Power @ 1 GHz	49
1 piece price shown. See web or call for volume pricing.				0.280" dia.	dB/100ft	W	
12"	24"	36"	48"	60"	50CM	Custom Len.	
\$86.23	\$91.81	\$97.39	\$102.96	\$108.54	\$89.80	See Web	

**7/16 DIN FEMALE TO QMA MALE**



**Low PIM Corrugated Cable Assemblies**

**SPP-250-LLPL Coax, 50 Ohm**

Part No. <a href="#">PE3C5857</a>				Cable Dia.	Attn. @ 1 GHz	Power @ 1 GHz	50
1 piece price shown. See web or call for volume pricing.				0.280" dia.	dB/100ft	W	
12"	24"	36"	48"	60"	50CM	Custom Len.	
\$82.62	\$88.20	\$93.78	\$99.36	\$104.94	\$86.20	See Web	

**7/16 DIN FEMALE TO SMA MALE**



**Low PIM Corrugated Cable Assemblies**

SPP-250-LLPL Coax, 50 Ohm							51
Part No. <a href="#">PE3C5858</a>							
1 piece price shown. See web or call for volume pricing.							
12"	24"	36"	48"	60"	50CM	Custom Len.	
\$75.40	\$80.98	\$86.56	\$92.14	\$97.72	\$78.97	See Web	

**10-32 MALE TO 10-32 MALE**



**Standard Flexible Cable Assemblies**

**RG174A/U Coax, 50 Ohm**

Part No. <a href="#">PE36520</a>				Cable Dia.	Attn. @ 1 GHz	Power @ 1 GHz	52
1 piece price shown. See web or call for volume pricing.				0.100" dia.	32 dB/100ft	16 W	
12"	24"	36"	48"	60"	72"	Custom Len.	
\$66.38	\$66.95	\$64.70	\$68.15	\$68.74	\$69.32	See Web	

**RG178B/U Coax, 50 Ohm**

Part No. <a href="#">PE36522</a>				Cable Dia.	Attn. @ 1 GHz	Power @ 1 GHz	53
1 piece price shown. See web or call for volume pricing.				0.072" dia.	44 dB/100ft	78 W	
12"	24"	36"	48"	60"	72"	Custom Len.	
\$89.22	\$90.16	\$96.69	\$92.10	\$98.89	\$94.01	See Web	

**RG316/U Coax, 50 Ohm**

Part No. <a href="#">PE36524</a>				Cable Dia.	Attn. @ 1 GHz	Power @ 1 GHz	54
1 piece price shown. See web or call for volume pricing.				0.098" dia.	38 dB/100ft	160 W	
12"	24"	36"	48"	60"	72"	Custom Len.	
\$67.83	\$70.71	\$73.60	\$81.46	\$84.64	\$87.83	See Web	

**10-32 MALE TO 10-32 MALE RIGHT ANGLE**



**Standard Flexible Cable Assemblies**

**RG174A/U Coax, 50 Ohm**

Part No. <a href="#">PE36526</a>				Cable Dia.	Attn. @ 1 GHz	Power @ 1 GHz	55
1 piece price shown. See web or call for volume pricing.				0.100" dia.	32 dB/100ft	16 W	
12"	24"	36"	48"	60"	72"	Custom Len.	
\$70.79	\$67.20	\$67.64	\$68.08	\$68.50	\$68.94	See Web	

**RG178B/U Coax, 50 Ohm**

Part No. <a href="#">PE36528</a>				Cable Dia.	Attn. @ 1 GHz	Power @ 1 GHz	56
1 piece price shown. See web or call for volume pricing.				0.072" dia.	44 dB/100ft	78 W	
12"	24"	36"	48"	60"	72"	Custom Len.	
\$86.88	\$87.83	\$88.78	\$89.75	\$90.70	\$91.66	See Web	

**RG316/U Coax, 50 Ohm**

Part No. <a href="#">PE36530</a>				Cable Dia.	Attn. @ 1 GHz	Power @ 1 GHz	57
1 piece price shown. See web or call for volume pricing.				0.098" dia.	38 dB/100ft	160 W	
12"	24"	36"	48"	60"	72"	Custom Len.	
\$68.13	\$71.02	\$73.90	\$76.79	\$79.69	\$82.57	See Web	

**10-32 MALE TO BNC MALE**



**Standard Flexible Cable Assemblies**

**RG174A/U Coax, 50 Ohm**

Part No. <a href="#">PE3C3275</a>				Cable Dia.	Attn. @ 1 GHz	Power @ 1 GHz	58
1 piece price shown. See web or call for volume pricing.				0.110" dia.	32 dB/100ft	17 W	
12"	24"	36"	48"	60"	72"	Custom Len.	
\$50.43	\$51.00	\$51.59	\$52.20	\$52.78	\$53.37	See Web	

**RG178B/U Coax, 50 Ohm**

Part No. <a href="#">PE36540</a>				Cable Dia.	Attn. @ 1 GHz	Power @ 1 GHz	59
1 piece price shown. See web or call for volume pricing.				0.072" dia.	44 dB/100ft	78 W	
12"	24"	36"	48"	60"	72"	Custom Len.	
\$82.29	\$83.35	\$84.41	\$80.51	\$81.48	\$82.42	See Web	

**RG316/U Coax, 50 Ohm**

Part No. <a href="#">PE3C3424</a>				Cable Dia.	Attn. @ 1 GHz	Power @ 1 GHz	60
1 piece price shown. See web or call for volume pricing.				0.102" dia.	38 dB/100ft	160 W	
12"	24"	36"	48"	60"	72"	Custom Len.	
\$48.48	\$51.61	\$54.31	\$57.20	\$61.23	\$64.41	See Web	

**10-32 MALE RIGHT ANGLE TO 10-32 MALE RIGHT ANGLE**



**Standard Flexible Cable Assemblies**

**RG174A/U Coax, 50 Ohm**

Part No. <a href="#">PE36532</a>				Cable Dia.	Attn. @ 1 GHz	Power @ 1 GHz	61
1 piece price shown. See web or call for volume pricing.				0.100" dia.	32 dB/100ft	16 W	
12"	24"	36"	48"	60"	72"	Custom Len.	
\$65.68	\$66.15	\$66.58	\$67.01	\$67.47	\$67.90	See Web	

**RG178B/U Coax, 50 Ohm**

Part No. <a href="#">PE36534</a>				Cable Dia.	Attn. @ 1 GHz	Power @ 1 GHz	62
1 piece price shown. See web or call for volume pricing.				0.072" dia.	44 dB/100ft	78 W	
12"	24"	36"	48"	60"	72"	Custom Len.	
\$94.95	\$95.91	\$96.87	\$97.83	\$98.79	\$106.05	See Web	

**RG316/U Coax, 50 Ohm**

Cable Assemblies

See Our Website For Current Pricing & Real-Time Stock Availability!

Continued on Next Page

For Custom Lengths, Metric Lengths or Special Configurations, Please call (949) 261-1920



Technical Support  
+1 (949) 261-1920



Same-Day Shipping,  
Even Custom Cable Assemblies

For our complete selection of cable assemblies, please visit our website

Part No.	PE36536	Cable Dia.	Attn. @ 1 GHz	Power @ 1 GHz
1 piece price shown. See web or call for volume pricing.				
12"	24"	36"	48"	60"
\$68.25	\$71.27	\$74.27	\$77.26	\$80.26
				\$88.27
				See Web

**10-32 FEMALE TO BNC MALE**



**Standard Flexible Cable Assemblies**

**RG178B/U Coax, 50 Ohm**

Part No.	PE3W03496	Cable Dia.	Attn. @ 1 GHz	Power @ 1 GHz
1 piece price shown. See web or call for volume pricing.				
12"	24"	36"	48"	60"
\$67.38	\$68.41	\$69.44	\$70.46	\$71.49
				\$68.03
				See Web

**BMA PLUG BULKHEAD TO BMA PLUG BULKHEAD**

SEE MOUNTING HOLE SECTION ON PAGE 369



**Formable Cable Assemblies**

**PE-SR402FLJ Coax, 50 Ohm**

Part No.	PE3C4899	Cable Dia.	Attn. @ 1 GHz	Power @ 1 GHz
1 piece price shown. See web or call for volume pricing.				
6"	12"	24"	36"	60"
\$70.53	\$74.19	\$81.53	\$88.86	\$103.52
				See Web

**PE-SR405FLJ Coax, 50 Ohm**

Part No.	PE3C4844	Cable Dia.	Attn. @ 1 GHz	Power @ 1 GHz
1 piece price shown. See web or call for volume pricing.				
6"	12"	24"	36"	60"
\$72.36	\$76.13	\$83.65	\$91.17	\$106.23
				See Web

**Flexible Cable Assemblies**

**RG316/U Coax, 50 Ohm**

Part No.	PE3C4936	Cable Dia.	Attn. @ 1 GHz	Power @ 1 GHz
1 piece price shown. See web or call for volume pricing.				
6"	12"	24"	36"	60"
\$109.22	\$110.63	\$113.42	\$116.22	\$121.83
				See Web

**RG400/U Coax, 50 Ohm**

Part No.	PE3C4950	Cable Dia.	Attn. @ 1 GHz	Power @ 1 GHz
1 piece price shown. See web or call for volume pricing.				
6"	12"	24"	36"	60"
\$84.60	\$87.98	\$94.74	\$101.50	\$115.04
				See Web

**LMR-100A-PVC Coax, 50 Ohm**

Part No.	PE3C4921	Cable Dia.	Attn. @ 1 GHz	Power @ 1 GHz
1 piece price shown. See web or call for volume pricing.				
6"	12"	24"	36"	60"
\$103.41	\$103.79	\$104.52	\$105.26	\$106.74
				See Web

**Semi-Rigid Cable Assemblies**

**RG405/U Coax, 50 Ohm**

Part No.	PE3C4872	Cable Dia.	Attn. @ 1 GHz	Power @ 1 GHz
1 piece price shown. See web or call for volume pricing.				
6"	12"	24"	36"	60"
\$71.94	\$75.27	\$81.93	\$86.61	\$101.94
				See Web

**BMA PLUG BULKHEAD TO BMA JACK**

SEE MOUNTING HOLE SECTION ON PAGE 369



**Formable Cable Assemblies**

**PE-SR402FLJ Coax, 50 Ohm**

Part No.	PE3C4904	Cable Dia.	Attn. @ 1 GHz	Power @ 1 GHz
1 piece price shown. See web or call for volume pricing.				
6"	12"	24"	36"	60"
\$125.65	\$129.31	\$136.65	\$143.97	\$158.63
				See Web

**PE-SR405FLJ Coax, 50 Ohm**

Part No.	PE3C4852	Cable Dia.	Attn. @ 1 GHz	Power @ 1 GHz
1 piece price shown. See web or call for volume pricing.				
6"	12"	24"	36"	60"
\$115.66	\$119.43	\$126.96	\$134.48	\$149.53
				See Web

**Flexible Cable Assemblies**

**RG316/U Coax, 50 Ohm**

Part No.	PE3C4940	Cable Dia.	Attn. @ 1 GHz	Power @ 1 GHz
1 piece price shown. See web or call for volume pricing.				
6"	12"	24"	36"	60"
\$139.15	\$140.57	\$143.36	\$146.16	\$151.77
				See Web

**RG400/U Coax, 50 Ohm**

Part No.	PE3C4953	Cable Dia.	Attn. @ 1 GHz	Power @ 1 GHz
1 piece price shown. See web or call for volume pricing.				
6"	12"	24"	36"	60"
\$153.04	\$156.43	\$163.20	\$169.96	\$183.49
				See Web

**LMR-100A-PVC Coax, 50 Ohm**

Part No.	PE3C4925	Cable Dia.	Attn. @ 1 GHz	Power @ 1 GHz
1 piece price shown. See web or call for volume pricing.				
6"	12"	24"	36"	60"
\$133.35	\$133.72	\$134.46	\$135.19	\$136.67
				See Web

**Semi-Rigid Cable Assemblies**

**RG405/U Coax, 50 Ohm**

Part No.	PE3C4879	Cable Dia.	Attn. @ 1 GHz	Power @ 1 GHz
1 piece price shown. See web or call for volume pricing.				
6"	12"	24"	36"	60"
\$115.25	\$118.57	\$125.23	\$131.90	\$145.24
				See Web

**BMA PLUG BULKHEAD TO BMA JACK BULKHEAD**

SEE MOUNTING HOLE SECTION ON PAGE 369



**Formable Cable Assemblies**

**PE-SR405FLJ Coax, 50 Ohm**

Part No.	PE3C4851	Cable Dia.	Attn. @ 1 GHz	Power @ 1 GHz
1 piece price shown. See web or call for volume pricing.				
6"	12"	24"	36"	60"
\$91.35	\$95.11	\$102.64	\$110.17	\$125.21
				See Web

**Semi-Rigid Cable Assemblies**

**RG405/U Coax, 50 Ohm**

Part No.	PE3C4878	Cable Dia.	Attn. @ 1 GHz	Power @ 1 GHz
1 piece price shown. See web or call for volume pricing.				
6"	12"	24"	36"	60"
\$90.92	\$94.26	\$100.92	\$107.59	\$120.93
				See Web

**BMA PLUG BULKHEAD TO BMA JACK 2 HOLE FLANGE**

SEE MOUNTING HOLE SECTION ON PAGE 369



**Formable Cable Assemblies**

**PE-SR402FLJ Coax, 50 Ohm**

Part No.	PE3C4903	Cable Dia.	Attn. @ 1 GHz	Power @ 1 GHz
1 piece price shown. See web or call for volume pricing.				
6"	12"	24"	36"	60"
\$84.53	\$88.21	\$95.54	\$102.87	\$117.52
				See Web

**PE-SR405FLJ Coax, 50 Ohm**

Part No.	PE3C4850	Cable Dia.	Attn. @ 1 GHz	Power @ 1 GHz
1 piece price shown. See web or call for volume pricing.				
6"	12"	24"	36"	60"
\$97.09	\$100.87	\$108.39	\$115.91	\$130.97
				See Web

**Flexible Cable Assemblies**

**RG316/U Coax, 50 Ohm**

Part No.	PE3C4939	Cable Dia.	Attn. @ 1 GHz	Power @ 1 GHz
1 piece price shown. See web or call for volume pricing.				
6"	12"	24"	36"	60"
\$104.81	\$106.23	\$109.01	\$111.82	\$117.43
				See Web

**LMR-100A-PVC Coax, 50 Ohm**

Part No.	PE3C4924	Cable Dia.	Attn. @ 1 GHz	Power @ 1 GHz
1 piece price shown. See web or call for volume pricing.				
6"	12"	24"	36"	60"
\$99.01	\$99.38	\$100.12	\$100.86	\$102.32
				See Web

**Semi-Rigid Cable Assemblies**

**RG405/U Coax, 50 Ohm**

Part No.	PE3C4877	Cable Dia.	Attn. @ 1 GHz	Power @ 1 GHz
1 piece price shown. See web or call for volume pricing.				
6"	12"	24"	36"	60"
\$96.68	\$100.00	\$106.66	\$113.33	\$126.67
				See Web

**BMA PLUG BULKHEAD TO BMA JACK RIGHT ANGLE 2 HOLE FLANGE**

SEE MOUNTING HOLE SECTION ON PAGE 369



**Formable Cable Assemblies**

**PE-SR402FLJ Coax, 50 Ohm**

Part No.	PE3C4905	Cable Dia.	Attn. @ 1 GHz	Power @ 1 GHz
1 piece price shown. See web or call for volume pricing.				
6"	12"	24"	36"	60"
\$113.58	\$117.25	\$124.59	\$131.91	\$146.57
				See Web

**PE-SR405FLJ Coax, 50 Ohm**

Part No.	PE3C4853	Cable Dia.	Attn. @ 1 GHz	Power @ 1 GHz
1 piece price shown. See web or call for volume pricing.				
6"	12"	24"	36"	60"
\$108.98	\$112.75	\$120.27	\$127.80	\$142.85
				See Web

**Flexible Cable Assemblies**

**RG400/U Coax, 50 Ohm**

Part No.	PE3C4954	Cable Dia.	Attn. @ 1 GHz	Power @ 1 GHz
1 piece price shown. See web or call for volume pricing.				
6"	12"	24"	36"	60"
\$106.69	\$110.09	\$116.85	\$123.61	\$137.15
				See Web

**Semi-Rigid Cable Assemblies**

**RG405/U Coax, 50 Ohm**

Part No.	PE3C4880	Cable Dia.	Attn. @ 1 GHz	Power @ 1 GHz
1 piece price shown. See web or call for volume pricing.				
6"	12"	24"	36"	60"
\$108.57	\$111.90	\$118.55	\$125.22	\$138.56
				See Web

Cable Assemblies See Our Website For Current Pricing & Real-Time Stock Availability!

\*Coax Performance at 1 GHz Notes: Cable assembly max frequency may be lower than connector or coax max frequency

For our complete selection of cable assemblies, please visit our website

Cable Assemblies

See Our Website For Current Pricing & Real-Time Stock Availability!

<b>BMA PLUG BULKHEAD TO BNC MALE</b>						
SEE MOUNTING HOLE SECTION ON PAGE 369						
<b>Formable Cable Assemblies</b>						
<b>PE-SR402FLJ Coax, 50 Ohm</b>						
Part No. <b>PE3C4918</b>		Cable Dia.	Attn. @ 1 GHz	Power @ 1 GHz		
1 piece price shown. See web or call for volume pricing.		0.161" dia.	12 dB/100ft	303 W		
6"	12"	24"	36"	60"	Custom Len.	88
\$69.82	\$73.50	\$80.82	\$88.15	\$102.81	See Web	
<b>Flexible Cable Assemblies</b>						
<b>RG316/U Coax, 50 Ohm</b>						
Part No. <b>PE3C4949</b>		Cable Dia.	Attn. @ 1 GHz	Power @ 1 GHz		
1 piece price shown. See web or call for volume pricing.		0.098" dia.	58 dB/100ft	160 W		
6"	12"	24"	36"	60"	Custom Len.	89
\$69.23	\$70.64	\$73.43	\$76.23	\$81.84	See Web	
<b>RG400/U Coax, 50 Ohm</b>						
Part No. <b>PE3C4963</b>		Cable Dia.	Attn. @ 1 GHz	Power @ 1 GHz		
1 piece price shown. See web or call for volume pricing.		0.195" dia.	15 dB/100ft	600 W		
6"	12"	24"	36"	60"	Custom Len.	90
\$58.30	\$61.69	\$68.44	\$75.20	\$88.74	See Web	
<b>LMR-100A-PVC Coax, 50 Ohm</b>						
Part No. <b>PE3C4935</b>		Cable Dia.	Attn. @ 1 GHz	Power @ 1 GHz		
1 piece price shown. See web or call for volume pricing.		0.110" dia.	24 dB/100ft	W		
6"	12"	24"	36"	60"	Custom Len.	91
\$63.41	\$63.79	\$64.53	\$65.27	\$66.73	See Web	

<b>BMA PLUG BULKHEAD TO N MALE</b>						
SEE MOUNTING HOLE SECTION ON PAGE 369						
<b>Formable Cable Assemblies</b>						
<b>PE-SR402FLJ Coax, 50 Ohm</b>						
Part No. <b>PE3C4912</b>		Cable Dia.	Attn. @ 1 GHz	Power @ 1 GHz		
1 piece price shown. See web or call for volume pricing.		0.161" dia.	12 dB/100ft	303 W		
6"	12"	24"	36"	60"	Custom Len.	92
\$62.41	\$66.08	\$73.41	\$80.74	\$95.40	See Web	
<b>PE-SR405FLJ Coax, 50 Ohm</b>						
Part No. <b>PE3C4860</b>		Cable Dia.	Attn. @ 1 GHz	Power @ 1 GHz		
1 piece price shown. See web or call for volume pricing.		0.105" dia.	20 dB/100ft	122 W		
6"	12"	24"	36"	60"	Custom Len.	93
\$63.37	\$67.14	\$74.66	\$82.18	\$97.24	See Web	
<b>Flexible Cable Assemblies</b>						
<b>RG316/U Coax, 50 Ohm</b>						
Part No. <b>PE3C4945</b>		Cable Dia.	Attn. @ 1 GHz	Power @ 1 GHz		
1 piece price shown. See web or call for volume pricing.		0.098" dia.	58 dB/100ft	160 W		
6"	12"	24"	36"	60"	Custom Len.	94
\$89.82	\$78.56	\$79.97	\$82.77	\$85.56	See Web	
<b>RG400/U Coax, 50 Ohm</b>						
Part No. <b>PE3C4959</b>		Cable Dia.	Attn. @ 1 GHz	Power @ 1 GHz		
1 piece price shown. See web or call for volume pricing.		0.195" dia.	15 dB/100ft	600 W		
6"	12"	24"	36"	60"	Custom Len.	95
\$68.20	\$71.59	\$78.34	\$85.11	\$98.64	See Web	
<b>LMR-100A-PVC Coax, 50 Ohm</b>						
Part No. <b>PE3C4931</b>		Cable Dia.	Attn. @ 1 GHz	Power @ 1 GHz		
1 piece price shown. See web or call for volume pricing.		0.110" dia.	24 dB/100ft	W		
6"	12"	24"	36"	60"	Custom Len.	96
\$72.75	\$73.12	\$73.86	\$74.60	\$76.08	See Web	
<b>Semi-Rigid Cable Assemblies</b>						
<b>RG405/U Coax, 50 Ohm</b>						
Part No. <b>PE3C4887</b>		Cable Dia.	Attn. @ 1 GHz	Power @ 1 GHz		
1 piece price shown. See web or call for volume pricing.		" dia.	22 dB/100ft	130 W		
6"	12"	24"	36"	60"	Custom Len.	97
\$62.95	\$66.29	\$72.94	\$79.61	\$92.95	See Web	

<b>BMA PLUG BULKHEAD TO SMA MALE</b>						
SEE MOUNTING HOLE SECTION ON PAGE 369						
<b>Formable Cable Assemblies</b>						
<b>PE-SR402FLJ Coax, 50 Ohm</b>						
Part No. <b>PE3C4906</b>		Cable Dia.	Attn. @ 1 GHz	Power @ 1 GHz		
1 piece price shown. See web or call for volume pricing.		0.161" dia.	12 dB/100ft	303 W		
6"	12"	24"	36"	60"	Custom Len.	98
\$54.72	\$58.39	\$65.72	\$73.05	\$87.71	See Web	
<b>PE-SR405FLJ Coax, 50 Ohm</b>						
Part No. <b>PE3C4854</b>		Cable Dia.	Attn. @ 1 GHz	Power @ 1 GHz		
1 piece price shown. See web or call for volume pricing.		0.105" dia.	20 dB/100ft	122 W		
6"	12"	24"	36"	60"	Custom Len.	99
\$56.44	\$60.21	\$67.73	\$75.25	\$90.31	See Web	

<b>Flexible Cable Assemblies</b>						
<b>RG316/U Coax, 50 Ohm</b>						
Part No. <b>PE3C4942</b>		Cable Dia.	Attn. @ 1 GHz	Power @ 1 GHz		
1 piece price shown. See web or call for volume pricing.		0.098" dia.	58 dB/100ft	160 W		
6"	12"	24"	36"	60"	Custom Len.	1
\$72.53	\$73.94	\$76.73	\$79.54	\$85.15	See Web	
<b>RG400/U Coax, 50 Ohm</b>						
Part No. <b>PE3C4955</b>		Cable Dia.	Attn. @ 1 GHz	Power @ 1 GHz		
1 piece price shown. See web or call for volume pricing.		0.195" dia.	15 dB/100ft	600 W		
6"	12"	24"	36"	60"	Custom Len.	2
\$62.80	\$66.18	\$72.94	\$79.71	\$93.24	See Web	
<b>LMR-100A-PVC Coax, 50 Ohm</b>						
Part No. <b>PE3C4927</b>		Cable Dia.	Attn. @ 1 GHz	Power @ 1 GHz		
1 piece price shown. See web or call for volume pricing.		0.110" dia.	24 dB/100ft	W		
6"	12"	24"	36"	60"	Custom Len.	3
\$66.71	\$67.10	\$67.84	\$68.56	\$70.04	See Web	

<b>Semi-Rigid Cable Assemblies</b>						
<b>RG405/U Coax, 50 Ohm</b>						
Part No. <b>PE3C4881</b>		Cable Dia.	Attn. @ 1 GHz	Power @ 1 GHz		
1 piece price shown. See web or call for volume pricing.		" dia.	22 dB/100ft	130 W		
6"	12"	24"	36"	60"	Custom Len.	4
\$56.02	\$59.36	\$66.02	\$72.68	\$86.02	See Web	

<b>Formable Cable Assemblies</b>						
<b>PE-SR402FLJ Coax, 50 Ohm</b>						
Part No. <b>PE3C4909</b>		Cable Dia.	Attn. @ 1 GHz	Power @ 1 GHz		
1 piece price shown. See web or call for volume pricing.		0.161" dia.	12 dB/100ft	303 W		
6"	12"	24"	36"	60"	Custom Len.	5
\$57.37	\$61.04	\$68.38	\$75.70	\$90.36	See Web	
<b>PE-SR405FLJ Coax, 50 Ohm</b>						
Part No. <b>PE3C4857</b>		Cable Dia.	Attn. @ 1 GHz	Power @ 1 GHz		
1 piece price shown. See web or call for volume pricing.		0.105" dia.	20 dB/100ft	122 W		
6"	12"	24"	36"	60"	Custom Len.	6
\$58.34	\$62.10	\$69.63	\$77.16	\$92.20	See Web	

<b>Flexible Cable Assemblies</b>						
<b>RG316/U Coax, 50 Ohm</b>						
Part No. <b>PE3C4386</b>		Cable Dia.	Attn. @ 1 GHz	Power @ 1 GHz		
1 piece price shown. See web or call for volume pricing.		0.098" dia.	58 dB/100ft	160 W		
6"	12"	24"	36"	60"	Custom Len.	7
\$87.28	\$88.69	\$91.47	\$94.28	\$99.89	See Web	
<b>RG400/U Coax, 50 Ohm</b>						
Part No. <b>PE3C4957</b>		Cable Dia.	Attn. @ 1 GHz	Power @ 1 GHz		
1 piece price shown. See web or call for volume pricing.		0.195" dia.	15 dB/100ft	600 W		
6"	12"	24"	36"	60"	Custom Len.	8
\$72.71	\$76.10	\$82.85	\$89.61	\$103.15	See Web	
<b>LMR-100A-PVC Coax, 50 Ohm</b>						
Part No. <b>PE3C4929</b>		Cable Dia.	Attn. @ 1 GHz	Power @ 1 GHz		
1 piece price shown. See web or call for volume pricing.		0.110" dia.	24 dB/100ft	W		
6"	12"	24"	36"	60"	Custom Len.	9
\$76.73	\$78.27	\$79.01	\$78.55	\$80.00	See Web	

<b>Semi-Rigid Cable Assemblies</b>						
<b>RG405/U Coax, 50 Ohm</b>						
Part No. <b>PE3C4884</b>		Cable Dia.	Attn. @ 1 GHz	Power @ 1 GHz		
1 piece price shown. See web or call for volume pricing.		" dia.	22 dB/100ft	130 W		
6"	12"	24"	36"	60"	Custom Len.	10
\$57.91	\$61.25	\$67.91	\$74.58	\$87.92	See Web	

<b>BMA PLUG BULKHEAD TO SMP FEMALE</b>						
SEE MOUNTING HOLE SECTION ON PAGE 369						
<b>Formable Cable Assemblies</b>						
<b>PE-SR405FLJ Coax, 50 Ohm</b>						
Part No. <b>PE3C4866</b>		Cable Dia.	Attn. @ 1 GHz	Power @ 1 GHz		
1 piece price shown. See web or call for volume pricing.		0.105" dia.	20 dB/100ft	122 W		
6"	12"	24"	36"	60"	Custom Len.	11
\$65.03	\$68.79	\$76.32	\$83.85	\$98.89	See Web	
<b>Semi-Rigid Cable Assemblies</b>						
<b>RG405/U Coax, 50 Ohm</b>						
Part No. <b>PE3C4893</b>		Cable Dia.	Attn. @ 1 GHz	Power @ 1 GHz		
1 piece price shown. See web or call for volume pricing.		" dia.	22 dB/100ft	130 W		
6"	12"	24"	36"	60"	Custom Len.	12
\$64.61	\$67.94	\$74.60	\$81.27	\$94.60	See Web	

For Custom Lengths, Metric Lengths or Special Configurations, Please call (949) 261-1920



Technical Support  
+1 (949) 261-1920



Same-Day Shipping,  
Even Custom Cable Assemblies

For our complete selection of cable assemblies, please visit our website

Cable Assemblies

See Our Website For Current Pricing & Real-Time Stock Availability!

<b>BMA PLUG BULKHEAD TO SMP FEMALE RIGHT ANGLE</b>				
SEE MOUNTING HOLE SECTION ON PAGE 369				
Formable Cable Assemblies				
PE-SR405FLJ Coax, 50 Ohm				
Part No. <a href="#">PE3C4869</a>	Cable Dia.	Attn. @ 1 GHz	Power @ 1 GHz	
1 piece price shown. See web or call for volume pricing.				
6"	12"	24"	36"	60"
\$76.78	\$80.55	\$88.08	\$95.60	\$110.65
				Custom Len.
				See Web
Semi-Rigid Cable Assemblies				
RG405/U Coax, 50 Ohm				
Part No. <a href="#">PE3C4896</a>	Cable Dia.	Attn. @ 1 GHz	Power @ 1 GHz	
1 piece price shown. See web or call for volume pricing.				
6"	12"	24"	36"	60"
\$76.37	\$79.70	\$86.35	\$93.02	\$106.36
				Custom Len.
				See Web
Formable Cable Assemblies				
PE-SR402FLJ Coax, 50 Ohm				
Part No. <a href="#">PE3C4915</a>	Cable Dia.	Attn. @ 1 GHz	Power @ 1 GHz	
1 piece price shown. See web or call for volume pricing.				
6"	12"	24"	36"	60"
\$59.24	\$62.92	\$70.25	\$77.57	\$92.23
				Custom Len.
				See Web
Formable Cable Assemblies				
PE-SR405FLJ Coax, 50 Ohm				
Part No. <a href="#">PE3C4863</a>	Cable Dia.	Attn. @ 1 GHz	Power @ 1 GHz	
1 piece price shown. See web or call for volume pricing.				
6"	12"	24"	36"	60"
\$60.21	\$63.98	\$71.50	\$79.03	\$94.07
				Custom Len.
				See Web
Flexible Cable Assemblies				
RG316/U Coax, 50 Ohm				
Part No. <a href="#">PE3C4947</a>	Cable Dia.	Attn. @ 1 GHz	Power @ 1 GHz	
1 piece price shown. See web or call for volume pricing.				
6"	12"	24"	36"	60"
\$86.76	\$88.17	\$90.95	\$93.76	\$99.37
				Custom Len.
				See Web
Formable Cable Assemblies				
RG400/U Coax, 50 Ohm				
Part No. <a href="#">PE3C4961</a>	Cable Dia.	Attn. @ 1 GHz	Power @ 1 GHz	
1 piece price shown. See web or call for volume pricing.				
6"	12"	24"	36"	60"
\$62.76	\$66.14	\$72.90	\$79.67	\$93.20
				Custom Len.
				See Web
Formable Cable Assemblies				
LMR-100A-PVC Coax, 50 Ohm				
Part No. <a href="#">PE3C4933</a>	Cable Dia.	Attn. @ 1 GHz	Power @ 1 GHz	
1 piece price shown. See web or call for volume pricing.				
6"	12"	24"	36"	60"
\$80.94	\$81.32	\$82.06	\$82.80	\$84.26
				Custom Len.
				See Web
Semi-Rigid Cable Assemblies				
RG405/U Coax, 50 Ohm				
Part No. <a href="#">PE3C4890</a>	Cable Dia.	Attn. @ 1 GHz	Power @ 1 GHz	
1 piece price shown. See web or call for volume pricing.				
6"	12"	24"	36"	60"
\$59.78	\$63.12	\$69.78	\$76.45	\$89.79
				Custom Len.
				See Web
Formable Cable Assemblies				
PE-SR402FLJ Coax, 50 Ohm				
Part No. <a href="#">PE3C4901</a>	Cable Dia.	Attn. @ 1 GHz	Power @ 1 GHz	
1 piece price shown. See web or call for volume pricing.				
6"	12"	24"	36"	60"
\$180.77	\$184.43	\$191.76	\$199.09	\$213.75
				Custom Len.
				See Web
Formable Cable Assemblies				
PE-SR405FLJ Coax, 50 Ohm				
Part No. <a href="#">PE3C4848</a>	Cable Dia.	Attn. @ 1 GHz	Power @ 1 GHz	
1 piece price shown. See web or call for volume pricing.				
6"	12"	24"	36"	60"
\$158.97	\$162.74	\$170.26	\$177.78	\$192.84
				Custom Len.
				See Web
Flexible Cable Assemblies				
RG316/U Coax, 50 Ohm				
Part No. <a href="#">PE3C4938</a>	Cable Dia.	Attn. @ 1 GHz	Power @ 1 GHz	
1 piece price shown. See web or call for volume pricing.				
6"	12"	24"	36"	60"
\$169.09	\$170.50	\$173.29	\$176.10	\$181.70
				Custom Len.
				See Web
Formable Cable Assemblies				
RG400/U Coax, 50 Ohm				
Part No. <a href="#">PE3C4951</a>	Cable Dia.	Attn. @ 1 GHz	Power @ 1 GHz	
1 piece price shown. See web or call for volume pricing.				
6"	12"	24"	36"	60"
\$221.50	\$224.89	\$231.65	\$238.41	\$251.95
				Custom Len.
				See Web

<b>LMR-100A-PVC Coax, 50 Ohm</b>				
Part No. <a href="#">PE3C4923</a>	Cable Dia.	Attn. @ 1 GHz	Power @ 1 GHz	
1 piece price shown. See web or call for volume pricing.				
6"	12"	24"	36"	60"
\$163.28	\$163.65	\$164.39	\$165.13	\$166.60
				Custom Len.
				See Web
Semi-Rigid Cable Assemblies				
RG405/U Coax, 50 Ohm				
Part No. <a href="#">PE3C4875</a>	Cable Dia.	Attn. @ 1 GHz	Power @ 1 GHz	
1 piece price shown. See web or call for volume pricing.				
6"	12"	24"	36"	60"
\$158.55	\$161.88	\$168.54	\$175.21	\$188.55
				Custom Len.
				See Web
Formable Cable Assemblies				
PE-SR402FLJ Coax, 50 Ohm				
Part No. <a href="#">PE3C4920</a>	Cable Dia.	Attn. @ 1 GHz	Power @ 1 GHz	
1 piece price shown. See web or call for volume pricing.				
6"	12"	24"	36"	60"
\$124.94	\$128.61	\$135.94	\$143.27	\$157.93
				Custom Len.
				See Web
Flexible Cable Assemblies				
RG316/U Coax, 50 Ohm				
Part No. <a href="#">PE3C4948</a>	Cable Dia.	Attn. @ 1 GHz	Power @ 1 GHz	
1 piece price shown. See web or call for volume pricing.				
6"	12"	24"	36"	60"
\$99.16	\$100.58	\$103.36	\$106.17	\$111.78
				Custom Len.
				See Web
Formable Cable Assemblies				
RG400/U Coax, 50 Ohm				
Part No. <a href="#">PE3C4964</a>	Cable Dia.	Attn. @ 1 GHz	Power @ 1 GHz	
1 piece price shown. See web or call for volume pricing.				
6"	12"	24"	36"	60"
\$126.75	\$130.13	\$136.90	\$143.66	\$157.19
				Custom Len.
				See Web
Formable Cable Assemblies				
LMR-100A-PVC Coax, 50 Ohm				
Part No. <a href="#">PE3C4934</a>	Cable Dia.	Attn. @ 1 GHz	Power @ 1 GHz	
1 piece price shown. See web or call for volume pricing.				
6"	12"	24"	36"	60"
\$93.35	\$93.73	\$94.47	\$95.20	\$96.68
				Custom Len.
				See Web
Formable Cable Assemblies				
PE-SR402FLJ Coax, 50 Ohm				
Part No. <a href="#">PE3C4914</a>	Cable Dia.	Attn. @ 1 GHz	Power @ 1 GHz	
1 piece price shown. See web or call for volume pricing.				
6"	12"	24"	36"	60"
\$117.52	\$121.20	\$128.52	\$135.86	\$150.51
				Custom Len.
				See Web
Formable Cable Assemblies				
PE-SR405FLJ Coax, 50 Ohm				
Part No. <a href="#">PE3C4862</a>	Cable Dia.	Attn. @ 1 GHz	Power @ 1 GHz	
1 piece price shown. See web or call for volume pricing.				
6"	12"	24"	36"	60"
\$106.67	\$110.45	\$117.97	\$125.49	\$140.55
				Custom Len.
				See Web
Flexible Cable Assemblies				
RG316/U Coax, 50 Ohm				
Part No. <a href="#">PE3C4944</a>	Cable Dia.	Attn. @ 1 GHz	Power @ 1 GHz	
1 piece price shown. See web or call for volume pricing.				
6"	12"	24"	36"	60"
\$108.49	\$109.91	\$112.70	\$115.51	\$121.11
				Custom Len.
				See Web
Formable Cable Assemblies				
RG400/U Coax, 50 Ohm				
Part No. <a href="#">PE3C4960</a>	Cable Dia.	Attn. @ 1 GHz	Power @ 1 GHz	
1 piece price shown. See web or call for volume pricing.				
6"	12"	24"	36"	60"
\$136.66	\$140.05	\$146.80	\$153.56	\$167.10
				Custom Len.
				See Web
Formable Cable Assemblies				
LMR-100A-PVC Coax, 50 Ohm				
Part No. <a href="#">PE3C4930</a>	Cable Dia.	Attn. @ 1 GHz	Power @ 1 GHz	
1 piece price shown. See web or call for volume pricing.				
6"	12"	24"	36"	60"
\$102.68	\$9.95	\$103.80	\$104.53	\$106.01
				Custom Len.
				See Web
Semi-Rigid Cable Assemblies				
RG405/U Coax, 50 Ohm				
Part No. <a href="#">PE3C4889</a>	Cable Dia.	Attn. @ 1 GHz	Power @ 1 GHz	
1 piece price shown. See web or call for volume pricing.				
6"	12"	24"	36"	60"
\$106.26	\$109.59	\$116.24	\$122.91	\$136.25
				Custom Len.
				See Web
Formable Cable Assemblies				
BMA JACK TO SMA MALE				

\*Coax Performance at 1 GHz Notes: Cable assembly max frequency may be lower than connector or coax max frequency

For our complete selection of cable assemblies, please visit our website

PE-SR402FLJ Coax, 50 Ohm				
Part No. <b>PE3C4908</b>				
1 piece price shown. See web or call for volume pricing.				
Cable Dia.	Attn. @ 1 GHz	Power @ 1 GHz		
0.161" dia.	12 dB/100ft	303 W		
6"	12"	24"	36"	60"
\$109.84	\$113.51	\$120.84	\$128.17	\$142.83
- See Web				
PE-SR405FLJ Coax, 50 Ohm				
Part No. <b>PE3C4856</b>				
1 piece price shown. See web or call for volume pricing.				
Cable Dia.	Attn. @ 1 GHz	Power @ 1 GHz		
0.105" dia.	20 dB/100ft	122 W		
6"	12"	24"	36"	60"
\$99.74	\$103.52	\$111.04	\$126.09	\$133.62
- See Web				
Flexible Cable Assemblies				
RG316/U Coax, 50 Ohm				
Part No. <b>PE3C4941</b>				
1 piece price shown. See web or call for volume pricing.				
Cable Dia.	Attn. @ 1 GHz	Power @ 1 GHz		
0.098" dia.	58 dB/100ft	160 W		
6"	12"	24"	36"	60"
\$102.47	\$103.87	\$106.66	\$109.47	\$115.08
- See Web				
RG400/U Coax, 50 Ohm				
Part No. <b>PE3C4956</b>				
1 piece price shown. See web or call for volume pricing.				
Cable Dia.	Attn. @ 1 GHz	Power @ 1 GHz		
0.195" dia.	15 dB/100ft	600 W		
6"	12"	24"	36"	60"
\$131.26	\$134.64	\$141.40	\$148.16	\$161.70
- See Web				
LMR-100A-PVC Coax, 50 Ohm				
Part No. <b>PE3C4926</b>				
1 piece price shown. See web or call for volume pricing.				
Cable Dia.	Attn. @ 1 GHz	Power @ 1 GHz		
0.110" dia.	24 dB/100ft	W		
6"	12"	24"	36"	60"
\$96.65	\$97.03	\$97.77	\$98.51	\$99.97
- See Web				
Semi-Rigid Cable Assemblies				
RG405/U Coax, 50 Ohm				
Part No. <b>PE3C4883</b>				
1 piece price shown. See web or call for volume pricing.				
Cable Dia.	Attn. @ 1 GHz	Power @ 1 GHz		
" dia.	22 dB/100ft	130 W		
6"	12"	24"	36"	60"
\$99.33	\$102.66	\$109.32	\$115.98	\$129.32
- See Web				
BMA JACK TO SMA MALE RIGHT ANGLE				
Formable Cable Assemblies				
PE-SR402FLJ Coax, 50 Ohm				
Part No. <b>PE3C4911</b>				
1 piece price shown. See web or call for volume pricing.				
Cable Dia.	Attn. @ 1 GHz	Power @ 1 GHz		
0.161" dia.	12 dB/100ft	303 W		
6"	12"	24"	36"	60"
\$112.49	\$116.16	\$123.50	\$130.82	\$145.48
- See Web				
PE-SR405FLJ Coax, 50 Ohm				
Part No. <b>PE3C4859</b>				
1 piece price shown. See web or call for volume pricing.				
Cable Dia.	Attn. @ 1 GHz	Power @ 1 GHz		
0.105" dia.	20 dB/100ft	122 W		
6"	12"	24"	36"	60"
\$101.65	\$105.41	\$112.94	\$120.46	\$135.51
- See Web				
Flexible Cable Assemblies				
RG316/U Coax, 50 Ohm				
Part No. <b>PE3C4943</b>				
1 piece price shown. See web or call for volume pricing.				
Cable Dia.	Attn. @ 1 GHz	Power @ 1 GHz		
0.098" dia.	58 dB/100ft	160 W		
6"	12"	24"	36"	60"
\$117.21	\$118.62	\$121.41	\$124.21	\$129.82
- See Web				
RG400/U Coax, 50 Ohm				
Part No. <b>PE3C4958</b>				
1 piece price shown. See web or call for volume pricing.				
Cable Dia.	Attn. @ 1 GHz	Power @ 1 GHz		
0.195" dia.	15 dB/100ft	600 W		
6"	12"	24"	36"	60"
\$141.16	\$144.55	\$151.30	\$158.07	\$171.60
- See Web				
LMR-100A-PVC Coax, 50 Ohm				
Part No. <b>PE3C4928</b>				
1 piece price shown. See web or call for volume pricing.				
Cable Dia.	Attn. @ 1 GHz	Power @ 1 GHz		
0.110" dia.	24 dB/100ft	W		
6"	12"	24"	36"	60"
\$106.62	\$107.01	\$107.73	\$108.47	\$109.95
- See Web				
Semi-Rigid Cable Assemblies				
RG405/U Coax, 50 Ohm				
Part No. <b>PE3C4886</b>				
1 piece price shown. See web or call for volume pricing.				
Cable Dia.	Attn. @ 1 GHz	Power @ 1 GHz		
" dia.	22 dB/100ft	130 W		
6"	12"	24"	36"	60"
\$101.22	\$104.55	\$111.21	\$117.88	\$131.23
- See Web				
BMA JACK TO SMP FEMALE				
Formable Cable Assemblies				
PE-SR405FLJ Coax, 50 Ohm				
Part No. <b>PE3C4868</b>				
1 piece price shown. See web or call for volume pricing.				
Cable Dia.	Attn. @ 1 GHz	Power @ 1 GHz		
0.105" dia.	20 dB/100ft	122 W		
6"	12"	24"	36"	60"
\$108.34	\$112.10	\$119.63	\$127.15	\$142.20
- See Web				
Semi-Rigid Cable Assemblies				

RG405/U Coax, 50 Ohm				
Part No. <b>PE3C4895</b>				
1 piece price shown. See web or call for volume pricing.				
Cable Dia.	Attn. @ 1 GHz	Power @ 1 GHz		
" dia.	22 dB/100ft	130 W		
6"	12"	24"	36"	60"
\$107.91	\$111.25	\$117.91	\$124.58	\$137.91
- See Web				
BMA JACK TO SMP FEMALE RIGHT ANGLE				
Formable Cable Assemblies				
PE-SR405FLJ Coax, 50 Ohm				
Part No. <b>PE3C4871</b>				
1 piece price shown. See web or call for volume pricing.				
Cable Dia.	Attn. @ 1 GHz	Power @ 1 GHz		
0.105" dia.	20 dB/100ft	122 W		
6"	12"	24"	36"	60"
\$120.09	\$123.86	\$131.38	\$138.90	\$153.96
- See Web				
Semi-Rigid Cable Assemblies				
RG405/U Coax, 50 Ohm				
Part No. <b>PE3C4898</b>				
1 piece price shown. See web or call for volume pricing.				
Cable Dia.	Attn. @ 1 GHz	Power @ 1 GHz		
" dia.	22 dB/100ft	130 W		
6"	12"	24"	36"	60"
\$119.67	\$123.01	\$129.66	\$136.33	\$149.67
- See Web				
BMA JACK TO TNC MALE				
Formable Cable Assemblies				
PE-SR402FLJ Coax, 50 Ohm				
Part No. <b>PE3C4917</b>				
1 piece price shown. See web or call for volume pricing.				
Cable Dia.	Attn. @ 1 GHz	Power @ 1 GHz		
0.161" dia.	12 dB/100ft	303 W		
6"	12"	24"	36"	60"
\$114.36	\$118.03	\$125.37	\$132.69	\$147.35
- See Web				
PE-SR405FLJ Coax, 50 Ohm				
Part No. <b>PE3C4865</b>				
1 piece price shown. See web or call for volume pricing.				
Cable Dia.	Attn. @ 1 GHz	Power @ 1 GHz		
0.105" dia.	20 dB/100ft	122 W		
6"	12"	24"	36"	60"
\$103.52	\$107.29	\$114.81	\$122.33	\$137.38
- See Web				
Flexible Cable Assemblies				
RG316/U Coax, 50 Ohm				
Part No. <b>PE3C4946</b>				
1 piece price shown. See web or call for volume pricing.				
Cable Dia.	Attn. @ 1 GHz	Power @ 1 GHz		
0.098" dia.	58 dB/100ft	160 W		
6"	12"	24"	36"	60"
\$116.69	\$118.10	\$120.89	\$123.69	\$129.30
- See Web				
RG400/U Coax, 50 Ohm				
Part No. <b>PE3C4962</b>				
1 piece price shown. See web or call for volume pricing.				
Cable Dia.	Attn. @ 1 GHz	Power @ 1 GHz		
0.195" dia.	15 dB/100ft	600 W		
6"	12"	24"	36"	60"
\$132.09	\$135.48	\$142.23	\$149.00	\$162.53
- See Web				
LMR-100A-PVC Coax, 50 Ohm				
Part No. <b>PE3C4932</b>				
1 piece price shown. See web or call for volume pricing.				
Cable Dia.	Attn. @ 1 GHz	Power @ 1 GHz		
0.110" dia.	24 dB/100ft	W		
6"	12"	24"	36"	60"
\$110.88	\$111.26	\$111.99	\$112.73	\$114.21
- See Web				
Semi-Rigid Cable Assemblies				
RG405/U Coax, 50 Ohm				
Part No. <b>PE3C4892</b>				
1 piece price shown. See web or call for volume pricing.				
Cable Dia.	Attn. @ 1 GHz	Power @ 1 GHz		
" dia.	22 dB/100ft	130 W		
6"	12"	24"	36"	60"
\$103.09	\$106.42	\$113.08	\$119.76	\$133.10
- See Web				
BMA JACK BULKHEAD TO BMA JACK BULKHEAD				
SEE MOUNTING HOLE SECTION ON PAGE 369				
Formable Cable Assemblies				
PE-SR405FLJ Coax, 50 Ohm				
Part No. <b>PE3C4846</b>				
1 piece price shown. See web or call for volume pricing.				
Cable Dia.	Attn. @ 1 GHz	Power @ 1 GHz		
0.105" dia.	20 dB/100ft	122 W		
6"	12"	24"	36"	60"
\$110.34	\$114.10	\$121.63	\$129.16	\$144.20
- See Web				
Semi-Rigid Cable Assemblies				
RG405/U Coax, 50 Ohm				
Part No. <b>PE3C4874</b>				
1 piece price shown. See web or call for volume pricing.				
Cable Dia.	Attn. @ 1 GHz	Power @ 1 GHz		
" dia.	22 dB/100ft	130 W		
6"	12"	24"	36"	60"
\$109.92	\$113.25	\$119.91	\$126.58	\$139.91
- See Web				
BMA JACK 2 HOLE FLANGE TO BMA JACK 2 HOLE FLANGE				
SEE MOUNTING HOLE SECTION ON PAGE 369				
Formable Cable Assemblies				

Cable Assemblies

See Our Website For Current Pricing & Real-Time Stock Availability!

Continued on Next Page

For Custom Lengths, Metric Lengths or Special Configurations, Please call (949) 261-1920

Technical Support  
+1 (949) 261-1920

Same-Day Shipping,  
Even Custom Cable Assemblies

For our complete selection of cable assemblies, please visit our website

Cable Assemblies

See Our Website For Current Pricing & Real-Time Stock Availability!

PE-SR402FLJ Coax, 50 Ohm				
Part No. <a href="#">PE3C4900</a>	Cable Dia.	Attn. @ 1 GHz	Power @ 1 GHz	
1 piece price shown. See web or call for volume pricing.				
6"	12"	24"	36"	60"
\$98.55	\$102.22	\$109.54	\$116.88	\$131.54
				Custom Len. See Web
PE-SR405FLJ Coax, 50 Ohm				
Part No. <a href="#">PE3C4845</a>	Cable Dia.	Attn. @ 1 GHz	Power @ 1 GHz	
1 piece price shown. See web or call for volume pricing.				
6"	12"	24"	36"	60"
\$121.83	\$125.60	\$133.13	\$140.65	\$155.70
				Custom Len. See Web
Flexible Cable Assemblies				
RG316/U Coax, 50 Ohm				
Part No. <a href="#">PE3C4937</a>	Cable Dia.	Attn. @ 1 GHz	Power @ 1 GHz	
1 piece price shown. See web or call for volume pricing.				
6"	12"	24"	36"	60"
\$100.41	\$101.81	\$104.61	\$107.41	\$113.02
				Custom Len. See Web
LMR-100A-PVC Coax, 50 Ohm				
Part No. <a href="#">PE3C4922</a>	Cable Dia.	Attn. @ 1 GHz	Power @ 1 GHz	
1 piece price shown. See web or call for volume pricing.				
6"	12"	24"	36"	60"
\$94.59	\$94.97	\$95.71	\$96.45	\$97.92
				Custom Len. See Web
Semi-Rigid Cable Assemblies				
RG405/U Coax, 50 Ohm				
Part No. <a href="#">PE3C4873</a>	Cable Dia.	Attn. @ 1 GHz	Power @ 1 GHz	
1 piece price shown. See web or call for volume pricing.				
6"	12"	24"	36"	60"
\$121.41	\$124.74	\$131.40	\$138.07	\$151.41
				Custom Len. See Web
BMA JACK 2 HOLE FLANGE TO BNC MALE				
SEE MOUNTING HOLE SECTION ON PAGE 369				
Formable Cable Assemblies				
PE-SR402FLJ Coax, 50 Ohm				
Part No. <a href="#">PE3C4919</a>	Cable Dia.	Attn. @ 1 GHz	Power @ 1 GHz	
1 piece price shown. See web or call for volume pricing.				
6"	12"	24"	36"	60"
\$83.84	\$87.50	\$94.83	\$102.16	\$116.83
				Custom Len. See Web
BMA JACK 2 HOLE FLANGE TO N MALE				
SEE MOUNTING HOLE SECTION ON PAGE 369				
Formable Cable Assemblies				
PE-SR402FLJ Coax, 50 Ohm				
Part No. <a href="#">PE3C4913</a>	Cable Dia.	Attn. @ 1 GHz	Power @ 1 GHz	
1 piece price shown. See web or call for volume pricing.				
6"	12"	24"	36"	60"
\$76.42	\$80.09	\$87.42	\$94.75	\$109.41
				Custom Len. See Web
PE-SR405FLJ Coax, 50 Ohm				
Part No. <a href="#">PE3C4861</a>	Cable Dia.	Attn. @ 1 GHz	Power @ 1 GHz	
1 piece price shown. See web or call for volume pricing.				
6"	12"	24"	36"	60"
\$88.11	\$91.88	\$99.40	\$106.92	\$121.98
				Custom Len. See Web
Semi-Rigid Cable Assemblies				
RG405/U Coax, 50 Ohm				
Part No. <a href="#">PE3C4888</a>	Cable Dia.	Attn. @ 1 GHz	Power @ 1 GHz	
1 piece price shown. See web or call for volume pricing.				
6"	12"	24"	36"	60"
\$87.69	\$91.03	\$97.68	\$104.35	\$117.69
				Custom Len. See Web
BMA JACK 2 HOLE FLANGE TO SMA MALE				
SEE MOUNTING HOLE SECTION ON PAGE 369				
Formable Cable Assemblies				
PE-SR402FLJ Coax, 50 Ohm				
Part No. <a href="#">PE3C4907</a>	Cable Dia.	Attn. @ 1 GHz	Power @ 1 GHz	
1 piece price shown. See web or call for volume pricing.				
6"	12"	24"	36"	60"
\$68.73	\$72.40	\$79.73	\$87.06	\$101.72
				Custom Len. See Web
PE-SR405FLJ Coax, 50 Ohm				
Part No. <a href="#">PE3C4855</a>	Cable Dia.	Attn. @ 1 GHz	Power @ 1 GHz	
1 piece price shown. See web or call for volume pricing.				
6"	12"	24"	36"	60"
\$81.18	\$84.95	\$92.47	\$99.99	\$115.05
				Custom Len. See Web
Semi-Rigid Cable Assemblies				
RG402/U Coax, 50 Ohm				
Part No. <a href="#">PE3W06981</a>	Cable Dia.	Attn. @ 1 GHz	Power @ 1 GHz	
1 piece price shown. See web or call for volume pricing.				
12"	24"	36"	48"	60"
\$91.59	\$99.18	\$106.78	\$114.37	\$121.97
				50CM Custom Len. See Web
RG405/U Coax, 50 Ohm				

Part No. <a href="#">PE3C4882</a>	Cable Dia.	Attn. @ 1 GHz	Power @ 1 GHz	
1 piece price shown. See web or call for volume pricing.				
6"	12"	24"	36"	60"
\$80.76	\$84.10	\$90.79	\$97.42	\$110.76
				22 dB/100ft 130 W Custom Len. See Web
BMA JACK 2 HOLE FLANGE TO SMA MALE RIGHT ANGLE				
SEE MOUNTING HOLE SECTION ON PAGE 369				
Formable Cable Assemblies				
PE-SR402FLJ Coax, 50 Ohm				
Part No. <a href="#">PE3C4910</a>	Cable Dia.	Attn. @ 1 GHz	Power @ 1 GHz	
1 piece price shown. See web or call for volume pricing.				
6"	12"	24"	36"	60"
\$71.38	\$75.06	\$82.38	\$89.72	\$104.37
				12 dB/100ft 303 W Custom Len. See Web
PE-SR405FLJ Coax, 50 Ohm				
Part No. <a href="#">PE3C4858</a>	Cable Dia.	Attn. @ 1 GHz	Power @ 1 GHz	
1 piece price shown. See web or call for volume pricing.				
6"	12"	24"	36"	60"
\$83.08	\$86.84	\$94.37	\$101.89	\$116.94
				20 dB/100ft 122 W Custom Len. See Web
Semi-Rigid Cable Assemblies				
RG405/U Coax, 50 Ohm				
Part No. <a href="#">PE3C4885</a>	Cable Dia.	Attn. @ 1 GHz	Power @ 1 GHz	
1 piece price shown. See web or call for volume pricing.				
6"	12"	24"	36"	60"
\$82.65	\$85.99	\$92.65	\$99.32	\$112.66
				22 dB/100ft 130 W Custom Len. See Web
BMA JACK 2 HOLE FLANGE TO SMP FEMALE				
SEE MOUNTING HOLE SECTION ON PAGE 369				
Formable Cable Assemblies				
PE-SR405FLJ Coax, 50 Ohm				
Part No. <a href="#">PE3C4867</a>	Cable Dia.	Attn. @ 1 GHz	Power @ 1 GHz	
1 piece price shown. See web or call for volume pricing.				
6"	12"	24"	36"	60"
\$89.77	\$93.53	\$101.06	\$108.59	\$123.63
				0.105" dia. 20 dB/100ft 122 W Custom Len. See Web
Semi-Rigid Cable Assemblies				
RG405/U Coax, 50 Ohm				
Part No. <a href="#">PE3C4894</a>	Cable Dia.	Attn. @ 1 GHz	Power @ 1 GHz	
1 piece price shown. See web or call for volume pricing.				
6"	12"	24"	36"	60"
\$89.34	\$63.45	\$94.34	\$106.01	\$119.34
				22 dB/100ft 130 W Custom Len. See Web
BMA JACK 2 HOLE FLANGE TO SMP FEMALE RIGHT ANGLE				
SEE MOUNTING HOLE SECTION ON PAGE 369				
Formable Cable Assemblies				
PE-SR405FLJ Coax, 50 Ohm				
Part No. <a href="#">PE3C4870</a>	Cable Dia.	Attn. @ 1 GHz	Power @ 1 GHz	
1 piece price shown. See web or call for volume pricing.				
6"	12"	24"	36"	60"
\$101.52	\$105.29	\$112.81	\$120.34	\$135.39
				0.105" dia. 20 dB/100ft 122 W Custom Len. See Web
Semi-Rigid Cable Assemblies				
RG405/U Coax, 50 Ohm				
Part No. <a href="#">PE3C4897</a>	Cable Dia.	Attn. @ 1 GHz	Power @ 1 GHz	
1 piece price shown. See web or call for volume pricing.				
6"	12"	24"	36"	60"
\$101.11	\$104.44	\$111.09	\$117.76	\$131.10
				22 dB/100ft 130 W Custom Len. See Web
BMA JACK 2 HOLE FLANGE TO TNC MALE				
SEE MOUNTING HOLE SECTION ON PAGE 369				
Formable Cable Assemblies				
PE-SR402FLJ Coax, 50 Ohm				
Part No. <a href="#">PE3C4916</a>	Cable Dia.	Attn. @ 1 GHz	Power @ 1 GHz	
1 piece price shown. See web or call for volume pricing.				
6"	12"	24"	36"	60"
\$73.26	\$76.93	\$84.25	\$91.59	\$106.25
				0.161" dia. 12 dB/100ft 303 W Custom Len. See Web
PE-SR405FLJ Coax, 50 Ohm				
Part No. <a href="#">PE3C4864</a>	Cable Dia.	Attn. @ 1 GHz	Power @ 1 GHz	
1 piece price shown. See web or call for volume pricing.				
6"	12"	24"	36"	60"
\$84.95	\$88.72	\$96.24	\$103.76	\$118.81
				0.105" dia. 20 dB/100ft 122 W Custom Len. See Web
Semi-Rigid Cable Assemblies				
RG405/U Coax, 50 Ohm				
Part No. <a href="#">PE3C4891</a>	Cable Dia.	Attn. @ 1 GHz	Power @ 1 GHz	
1 piece price shown. See web or call for volume pricing.				
6"	12"	24"	36"	60"
\$84.52	\$87.86	\$94.52	\$101.19	\$114.53
				22 dB/100ft 130 W Custom Len. See Web

\*Coax Performance at 1 GHz Notes: Cable assembly max frequency may be lower than connector or coax max frequency



For our complete selection of cable assemblies, please visit our website

<b>BMA JACK RIGHT ANGLE 2 HOLE FLANGE TO BMA JACK RIGHT ANGLE 2</b>						
SEE MOUNTING HOLE SECTION ON PAGE 369						
<b>Formable Cable Assemblies</b>						
<b>PE-SR402FLJ Coax, 50 Ohm</b>						
Part No. <b>PE3C4902</b>	Cable Dia.		Attn. @ 1 GHz	Power @ 1 GHz		
1 piece price shown. See web or call for volume pricing.						
6"	12"	24"	36"	60"	12 dB/100ft	303 W
\$156.64	\$160.31	\$135.16	\$174.97	\$189.63	-	Custom Len. See Web
<b>PE-SR405FLJ Coax, 50 Ohm</b>						
Part No. <b>PE3C4849</b>	Cable Dia.		Attn. @ 1 GHz	Power @ 1 GHz		
1 piece price shown. See web or call for volume pricing.						
6"	12"	24"	36"	60"	20 dB/100ft	122 W
\$145.61	\$149.38	\$156.90	\$164.42	\$179.48	-	Custom Len. See Web
<b>Flexible Cable Assemblies</b>						
<b>RG400/U Coax, 50 Ohm</b>						
Part No. <b>PE3C4952</b>	Cable Dia.		Attn. @ 1 GHz	Power @ 1 GHz		
1 piece price shown. See web or call for volume pricing.						
6"	12"	24"	36"	60"	15 dB/100ft	600 W
\$128.80	\$132.19	\$138.96	\$145.72	\$159.25	-	Custom Len. See Web
<b>Semi-Rigid Cable Assemblies</b>						
<b>RG405/U Coax, 50 Ohm</b>						
Part No. <b>PE3C4876</b>	Cable Dia.		Attn. @ 1 GHz	Power @ 1 GHz		
1 piece price shown. See web or call for volume pricing.						
6"	12"	24"	36"	60"	22 dB/100ft	130 W
\$145.19	\$148.53	\$155.17	\$161.85	\$175.19	-	Custom Len. See Web
<b>BNC MALE TO BNC MALE</b>						
<b>Standard Flexible Cable Assemblies</b>						
<b>M17/60-RG142-27478 Coax, 50 Ohm</b>						
Part No. <b>PE3M0001</b>	Cable Dia.		Attn. @ 1 GHz	Power @ 1 GHz		
1 piece price shown. See web or call for volume pricing.						
12"	18"	24"	30"	36"	48"	Custom Len. W
\$127.95	\$130.68	\$133.41	\$136.13	\$138.86	\$144.32	See Web
<b>M17/84-RG223-0XDS2 Coax, 50 Ohm</b>						
Part No. <b>PE3M0029</b>	Cable Dia.		Attn. @ 1 GHz	Power @ 1 GHz		
1 piece price shown. See web or call for volume pricing.						
12"	18"	24"	30"	36"	48"	Custom Len. W
\$132.25	\$137.13	\$142.01	\$146.88	\$151.77	\$161.52	See Web
<b>M17/128-RG400-27478 Coax, 50 Ohm</b>						
Part No. <b>PE3M0057</b>	Cable Dia.		Attn. @ 1 GHz	Power @ 1 GHz		
1 piece price shown. See web or call for volume pricing.						
12"	18"	24"	30"	36"	48"	Custom Len. W
\$129.44	\$132.91	\$136.38	\$139.85	\$143.32	\$150.26	See Web
<b>M17/113-RG316-27478 Coax, 50 Ohm</b>						
Part No. <b>PE3M0085</b>	Cable Dia.		Attn. @ 1 GHz	Power @ 1 GHz		
1 piece price shown. See web or call for volume pricing.						
6"	8"	12"	16"	18"	24"	Custom Len. W
\$184.05	\$184.38	\$185.06	\$185.71	\$186.05	\$187.06	See Web
<b>M17/119-RG174-0XDS2 Coax, 50 Ohm</b>						
Part No. <b>PE3M0100</b>	Cable Dia.		Attn. @ 1 GHz	Power @ 1 GHz		
1 piece price shown. See web or call for volume pricing.						
6"	8"	12"	16"	18"	24"	Custom Len. W
\$183.44	\$183.56	\$183.83	\$184.08	\$184.21	\$184.61	See Web
<b>M17/28-RG058-0XDS2 Coax, 50 Ohm</b>						
Part No. <b>PE3M0115</b>	Cable Dia.		Attn. @ 1 GHz	Power @ 1 GHz		
1 piece price shown. See web or call for volume pricing.						
12"	18"	24"	30"	36"	48"	Custom Len. W
\$129.35	\$129.94	\$130.54	\$131.13	\$131.73	\$132.93	See Web
<b>BNC MALE TO N MALE</b>						
<b>Standard Flexible Cable Assemblies</b>						
<b>M17/60-RG142-27478 Coax, 50 Ohm</b>						
Part No. <b>PE3M0002</b>	Cable Dia.		Attn. @ 1 GHz	Power @ 1 GHz		
1 piece price shown. See web or call for volume pricing.						
12"	18"	24"	30"	36"	48"	Custom Len. W
\$139.96	\$142.69	\$145.42	\$148.14	\$151.21	\$156.33	See Web
<b>M17/84-RG223-0XDS2 Coax, 50 Ohm</b>						
Part No. <b>PE3M0030</b>	Cable Dia.		Attn. @ 1 GHz	Power @ 1 GHz		
1 piece price shown. See web or call for volume pricing.						
12"	18"	24"	30"	36"	48"	Custom Len. W
\$144.27	\$149.14	\$154.02	\$158.89	\$163.78	\$173.53	See Web
<b>M17/128-RG400-27478 Coax, 50 Ohm</b>						
Part No. <b>PE3M0058</b>	Cable Dia.		Attn. @ 1 GHz	Power @ 1 GHz		
1 piece price shown. See web or call for volume pricing.						
12"	18"	24"	30"	36"	48"	Custom Len. W
\$141.45	\$144.92	\$148.39	\$151.86	\$155.33	\$162.27	See Web

<b>BNC MALE TO N FEMALE</b>						
<b>Standard Flexible Cable Assemblies</b>						
<b>M17/60-RG142-27478 Coax, 50 Ohm</b>						
Part No. <b>PE3M0003</b>	Cable Dia.		Attn. @ 1 GHz	Power @ 1 GHz		
1 piece price shown. See web or call for volume pricing.						
12"	18"	24"	30"	36"	48"	Custom Len. W
\$149.54	\$152.27	\$155.00	\$157.72	\$160.45	\$165.91	See Web
<b>M17/84-RG223-0XDS2 Coax, 50 Ohm</b>						
Part No. <b>PE3M0031</b>	Cable Dia.		Attn. @ 1 GHz	Power @ 1 GHz		
1 piece price shown. See web or call for volume pricing.						
12"	18"	24"	30"	36"	48"	Custom Len. W
\$153.84	\$158.72	\$163.60	\$168.47	\$173.36	\$183.11	See Web
<b>M17/128-RG400-27478 Coax, 50 Ohm</b>						
Part No. <b>PE3M0059</b>	Cable Dia.		Attn. @ 1 GHz	Power @ 1 GHz		
1 piece price shown. See web or call for volume pricing.						
12"	18"	24"	30"	36"	48"	Custom Len. W
\$151.03	\$154.50	\$157.97	\$161.44	\$164.91	\$171.85	See Web
<b>BNC MALE TO N FEMALE BULKHEAD</b>						
SEE MOUNTING HOLE SECTION ON PAGE 369						
<b>Standard Flexible Cable Assemblies</b>						
<b>M17/60-RG142-27478 Coax, 50 Ohm</b>						
Part No. <b>PE3M0004</b>	Cable Dia.		Attn. @ 1 GHz	Power @ 1 GHz		
1 piece price shown. See web or call for volume pricing.						
12"	18"	24"	30"	36"	48"	Custom Len. W
\$153.39	\$156.11	\$158.84	\$161.56	\$164.30	\$169.75	See Web
<b>M17/84-RG223-0XDS2 Coax, 50 Ohm</b>						
Part No. <b>PE3M0032</b>	Cable Dia.		Attn. @ 1 GHz	Power @ 1 GHz		
1 piece price shown. See web or call for volume pricing.						
12"	18"	24"	30"	36"	48"	Custom Len. W
\$157.69	\$162.56	\$167.45	\$172.32	\$177.20	\$186.96	See Web
<b>M17/128-RG400-27478 Coax, 50 Ohm</b>						
Part No. <b>PE3M0060</b>	Cable Dia.		Attn. @ 1 GHz	Power @ 1 GHz		
1 piece price shown. See web or call for volume pricing.						
12"	18"	24"	30"	36"	48"	Custom Len. W
\$154.87	\$158.34	\$161.81	\$165.28	\$168.75	\$175.69	See Web
<b>BNC MALE TO SMA MALE</b>						
<b>Standard Flexible Cable Assemblies</b>						
<b>M17/60-RG142-27478 Coax, 50 Ohm</b>						
Part No. <b>PE3M0005</b>	Cable Dia.		Attn. @ 1 GHz	Power @ 1 GHz		
1 piece price shown. See web or call for volume pricing.						
12"	18"	24"	30"	36"	48"	Custom Len. W
\$173.28	\$176.01	\$178.74	\$181.46	\$184.19	\$189.65	See Web
<b>M17/84-RG223-0XDS2 Coax, 50 Ohm</b>						
Part No. <b>PE3M0033</b>	Cable Dia.		Attn. @ 1 GHz	Power @ 1 GHz		
1 piece price shown. See web or call for volume pricing.						
12"	18"	24"	30"	36"	48"	Custom Len. W
\$177.59	\$182.46	\$187.34	\$192.22	\$197.10	\$206.85	See Web
<b>M17/128-RG400-27478 Coax, 50 Ohm</b>						
Part No. <b>PE3M0061</b>	Cable Dia.		Attn. @ 1 GHz	Power @ 1 GHz		
1 piece price shown. See web or call for volume pricing.						
12"	18"	24"	30"	36"	48"	Custom Len. W
\$174.77	\$178.24	\$181.71	\$185.18	\$188.65	\$195.59	See Web
<b>M17/113-RG316-27478 Coax, 50 Ohm</b>						
Part No. <b>PE3M0086</b>	Cable Dia.		Attn. @ 1 GHz	Power @ 1 GHz		
1 piece price shown. See web or call for volume pricing.						
6"	8"	12"	16"	18"	24"	Custom Len. W
\$178.61	\$178.94	\$179.61	\$180.28	\$180.62	\$181.62	See Web
<b>M17/119-RG174-0XDS2 Coax, 50 Ohm</b>						
Part No. <b>PE3M0101</b>	Cable Dia.		Attn. @ 1 GHz	Power @ 1 GHz		
1 piece price shown. See web or call for volume pricing.						
6"	8"	12"	16"	18"	24"	Custom Len. W
\$178.00	\$178.13	\$178.39	\$178.64	\$178.78	\$179.17	See Web
<b>M17/28-RG058-0XDS2 Coax, 50 Ohm</b>						
Part No. <b>PE3M0116</b>	Cable Dia.		Attn. @ 1 GHz	Power @ 1 GHz		
1 piece price shown. See web or call for volume pricing.						
12"	18"	24"	30"	36"	48"	Custom Len. W
\$226.23	\$226.82	\$227.43	\$228.02	\$228.62	\$229.82	See Web
<b>BNC MALE TO SMA MALE RIGHT ANGLE</b>						
<b>Standard Flexible Cable Assemblies</b>						
<b>M17/60-RG142-27478 Coax, 50 Ohm</b>						

Cable Assemblies

See Our Website For Current Pricing & Real-Time Stock Availability!

Continued on Next Page

For Custom Lengths, Metric Lengths or Special Configurations, Please call (949) 261-1920

Technical Support  
+1 (949) 261-1920

Same-Day Shipping,  
Even Custom Cable Assemblies

For our complete selection of cable assemblies, please visit our website

Cable Assemblies

See Our Website For Current Pricing & Real-Time Stock Availability!

Part No.	Cable Dia.				Attn. @ 1 GHz	Power @ 1 GHz
<b>PE3M0006</b>	0.195" dia.				dB/100ft	W
1 piece price shown. See web or call for volume pricing.	12"	18"	24"	30"	36"	48"
\$209.37	\$212.09	\$214.82	\$217.55	\$220.28	\$225.73	See Web
<b>M17/84-RG223-0XDS2 Coax, 50 Ohm</b>						
<b>PE3M0034</b>	0.212" dia.				dB/100ft	W
1 piece price shown. See web or call for volume pricing.	12"	18"	24"	30"	36"	48"
\$213.67	\$218.54	\$223.43	\$228.30	\$233.18	\$242.94	See Web
<b>M17/128-RG400-27478 Coax, 50 Ohm</b>						
<b>PE3M0062</b>	0.195" dia.				dB/100ft	W
1 piece price shown. See web or call for volume pricing.	12"	18"	24"	30"	36"	48"
\$210.85	\$214.31	\$217.80	\$221.26	\$224.74	\$231.68	See Web
<b>M17/113-RG316-27478 Coax, 50 Ohm</b>						
<b>PE3M0087</b>	0.098" dia.				dB/100ft	W
1 piece price shown. See web or call for volume pricing.	6"	8"	12"	16"	18"	24"
\$194.47	\$194.80	\$195.48	\$196.13	\$196.47	\$197.48	See Web
<b>M17/119-RG174-0XDS2 Coax, 50 Ohm</b>						
<b>PE3M0102</b>	0.110" dia.				dB/100ft	W
1 piece price shown. See web or call for volume pricing.	6"	8"	12"	16"	18"	24"
\$193.86	\$193.98	\$194.25	\$194.50	\$194.64	\$195.05	See Web
<b>M17/28-RG058-0XDS2 Coax, 50 Ohm</b>						
<b>PE3M0117</b>	0.195" dia.				dB/100ft	W
1 piece price shown. See web or call for volume pricing.	12"	18"	24"	30"	36"	48"
\$165.56	\$166.16	\$166.76	\$167.35	\$167.95	\$169.15	See Web

**BNC MALE TO SMA FEMALE BULKHEAD**

SEE MOUNTING HOLE SECTION ON PAGE 369



**Standard Flexible Cable Assemblies**

Part No.	Cable Dia.				Attn. @ 1 GHz	Power @ 1 GHz
<b>PE3M0088</b>	0.098" dia.				dB/100ft	W
1 piece price shown. See web or call for volume pricing.	6"	8"	12"	16"	18"	24"
\$185.23	\$185.56	\$186.23	\$186.90	\$187.24	\$188.24	See Web
<b>M17/119-RG174-0XDS2 Coax, 50 Ohm</b>						
<b>PE3M0103</b>	0.110" dia.				dB/100ft	W
1 piece price shown. See web or call for volume pricing.	6"	8"	12"	16"	18"	24"
\$184.62	\$184.74	\$185.00	\$185.26	\$185.40	\$185.78	See Web

**BNC MALE TO TNC MALE**



**Standard Flexible Cable Assemblies**

Part No.	Cable Dia.				Attn. @ 1 GHz	Power @ 1 GHz
<b>PE3M0007</b>	0.195" dia.				dB/100ft	W
1 piece price shown. See web or call for volume pricing.	12"	18"	24"	30"	36"	48"
\$142.57	\$145.29	\$148.19	\$150.75	\$153.48	\$158.94	See Web
<b>M17/84-RG223-0XDS2 Coax, 50 Ohm</b>						
<b>PE3M0035</b>	0.212" dia.				dB/100ft	W
1 piece price shown. See web or call for volume pricing.	12"	18"	24"	30"	36"	48"
\$146.87	\$151.75	\$156.63	\$161.50	\$166.39	\$176.14	See Web
<b>M17/128-RG400-27478 Coax, 50 Ohm</b>						
<b>PE3M0063</b>	0.195" dia.				dB/100ft	W
1 piece price shown. See web or call for volume pricing.	12"	18"	24"	30"	36"	48"
\$144.06	\$147.53	\$151.00	\$154.47	\$157.94	\$164.88	See Web
<b>M17/113-RG316-27478 Coax, 50 Ohm</b>						
<b>PE3M0089</b>	0.098" dia.				dB/100ft	W
1 piece price shown. See web or call for volume pricing.	6"	8"	12"	16"	18"	24"
\$186.19	\$186.52	\$187.20	\$187.85	\$188.19	\$189.20	See Web
<b>M17/119-RG174-0XDS2 Coax, 50 Ohm</b>						
<b>PE3M0104</b>	0.110" dia.				dB/100ft	W
1 piece price shown. See web or call for volume pricing.	6"	8"	12"	16"	18"	24"
\$185.58	\$185.74	\$185.97	\$186.22	\$186.36	\$186.75	See Web
<b>M17/28-RG058-0XDS2 Coax, 50 Ohm</b>						
<b>PE3M0118</b>	0.195" dia.				dB/100ft	W
1 piece price shown. See web or call for volume pricing.	12"	18"	24"	30"	36"	48"
\$194.64	\$195.23	\$195.83	\$196.42	\$197.03	\$198.22	See Web

**BNC MALE TO BNC MALE**



**Flexible Cable Assemblies**

Part No.	Cable Dia.				Attn. @ 1 GHz	Power @ 1 GHz
<b>PE34035</b>	0.195" dia.				13 dB/100ft	650 W
1 piece price shown. See web or call for volume pricing.	12"	24"	36"	48"	60"	Custom Len.
\$24.42	\$34.00	\$43.58	\$53.71	\$63.47	-	See Web
<b>PE-P195 Coax, 50 Ohm</b>						
<b>PE3C0054</b>	0.195" dia.				12 dB/100ft	W
1 piece price shown. See web or call for volume pricing.	12"	24"	36"	48"	60"	Custom Len.
\$24.00	\$24.72	\$25.45	\$26.21	\$26.94	-	See Web
<b>LMR-195 Coax, 50 Ohm</b>						
<b>Low Loss Flexible Cable Assemblies</b>						
<b>PE-C195 Coax, 50 Ohm</b>						
<b>PE36066</b>	0.195" dia.				11 dB/100ft	150 W
1 piece price shown. See web or call for volume pricing.	12"	24"	36"	48"	60"	Custom Len.
\$28.23	\$29.01	\$29.80	\$30.62	\$31.42	-	See Web
<b>PE-C200 Coax, 50 Ohm</b>						
<b>PE35256</b>	0.195" dia.				11 dB/100ft	170 W
1 piece price shown. See web or call for volume pricing.	12"	24"	36"	48"	60"	Custom Len.
\$46.09	\$48.52	\$50.53	\$56.99	\$61.19	-	See Web
<b>PE-C240 Coax, 50 Ohm</b>						
<b>PE36219</b>	0.240" dia.				9 dB/100ft	250 W
1 piece price shown. See web or call for volume pricing.	12"	24"	36"	48"	60"	Custom Len.
\$53.39	\$59.87	\$61.00	\$57.82	\$63.36	-	See Web
<b>PE-C300 Coax, 50 Ohm</b>						
<b>PE35729</b>	0.300" dia.				6 dB/100ft	350 W
1 piece price shown. See web or call for volume pricing.	12"	24"	36"	48"	60"	Custom Len.
\$51.88	\$54.71	\$57.55	\$60.38	\$68.35	-	See Web
<b>PE-C400 Coax, 50 Ohm</b>						
<b>PE35874</b>	0.400" dia.				4 dB/100ft	550 W
1 piece price shown. See web or call for volume pricing.	12"	24"	36"	48"	60"	Custom Len.
\$83.68	\$85.00	\$88.54	\$93.35	\$98.15	-	See Web
<b>LMR-240 Coax, 50 Ohm</b>						
<b>PE3W01041</b>	0.240" dia.				5 dB/100ft	W
1 piece price shown. See web or call for volume pricing.	12"	24"	36"	48"	60"	50CM Custom Len.
\$52.39	\$53.32	\$54.27	\$55.21	\$56.15	\$52.99	See Web
<b>LMR-400-DB Coax, 50 Ohm</b>						
<b>PE3W01357</b>	0.405" dia.				4 dB/100ft	W
1 piece price shown. See web or call for volume pricing.	12"	24"	36"	48"	60"	50CM Custom Len.
\$54.13	\$59.71	\$61.04	\$62.37	\$63.70	\$59.23	See Web
<b>PE-SF200LL Coax, 50 Ohm</b>						
<b>PE3TC1100</b>	0.185" dia.				dB/100ft	W
1 piece price shown. See web or call for volume pricing.	24"	36"	48"	72"	100CM	200CM Custom Len.
\$68.40	\$79.65	\$90.91	\$113.44	\$82.82	\$119.76	See Web
<b>LMR-200-UF Coax, 50 Ohm</b>						
<b>PE3C2220</b>	" dia.				dB/100ft	W
1 piece price shown. See web or call for volume pricing.	12"	24"	36"	48"	60"	50CM Custom Len.
\$45.51	\$47.68	\$49.85	\$52.02	\$54.19	\$46.89	See Web
<b>Standard Formable Cable Assemblies</b>						
<b>PE-SR401FL Coax, 50 Ohm</b>						
<b>PE34166</b>	" dia.				8 dB/100ft	1400 W
1 piece price shown. See web or call for volume pricing.	6"	12"	18"	24"	36"	48"
\$129.00	\$136.49	\$143.94	\$151.44	\$166.39	\$181.33	See Web
<b>PE-SR402FL Coax, 50 Ohm</b>						
<b>PE3462</b>	" dia.				12 dB/100ft	450 W
1 piece price shown. See web or call for volume pricing.	6"	12"	18"	24"	36"	48"
\$86.70	\$90.62	\$94.66	\$98.71	\$98.98	\$115.33	See Web
<b>PE-SR405FL Coax, 50 Ohm</b>						
<b>PE3776</b>	" dia.				23 dB/100ft	130 W
1 piece price shown. See web or call for volume pricing.	6"	12"	18"	24"	36"	48"
\$85.59	\$92.44	\$90.93	\$96.28	\$115.13	\$117.67	See Web
<b>Standard Flexible Cable Assemblies</b>						
<b>RG8A/U Coax, 50 Ohm</b>						
<b>PE3807</b>	0.405" dia.				8 dB/100ft	190 W
1 piece price shown. See web or call for volume pricing.	12"	24"	36"	48"	60"	72"
\$77.00	\$79.84	\$87.76	\$85.50	\$88.34	\$97.27	See Web
<b>RG8X Coax, 50 Ohm</b>						
<b>PE3264</b>	0.242" dia.				14 dB/100ft	60 W
1 piece price shown. See web or call for volume pricing.	12"	24"	36"	48"	60"	Custom Len.
\$65.25	\$74.00	\$77.53	\$74.41	\$84.87	-	See Web
<b>RG58C/U Coax, 50 Ohm</b>						

\*Coax Performance at 1 GHz Notes: Cable assembly max frequency may be lower than connector or coax max frequency

# For our complete selection of cable assemblies, please visit our website

Part No.	Cable Dia.				Attn. @ 1 GHz	Power @ 1 GHz	
<b>Part No. PE3067</b>	1 piece price shown. See web or call for volume pricing.				0.195" dia.	20 dB/100ft	44 W
12"	18"	24"	30"	36"	48"	Custom Len.	
\$31.20	\$31.56	\$31.93	\$33.67	\$32.66	\$33.39	See Web	
<b>RG58-P Coax, 50 Ohm</b>							
<b>Part No. PE3999</b>	1 piece price shown. See web or call for volume pricing.				0.159" dia.	17 dB/100ft	632 W
12"	24"	36"	48"	60"	-	Custom Len.	
\$47.34	\$52.34	\$64.28	\$62.33	\$67.33	-	See Web	
<b>RG141A/U Coax, 50 Ohm</b>							
<b>Part No. PE35148</b>	1 piece price shown. See web or call for volume pricing.				0.190" dia.	13 dB/100ft	650 W
12"	24"	36"	48"	60"	-	Custom Len.	
\$46.65	\$53.55	\$60.45	\$67.75	\$74.80	-	See Web	
<b>RG142B/U Coax, 50 Ohm</b>							
<b>Part No. PE3495</b>	1 piece price shown. See web or call for volume pricing.				0.195" dia.	dB/100ft	650 W
12"	24"	36"	48"	60"	72"	Custom Len.	
\$31.53	\$37.61	\$43.70	\$50.13	\$56.32	\$62.52	See Web	
<b>RG174A/U Coax, 50 Ohm</b>							
<b>Part No. PE3C2295</b>	1 piece price shown. See web or call for volume pricing.				0.110" dia.	32 dB/100ft	17 W
12"	24"	36"	48"	60"	72"	Custom Len.	
\$30.29	\$30.87	\$31.44	\$32.05	\$32.65	\$33.23	See Web	
<b>RG178B/U Coax, 50 Ohm</b>							
<b>Part No. PE33130</b>	1 piece price shown. See web or call for volume pricing.				0.072" dia.	44 dB/100ft	55 W
12"	24"	36"	48"	60"	-	Custom Len.	
\$65.18	\$66.24	\$67.30	\$68.42	\$69.50	-	See Web	
<b>RG188A/U Coax, 50 Ohm</b>							
<b>Part No. PE3C2034</b>	1 piece price shown. See web or call for volume pricing.				0.110" dia.	26 dB/100ft	160 W
12"	24"	36"	48"	60"	72"	Custom Len.	
\$35.94	\$38.43	\$40.93	\$43.57	\$46.10	\$48.65	See Web	
<b>RG213/U Coax, 50 Ohm</b>							
<b>Part No. PE3749</b>	1 piece price shown. See web or call for volume pricing.				0.405" dia.	8 dB/100ft	190 W
12"	24"	36"	48"	60"	72"	Custom Len.	
\$77.29	\$78.96	\$83.96	\$82.29	\$83.94	\$85.61	See Web	
<b>RG214/U Coax, 50 Ohm</b>							
<b>Part No. PE3906</b>	1 piece price shown. See web or call for volume pricing.				0.425" dia.	7 dB/100ft	190 W
12"	24"	36"	48"	60"	72"	Custom Len.	
\$76.57	\$90.48	\$98.26	\$106.50	\$105.87	\$113.20	See Web	
<b>RG223/U Coax, 50 Ohm</b>							
<b>Part No. PE3087</b>	1 piece price shown. See web or call for volume pricing.				0.209" dia.	13 dB/100ft	50 W
12"	24"	36"	48"	60"	72"	Custom Len.	
\$30.00	\$32.89	\$35.79	\$38.70	\$41.59	\$44.49	See Web	
<b>RG303/U Coax, 50 Ohm</b>							
<b>Part No. PE3W00393</b>	1 piece price shown. See web or call for volume pricing.				0.170" dia.	14 dB/100ft	650 W
12"	24"	36"	48"	60"	50CM	Custom Len.	
\$34.88	\$41.76	\$48.64	\$55.51	\$62.39	\$39.28	See Web	
<b>RG316/U Coax, 50 Ohm</b>							
<b>Part No. PE3C2416</b>	1 piece price shown. See web or call for volume pricing.				0.102" dia.	38 dB/100ft	160 W
12"	24"	36"	48"	60"	72"	Custom Len.	
\$34.45	\$37.57	\$40.70	\$44.00	\$47.19	\$50.38	See Web	
<b>RG400/U Coax, 50 Ohm</b>							
<b>Part No. PE3582</b>	1 piece price shown. See web or call for volume pricing.				0.195" dia.	15 dB/100ft	650 W
12"	24"	36"	48"	60"	72"	Custom Len.	
\$41.98	\$49.37	\$56.77	\$64.59	\$72.14	\$79.67	See Web	
<b>Standard Semi-Rigid Cable Assemblies</b>							
<b>PE-047SR Coax, 50 Ohm</b>							
<b>Part No. PE34177</b>	1 piece price shown. See web or call for volume pricing.				" dia.	40 dB/100ft	32 W
6"	12"	18"	24"	36"	48"	Custom Len.	
\$99.14	\$99.14	\$104.26	\$109.38	\$119.62	\$129.84	See Web	
<b>PE-SR402AL Coax, 50 Ohm</b>							
<b>Part No. PE34164</b>	1 piece price shown. See web or call for volume pricing.				0.141" dia.	13 dB/100ft	450 W
6"	12"	18"	24"	36"	48"	Custom Len.	
\$74.92	\$84.25	\$84.04	\$88.61	\$97.73	\$106.85	See Web	
<b>PE-SR405AL Coax, 50 Ohm</b>							
<b>Part No. PE34162</b>	1 piece price shown. See web or call for volume pricing.				" dia.	23 dB/100ft	130 W
6"	12"	18"	24"	36"	48"	Custom Len.	
\$74.57	\$78.70	\$82.90	\$87.09	\$95.45	\$103.85	See Web	
<b>RG401/U Coax, 50 Ohm</b>							
<b>Part No. PE34170</b>	1 piece price shown. See web or call for volume pricing.				" dia.	8 dB/100ft	870 W
6"	12"	18"	24"	36"	48"	Custom Len.	
\$132.18	\$142.86	\$153.49	\$164.10	\$185.41	\$226.47	See Web	

Part No.	Cable Dia.				Attn. @ 1 GHz	Power @ 1 GHz	
<b>Part No. PE3445</b>	1 piece price shown. See web or call for volume pricing.				" dia.	12 dB/100ft	650 W
6"	12"	18"	24"	36"	48"	Custom Len.	
\$82.09	\$87.02	\$85.74	\$89.39	\$102.66	\$104.00	See Web	
<b>RG405/U Coax, 50 Ohm</b>							
<b>Part No. PE3678</b>	1 piece price shown. See web or call for volume pricing.				" dia.	22 dB/100ft	130 W
6"	12"	18"	24"	36"	48"	Custom Len.	
\$73.65	\$77.01	\$85.34	\$83.68	\$90.30	\$96.96	See Web	
<b>PE-SR401AL-STRAIGHT Coax, 50 Ohm</b>							
<b>Part No. PE34175</b>	1 piece price shown. See web or call for volume pricing.				0.250" dia.	8 dB/100ft	1400 W
6"	12"	24"	36"	48"	Custom Len.		
\$130.31	\$139.13	\$147.90	\$156.71	\$174.31	\$191.89	See Web	
<b>Standard Flexible Cable Assemblies</b>							
<b>RG55B/U Coax, 53 Ohm</b>							
<b>Part No. PE3583</b>	1 piece price shown. See web or call for volume pricing.				0.202" dia.	17 dB/100ft	53 W
12"	24"	36"	48"	60"	72"	Custom Len.	
\$32.15	\$34.73	\$37.33	\$40.06	\$42.71	\$45.35	See Web	
<b>RG59B/U Coax, 75 Ohm</b>							
<b>Part No. PE3075</b>	1 piece price shown. See web or call for volume pricing.				0.242" dia.	12 dB/100ft	74 W
12"	18"	24"	30"	36"	48"	Custom Len.	
\$26.67	\$27.99	\$27.63	\$28.12	\$28.58	\$29.55	See Web	
<b>RG179B/U Coax, 75 Ohm</b>							
<b>Part No. PE3C3349</b>	1 piece price shown. See web or call for volume pricing.				0.100" dia.	29 dB/100ft	240 W
12"	24"	36"	48"	60"	72"	Custom Len.	
\$37.35	\$36.96	\$39.32	\$41.67	\$44.04	\$50.39	See Web	
<b>RG302/U Coax, 75 Ohm</b>							
<b>Part No. PE33123</b>	1 piece price shown. See web or call for volume pricing.				0.206" dia.	13 dB/100ft	650 W
12"	24"	36"	48"	60"	-	Custom Len.	
\$30.75	\$36.62	\$42.47	\$48.34	\$54.22	-	See Web	
<b>RG62A/U Coax, 93 Ohm</b>							
<b>Part No. PE3081</b>	1 piece price shown. See web or call for volume pricing.				0.239" dia.	9 dB/100ft	77 W
12"	24"	36"	48"	60"	72"	Custom Len.	
\$32.18	\$36.29	\$37.83	\$39.46	\$41.04	\$42.61	See Web	
<b>RG180B/U Coax, 95 Ohm</b>							
<b>Part No. PE33574</b>	1 piece price shown. See web or call for volume pricing.				0.145" dia.	dB/100ft	250 W
12"	24"	36"	48"	60"	-	Custom Len.	
\$43.50	\$47.83	\$48.27	\$56.73	\$56.25	-	See Web	
<b>BNC MALE TO BNC MALE RIGHT ANGLE</b>							
<b>Low Loss Flexible Cable Assemblies</b>							
<b>PE-C240 Coax, 50 Ohm</b>							
<b>Part No. PE38997</b>	1 piece price shown. See web or call for volume pricing.				0.240" dia.	9 dB/100ft	250 W
12"	24"	36"	48"	60"	-	Custom Len.	
\$54.99	\$52.83	\$54.58	\$57.34	\$60.16	-	See Web	
<b>LMR-195 Coax, 50 Ohm</b>							
<b>Part No. PE3W01992</b>	1 piece price shown. See web or call for volume pricing.				0.195" dia.	dB/100ft	W
12"	24"	36"	48"	60"	50CM	Custom Len.	
\$43.04	\$43.76	\$44.49	\$45.22	\$45.94	\$43.50	See Web	
<b>Standard Formable Cable Assemblies</b>							
<b>PE-SR402FL Coax, 50 Ohm</b>							
<b>Part No. PE35580</b>	1 piece price shown. See web or call for volume pricing.				" dia.	12 dB/100ft	450 W
12"	24"	36"	48"	60"	-	Custom Len.	
\$86.30	\$93.84	\$101.38	\$108.92	\$116.45	-	See Web	
<b>Standard Flexible Cable Assemblies</b>							
<b>RG58C/U Coax, 50 Ohm</b>							
<b>Part No. PE3020</b>	1 piece price shown. See web or call for volume pricing.				0.195" dia.	20 dB/100ft	44 W
12"	24"	36"	48"	60"	72"	Custom Len.	
\$51.34	\$52.15	\$52.97	\$53.82	\$54.65	\$55.48	See Web	
<b>RG142B/U Coax, 50 Ohm</b>							
<b>Part No. PE3082</b>	1 piece price shown. See web or call for volume pricing.				0.195" dia.	13 dB/100ft	W
12"	24"	36"	48"	60"	72"	Custom Len.	
\$49.31	\$55.39	\$61.47	\$64.61	\$70.34	\$76.08	See Web	
<b>RG174A/U Coax, 50 Ohm</b>							
<b>Part No. PE3C3404</b>	1 piece price shown. See web or call for volume pricing.				0.110" dia.	32 dB/100ft	17 W
12"	24"	36"	48"	60"	72"	Custom Len.	
\$54.34	\$54.92	\$53.12	\$56.11	\$56.70	\$54.43	See Web	

Cable Assemblies

See Our Website For Current Pricing & Real-Time Stock Availability!

For Custom Lengths, Metric Lengths or Special Configurations, Please call (949) 261-1920



Technical Support  
+1 (949) 261-1920



Same-Day Shipping,  
Even Custom Cable Assemblies

For our complete selection of cable assemblies, please visit our website

Cable Assemblies

See Our Website For Current Pricing & Real-Time Stock Availability!

RG188A/U Coax, 50 Ohm						
Part No. <a href="#">PE3C3377</a>	Cable Dia.	Attn. @ 1 GHz	Power @ 1 GHz			
1 piece price shown. See web or call for volume pricing.						
12"	24"	36"	48"	60"	72"	Custom Len.
\$65.31	\$67.81	\$70.30	\$67.13	\$69.35	\$78.02	See Web
RG213/U Coax, 50 Ohm						
Part No. <a href="#">PE3355</a>	Cable Dia.	Attn. @ 1 GHz	Power @ 1 GHz			
1 piece price shown. See web or call for volume pricing.						
12"	24"	36"	48"	60"	72"	Custom Len.
\$86.03	\$92.98	\$89.35	\$91.03	\$92.68	\$94.34	See Web
RG214/U Coax, 50 Ohm						
Part No. <a href="#">PE3325</a>	Cable Dia.	Attn. @ 1 GHz	Power @ 1 GHz			
1 piece price shown. See web or call for volume pricing.						
12"	24"	36"	48"	60"	72"	Custom Len.
\$89.41	\$91.73	\$99.10	\$106.50	\$113.86	\$121.26	See Web
RG223/U Coax, 50 Ohm						
Part No. <a href="#">PE3689</a>	Cable Dia.	Attn. @ 1 GHz	Power @ 1 GHz			
1 piece price shown. See web or call for volume pricing.						
12"	24"	36"	48"	60"	72"	Custom Len.
\$45.49	\$48.60	\$51.72	\$55.02	\$55.34	\$58.24	See Web
RG316/U Coax, 50 Ohm						
Part No. <a href="#">PE3C3391</a>	Cable Dia.	Attn. @ 1 GHz	Power @ 1 GHz			
1 piece price shown. See web or call for volume pricing.						
12"	24"	36"	48"	60"	72"	Custom Len.
\$62.26	\$61.63	\$64.52	\$67.41	\$75.01	\$78.18	See Web
RG400/U Coax, 50 Ohm						
Part No. <a href="#">PE3116</a>	Cable Dia.	Attn. @ 1 GHz	Power @ 1 GHz			
1 piece price shown. See web or call for volume pricing.						
12"	24"	36"	48"	60"	72"	Custom Len.
\$65.72	\$73.11	\$80.50	\$88.34	\$89.87	\$103.41	See Web
RG59B/U Coax, 75 Ohm						
Part No. <a href="#">PE3508</a>	Cable Dia.	Attn. @ 1 GHz	Power @ 1 GHz			
1 piece price shown. See web or call for volume pricing.						
12"	24"	36"	48"	60"	72"	Custom Len.
\$48.54	\$45.04	\$50.62	\$46.84	\$47.74	\$53.83	See Web
RG179B/U Coax, 75 Ohm						
Part No. <a href="#">PE3C3375</a>	Cable Dia.	Attn. @ 1 GHz	Power @ 1 GHz			
1 piece price shown. See web or call for volume pricing.						
12"	24"	36"	48"	60"	72"	Custom Len.
\$60.73	\$63.09	\$71.92	\$67.83	\$70.18	\$72.55	See Web

**BNC MALE TO BNC FEMALE**



**Low Loss Flexible Cable Assemblies**

**PE-C195 Coax, 50 Ohm**

Part No. <a href="#">PE38344</a>	Cable Dia.	Attn. @ 1 GHz	Power @ 1 GHz			
1 piece price shown. See web or call for volume pricing.						
12"	24"	36"	48"	60"	72"	Custom Len.
\$28.28	\$29.00	\$29.72	\$30.43	\$31.14	-	See Web

**PE-SF200LL Coax, 50 Ohm**

Part No. <a href="#">PE3TC1101</a>	Cable Dia.	Attn. @ 1 GHz	Power @ 1 GHz			
1 piece price shown. See web or call for volume pricing.						
24"	36"	48"	72"	100CM	200CM	Custom Len.
\$68.40	\$79.65	\$90.91	\$113.44	\$82.82	\$119.76	See Web

**Standard Flexible Cable Assemblies**

**RG8A/U Coax, 50 Ohm**

Part No. <a href="#">PE3360</a>	Cable Dia.	Attn. @ 1 GHz	Power @ 1 GHz			
1 piece price shown. See web or call for volume pricing.						
12"	24"	36"	48"	60"	72"	Custom Len.
\$89.86	\$92.64	\$95.39	\$98.09	\$100.85	\$110.91	See Web

**RG58C/U Coax, 50 Ohm**

Part No. <a href="#">PE3047</a>	Cable Dia.	Attn. @ 1 GHz	Power @ 1 GHz			
1 piece price shown. See web or call for volume pricing.						
12"	24"	36"	48"	60"	72"	Custom Len.
\$38.58	\$39.39	\$40.21	\$41.07	\$41.89	\$42.72	See Web

**RG142B/U Coax, 50 Ohm**

Part No. <a href="#">PE3777</a>	Cable Dia.	Attn. @ 1 GHz	Power @ 1 GHz			
1 piece price shown. See web or call for volume pricing.						
12"	24"	36"	48"	60"	72"	Custom Len.
\$36.97	\$42.70	\$48.43	\$54.17	\$59.90	\$65.63	See Web

**RG174A/U Coax, 50 Ohm**

Part No. <a href="#">PE3C3325</a>	Cable Dia.	Attn. @ 1 GHz	Power @ 1 GHz			
1 piece price shown. See web or call for volume pricing.						
12"	24"	36"	48"	60"	72"	Custom Len.
\$41.61	\$42.18	\$40.27	\$43.38	\$43.96	\$43.96	See Web

**RG188A/U Coax, 50 Ohm**

Part No. <a href="#">PE3C3453</a>	Cable Dia.	Attn. @ 1 GHz	Power @ 1 GHz			
1 piece price shown. See web or call for volume pricing.						
12"	24"	36"	48"	60"	72"	Custom Len.
\$41.03	\$43.11	\$45.19	\$47.21	\$49.29	\$51.32	See Web

**RG213/U Coax, 50 Ohm**

Part No. <a href="#">PE3949</a>	Cable Dia.	Attn. @ 1 GHz	Power @ 1 GHz			
1 piece price shown. See web or call for volume pricing.						
12"	24"	36"	48"	60"	72"	Custom Len.
\$87.67	\$89.25	\$90.76	\$92.34	\$93.89	\$95.47	See Web

**RG223/U Coax, 50 Ohm**

Part No. <a href="#">PE3606</a>	Cable Dia.	Attn. @ 1 GHz	Power @ 1 GHz			
1 piece price shown. See web or call for volume pricing.						
12"	24"	36"	48"	60"	72"	Custom Len.
\$35.07	\$34.76	\$41.29	\$44.58	\$43.47	\$46.37	See Web

**RG316/U Coax, 50 Ohm**

Part No. <a href="#">PE3C3344</a>	Cable Dia.	Attn. @ 1 GHz	Power @ 1 GHz			
1 piece price shown. See web or call for volume pricing.						
12"	24"	36"	48"	60"	72"	Custom Len.
\$43.72	\$46.85	\$49.97	\$53.28	\$53.58	\$59.65	See Web

**RG400/U Coax, 50 Ohm**

Part No. <a href="#">PE3627</a>	Cable Dia.	Attn. @ 1 GHz	Power @ 1 GHz			
1 piece price shown. See web or call for volume pricing.						
12"	24"	36"	48"	60"	72"	Custom Len.
\$50.42	\$52.81	\$59.78	\$66.76	\$73.72	\$88.12	See Web

**RG55B/U Coax, 53 Ohm**

Part No. <a href="#">PE3375</a>	Cable Dia.	Attn. @ 1 GHz	Power @ 1 GHz			
1 piece price shown. See web or call for volume pricing.						
12"	24"	36"	48"	60"	72"	Custom Len.
\$33.28	\$35.51	\$37.76	\$40.00	\$42.24	\$44.48	See Web

**RG59B/U Coax, 75 Ohm**

Part No. <a href="#">PE3792</a>	Cable Dia.	Attn. @ 1 GHz	Power @ 1 GHz			
1 piece price shown. See web or call for volume pricing.						
12"	24"	36"	48"	60"	72"	Custom Len.
\$28.81	\$29.77	\$30.73	\$34.29	\$32.65	\$33.60	See Web

**RG62A/U Coax, 93 Ohm**

Part No. <a href="#">PE3368</a>	Cable Dia.	Attn. @ 1 GHz	Power @ 1 GHz			
1 piece price shown. See web or call for volume pricing.						
12"	24"	36"	48"	60"	72"	Custom Len.
\$27.09	\$28.41	\$29.74	\$31.05	\$32.38	\$33.69	See Web

**BNC MALE TO BNC FEMALE BULKHEAD**

SEE MOUNTING HOLE SECTION ON PAGE 369



**Low Loss Flexible Cable Assemblies**

**PE-C195 Coax, 50 Ohm**

Part No. <a href="#">PE38804</a>	Cable Dia.	Attn. @ 1 GHz	Power @ 1 GHz			
1 piece price shown. See web or call for volume pricing.						
12"	24"	36"	48"	60"	72"	Custom Len.
\$32.78	\$36.19	\$34.20	\$34.91	\$35.63	-	See Web

**Standard Flexible Cable Assemblies**

**RG8A/U Coax, 50 Ohm**

Part No. <a href="#">PE3440</a>	Cable Dia.	Attn. @ 1 GHz	Power @ 1 GHz			
1 piece price shown. See web or call for volume pricing.						
12"	24"	36"	48"	60"	72"	Custom Len.
\$93.88	\$96.65	\$99.40	\$102.10	\$104.87	\$107.57	See Web

**RG58C/U Coax, 50 Ohm**

Part No. <a href="#">PE3649</a>	Cable Dia.	Attn. @ 1 GHz	Power @ 1 GHz			
1 piece price shown. See web or call for volume pricing.						
12"	24"	36"	48"	60"	72"	Custom Len.
\$44.48	\$45.29	\$46.11	\$46.97	\$47.79	\$48.63	See Web

**RG142B/U Coax, 50 Ohm**

Part No. <a href="#">PE3436</a>	Cable Dia.	Attn. @ 1 GHz	Power @ 1 GHz			
1 piece price shown. See web or call for volume pricing.						
12"	24"	36"	48"	60"	72"	Custom Len.
\$50.01	\$51.19	\$56.92	\$62.66	\$68.39	\$74.12	See Web

**RG174A/U Coax, 50 Ohm**

Part No. <a href="#">PE3C3397</a>	Cable Dia.	Attn. @ 1 GHz	Power @ 1 GHz			
1 piece price shown. See web or call for volume pricing.						
12"	24"	36"	48"	60"	72"	Custom Len.
\$47.18	\$47.76	\$48.34	\$45.00	\$45.44	\$45.86	See Web

**RG223/U Coax, 50 Ohm**

Part No. <a href="#">PE3557</a>	Cable Dia.	Attn. @ 1 GHz	Power @ 1 GHz			
1 piece price shown. See web or call for volume pricing.						
12"	24"	36"	48"	60"	72"	Custom Len.
\$43.40	\$46.30	\$49.19	\$56.40	\$59.57	\$57.89	See Web

**RG316/U Coax, 50 Ohm**

Part No. <a href="#">PE3C3446</a>	Cable Dia.	Attn. @ 1 GHz	Power @ 1 GHz			
1 piece price shown. See web or call for volume pricing.						
12"	24"	36"	48"	60"	72"	Custom Len.
\$43.26	\$46.38	\$49.51	\$51.61	\$54.50	\$57.37	See Web

**RG400/U Coax, 50 Ohm**

Part No. <a href="#">PE3423</a>	Cable Dia.	Attn. @ 1 GHz	Power @ 1 GHz			
1 piece price shown. See web or call for volume pricing.						
12"	24"	36"	48"	60"	72"	Custom Len.
\$57.78	\$65.18	\$72.56	\$80.40	\$87.93	\$88.35	See Web

**RG59B/U Coax, 75 Ohm**

Part No. <a href="#">PE3103</a>	Cable Dia.	Attn. @ 1 GHz	Power @ 1 GHz			
1 piece price shown. See web or call for volume pricing.						
12"	24"	36"	48"	60"	72"	Custom Len.
\$41.55	\$42.51	\$43.46	\$44.43	\$45.39	\$50.99	See Web

\*Coax Performance at 1 GHz Notes: Cable assembly max frequency may be lower than connector or coax max frequency

For our complete selection of cable assemblies, please visit our website

BNC MALE TO MHV MALE						
Standard Flexible Cable Assemblies						
RG58C/U Coax, 50 Ohm						
Part No. <a href="#">PE3W00032</a>	Cable Dia.		Attn. @ 1 GHz	Power @ 1 GHz		
1 piece price shown. See web or call for volume pricing.						
12"	24"	36"	48"	60"	50CM	Custom Len.
\$44.30	\$45.95	\$46.82	\$47.68	\$48.54	\$45.64	See Web
BNC MALE TO N MALE						
Flexible Cable Assemblies						
LMR-240 Coax, 50 Ohm						
Part No. <a href="#">PE3W05881</a>	Cable Dia.		Attn. @ 1 GHz	Power @ 1 GHz		
1 piece price shown. See web or call for volume pricing.						
12"	24"	36"	48"	60"	50CM	Custom Len.
\$38.01	\$38.88	\$39.76	\$40.65	\$41.53	\$38.57	See Web
Standard Flexible Cable Assemblies						
RG142B/U Coax, 50 Ohm						
Part No. <a href="#">PE3061</a>	Cable Dia.		Attn. @ 1 GHz	Power @ 1 GHz		
1 piece price shown. See web or call for volume pricing.						
12"	24"	36"	48"	60"	72"	Custom Len.
\$44.54	\$50.62	\$56.70	\$63.13	\$64.17	\$69.90	See Web
Part No. <a href="#">PE3W06862</a>	Cable Dia.		Attn. @ 1 GHz	Power @ 1 GHz		
1 piece price shown. See web or call for volume pricing.						
12"	24"	36"	48"	60"	50CM	Custom Len.
\$39.43	\$45.32	\$51.22	\$57.12	\$63.03	\$43.20	See Web
BNC MALE TO SHV PLUG						
Standard Flexible Cable Assemblies						
RG58C/U Coax, 50 Ohm						
Part No. <a href="#">PE3W00148</a>	Cable Dia.		Attn. @ 1 GHz	Power @ 1 GHz		
1 piece price shown. See web or call for volume pricing.						
12"	24"	36"	48"	60"	50CM	Custom Len.
\$59.77	\$60.55	\$61.33	\$62.11	\$62.89	\$60.27	See Web
BNC MALE TO SMA MALE						
Standard Flexible Cable Assemblies						
RG188A/U Coax, 50 Ohm						
Part No. <a href="#">PE3W03670</a>	Cable Dia.		Attn. @ 1 GHz	Power @ 1 GHz		
1 piece price shown. See web or call for volume pricing.						
12"	24"	36"	48"	60"	50CM	Custom Len.
\$44.66	\$47.33	\$50.00	\$52.67	\$55.34	\$46.36	See Web
BNC MALE TO SSMC PLUG						
Low Loss Flexible Cable Assemblies						
LMR-100A-PVC Coax, 50 Ohm						
Part No. <a href="#">PE3C4430</a>	Cable Dia.		Attn. @ 1 GHz	Power @ 1 GHz		
1 piece price shown. See web or call for volume pricing.						
6"	12"	18"	24"	36"	48"	Custom Len.
\$45.98	\$42.13	\$42.50	\$47.11	\$43.61	\$48.67	See Web
Standard Formable Cable Assemblies						
PE-SR405FLJ Coax, 50 Ohm						
Part No. <a href="#">PE3C4450</a>	Cable Dia.		Attn. @ 1 GHz	Power @ 1 GHz		
1 piece price shown. See web or call for volume pricing.						
6"	12"	18"	24"	36"	48"	Custom Len.
\$70.43	\$81.61	\$77.97	\$81.73	\$89.25	\$96.77	See Web
Standard Flexible Cable Assemblies						
RG178B/U Coax, 50 Ohm						
Part No. <a href="#">PE3C4397</a>	Cable Dia.		Attn. @ 1 GHz	Power @ 1 GHz		
1 piece price shown. See web or call for volume pricing.						
6"	12"	18"	24"	36"	48"	Custom Len.
\$68.62	\$69.09	\$69.55	\$70.02	\$78.12	\$79.24	See Web
RG316/U Coax, 50 Ohm						
Part No. <a href="#">PE3C4413</a>	Cable Dia.		Attn. @ 1 GHz	Power @ 1 GHz		
1 piece price shown. See web or call for volume pricing.						
6"	12"	18"	24"	36"	48"	Custom Len.
\$52.34	\$53.75	\$55.15	\$56.54	\$63.22	\$62.15	See Web

BNC MALE TO SSMC PLUG RIGHT ANGLE						
Low Loss Flexible Cable Assemblies						
LMR-100A-PVC Coax, 50 Ohm						
Part No. <a href="#">PE3C4431</a>	Cable Dia.		Attn. @ 1 GHz	Power @ 1 GHz		
1 piece price shown. See web or call for volume pricing.						
6"	12"	18"	24"	36"	48"	Custom Len.
\$42.20	\$38.70	\$39.07	\$39.43	\$40.17	\$40.91	See Web
Standard Flexible Cable Assemblies						
RG178B/U Coax, 50 Ohm						
Part No. <a href="#">PE3C4466</a>	Cable Dia.		Attn. @ 1 GHz	Power @ 1 GHz		
1 piece price shown. See web or call for volume pricing.						
6"	12"	18"	24"	36"	48"	Custom Len.
\$60.20	\$60.68	\$61.15	\$61.60	\$62.54	\$63.47	See Web
RG316/U Coax, 50 Ohm						
Part No. <a href="#">PE3C4414</a>	Cable Dia.		Attn. @ 1 GHz	Power @ 1 GHz		
1 piece price shown. See web or call for volume pricing.						
6"	12"	18"	24"	36"	48"	Custom Len.
\$48.91	\$50.32	\$51.72	\$53.11	\$55.92	\$58.71	See Web
RG316-DS Coax, 50 Ohm						
Part No. <a href="#">PE3C4476</a>	Cable Dia.		Attn. @ 1 GHz	Power @ 1 GHz		
1 piece price shown. See web or call for volume pricing.						
6"	12"	18"	24"	36"	48"	Custom Len.
\$53.80	\$50.29	\$51.70	\$53.11	\$55.93	\$64.88	See Web
BNC MALE RIGHT ANGLE TO BNC MALE RIGHT ANGLE						
Standard Flexible Cable Assemblies						
RG58C/U Coax, 50 Ohm						
Part No. <a href="#">PE3025</a>	Cable Dia.		Attn. @ 1 GHz	Power @ 1 GHz		
1 piece price shown. See web or call for volume pricing.						
12"	24"	36"	48"	60"	72"	Custom Len.
\$70.27	\$71.08	\$71.90	\$72.76	\$73.58	\$74.41	See Web
RG142B/U Coax, 50 Ohm						
Part No. <a href="#">PE3044</a>	Cable Dia.		Attn. @ 1 GHz	Power @ 1 GHz		
1 piece price shown. See web or call for volume pricing.						
12"	24"	36"	48"	60"	72"	Custom Len.
\$71.96	\$78.04	\$79.35	\$85.08	\$90.82	\$96.54	See Web
RG174A/U Coax, 50 Ohm						
Part No. <a href="#">PE3373</a>	Cable Dia.		Attn. @ 1 GHz	Power @ 1 GHz		
1 piece price shown. See web or call for volume pricing.						
12"	24"	36"	48"	60"	72"	Custom Len.
\$83.33	\$77.60	\$78.03	\$78.47	\$78.90	\$79.33	See Web
RG188A/U Coax, 50 Ohm						
Part No. <a href="#">PE3351</a>	Cable Dia.		Attn. @ 1 GHz	Power @ 1 GHz		
1 piece price shown. See web or call for volume pricing.						
12"	24"	36"	48"	60"	72"	Custom Len.
\$78.98	\$81.20	\$83.42	\$85.64	\$87.86	\$98.01	See Web
RG188-DS Coax, 50 Ohm						
Part No. <a href="#">PE3381</a>	Cable Dia.		Attn. @ 1 GHz	Power @ 1 GHz		
1 piece price shown. See web or call for volume pricing.						
12"	24"	36"	48"	60"	72"	Custom Len.
\$74.27	\$77.56	\$80.87	\$84.16	\$87.40	\$90.70	See Web
RG213/U Coax, 50 Ohm						
Part No. <a href="#">PE3384</a>	Cable Dia.		Attn. @ 1 GHz	Power @ 1 GHz		
1 piece price shown. See web or call for volume pricing.						
12"	24"	36"	48"	60"	72"	Custom Len.
\$96.77	\$98.45	\$100.13	\$101.80	\$103.43	\$105.11	See Web
RG214/U Coax, 50 Ohm						
Part No. <a href="#">PE3370</a>	Cable Dia.		Attn. @ 1 GHz	Power @ 1 GHz		
1 piece price shown. See web or call for volume pricing.						
12"	24"	36"	48"	60"	72"	Custom Len.
\$102.47	\$109.85	\$117.23	\$124.63	\$131.99	\$139.38	See Web
RG223/U Coax, 50 Ohm						
Part No. <a href="#">PE3816</a>	Cable Dia.		Attn. @ 1 GHz	Power @ 1 GHz		
1 piece price shown. See web or call for volume pricing.						
12"	24"	36"	48"	60"	72"	Custom Len.
\$65.03	\$67.93	\$70.83	\$73.74	\$76.64	\$86.10	See Web
RG316/U Coax, 50 Ohm						
Part No. <a href="#">PE3842</a>	Cable Dia.		Attn. @ 1 GHz	Power @ 1 GHz		
1 piece price shown. See web or call for volume pricing.						
12"	24"	36"	48"	60"	72"	Custom Len.
\$86.27	\$89.40	\$85.67	\$88.54	\$91.43	\$94.32	See Web
RG316-DS Coax, 50 Ohm						
Part No. <a href="#">PE3389</a>	Cable Dia.		Attn. @ 1 GHz	Power @ 1 GHz		
1 piece price shown. See web or call for volume pricing.						
12"	24"	36"	48"	60"	72"	Custom Len.
\$76.14	\$79.27	\$82.38	\$79.23	\$88.88	\$85.04	See Web

Cable Assemblies

See Our Website For Current Pricing & Real-Time Stock Availability!

For Custom Lengths, Metric Lengths or Special Configurations, Please call (949) 261-1920



Technical Support  
+1 (949) 261-1920



Same-Day Shipping,  
Even Custom Cable Assemblies

For our complete selection of cable assemblies, please visit our website

Cable Assemblies

See Our Website For Current Pricing & Real-Time Stock Availability!

RG400/U Coax, 50 Ohm				
Part No. <a href="#">PE3458</a>	Cable Dia.	Attn. @ 1 GHz	Power @ 1 GHz	28
1 piece price shown. See web or call for volume pricing.	0.195" dia.	15 dB/100ft	650 W	
12" 24" 36" 48"	60"	72"	Custom Len.	
\$75.92 \$82.89 \$89.85 \$96.82	\$103.80	\$110.77	See Web	
PE-P195 Coax, 50 Ohm				
Part No. <a href="#">PE37640</a>	Cable Dia.	Attn. @ 1 GHz	Power @ 1 GHz	29
1 piece price shown. See web or call for volume pricing.	0.195" dia.	13 dB/100ft	160 W	
12" 24" 36" 48"	60"	-	Custom Len.	
\$67.35 \$76.19 \$85.04 \$93.90	\$102.76	-	See Web	
RG179B/U Coax, 75 Ohm				
Part No. <a href="#">PE3366</a>	Cable Dia.	Attn. @ 1 GHz	Power @ 1 GHz	30
1 piece price shown. See web or call for volume pricing.	0.100" dia.	25 dB/100ft	200 W	
12" 24" 36" 48"	60"	72"	Custom Len.	
\$73.36 \$75.75 \$78.09 \$80.51	\$82.85	\$85.24	See Web	
BNC MALE RIGHT ANGLE TO BNC FEMALE BULKHEAD SEE MOUNTING HOLE SECTION ON PAGE 369				
Standard Flexible Cable Assemblies				
RG58C/U Coax, 50 Ohm				
Part No. <a href="#">PE33189</a>	Cable Dia.	Attn. @ 1 GHz	Power @ 1 GHz	31
1 piece price shown. See web or call for volume pricing.	0.195" dia.	20 dB/100ft	44 W	
12" 24" 36" 48"	60"	-	Custom Len.	
\$62.70 \$63.51 \$64.33 \$62.51	\$66.02	-	See Web	
RG400/U Coax, 50 Ohm				
Part No. <a href="#">PE3C3314</a>	Cable Dia.	Attn. @ 1 GHz	Power @ 1 GHz	32
1 piece price shown. See web or call for volume pricing.	0.195" dia.	15 dB/100ft	650 W	
12" 24" 36" 48"	60"	50CM	Custom Len.	
\$68.39 \$75.56 \$82.74 \$89.92	\$97.09	\$72.98	See Web	
BNC MALE RIGHT ANGLE TO SMA FEMALE				
Standard Flexible Cable Assemblies				
RG316/U Coax, 50 Ohm				
Part No. <a href="#">PE3W04854</a>	Cable Dia.	Attn. @ 1 GHz	Power @ 1 GHz	33
1 piece price shown. See web or call for volume pricing.	0.098" dia.	58 dB/100ft	160 W	
12" 24" 36" 48"	60"	50CM	Custom Len.	
\$54.52 \$57.79 \$61.07 \$64.36	\$67.64	\$56.62	See Web	
BNC MALE RIGHT ANGLE TO TNC MALE RIGHT ANGLE				
Low Loss Flexible Cable Assemblies				
LMR-240-UF Coax, 50 Ohm				
Part No. <a href="#">PE3W07480</a>	Cable Dia.	Attn. @ 1 GHz	Power @ 1 GHz	34
1 piece price shown. See web or call for volume pricing.	0.240" dia.	9 dB/100ft	W	
12" 18" 24" 36"	48"	60"	Custom Len.	
\$65.75 \$66.40 \$67.05 \$68.35	\$69.65	\$70.95	See Web	
BNC FEMALE TO BNC MALE RIGHT ANGLE				
Standard Flexible Cable Assemblies				
RG174A/U Coax, 50 Ohm				
Part No. <a href="#">PE3W06649</a>	Cable Dia.	Attn. @ 1 GHz	Power @ 1 GHz	35
1 piece price shown. See web or call for volume pricing.	0.110" dia.	32 dB/100ft	17 W	
12" 24" 36" 48"	60"	50CM	Custom Len.	
\$84.73 \$85.29 \$85.85 \$86.41	\$86.97	\$85.08	See Web	
BNC FEMALE TO BNC FEMALE				
Standard Flexible Cable Assemblies				
RG58C/U Coax, 50 Ohm				
Part No. <a href="#">PE3052</a>	Cable Dia.	Attn. @ 1 GHz	Power @ 1 GHz	36
1 piece price shown. See web or call for volume pricing.	0.195" dia.	20 dB/100ft	44 W	
12" 24" 36" 48"	60"	72"	Custom Len.	
\$39.11 \$39.85 \$44.65 \$45.51	\$42.06	\$47.16	See Web	
RG142B/U Coax, 50 Ohm				
Part No. <a href="#">PE3088</a>	Cable Dia.	Attn. @ 1 GHz	Power @ 1 GHz	37
1 piece price shown. See web or call for volume pricing.	0.195" dia.	13 dB/100ft	W	
12" 24" 36" 48"	60"	72"	Custom Len.	
\$37.48 \$42.99 \$48.57 \$58.32	\$59.67	\$65.21	See Web	
RG174A/U Coax, 50 Ohm				
Part No. <a href="#">PE3604</a>	Cable Dia.	Attn. @ 1 GHz	Power @ 1 GHz	38
1 piece price shown. See web or call for volume pricing.	0.100" dia.	32 dB/100ft	16 W	
12" 24" 36" 48"	60"	72"	Custom Len.	
\$51.17 \$51.75 \$52.33 \$52.95	\$50.94	\$54.12	See Web	

RG178B/U Coax, 50 Ohm				
Part No. <a href="#">PE36455</a>	Cable Dia.	Attn. @ 1 GHz	Power @ 1 GHz	39
1 piece price shown. See web or call for volume pricing.	0.072" dia.	44 dB/100ft	78 W	
12" 24" 36" 48"	60"	-	Custom Len.	
\$73.39 \$68.93 \$75.51 \$76.64	\$71.81	-	See Web	
RG188A/U Coax, 50 Ohm				
Part No. <a href="#">PE3094</a>	Cable Dia.	Attn. @ 1 GHz	Power @ 1 GHz	40
1 piece price shown. See web or call for volume pricing.	0.110" dia.	26 dB/100ft	160 W	
12" 24" 36" 48"	60"	72"	Custom Len.	
\$52.00 \$59.69 \$56.44 \$58.66	\$60.89	\$63.10	See Web	
RG223/U Coax, 50 Ohm				
Part No. <a href="#">PE3364</a>	Cable Dia.	Attn. @ 1 GHz	Power @ 1 GHz	41
1 piece price shown. See web or call for volume pricing.	0.210" dia.	13 dB/100ft	53 W	
12" 24" 36" 48"	60"	72"	Custom Len.	
\$34.84 \$37.77 \$40.65 \$47.85	\$46.54	\$49.43	See Web	
RG316/U Coax, 50 Ohm				
Part No. <a href="#">PE3505</a>	Cable Dia.	Attn. @ 1 GHz	Power @ 1 GHz	42
1 piece price shown. See web or call for volume pricing.	0.098" dia.	38 dB/100ft	160 W	
12" 24" 36" 48"	60"	72"	Custom Len.	
\$52.91 \$55.79 \$63.39 \$66.69	\$64.47	\$67.35	See Web	
RG59B/U Coax, 75 Ohm				
Part No. <a href="#">PE3675</a>	Cable Dia.	Attn. @ 1 GHz	Power @ 1 GHz	43
1 piece price shown. See web or call for volume pricing.	0.242" dia.	12 dB/100ft	77 W	
12" 24" 36" 48"	60"	72"	Custom Len.	
\$23.07 \$23.94 \$24.80 \$25.67	\$26.53	\$27.40	See Web	
BNC FEMALE TO SMA MALE				
Standard Flexible Cable Assemblies				
RG174A/U Coax, 50 Ohm				
Part No. <a href="#">PE3W06305</a>	Cable Dia.	Attn. @ 1 GHz	Power @ 1 GHz	44
1 piece price shown. See web or call for volume pricing.	0.110" dia.	32 dB/100ft	17 W	
12" 18" 24" 36"	48"	60"	Custom Len.	
\$44.30 \$44.57 \$44.84 \$45.38	\$45.92	\$46.46	See Web	
BNC FEMALE BULKHEAD TO SMA MALE SEE MOUNTING HOLE SECTION ON PAGE 369				
Standard Formable Cable Assemblies				
PE-SR405FLJ Coax, 50 Ohm				
Part No. <a href="#">PE3W03377</a>	Cable Dia.	Attn. @ 1 GHz	Power @ 1 GHz	45
1 piece price shown. See web or call for volume pricing.	0.098" dia.	dB/100ft	122 W	
12" 24" 36" 48"	60"	50CM	Custom Len.	
\$76.08 \$85.02 \$93.98 \$102.93	\$111.89	\$81.81	See Web	
Standard Flexible Cable Assemblies				
RG58C/U Coax, 50 Ohm				
Part No. <a href="#">PE3W01634</a>	Cable Dia.	Attn. @ 1 GHz	Power @ 1 GHz	46
1 piece price shown. See web or call for volume pricing.	0.195" dia.	20 dB/100ft	80 W	
12" 24" 36" 48"	60"	50CM	Custom Len.	
\$33.62 \$34.48 \$35.35 \$36.21	\$37.07	\$34.17	See Web	
C MALE TO C MALE				
Standard Flexible Cable Assemblies				
RG8A/U Coax, 50 Ohm				
Part No. <a href="#">PE33316</a>	Cable Dia.	Attn. @ 1 GHz	Power @ 1 GHz	47
1 piece price shown. See web or call for volume pricing.	0.405" dia.	8 dB/100ft	190 W	
12" 24" 36" 48"	60"	72"	Custom Len.	
\$98.31 \$107.28 \$103.98 \$106.81	\$109.65	\$112.48	See Web	
RG58C/U Coax, 50 Ohm				
Part No. <a href="#">PE3457</a>	Cable Dia.	Attn. @ 1 GHz	Power @ 1 GHz	48
1 piece price shown. See web or call for volume pricing.	0.195" dia.	20 dB/100ft	44 W	
12" 24" 36" 48"	60"	72"	Custom Len.	
\$91.37 \$92.11 \$100.31 \$93.56	\$94.30	\$95.04	See Web	
RG142B/U Coax, 50 Ohm				
Part No. <a href="#">PE3518</a>	Cable Dia.	Attn. @ 1 GHz	Power @ 1 GHz	49
1 piece price shown. See web or call for volume pricing.	0.195" dia.	13 dB/100ft	650 W	
12" 24" 36" 48"	60"	72"	Custom Len.	
\$74.58 \$80.30 \$86.04 \$91.76	\$97.50	\$103.24	See Web	
RG213/U Coax, 50 Ohm				
Part No. <a href="#">PE3522</a>	Cable Dia.	Attn. @ 1 GHz	Power @ 1 GHz	50
1 piece price shown. See web or call for volume pricing.	0.405" dia.	8 dB/100ft	190 W	
12" 24" 36" 48"	60"	72"	Custom Len.	
\$97.16 \$98.83 \$100.48 \$102.15	\$103.81	\$105.48	See Web	
RG214/U Coax, 50 Ohm				
Part No. <a href="#">PE3605</a>	Cable Dia.	Attn. @ 1 GHz	Power @ 1 GHz	51
1 piece price shown. See web or call for volume pricing.	0.425" dia.	7 dB/100ft	190 W	
12" 24" 36" 48"	60"	72"	Custom Len.	
\$89.74 \$97.05 \$110.68 \$111.71	\$119.03	\$134.78	See Web	

\*Coax Performance at 1 GHz Notes: Cable assembly max frequency may be lower than connector or coax max frequency

For our complete selection of cable assemblies, please visit our website

RG217/U Coax, 50 Ohm					Cable Dia.	Attn. @ 1 GHz	Power @ 1 GHz
1 piece price shown. See web or call for volume pricing.					0.545" dia.	6 dB/100ft	260 W
12"	24"	36"	48"	60"	72"	Custom Len.	
\$152.71	\$157.12	\$161.52	\$165.92	\$181.12	\$174.73	See Web	

RG223/U Coax, 50 Ohm					Cable Dia.	Attn. @ 1 GHz	Power @ 1 GHz
1 piece price shown. See web or call for volume pricing.					0.210" dia.	13 dB/100ft	53 W
12"	24"	36"	48"	60"	72"	Custom Len.	
\$71.72	\$74.62	\$77.52	\$80.42	\$83.32	\$86.22	See Web	

RG225/U Coax, 50 Ohm					Cable Dia.	Attn. @ 1 GHz	Power @ 1 GHz
1 piece price shown. See web or call for volume pricing.					0.430" dia.	8 dB/100ft	1700 W
12"	24"	36"	48"	60"	72"	Custom Len.	
\$109.85	\$142.44	\$175.02	\$207.61	\$240.21	\$272.80	See Web	

RG393/U Coax, 50 Ohm					Cable Dia.	Attn. @ 1 GHz	Power @ 1 GHz
1 piece price shown. See web or call for volume pricing.					0.390" dia.	8 dB/100ft	1700 W
12"	24"	36"	48"	60"	72"	Custom Len.	
\$98.43	\$120.74	\$137.15	\$144.84	\$171.24	\$187.97	See Web	

**C MALE RIGHT ANGLE TO C MALE**



**Standard Flexible Cable Assemblies**

RG214/U Coax, 50 Ohm					Cable Dia.	Attn. @ 1 GHz	Power @ 1 GHz
1 piece price shown. See web or call for volume pricing.					0.425" dia.	7 dB/100ft	170 W
12"	18"	24"	36"	48"	60"	Custom Len.	
\$144.35	\$148.20	\$152.06	\$159.77	\$167.48	\$175.19	See Web	

**FAKRA PLUG TO FAKRA PLUG**



**Low Loss Flexible Cable Assemblies**

PE-C100-LSZH Coax, 50 Ohm					Cable Dia.	Attn. @ 1 GHz	Power @ 1 GHz
1 piece price shown. See web or call for volume pricing.					0.109" dia.	25 dB/100ft	W
12"	24"	36"	48"	60"	-	Custom Len.	
\$21.86	\$24.45	\$25.72	\$27.63	\$29.60	-	See Web	

PE-C100-LSZH Coax, 50 Ohm					Cable Dia.	Attn. @ 1 GHz	Power @ 1 GHz
1 piece price shown. See web or call for volume pricing.					0.109" dia.	25 dB/100ft	W
12"	24"	36"	48"	60"	-	Custom Len.	
\$26.97	\$26.18	\$27.40	\$31.03	\$32.39	-	See Web	

**Standard Flexible Cable Assemblies**

RG174A/U Coax, 50 Ohm					Cable Dia.	Attn. @ 1 GHz	Power @ 1 GHz
1 piece price shown. See web or call for volume pricing.					0.100" dia.	32 dB/100ft	16 W
12"	24"	36"	48"	60"	-	Custom Len.	
\$29.28	\$27.16	\$27.68	\$28.18	\$28.71	-	See Web	

RG174A/U Coax, 50 Ohm					Cable Dia.	Attn. @ 1 GHz	Power @ 1 GHz
1 piece price shown. See web or call for volume pricing.					0.100" dia.	32 dB/100ft	16 W
12"	24"	36"	48"	60"	-	Custom Len.	
\$32.21	\$29.72	\$30.15	\$30.59	\$34.57	-	See Web	

**Standard Flexible Cable Assemblies**

RG316/U Coax, 50 Ohm					Cable Dia.	Attn. @ 1 GHz	Power @ 1 GHz
1 piece price shown. See web or call for volume pricing.					0.098" dia.	38 dB/100ft	160 W
12"	24"	36"	48"	60"	-	Custom Len.	
\$30.71	\$30.64	\$33.41	\$36.18	\$38.95	-	See Web	

PE-C100-LSZH Coax, 50 Ohm					Cable Dia.	Attn. @ 1 GHz	Power @ 1 GHz
1 piece price shown. See web or call for volume pricing.					0.098" dia.	38 dB/100ft	160 W
12"	24"	36"	48"	60"	-	Custom Len.	
\$29.01	\$31.83	\$34.71	\$41.47	\$40.47	-	See Web	

**FAKRA PLUG TO FAKRA JACK**



**Low Loss Flexible Cable Assemblies**

PE-C100-LSZH Coax, 50 Ohm					Cable Dia.	Attn. @ 1 GHz	Power @ 1 GHz
1 piece price shown. See web or call for volume pricing.					0.109" dia.	25 dB/100ft	W
12"	24"	36"	48"	60"	-	Custom Len.	
\$24.98	\$26.18	\$27.40	\$28.71	\$32.88	-	See Web	

PE-C100-LSZH Coax, 50 Ohm					Cable Dia.	Attn. @ 1 GHz	Power @ 1 GHz
1 piece price shown. See web or call for volume pricing.					0.109" dia.	25 dB/100ft	W
12"	24"	36"	48"	60"	-	Custom Len.	
\$27.47	\$26.18	\$30.13	\$28.71	\$32.88	-	See Web	

PE-C100-LSZH Coax, 50 Ohm					Cable Dia.	Attn. @ 1 GHz	Power @ 1 GHz
1 piece price shown. See web or call for volume pricing.					0.109" dia.	25 dB/100ft	W
12"	24"	36"	48"	60"	-	Custom Len.	
\$24.98	\$26.18	\$27.40	\$28.71	\$30.75	-	See Web	

RG316/U Coax, 50 Ohm					Cable Dia.	Attn. @ 1 GHz	Power @ 1 GHz
1 piece price shown. See web or call for volume pricing.					0.109" dia.	25 dB/100ft	W
12"	24"	36"	48"	60"	-	Custom Len.	
\$24.98	\$26.18	\$29.63	\$28.71	\$32.39	-	See Web	

RG316/U Coax, 50 Ohm					Cable Dia.	Attn. @ 1 GHz	Power @ 1 GHz
1 piece price shown. See web or call for volume pricing.					0.109" dia.	25 dB/100ft	W
12"	24"	36"	48"	60"	-	Custom Len.	
\$26.49	\$27.82	\$29.14	\$30.56	\$31.91	-	See Web	

**Standard Flexible Cable Assemblies**

RG174A/U Coax, 50 Ohm					Cable Dia.	Attn. @ 1 GHz	Power @ 1 GHz
1 piece price shown. See web or call for volume pricing.					0.100" dia.	32 dB/100ft	16 W
12"	24"	36"	48"	60"	-	Custom Len.	
\$29.28	\$29.72	\$30.15	\$30.59	\$31.02	-	See Web	

PE-C100-LSZH Coax, 50 Ohm					Cable Dia.	Attn. @ 1 GHz	Power @ 1 GHz
1 piece price shown. See web or call for volume pricing.					0.100" dia.	32 dB/100ft	16 W
12"	24"	36"	48"	60"	-	Custom Len.	
\$29.28	\$29.72	\$30.15	\$30.59	\$34.57	-	See Web	

RG174A/U Coax, 50 Ohm					Cable Dia.	Attn. @ 1 GHz	Power @ 1 GHz
1 piece price shown. See web or call for volume pricing.					0.100" dia.	32 dB/100ft	16 W
12"	24"	36"	48"	60"	-	Custom Len.	
\$29.28	\$29.72	\$30.15	\$30.59	\$33.98	-	See Web	

RG174A/U Coax, 50 Ohm					Cable Dia.	Attn. @ 1 GHz	Power @ 1 GHz
1 piece price shown. See web or call for volume pricing.					0.100" dia.	32 dB/100ft	16 W
12"	24"	36"	48"	60"	-	Custom Len.	
\$29.28	\$29.72	\$30.15	\$30.59	\$34.57	-	See Web	

PE-C100-LSZH Coax, 50 Ohm					Cable Dia.	Attn. @ 1 GHz	Power @ 1 GHz
1 piece price shown. See web or call for volume pricing.					0.100" dia.	32 dB/100ft	16 W
12"	24"	36"	48"	60"	-	Custom Len.	
\$28.75	\$31.63	\$29.61	\$32.81	\$30.49	-	See Web	

PE-C100-LSZH Coax, 50 Ohm					Cable Dia.	Attn. @ 1 GHz	Power @ 1 GHz
1 piece price shown. See web or call for volume pricing.					0.100" dia.	32 dB/100ft	16 W
12"	24"	36"	48"	60"	-	Custom Len.	
\$31.05	\$31.63	\$32.21	\$32.81	\$33.40	-	See Web	

RG316/U Coax, 50 Ohm					Cable Dia.	Attn. @ 1 GHz	Power @ 1 GHz
1 piece price shown. See web or call for volume pricing.					0.098" dia.	38 dB/100ft	160 W
12"	24"	36"	48"	60"	-	Custom Len.	
\$31.91	\$34.80	\$37.69	\$40.58	\$43.47	-	See Web	

PE-C100-LSZH Coax, 50 Ohm					Cable Dia.	Attn. @ 1 GHz	Power @ 1 GHz
1 piece price shown. See web or call for volume pricing.					0.098" dia.	38 dB/100ft	160 W
12"	24"	36"	48"	60"	-	Custom Len.	
\$29.01	\$31.83	\$34.71	\$37.59	\$44.66	-	See Web	

PE-C100-LSZH Coax, 50 Ohm					Cable Dia.	Attn. @ 1 GHz	Power @ 1 GHz
1 piece price shown. See web or call for volume pricing.					0.098" dia.	38 dB/100ft	160 W
12"	24"	36"	48"	60"	-	Custom Len.	
\$31.91	\$34.80	\$37.69	\$40.58	\$43.47	-	See Web	

PE-C100-LSZH Coax, 50 Ohm					Cable Dia.	Attn. @ 1 GHz	Power @ 1 GHz
1 piece price shown. See web or call for volume pricing.					0.098" dia.	38 dB/100ft	160 W
12"	24"	36"	48"	60"	-	Custom Len.	
\$35.10	\$38.22	\$41.35	\$40.58	\$47.85	-	See Web	

**FAKRA PLUG TO FAKRA JACK RIGHT ANGLE**



**Low Loss Flexible Cable Assemblies**

PE-C100-LSZH Coax, 50 Ohm					Cable Dia.	Attn. @ 1 GHz	Power @ 1 GHz
1 piece price shown. See web or call for volume pricing.					0.109" dia.	25 dB/100ft	W
12"	24"	36"	48"	60"	-	Custom Len.	
\$24.17	\$22.61	\$23.29	\$23.94	\$24.63	-	See Web	

PE-C100-LSZH Coax, 50 Ohm					Cable Dia.	Attn. @ 1 GHz	Power @ 1 GHz
1 piece price shown. See web or call for volume pricing.					0.109" dia.	25 dB/100ft	W
12"	24"	36"	48"	60"	-	Custom Len.	
\$23.97	\$25.94	\$27.98	\$30.42	\$32.01	-	See Web	

PE-C100-LSZH Coax, 50 Ohm					Cable Dia.	Attn. @ 1 GHz	Power @ 1 GHz
1 piece price shown. See web or call for volume pricing.					0.109" dia.	25 dB/100ft	W
12"	24"	36"	48"	60"	-	Custom Len.	
\$21.97	\$22.61	\$23.29	\$23.94	\$24.63	-	See Web	

PE-C100-LSZH Coax, 50 Ohm					Cable Dia.	Attn. @ 1 GHz	Power @ 1 GHz
1 piece price shown. See web or call for volume pricing.					0.109" dia.	25 dB/100ft	W
12"	24"	36"	48"	60"	-	Custom Len.	
\$21.97	\$22.61	\$23.29	\$23.94	\$24.63	-	See Web	

PE-C100-LSZH Coax, 50 Ohm					Cable Dia.	Attn. @ 1 GHz	Power @ 1 GHz
1 piece price shown. See web or call for volume pricing.					0.109" dia.	25 dB/100ft	W
12"	24"	36"	48"	60"	-	Custom Len.	
\$26.38	\$27.58	\$28.78	\$30.00	\$32.01	-	See Web	

**Standard Flexible Cable Assemblies**

Cable Assemblies

See Our Website For Current Pricing & Real-Time Stock Availability!

Continued on Next Page

For Custom Lengths, Metric Lengths or Special Configurations, Please call (949) 261-1920



Technical Support  
+1 (949) 261-1920



Same-Day Shipping,  
Even Custom Cable Assemblies

For our complete selection of cable assemblies, please visit our website

Cable Assemblies  
See Our Website For Current Pricing & Real-Time Stock Availability!

RG174A/U Coax, 50 Ohm				
Part No. <a href="#">PE38753C</a>	Cable Dia.	Attn. @ 1 GHz	Power @ 1 GHz	
1 piece price shown. See web or call for volume pricing.				
12"	24"	36"	48"	60"
\$35.88	\$36.30	\$36.74	\$37.18	\$41.10
				See Web
Part No. <a href="#">PE38753H</a>	Cable Dia.	Attn. @ 1 GHz	Power @ 1 GHz	
1 piece price shown. See web or call for volume pricing.				
12"	24"	36"	48"	60"
\$36.53	\$36.97	\$37.41	\$37.84	\$38.28
				See Web
Part No. <a href="#">PE38753Z</a>	Cable Dia.	Attn. @ 1 GHz	Power @ 1 GHz	
1 piece price shown. See web or call for volume pricing.				
12"	24"	36"	48"	60"
\$39.45	\$40.03	\$37.41	\$37.84	\$38.28
				See Web
FAKRA JACK TO FAKRA JACK				
Flexible Cable Assemblies				
PE-C100-LSZH Coax, 50 Ohm				
Part No. <a href="#">PE38746A</a>	Cable Dia.	Attn. @ 1 GHz	Power @ 1 GHz	
1 piece price shown. See web or call for volume pricing.				
12"	24"	36"	48"	60"
\$27.47	\$28.80	\$27.40	\$28.71	\$30.75
				See Web
Part No. <a href="#">PE38746Z</a>	Cable Dia.	Attn. @ 1 GHz	Power @ 1 GHz	
1 piece price shown. See web or call for volume pricing.				
12"	24"	36"	48"	60"
\$23.64	\$24.96	\$26.29	\$27.69	\$29.05
				See Web
Low Loss Flexible Cable Assemblies				
PE-C100-LSZH Coax, 50 Ohm				
Part No. <a href="#">PE38746B</a>	Cable Dia.	Attn. @ 1 GHz	Power @ 1 GHz	
1 piece price shown. See web or call for volume pricing.				
12"	24"	36"	48"	60"
\$26.97	\$28.30	\$27.40	\$28.71	\$32.39
				See Web
Part No. <a href="#">PE38746C</a>	Cable Dia.	Attn. @ 1 GHz	Power @ 1 GHz	
1 piece price shown. See web or call for volume pricing.				
12"	24"	36"	48"	60"
\$27.47	\$28.80	\$27.40	\$31.53	\$32.88
				See Web
Part No. <a href="#">PE38746D</a>	Cable Dia.	Attn. @ 1 GHz	Power @ 1 GHz	
1 piece price shown. See web or call for volume pricing.				
12"	24"	36"	48"	60"
\$24.98	\$26.18	\$29.63	\$31.03	\$30.75
				See Web
Part No. <a href="#">PE38746H</a>	Cable Dia.	Attn. @ 1 GHz	Power @ 1 GHz	
1 piece price shown. See web or call for volume pricing.				
12"	24"	36"	48"	60"
\$21.51	\$22.23	\$22.94	\$23.61	\$24.32
				See Web
Part No. <a href="#">PE38746I</a>	Cable Dia.	Attn. @ 1 GHz	Power @ 1 GHz	
1 piece price shown. See web or call for volume pricing.				
12"	24"	36"	48"	60"
\$24.98	\$26.18	\$30.13	\$28.71	\$32.88
				See Web
Part No. <a href="#">PE38746K</a>	Cable Dia.	Attn. @ 1 GHz	Power @ 1 GHz	
1 piece price shown. See web or call for volume pricing.				
12"	24"	36"	48"	60"
\$24.98	\$26.18	\$27.40	\$31.53	\$30.75
				See Web
Standard Flexible Cable Assemblies				
RG174A/U Coax, 50 Ohm				
Part No. <a href="#">PE38750A</a>	Cable Dia.	Attn. @ 1 GHz	Power @ 1 GHz	
1 piece price shown. See web or call for volume pricing.				
12"	24"	36"	48"	60"
\$29.28	\$29.72	\$33.36	\$30.59	\$31.02
				See Web
Part No. <a href="#">PE38750B</a>	Cable Dia.	Attn. @ 1 GHz	Power @ 1 GHz	
1 piece price shown. See web or call for volume pricing.				
12"	24"	36"	48"	60"
\$26.62	\$27.16	\$29.90	\$28.18	\$28.71
				See Web
Part No. <a href="#">PE38750C</a>	Cable Dia.	Attn. @ 1 GHz	Power @ 1 GHz	
1 piece price shown. See web or call for volume pricing.				
12"	24"	36"	48"	60"
\$29.28	\$29.72	\$32.19	\$30.59	\$33.39
				See Web
Part No. <a href="#">PE38750D</a>	Cable Dia.	Attn. @ 1 GHz	Power @ 1 GHz	
1 piece price shown. See web or call for volume pricing.				
12"	24"	36"	48"	60"
\$29.28	\$29.72	\$32.78	\$30.59	\$33.98
				See Web
Part No. <a href="#">PE38750H</a>	Cable Dia.	Attn. @ 1 GHz	Power @ 1 GHz	
1 piece price shown. See web or call for volume pricing.				
12"	24"	36"	48"	60"
\$28.75	\$31.63	\$29.61	\$32.81	\$30.49
				See Web
Part No. <a href="#">PE38750I</a>	Cable Dia.	Attn. @ 1 GHz	Power @ 1 GHz	
1 piece price shown. See web or call for volume pricing.				
12"	24"	36"	48"	60"
\$26.62	\$27.16	\$27.68	\$28.18	\$28.71
				See Web
Part No. <a href="#">PE38750K</a>	Cable Dia.	Attn. @ 1 GHz	Power @ 1 GHz	
1 piece price shown. See web or call for volume pricing.				
12"	24"	36"	48"	60"
\$29.28	\$32.20	\$30.15	\$30.59	\$31.02
				See Web

Part No. <a href="#">PE38750Z</a>	Cable Dia.	Attn. @ 1 GHz	Power @ 1 GHz	
1 piece price shown. See web or call for volume pricing.				
12"	24"	36"	48"	60"
\$29.35	\$29.92	\$30.51	\$31.12	\$31.70
				See Web
RG188-DS Coax, 50 Ohm				
Part No. <a href="#">PE3W02209</a>	Cable Dia.	Attn. @ 1 GHz	Power @ 1 GHz	
1 piece price shown. See web or call for volume pricing.				
12"	24"	36"	48"	60"
\$30.47	\$33.89	\$37.31	\$40.73	\$44.15
				See Web
RG316/U Coax, 50 Ohm				
Part No. <a href="#">PE38754C</a>	Cable Dia.	Attn. @ 1 GHz	Power @ 1 GHz	
1 piece price shown. See web or call for volume pricing.				
12"	24"	36"	48"	60"
\$30.75	\$33.87	\$37.00	\$37.59	\$40.47
				See Web
Part No. <a href="#">PE38754D</a>	Cable Dia.	Attn. @ 1 GHz	Power @ 1 GHz	
1 piece price shown. See web or call for volume pricing.				
12"	24"	36"	48"	60"
\$31.91	\$35.04	\$34.71	\$37.59	\$40.47
				See Web
Part No. <a href="#">PE38754H</a>	Cable Dia.	Attn. @ 1 GHz	Power @ 1 GHz	
1 piece price shown. See web or call for volume pricing.				
12"	24"	36"	48"	60"
\$29.01	\$31.83	\$37.00	\$37.59	\$40.47
				See Web
Part No. <a href="#">PE38754Z</a>	Cable Dia.	Attn. @ 1 GHz	Power @ 1 GHz	
1 piece price shown. See web or call for volume pricing.				
12"	24"	36"	48"	60"
\$32.27	\$35.40	\$38.53	\$41.83	\$45.02
				See Web
FAKRA JACK TO FAKRA JACK RIGHT ANGLE				
Low Loss Flexible Cable Assemblies				
LMR-100A-PVC Coax, 50 Ohm				
Part No. <a href="#">PE3W02943</a>	Cable Dia.	Attn. @ 1 GHz	Power @ 1 GHz	
1 piece price shown. See web or call for volume pricing.				
12"	24"	36"	48"	60"
\$23.77	\$24.51	\$25.24	\$25.98	\$26.71
				See Web
FAKRA JACK TO SMA FEMALE				
Standard Flexible Cable Assemblies				
RG316/U Coax, 50 Ohm				
Part No. <a href="#">PE39351Z</a>	Cable Dia.	Attn. @ 1 GHz	Power @ 1 GHz	
1 piece price shown. See web or call for volume pricing.				
12"	24"	36"	48"	60"
\$56.60	\$54.34	\$57.24	\$60.13	\$63.02
				See Web
FAKRA JACK TO REVERSE POLARITY TNC MALE				
Low Loss Flexible Cable Assemblies				
LMR-100A-PVC Coax, 50 Ohm				
Part No. <a href="#">PE3W03361</a>	Cable Dia.	Attn. @ 1 GHz	Power @ 1 GHz	
1 piece price shown. See web or call for volume pricing.				
12"	24"	36"	48"	60"
\$40.35	\$41.07	\$41.80	\$42.53	\$43.25
				See Web
FAKRA JACK RIGHT ANGLE TO FAKRA PLUG				
Standard Flexible Cable Assemblies				
RG316/U Coax, 50 Ohm				
Part No. <a href="#">PE38757Z</a>	Cable Dia.	Attn. @ 1 GHz	Power @ 1 GHz	
1 piece price shown. See web or call for volume pricing.				
12"	24"	36"	48"	60"
\$43.01	\$42.00	\$44.88	\$47.77	\$50.66
				See Web
FME PLUG TO BNC MALE				
Standard Flexible Cable Assemblies				
RG174A/U Coax, 50 Ohm				
Part No. <a href="#">PE3C3420</a>	Cable Dia.	Attn. @ 1 GHz	Power @ 1 GHz	
1 piece price shown. See web or call for volume pricing.				
12"	24"	36"	48"	60"
\$36.34	\$36.76	\$37.22	\$37.61	\$38.03
				See Web
FME PLUG BULKHEAD TO UMCX PLUG RIGHT ANGLE				
SEE MOUNTING HOLE SECTION ON PAGE 369				
Standard Flexible Cable Assemblies				

\*Coax Performance at 1 GHz Notes: Cable assembly max frequency may be lower than connector or coax max frequency



For our complete selection of cable assemblies, please visit our website

PE-113mm Coax, 50 Ohm							
Part No. <a href="#">PE38858</a>	Cable Dia.			Attn. @ 1 GHz	Power @ 1 GHz		
1 piece price shown. See web or call for volume pricing.	0.044" dia.			dB/100ft	W		
6"	12"	18"	-	-	-	Custom Len.	14
\$31.03	\$14.02	\$30.02	-	-	-	See Web	

**FME JACK TO BNC MALE**



**Standard Flexible Cable Assemblies**

RG58C/U Coax, 50 Ohm							
Part No. <a href="#">PE34862</a>	Cable Dia.			Attn. @ 1 GHz	Power @ 1 GHz		
1 piece price shown. See web or call for volume pricing.	0.195" dia.			20 dB/100ft	44 W		
12"	24"	36"	48"	60"	72"	Custom Len.	15
\$33.09	\$33.82	\$34.59	\$35.31	\$36.02	\$36.76	See Web	

**FME JACK TO FME JACK**



**Standard Flexible Cable Assemblies**

RG58C/U Coax, 50 Ohm							
Part No. <a href="#">PE34856</a>	Cable Dia.			Attn. @ 1 GHz	Power @ 1 GHz		
1 piece price shown. See web or call for volume pricing.	0.195" dia.			20 dB/100ft	44 W		
12"	24"	36"	48"	60"	72"	Custom Len.	16
\$37.80	\$38.54	\$39.27	\$40.01	\$40.75	\$41.48	See Web	

RG174A/U Coax, 50 Ohm							
Part No. <a href="#">PE34860</a>	Cable Dia.			Attn. @ 1 GHz	Power @ 1 GHz		
1 piece price shown. See web or call for volume pricing.	0.100" dia.			32 dB/100ft	16 W		
12"	24"	36"	48"	60"	72"	Custom Len.	17
\$44.32	\$40.71	\$41.20	\$41.62	\$42.09	\$42.51	See Web	

**GR874 SEXLESS TO BNC MALE**



**Standard Flexible Cable Assemblies**

RG214/U Coax, 50 Ohm							
Part No. <a href="#">PE3145</a>	Cable Dia.			Attn. @ 1 GHz	Power @ 1 GHz		
1 piece price shown. See web or call for volume pricing.	0.425" dia.			7 dB/100ft	170 W		
12"	24"	36"	48"	60"	72"	Custom Len.	18
\$138.78	\$146.16	\$153.54	\$160.93	\$168.30	\$175.69	See Web	

RG223/U Coax, 50 Ohm							
Part No. <a href="#">PE3182</a>	Cable Dia.			Attn. @ 1 GHz	Power @ 1 GHz		
1 piece price shown. See web or call for volume pricing.	0.209" dia.			13 dB/100ft	50 W		
12"	24"	36"	48"	60"	72"	Custom Len.	19
\$49.29	\$52.24	\$55.12	\$58.07	\$60.99	\$63.88	See Web	

**GR874 SEXLESS TO GR874 SEXLESS**



**Standard Flexible Cable Assemblies**

RG58C/U Coax, 50 Ohm							
Part No. <a href="#">PE3211</a>	Cable Dia.			Attn. @ 1 GHz	Power @ 1 GHz		
1 piece price shown. See web or call for volume pricing.	0.195" dia.			20 dB/100ft	44 W		
12"	24"	36"	48"	60"	72"	Custom Len.	20
\$74.15	\$74.87	\$75.59	\$76.29	\$77.01	\$77.79	See Web	

RG223/U Coax, 50 Ohm							
Part No. <a href="#">PE3190</a>	Cable Dia.			Attn. @ 1 GHz	Power @ 1 GHz		
1 piece price shown. See web or call for volume pricing.	0.209" dia.			13 dB/100ft	50 W		
12"	24"	36"	48"	60"	72"	Custom Len.	21
\$74.52	\$77.42	\$80.31	\$83.20	\$86.11	\$89.01	See Web	

**HN MALE TO 7/16 DIN MALE RIGHT ANGLE**



**Standard Flexible Cable Assemblies**

RG217/U Coax, 50 Ohm							
Part No. <a href="#">PE3W03391</a>	Cable Dia.			Attn. @ 1 GHz	Power @ 1 GHz		
1 piece price shown. See web or call for volume pricing.	0.545" dia.			6 dB/100ft	260 W		
12"	24"	36"	48"	60"	50CM	Custom Len.	22
\$259.73	\$264.62	\$269.53	\$274.43	\$279.34	\$262.87	See Web	

**HN MALE TO HN MALE**



**Standard Flexible Cable Assemblies**

RG8A/U Coax, 50 Ohm							
Part No. <a href="#">PE33304</a>	Cable Dia.			Attn. @ 1 GHz	Power @ 1 GHz		
1 piece price shown. See web or call for volume pricing.	0.405" dia.			8 dB/100ft	190 W		
12"	24"	36"	48"	60"	72"	Custom Len.	23
\$111.68	\$114.52	\$124.52	\$127.78	\$123.02	\$125.84	See Web	

RG58C/U Coax, 50 Ohm							
----------------------	--	--	--	--	--	--	--

Part No. <a href="#">PE3852</a>	Cable Dia.			Attn. @ 1 GHz	Power @ 1 GHz		
1 piece price shown. See web or call for volume pricing.	0.195" dia.			20 dB/100ft	44 W		
12"	24"	36"	48"	60"	72"	Custom Len.	24
\$87.11	\$87.85	\$88.59	\$89.32	\$90.06	\$90.80	See Web	

RG141A/U Coax, 50 Ohm							
Part No. <a href="#">PE34434</a>	Cable Dia.			Attn. @ 1 GHz	Power @ 1 GHz		
1 piece price shown. See web or call for volume pricing.	0.190" dia.			13 dB/100ft	650 W		
12"	24"	36"	48"	60"	72"	Custom Len.	25
\$93.71	\$100.00	\$106.25	\$112.48	\$118.74	\$124.98	See Web	

RG142B/U Coax, 50 Ohm							
Part No. <a href="#">PE3083</a>	Cable Dia.			Attn. @ 1 GHz	Power @ 1 GHz		
1 piece price shown. See web or call for volume pricing.	0.195" dia.			13 dB/100ft	W		
12"	24"	36"	48"	60"	72"	Custom Len.	26
\$90.62	\$96.36	\$108.21	\$114.65	\$113.55	\$127.04	See Web	

RG213/U Coax, 50 Ohm							
Part No. <a href="#">PE3038</a>	Cable Dia.			Attn. @ 1 GHz	Power @ 1 GHz		
1 piece price shown. See web or call for volume pricing.	0.405" dia.			9 dB/100ft	190 W		
12"	24"	36"	48"	60"	72"	Custom Len.	27
\$117.15	\$118.93	\$120.72	\$122.61	\$124.44	\$126.26	See Web	

RG214/U Coax, 50 Ohm							
Part No. <a href="#">PE3095</a>	Cable Dia.			Attn. @ 1 GHz	Power @ 1 GHz		
1 piece price shown. See web or call for volume pricing.	0.425" dia.			7 dB/100ft	170 W		
12"	24"	36"	48"	60"	72"	Custom Len.	28
\$125.93	\$126.12	\$133.45	\$149.72	\$157.65	\$165.59	See Web	

RG217/U Coax, 50 Ohm							
Part No. <a href="#">PE33370</a>	Cable Dia.			Attn. @ 1 GHz	Power @ 1 GHz		
1 piece price shown. See web or call for volume pricing.	0.545" dia.			6 dB/100ft	260 W		
12"	24"	36"	48"	60"	72"	Custom Len.	29
\$126.03	\$130.75	\$135.46	\$140.46	\$145.27	\$150.08	See Web	

RG218/U Coax, 50 Ohm							
Part No. <a href="#">PE33583</a>	Cable Dia.			Attn. @ 1 GHz	Power @ 1 GHz		
1 piece price shown. See web or call for volume pricing.	0.870" dia.			4 dB/100ft	560 W		
12"	24"	36"	48"	60"	72"	Custom Len.	30
\$279.52	\$290.67	\$301.84	\$312.95	\$324.11	\$335.27	See Web	

RG223/U Coax, 50 Ohm							
Part No. <a href="#">PE3357</a>	Cable Dia.			Attn. @ 1 GHz	Power @ 1 GHz		
1 piece price shown. See web or call for volume pricing.	0.210" dia.			13 dB/100ft	53 W		
12"	24"	36"	48"	60"	72"	Custom Len.	31
\$87.83	\$96.21	\$99.33	\$96.52	\$105.79	\$102.32	See Web	

RG225/U Coax, 50 Ohm							
Part No. <a href="#">PE33778</a>	Cable Dia.			Attn. @ 1 GHz	Power @ 1 GHz		
1 piece price shown. See web or call for volume pricing.	0.430" dia.			dB/100ft	1700 W		
12"	24"	36"	48"	60"	72"	Custom Len.	32
\$145.51	\$179.11	\$212.71	\$246.31	\$279.91	\$313.51	See Web	

RG393/U Coax, 50 Ohm							
Part No. <a href="#">PE3340</a>	Cable Dia.			Attn. @ 1 GHz	Power @ 1 GHz		
1 piece price shown. See web or call for volume pricing.	0.390" dia.			8 dB/100ft	1700 W		
12"	24"	36"	48"	60"	72"	Custom Len.	33
\$130.29	\$138.38	\$163.10	\$180.46	\$197.18	\$213.91	See Web	

RG400/U Coax, 50 Ohm							
Part No. <a href="#">PE33938</a>	Cable Dia.			Attn. @ 1 GHz	Power @ 1 GHz		
1 piece price shown. See web or call for volume pricing.	0.195" dia.			15 dB/100ft	650 W		
12"	24"	36"	48"	60"	72"	Custom Len.	34
\$104.42	\$105.48	\$112.45	\$119.42	\$126.39	\$133.36	See Web	

RG59B/U Coax, 75 Ohm							
Part No. <a href="#">PE34436</a>	Cable Dia.			Attn. @ 1 GHz	Power @ 1 GHz		
1 piece price shown. See web or call for volume pricing.	0.242" dia.			12 dB/100ft	77 W		
12"	24"	36"	48"	60"	72"	Custom Len.	35
\$110.88	\$111.77	\$112.68	\$113.57	\$114.47	\$115.37	See Web	

**HN MALE RIGHT ANGLE TO HN FEMALE**



**Standard Flexible Cable Assemblies**

RG213/U Coax, 50 Ohm							
Part No. <a href="#">PE3W05081</a>	Cable Dia.			Attn. @ 1 GHz	Power @ 1 GHz		
1 piece price shown. See web or call for volume pricing.	0.405" dia.			dB/100ft	190 W		
12"	24"	36"	48"	60"	50CM	Custom Len.	36
\$135.66	\$137.52	\$139.38	\$141.24	\$143.10	\$136.85	See Web	

**LC MALE TO LC MALE**



**Standard Flexible Cable Assemblies**

RG214/U Coax, 50 Ohm							
Part No. <a href="#">PE33491</a>	Cable Dia.			Attn. @ 1 GHz	Power @ 1 GHz		
1 piece price shown. See web or call for volume pricing.	0.425" dia.			7 dB/100ft	190 W		
60"	72"	84"	96"	108"	120"	Custom Len.	37
\$355.68	\$363.06	\$370.46	\$377.81	\$385.21	\$392.60	See Web	

RG217/U Coax, 50 Ohm							
Part No. <a href="#">PE33537</a>	Cable Dia.			Attn. @ 1 GHz	Power @ 1 GHz		
1 piece price shown. See web or call for volume pricing.	0.545" dia.			6 dB/100ft	260 W		
60"	72"	84"	96"	108"	120"	Custom Len.	38
\$400.13	\$404.53	\$408.93	\$413.33	\$417.74	\$422.15	See Web	

Cable Assemblies

See Our Website For Current Pricing & Real-Time Stock Availability!

For Custom Lengths, Metric Lengths or Special Configurations, Please call (949) 261-1920



Technical Support  
+1 (949) 261-1920



Same-Day Shipping,  
Even Custom Cable Assemblies

For our complete selection of cable assemblies, please visit our website

Cable Assemblies

See Our Website For Current Pricing & Real-Time Stock Availability!

RG218/U Coax, 50 Ohm						
Part No.	Cable Dia.			Attn. @ 1 GHz	Power @ 1 GHz	
Part No. <b>PE3960</b>	0.870" dia.			4 dB/100ft	560 W	39
1 piece price shown. See web or call for volume pricing.						
60"	72"	84"	96"	108"	120"	Custom Len.
\$528.89	\$509.56	\$521.06	\$532.55	\$544.04	\$555.54	See Web



**Standard Flexible Cable Assemblies**

RG393/U Coax, 50 Ohm						
Part No.	Cable Dia.			Attn. @ 1 GHz	Power @ 1 GHz	
Part No. <b>PE3W00314</b>	0.390" dia.			dB/100ft	1700 W	42
1 piece price shown. See web or call for volume pricing.						
12"	24"	36"	48"	60"	50CM	Custom Len.
\$302.57	\$318.50	\$334.42	\$350.35	\$366.28	\$312.77	See Web



**Standard Flexible Cable Assemblies**

RG178B/U Coax, 50 Ohm						
Part No.	Cable Dia.			Attn. @ 1 GHz	Power @ 1 GHz	
Part No. <b>PE36116</b>	0.072" dia.			44 dB/100ft	78 W	43
1 piece price shown. See web or call for volume pricing.						
12"	24"	36"	48"	60"	72"	Custom Len.
\$41.85	\$42.82	\$43.76	\$44.74	\$45.71	\$46.64	See Web



**Standard Flexible Cable Assemblies**

RG174A/U Coax, 50 Ohm						
Part No.	Cable Dia.			Attn. @ 1 GHz	Power @ 1 GHz	
Part No. <b>PE3C3387</b>	0.110" dia.			32 dB/100ft	17 W	44
1 piece price shown. See web or call for volume pricing.						
12"	24"	36"	48"	60"	39.37"	Custom Len.
\$35.82	\$36.39	\$36.95	\$37.51	\$38.07	Call	See Web



**Standard Flexible Cable Assemblies**

RG174A/U Coax, 50 Ohm						
Part No.	Cable Dia.			Attn. @ 1 GHz	Power @ 1 GHz	
Part No. <b>PE3295</b>	0.110" dia.			32 dB/100ft	17 W	45
1 piece price shown. See web or call for volume pricing.						
12"	24"	36"	48"	60"	72"	Custom Len.
\$46.44	\$46.87	\$47.32	\$47.75	\$48.18	\$48.61	See Web

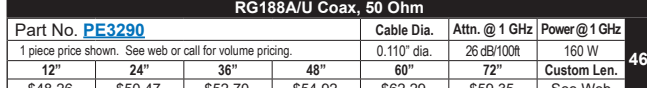

**Standard Flexible Cable Assemblies**

RG188A/U Coax, 50 Ohm						
Part No.	Cable Dia.			Attn. @ 1 GHz	Power @ 1 GHz	
Part No. <b>PE3290</b>	0.110" dia.			26 dB/100ft	160 W	46
1 piece price shown. See web or call for volume pricing.						
12"	24"	36"	48"	60"	72"	Custom Len.
\$48.26	\$50.47	\$52.70	\$54.92	\$62.29	\$59.35	See Web



**Standard Flexible Cable Assemblies**

RG196A/U Coax, 50 Ohm						
Part No.	Cable Dia.			Attn. @ 1 GHz	Power @ 1 GHz	
Part No. <b>PE3293</b>	0.080" dia.			49 dB/100ft	78 W	47
1 piece price shown. See web or call for volume pricing.						
12"	24"	36"	48"	60"	72"	Custom Len.
\$55.51	\$56.89	\$58.27	\$59.63	\$61.00	\$62.37	See Web

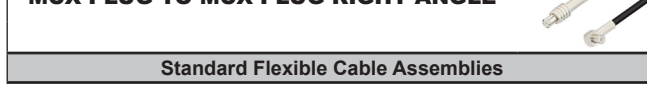

**Standard Flexible Cable Assemblies**

RG316/U Coax, 50 Ohm						
Part No.	Cable Dia.			Attn. @ 1 GHz	Power @ 1 GHz	
Part No. <b>PE3297</b>	0.102" dia.			38 dB/100ft	W	48
1 piece price shown. See web or call for volume pricing.						
12"	24"	36"	48"	60"	72"	Custom Len.
\$51.15	\$51.13	\$54.02	\$56.91	\$63.89	\$62.69	See Web

**Standard Flexible Cable Assemblies**

RG316-DS Coax, 50 Ohm						
Part No.	Cable Dia.			Attn. @ 1 GHz	Power @ 1 GHz	
Part No. <b>PE36799</b>	0.114" dia.			26 dB/100ft	160 W	49
1 piece price shown. See web or call for volume pricing.						
12"	24"	36"	48"	60"	-	Custom Len.
\$45.34	\$48.25	\$55.22	\$54.07	\$56.99	-	See Web

RG174A/U Coax, 50 Ohm						
Part No.	Cable Dia.			Attn. @ 1 GHz	Power @ 1 GHz	
Part No. <b>PE3314</b>	0.110" dia.			32 dB/100ft	17 W	50
1 piece price shown. See web or call for volume pricing.						
12"	24"	36"	48"	60"	72"	Custom Len.
\$48.83	\$49.27	\$49.70	\$50.13	\$50.57	\$51.00	See Web



**Flexible Cable Assemblies**

LMR-100A-PVC Coax, 50 Ohm						
Part No.	Cable Dia.			Attn. @ 1 GHz	Power @ 1 GHz	
Part No. <b>PE3W06468</b>	0.110" dia.			24 dB/100ft	W	53
1 piece price shown. See web or call for volume pricing.						
12"	24"	36"	48"	60"	50CM	Custom Len.
\$37.14	\$37.86	\$38.59	\$39.32	\$40.04	\$37.60	See Web



**Standard Flexible Cable Assemblies**

RG174A/U Coax, 50 Ohm						
Part No.	Cable Dia.			Attn. @ 1 GHz	Power @ 1 GHz	
Part No. <b>PE3W03310</b>	0.110" dia.			32 dB/100ft	17 W	54
1 piece price shown. See web or call for volume pricing.						
12"	24"	36"	48"	60"	50CM	Custom Len.
\$82.30	\$82.86	\$83.42	\$83.98	\$84.54	\$82.65	See Web

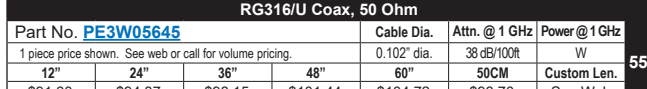

**Standard Flexible Cable Assemblies**

RG316/U Coax, 50 Ohm						
Part No.	Cable Dia.			Attn. @ 1 GHz	Power @ 1 GHz	
Part No. <b>PE3W05645</b>	0.102" dia.			38 dB/100ft	W	55
1 piece price shown. See web or call for volume pricing.						
12"	24"	36"	48"	60"	50CM	Custom Len.
\$91.60	\$94.87	\$98.15	\$101.44	\$104.72	\$93.70	See Web

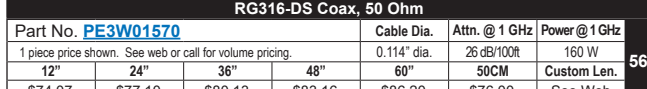

**Standard Flexible Cable Assemblies**

RG316-DS Coax, 50 Ohm						
Part No.	Cable Dia.			Attn. @ 1 GHz	Power @ 1 GHz	
Part No. <b>PE3W01570</b>	0.114" dia.			26 dB/100ft	160 W	56
1 piece price shown. See web or call for volume pricing.						
12"	24"	36"	48"	60"	50CM	Custom Len.
\$74.07	\$77.10	\$80.13	\$83.16	\$86.20	\$76.00	See Web

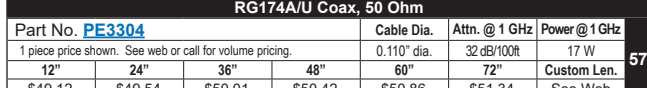

**Standard Flexible Cable Assemblies**

RG174A/U Coax, 50 Ohm						
Part No.	Cable Dia.			Attn. @ 1 GHz	Power @ 1 GHz	
Part No. <b>PE3304</b>	0.110" dia.			32 dB/100ft	17 W	57
1 piece price shown. See web or call for volume pricing.						
12"	24"	36"	48"	60"	72"	Custom Len.
\$49.12	\$49.54	\$50.01	\$50.42	\$50.86	\$51.34	See Web

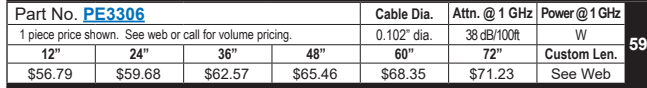

**Standard Flexible Cable Assemblies**

RG188A/U Coax, 50 Ohm						
Part No.	Cable Dia.			Attn. @ 1 GHz	Power @ 1 GHz	
Part No. <b>PE3299</b>	0.110" dia.			26 dB/100ft	160 W	58
1 piece price shown. See web or call for volume pricing.						
12"	24"	36"	48"	60"	72"	Custom Len.
\$54.87	\$57.09	\$59.32	\$61.53	\$63.75	\$65.97	See Web

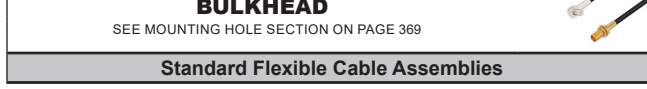

**Standard Flexible Cable Assemblies**

RG316/U Coax, 50 Ohm						
Part No.	Cable Dia.			Attn. @ 1 GHz	Power @ 1 GHz	
Part No. <b>PE3306</b>	0.102" dia.			38 dB/100ft	W	59
1 piece price shown. See web or call for volume pricing.						
12"	24"	36"	48"	60"	72"	Custom Len.
\$56.79	\$59.68	\$62.57	\$65.46	\$68.35	\$71.23	See Web

**Standard Flexible Cable Assemblies**

RG316-DS Coax, 50 Ohm						
Part No.	Cable Dia.			Attn. @ 1 GHz	Power @ 1 GHz	
Part No. <b>PE37099</b>	0.114" dia.			26 dB/100ft	160 W	60
1 piece price shown. See web or call for volume pricing.						
12"	24"	36"	48"	60"	-	Custom Len.
\$56.65	\$59.55	\$67.43	\$65.37	\$68.28	-	See Web

\*Coax Performance at 1 GHz Notes: Cable assembly max frequency may be lower than connector or coax max frequency

For our complete selection of cable assemblies, please visit our website

RG174A/U Coax, 50 Ohm						
Part No. <a href="#">PE3W01300</a>	Cable Dia.			Attn. @ 1 GHz	Power @ 1 GHz	
1 piece price shown. See web or call for volume pricing.	0.110" dia.			32 dB/100ft	17 W	
12"	24"	36"	48"	60"	50CM	Custom Len.
\$53.54	\$61.03	\$61.59	\$62.15	\$62.71	\$60.82	See Web

**MCX PLUG RIGHT ANGLE TO SMA MALE**



**Standard Formable Cable Assemblies**

PE-SR405FLJ Coax, 50 Ohm						
Part No. <a href="#">PE3W07396</a>	Cable Dia.			Attn. @ 1 GHz	Power @ 1 GHz	
1 piece price shown. See web or call for volume pricing.	0.105" dia.			20 dB/100ft	122 W	
12"	24"	36"	48"	60"	50CM	Custom Len.
\$95.17	\$104.12	\$113.07	\$122.03	\$130.91	\$100.91	See Web

**MCX JACK TO MCX JACK**



**Standard Flexible Cable Assemblies**

RG178B/U Coax, 50 Ohm						
Part No. <a href="#">PE3W00099</a>	Cable Dia.			Attn. @ 1 GHz	Power @ 1 GHz	
1 piece price shown. See web or call for volume pricing.	0.072" dia.			44 dB/100ft	78 W	
12"	24"	36"	48"	60"	50CM	Custom Len.
\$68.42	\$69.54	\$70.67	\$71.81	\$72.94	\$69.14	See Web

**MHV MALE TO MHV MALE**



**Standard Flexible Cable Assemblies**

RG8A/U Coax, 50 Ohm						
Part No. <a href="#">PE3098</a>	Cable Dia.			Attn. @ 1 GHz	Power @ 1 GHz	
1 piece price shown. See web or call for volume pricing.	0.405" dia.			8 dB/100ft	190 W	
12"	24"	36"	48"	60"	72"	Custom Len.
\$94.22	\$102.94	\$99.88	\$102.72	\$112.39	\$115.53	See Web

**RG58C/U Coax, 50 Ohm**

Part No. <a href="#">PE3516</a>	Cable Dia.			Attn. @ 1 GHz	Power @ 1 GHz	
1 piece price shown. See web or call for volume pricing.	0.195" dia.			20 dB/100ft	44 W	
12"	24"	36"	48"	60"	72"	Custom Len.
\$77.77	\$78.58	\$79.39	\$80.25	\$81.08	\$81.91	See Web

**RG141A/U Coax, 50 Ohm**

Part No. <a href="#">PE34429</a>	Cable Dia.			Attn. @ 1 GHz	Power @ 1 GHz	
1 piece price shown. See web or call for volume pricing.	0.190" dia.			13 dB/100ft	650 W	
12"	24"	36"	48"	60"	72"	Custom Len.
\$85.59	\$92.05	\$104.53	\$111.84	\$118.87	\$117.87	See Web

**RG142B/U Coax, 50 Ohm**

Part No. <a href="#">PE3914</a>	Cable Dia.			Attn. @ 1 GHz	Power @ 1 GHz	
1 piece price shown. See web or call for volume pricing.	0.195" dia.			13 dB/100ft	W	
12"	24"	36"	48"	60"	72"	Custom Len.
\$59.09	\$64.81	\$70.55	\$75.04	\$82.01	\$87.42	See Web

**RG174A/U Coax, 50 Ohm**

Part No. <a href="#">PE34427</a>	Cable Dia.			Attn. @ 1 GHz	Power @ 1 GHz	
1 piece price shown. See web or call for volume pricing.	0.100" dia.			32 dB/100ft	16 W	
12"	24"	36"	48"	60"	72"	Custom Len.
\$98.06	\$98.50	\$103.14	\$99.37	\$104.34	\$104.93	See Web

**RG188A/U Coax, 50 Ohm**

Part No. <a href="#">PE34431</a>	Cable Dia.			Attn. @ 1 GHz	Power @ 1 GHz	
1 piece price shown. See web or call for volume pricing.	0.110" dia.			26 dB/100ft	160 W	
12"	24"	36"	48"	60"	72"	Custom Len.
\$101.72	\$103.94	\$106.15	\$108.38	\$110.60	\$112.81	See Web

**RG214/U Coax, 50 Ohm**

Part No. <a href="#">PE3735</a>	Cable Dia.			Attn. @ 1 GHz	Power @ 1 GHz	
1 piece price shown. See web or call for volume pricing.	0.425" dia.			7 dB/100ft	190 W	
12"	24"	36"	48"	60"	72"	Custom Len.
\$106.80	\$108.08	\$122.35	\$122.74	\$130.06	\$137.38	See Web

**RG223/U Coax, 50 Ohm**

Part No. <a href="#">PE3694</a>	Cable Dia.			Attn. @ 1 GHz	Power @ 1 GHz	
1 piece price shown. See web or call for volume pricing.	0.210" dia.			13 dB/100ft	53 W	
12"	24"	36"	48"	60"	72"	Custom Len.
\$59.61	\$59.13	\$62.03	\$69.12	\$67.83	\$75.47	See Web

**RG225/U Coax, 50 Ohm**

Part No. <a href="#">PE34423</a>	Cable Dia.			Attn. @ 1 GHz	Power @ 1 GHz	
1 piece price shown. See web or call for volume pricing.	0.430" dia.			dB/100ft	1700 W	
12"	24"	36"	48"	60"	72"	Custom Len.
\$118.49	\$151.08	\$183.66	\$216.26	\$248.85	\$281.43	See Web

**RG393/U Coax, 50 Ohm**

Part No. <a href="#">PE3577</a>	Cable Dia.			Attn. @ 1 GHz	Power @ 1 GHz	
1 piece price shown. See web or call for volume pricing.	0.390" dia.			9 dB/100ft	1700 W	
12"	24"	36"	48"	60"	72"	Custom Len.
\$107.60	\$130.46	\$138.53	\$154.00	\$169.46	\$184.93	See Web

**RG400/U Coax, 50 Ohm**

Part No. <a href="#">PE34425</a>	Cable Dia.			Attn. @ 1 GHz	Power @ 1 GHz	
1 piece price shown. See web or call for volume pricing.	0.195" dia.			15 dB/100ft	650 W	
12"	24"	36"	48"	60"	72"	Custom Len.
\$67.18	\$74.15	\$81.13	\$88.09	\$95.06	\$108.91	See Web

**RG59B/U Coax, 75 Ohm**

Part No. <a href="#">PE3542</a>	Cable Dia.			Attn. @ 1 GHz	Power @ 1 GHz	
1 piece price shown. See web or call for volume pricing.	0.242" dia.			12 dB/100ft	77 W	
12"	24"	36"	48"	60"	72"	Custom Len.
\$45.40	\$50.08	\$51.11	\$48.28	\$53.27	\$54.33	See Web

Part No. <a href="#">PE3517</a>	Cable Dia.			Attn. @ 1 GHz	Power @ 1 GHz	
1 piece price shown. See web or call for volume pricing.	0.242" dia.			13 dB/100ft	77 W	
12"	24"	36"	48"	60"	72"	Custom Len.
\$48.60	\$50.14	\$51.68	\$49.97	\$51.35	\$56.46	See Web

**MHV MALE TO MHV MALE RIGHT ANGLE**



**Standard Flexible Cable Assemblies**

RG174A/U Coax, 50 Ohm						
Part No. <a href="#">PE35799</a>	Cable Dia.			Attn. @ 1 GHz	Power @ 1 GHz	
1 piece price shown. See web or call for volume pricing.	0.100" dia.			32 dB/100ft	16 W	
12"	24"	36"	48"	60"	-	Custom Len.
\$102.79	\$103.37	\$103.94	\$98.27	\$98.71	-	See Web

**MHV MALE TO SHV PLUG**



**Standard Flexible Cable Assemblies**

RG8A/U Coax, 50 Ohm						
Part No. <a href="#">PE3365</a>	Cable Dia.			Attn. @ 1 GHz	Power @ 1 GHz	
1 piece price shown. See web or call for volume pricing.	0.405" dia.			8 dB/100ft	190 W	
12"	24"	36"	48"	60"	72"	Custom Len.
\$95.72	\$98.56	\$101.39	\$104.22	\$107.05	\$109.88	See Web

Part No. <a href="#">PE3950</a>	Cable Dia.			Attn. @ 1 GHz	Power @ 1 GHz	
1 piece price shown. See web or call for volume pricing.	0.195" dia.			20 dB/100ft	44 W	
12"	24"	36"	48"	60"	72"	Custom Len.
\$88.97	\$96.90	\$97.72	\$91.17	\$99.40	\$100.23	See Web

Part No. <a href="#">PE34413</a>	Cable Dia.			Attn. @ 1 GHz	Power @ 1 GHz	
1 piece price shown. See web or call for volume pricing.	0.190" dia.			13 dB/100ft	650 W	
12"	24"	36"	48"	60"	72"	Custom Len.
\$94.17	\$100.63	\$117.40	\$124.70	\$119.99	\$126.46	See Web

Part No. <a href="#">PE3085</a>	Cable Dia.			Attn. @ 1 GHz	Power @ 1 GHz	
1 piece price shown. See web or call for volume pricing.	0.195" dia.			13 dB/100ft	W	
12"	24"	36"	48"	60"	72"	Custom Len.
\$87.66	\$93.40	\$99.12	\$104.85	\$110.58	\$123.90	See Web

Part No. <a href="#">PE34419</a>	Cable Dia.			Attn. @ 1 GHz	Power @ 1 GHz	
1 piece price shown. See web or call for volume pricing.	0.100" dia.			32 dB/100ft	16 W	
12"	24"	36"	48"	60"	72"	Custom Len.
\$102.68	\$97.31	\$103.85	\$98.21	\$98.62	\$99.10	See Web

Part No. <a href="#">PE34415</a>	Cable Dia.			Attn. @ 1 GHz	Power @ 1 GHz	
1 piece price shown. See web or call for volume pricing.	0.110" dia.			26 dB/100ft	160 W	
12"	24"	36"	48"	60"	72"	Custom Len.
\$98.57	\$100.73	\$102.82	\$104.99	\$107.10	\$109.24	See Web

Part No. <a href="#">PE33516</a>	Cable Dia.			Attn. @ 1 GHz	Power @ 1 GHz	
1 piece price shown. See web or call for volume pricing.	0.425" dia.			7 dB/100ft	190 W	
12"	24"	36"	48"	60"	72"	Custom Len.
\$108.40	\$109.59	\$116.92	\$124.23	\$140.12	\$138.89	See Web

Part No. <a href="#">PE34411</a>	Cable Dia.			Attn. @ 1 GHz	Power @ 1 GHz	
1 piece price shown. See web or call for volume pricing.	0.210" dia.			13 dB/100ft	53 W	
12"	24"	36"	48"	60"	72"	Custom Len.
\$72.16	\$75.07	\$82.71	\$80.87	\$83.75	\$92.36	See Web

Part No. <a href="#">PE33984</a>	Cable Dia.			Attn. @ 1 GHz	Power @ 1 GHz	
1 piece price shown. See web or call for volume pricing.	0.390" dia.			8 dB/100ft	1700 W	
12"	24"	36"	48"	60"	72"	Custom Len.
\$110.22	\$125.68	\$141.15	\$156.62	\$172.08	\$187.55	See Web

Part No. <a href="#">PE34409</a>	Cable Dia.			Attn. @ 1 GHz	Power @ 1 GHz	
1 piece price shown. See web or call for volume pricing.	0.195" dia.			15 dB/100ft	650 W	
12"	24"	36"	48"	60"	72"	Custom Len.
\$76.91	\$83.92	\$90.95	\$97.97	\$104.99	\$119.21	See Web

Part No. <a href="#">PE3108</a>	Cable Dia.			Attn. @ 1 GHz	Power @ 1 GHz	
1 piece price shown. See web or call for volume pricing.	0.242" dia.			12 dB/100ft	77 W	
12"	24"	36"	48"	60"	72"	Custom Len.
\$73.95	\$74.98	\$70.39	\$77.12	\$72.30	\$79.23	See Web

Cable Assemblies

See Our Website For Current Pricing & Real-Time Stock Availability!

For Custom Lengths, Metric Lengths or Special Configurations, Please call (949) 261-1920



Technical Support  
+1 (949) 261-1920



Same-Day Shipping,  
Even Custom Cable Assemblies

For our complete selection of cable assemblies, please visit our website

Cable Assemblies

See Our Website For Current Pricing & Real-Time Stock Availability!

RG62A/U Coax, 93 Ohm						
Part No. <a href="#">PE3451</a>	Cable Dia.	Attn. @ 1 GHz	Power @ 1 GHz			
1 piece price shown. See web or call for volume pricing.						
12"	24"	36"	48"	60"	72"	Custom Len.
\$67.66	\$69.03	\$70.41	\$71.77	\$73.15	\$74.53	See Web

**MINI UHF MALE TO MINI UHF MALE**



**Standard Flexible Cable Assemblies**

RG58C/U Coax, 50 Ohm						
Part No. <a href="#">PE3258</a>	Cable Dia.	Attn. @ 1 GHz	Power @ 1 GHz			
1 piece price shown. See web or call for volume pricing.						
12"	24"	36"	48"	60"	72"	Custom Len.
\$32.12	\$32.85	\$33.59	\$34.33	\$38.64	\$35.79	See Web

RG142B/U Coax, 50 Ohm						
Part No. <a href="#">PE3263</a>	Cable Dia.	Attn. @ 1 GHz	Power @ 1 GHz			
1 piece price shown. See web or call for volume pricing.						
12"	24"	36"	48"	60"	72"	Custom Len.
\$32.04	\$35.19	\$40.77	\$46.29	\$51.88	\$57.39	See Web

RG223/U Coax, 50 Ohm						
Part No. <a href="#">PE3265</a>	Cable Dia.	Attn. @ 1 GHz	Power @ 1 GHz			
1 piece price shown. See web or call for volume pricing.						
12"	24"	36"	48"	60"	72"	Custom Len.
\$27.02	\$29.98	\$35.96	\$35.79	\$38.73	\$41.62	See Web

RG400/U Coax, 50 Ohm						
Part No. <a href="#">PE3269</a>	Cable Dia.	Attn. @ 1 GHz	Power @ 1 GHz			
1 piece price shown. See web or call for volume pricing.						
12"	24"	36"	48"	60"	72"	Custom Len.
\$37.18	\$44.20	\$51.21	\$58.23	\$65.27	\$72.28	See Web

**MMCX PLUG TO MMCX PLUG**



**Standard Flexible Cable Assemblies**

RG174A/U Coax, 50 Ohm						
Part No. <a href="#">PE34879</a>	Cable Dia.	Attn. @ 1 GHz	Power @ 1 GHz			
1 piece price shown. See web or call for volume pricing.						
12"	24"	36"	48"	60"	72"	Custom Len.
\$58.36	\$54.47	\$59.51	\$55.35	\$55.78	\$56.22	See Web

RG178B/U Coax, 50 Ohm						
Part No. <a href="#">PE34598</a>	Cable Dia.	Attn. @ 1 GHz	Power @ 1 GHz			
1 piece price shown. See web or call for volume pricing.						
12"	24"	36"	48"	60"	72"	Custom Len.
\$59.15	\$60.20	\$55.69	\$56.65	\$57.60	\$58.57	See Web

RG188A/U Coax, 50 Ohm						
Part No. <a href="#">PE34599</a>	Cable Dia.	Attn. @ 1 GHz	Power @ 1 GHz			
1 piece price shown. See web or call for volume pricing.						
4"	-	-	-	-	-	Custom Len.
\$88.57	-	-	-	-	-	See Web

RG188A/U Coax, 50 Ohm						
Part No. <a href="#">PE34885</a>	Cable Dia.	Attn. @ 1 GHz	Power @ 1 GHz			
1 piece price shown. See web or call for volume pricing.						
12"	24"	36"	48"	60"	72"	Custom Len.
\$50.81	\$52.96	\$55.06	\$57.21	\$59.32	\$61.49	See Web

RG196A/U Coax, 50 Ohm						
Part No. <a href="#">PE34891</a>	Cable Dia.	Attn. @ 1 GHz	Power @ 1 GHz			
1 piece price shown. See web or call for volume pricing.						
12"	24"	36"	48"	60"	72"	Custom Len.
\$49.23	\$50.57	\$51.88	\$53.21	\$54.51	\$55.84	See Web

RG316/U Coax, 50 Ohm						
Part No. <a href="#">PE34240</a>	Cable Dia.	Attn. @ 1 GHz	Power @ 1 GHz			
1 piece price shown. See web or call for volume pricing.						
12"	24"	36"	48"	60"	72"	Custom Len.
\$56.21	\$59.34	\$62.57	\$65.46	\$68.35	\$71.23	See Web

RG316-DS Coax, 50 Ohm						
Part No. <a href="#">PE38679</a>	Cable Dia.	Attn. @ 1 GHz	Power @ 1 GHz			
1 piece price shown. See web or call for volume pricing.						
12"	24"	36"	48"	60"	-	Custom Len.
\$51.63	\$54.53	\$57.44	\$60.36	\$63.26	-	See Web

**MMCX PLUG TO MMCX PLUG RIGHT ANGLE**



**Low Loss Flexible Cable Assemblies**

PE-C100-LSZH Coax, 50 Ohm						
Part No. <a href="#">PE38231</a>	Cable Dia.	Attn. @ 1 GHz	Power @ 1 GHz			
1 piece price shown. See web or call for volume pricing.						
12"	24"	36"	48"	60"	-	Custom Len.
\$48.54	\$49.74	\$50.94	\$52.16	\$53.35	-	See Web

**Standard Formable Cable Assemblies**

PE-SR047FL Coax, 50 Ohm						
Part No. <a href="#">PE38231</a>	Cable Dia.	Attn. @ 1 GHz	Power @ 1 GHz			
1 piece price shown. See web or call for volume pricing.						
12"	24"	36"	48"	60"	-	Custom Len.
\$48.54	\$49.74	\$50.94	\$52.16	\$53.35	-	See Web

Part No. <a href="#">PE38322</a>				Cable Dia.	Attn. @ 1 GHz	Power @ 1 GHz
1 piece price shown. See web or call for volume pricing.						
12"	24"	36"	48"	0.047" dia.	36 dB/100ft	32 W
\$82.37	\$85.08	\$92.44	\$99.82	\$107.18	-	Custom Len.
See Web						

**Standard Flexible Cable Assemblies**

RG174A/U Coax, 50 Ohm						
Part No. <a href="#">PE34881</a>	Cable Dia.	Attn. @ 1 GHz	Power @ 1 GHz			
1 piece price shown. See web or call for volume pricing.						
12"	24"	36"	48"	60"	72"	Custom Len.
\$61.71	\$62.29	\$58.02	\$58.44	\$58.88	\$59.32	See Web

RG178B/U Coax, 50 Ohm						
Part No. <a href="#">PE34883</a>	Cable Dia.	Attn. @ 1 GHz	Power @ 1 GHz			
1 piece price shown. See web or call for volume pricing.						
12"	24"	36"	48"	60"	72"	Custom Len.
\$62.23	\$63.18	\$63.14	\$65.10	\$66.06	\$67.02	See Web

RG188A/U Coax, 50 Ohm						
Part No. <a href="#">PE34889</a>	Cable Dia.	Attn. @ 1 GHz	Power @ 1 GHz			
1 piece price shown. See web or call for volume pricing.						
12"	24"	36"	48"	60"	72"	Custom Len.
\$58.98	\$67.38	\$63.43	\$65.64	\$67.87	\$70.08	See Web

RG196A/U Coax, 50 Ohm						
Part No. <a href="#">PE34893</a>	Cable Dia.	Attn. @ 1 GHz	Power @ 1 GHz			
1 piece price shown. See web or call for volume pricing.						
12"	24"	36"	48"	60"	72"	Custom Len.
\$56.92	\$58.23	\$59.57	\$60.89	\$62.20	\$63.52	See Web

RG316/U Coax, 50 Ohm						
Part No. <a href="#">PE34895</a>	Cable Dia.	Attn. @ 1 GHz	Power @ 1 GHz			
1 piece price shown. See web or call for volume pricing.						
12"	24"	36"	48"	60"	72"	Custom Len.
\$65.89	\$69.01	\$65.68	\$68.56	\$71.46	\$74.34	See Web

**MMCX PLUG TO N FEMALE BULKHEAD**

SEE MOUNTING HOLE SECTION ON PAGE 369



**Formable Cable Assemblies**

PE-SR047FL Coax, 50 Ohm						
Part No. <a href="#">PE3W07591</a>	Cable Dia.	Attn. @ 1 GHz	Power @ 1 GHz			
1 piece price shown. See web or call for volume pricing.						
12"	24"	36"	48"	* dia.	36 dB/100ft	32 W
\$87.48	\$96.15	\$104.82	\$113.50	\$122.18	\$93.04	Custom Len.
See Web						

**MMCX PLUG TO SMC PLUG**



**Standard Flexible Cable Assemblies**

RG178B/U Coax, 50 Ohm						
Part No. <a href="#">PE3W07653</a>	Cable Dia.	Attn. @ 1 GHz	Power @ 1 GHz			
1 piece price shown. See web or call for volume pricing.						
12"	24"	36"	48"	60"	50CM	Custom Len.
\$48.52	\$49.64	\$50.78	\$51.91	\$53.04	\$49.24	See Web

**MMCX PLUG RIGHT ANGLE TO BNC FEMALE BULKHEAD**

SEE MOUNTING HOLE SECTION ON PAGE 369



**Standard Flexible Cable Assemblies**

RG174A/U Coax, 50 Ohm						
Part No. <a href="#">PE36738</a>	Cable Dia.	Attn. @ 1 GHz	Power @ 1 GHz			
1 piece price shown. See web or call for volume pricing.						
12"	24"	36"	48"	60"	-	Custom Len.
\$58.10	\$58.67	\$59.25	\$56.12	\$60.45	-	See Web

**MMCX PLUG RIGHT ANGLE TO MMCX PLUG**



**Standard Formable Cable Assemblies**

PE-SR405FLJ Coax, 50 Ohm						
Part No. <a href="#">PE3W05483</a>	Cable Dia.	Attn. @ 1 GHz	Power @ 1 GHz			
1 piece price shown. See web or call for volume pricing.						
12"	24"	36"	48"	60"	50CM	Custom Len.
\$52.83	\$73.36	\$82.32	\$91.28	\$100.23	\$70.15	See Web

**MMCX PLUG RIGHT ANGLE TO SMA MALE RIGHT ANGLE**



**Standard Flexible Cable Assemblies**

RG316/U Coax, 50 Ohm						
Part No. <a href="#">PE3W07894</a>	Cable Dia.	Attn. @ 1 GHz	Power @ 1 GHz			
1 piece price shown. See web or call for volume pricing.						
12"	18"	24"	36"	48"	60"	Custom Len.
\$70.20	\$71.78	\$73.36	\$76.52	\$79.68	\$82.84	See Web

\*Coax Performance at 1 GHz Notes: Cable assembly max frequency may be lower than connector or coax max frequency

For our complete selection of cable assemblies, please visit our website

MMCX PLUG RIGHT ANGLE TO SMA FEMALE						
Standard Flexible Cable Assemblies						
RG188-DS Coax, 50 Ohm						
Part No. <a href="#">PE3W07068</a>	Cable Dia.	Attn. @ 1 GHz	Power @ 1 GHz			
1 piece price shown. See web or call for volume pricing.	0.118" dia.	30 dB/100ft	160 W			
12"	24"	36"	48"	60"	50CM	Custom Len.
\$59.70	Call	Call	Call	Call	Call	See Web
MMBX PLUG TO MMBX PLUG						
Standard Formable Cable Assemblies						
PE-SR405FLJ Coax, 50 Ohm						
Part No. <a href="#">PE3C4064</a>	Cable Dia.	Attn. @ 1 GHz	Power @ 1 GHz			
1 piece price shown. See web or call for volume pricing.	0.098" dia.	20 dB/100ft	122 W			
4"	6"	8"	12"	18"	24"	Custom Len.
\$50.10	\$51.36	\$52.61	\$60.64	\$58.88	\$62.65	See Web
Standard Flexible Cable Assemblies						
RG178B/U Coax, 50 Ohm						
Part No. <a href="#">PE3C3985</a>	Cable Dia.	Attn. @ 1 GHz	Power @ 1 GHz			
1 piece price shown. See web or call for volume pricing.	0.072" dia.	44 dB/100ft	55 W			
4"	6"	8"	12"	18"	24"	Custom Len.
\$44.78	\$44.94	\$45.09	\$45.41	\$45.87	\$46.34	See Web
Standard Flexible Cable Assemblies						
RG316-DS Coax, 50 Ohm						
Part No. <a href="#">PE3C4048</a>	Cable Dia.	Attn. @ 1 GHz	Power @ 1 GHz			
1 piece price shown. See web or call for volume pricing.	0.114" dia.	9 dB/100ft	85 W			
4"	6"	8"	12"	18"	24"	Custom Len.
\$45.43	\$45.88	\$46.36	\$47.31	\$48.71	\$50.13	See Web
MMBX PLUG TO MMBX PLUG RIGHT ANGLE						
Standard Flexible Cable Assemblies						
RG178B/U Coax, 50 Ohm						
Part No. <a href="#">PE3C3986</a>	Cable Dia.	Attn. @ 1 GHz	Power @ 1 GHz			
1 piece price shown. See web or call for volume pricing.	0.072" dia.	44 dB/100ft	55 W			
4"	6"	8"	12"	18"	24"	Custom Len.
\$48.57	\$48.72	\$48.88	\$49.20	\$49.66	\$50.13	See Web
MMBX PLUG TO SMA MALE						
Standard Formable Cable Assemblies						
PE-SR405FLJ Coax, 50 Ohm						
Part No. <a href="#">PE3C4068</a>	Cable Dia.	Attn. @ 1 GHz	Power @ 1 GHz			
1 piece price shown. See web or call for volume pricing.	0.098" dia.	20 dB/100ft	122 W			
4"	6"	8"	12"	18"	24"	Custom Len.
\$49.14	\$45.94	\$47.20	\$49.71	\$53.47	\$57.24	See Web
Standard Flexible Cable Assemblies						
RG174A/U Coax, 50 Ohm						
Part No. <a href="#">PE3C4036</a>	Cable Dia.	Attn. @ 1 GHz	Power @ 1 GHz			
1 piece price shown. See web or call for volume pricing.	0.110" dia.	32 dB/100ft	17 W			
4"	6"	8"	12"	18"	24"	Custom Len.
\$41.99	\$42.06	\$42.13	\$42.27	\$42.47	\$47.07	See Web
Standard Flexible Cable Assemblies						
RG178B/U Coax, 50 Ohm						
Part No. <a href="#">PE3C3989</a>	Cable Dia.	Attn. @ 1 GHz	Power @ 1 GHz			
1 piece price shown. See web or call for volume pricing.	0.072" dia.	44 dB/100ft	55 W			
4"	6"	8"	12"	18"	24"	Custom Len.
\$49.73	\$49.88	\$50.05	\$50.36	\$50.83	\$51.29	See Web
Standard Flexible Cable Assemblies						
RG316/U Coax, 50 Ohm						
Part No. <a href="#">PE3C4019</a>	Cable Dia.	Attn. @ 1 GHz	Power @ 1 GHz			
1 piece price shown. See web or call for volume pricing.	0.098" dia.	58 dB/100ft	160 W			
4"	6"	8"	12"	18"	24"	Custom Len.
\$42.78	\$43.24	\$43.71	\$44.66	\$46.05	\$52.25	See Web
Standard Flexible Cable Assemblies						
RG316-DS Coax, 50 Ohm						
Part No. <a href="#">PE3C3854</a>	Cable Dia.	Attn. @ 1 GHz	Power @ 1 GHz			
1 piece price shown. See web or call for volume pricing.	0.114" dia.	9 dB/100ft	85 W			
4"	6"	8"	12"	18"	24"	Custom Len.
\$38.05	\$38.52	\$38.99	\$39.93	\$41.34	\$42.75	See Web
MMBX PLUG TO SMA MALE RIGHT ANGLE						
Standard Flexible Cable Assemblies						
RG316/U Coax, 50 Ohm						
Part No. <a href="#">PE3C4027</a>	Cable Dia.	Attn. @ 1 GHz	Power @ 1 GHz			
1 piece price shown. See web or call for volume pricing.	0.098" dia.	58 dB/100ft	160 W			
4"	6"	8"	12"	18"	24"	Custom Len.
\$52.75	\$53.22	\$53.69	\$54.62	\$56.02	\$57.42	See Web

RG316-DS Coax, 50 Ohm						
Part No. <a href="#">PE3C4060</a>	Cable Dia.	Attn. @ 1 GHz	Power @ 1 GHz			
1 piece price shown. See web or call for volume pricing.	0.114" dia.	9 dB/100ft	85 W			
4"	6"	8"	12"	18"	24"	Custom Len.
\$51.34	\$51.79	\$52.27	\$53.22	\$54.62	\$56.04	See Web
MMBX PLUG TO SMA FEMALE						
Standard Flexible Cable Assemblies						
RG316/U Coax, 50 Ohm						
Part No. <a href="#">PE3C4029</a>	Cable Dia.	Attn. @ 1 GHz	Power @ 1 GHz			
1 piece price shown. See web or call for volume pricing.	0.098" dia.	58 dB/100ft	160 W			
4"	6"	8"	12"	18"	24"	Custom Len.
\$51.99	\$52.46	\$52.93	\$59.24	\$55.26	\$56.66	See Web
Standard Flexible Cable Assemblies						
RG316-DS Coax, 50 Ohm						
Part No. <a href="#">PE3C4062</a>	Cable Dia.	Attn. @ 1 GHz	Power @ 1 GHz			
1 piece price shown. See web or call for volume pricing.	0.114" dia.	9 dB/100ft	85 W			
4"	6"	8"	12"	18"	24"	Custom Len.
\$51.33	\$51.78	\$52.26	\$53.21	\$54.61	\$56.03	See Web
MMBX PLUG TO SMA FEMALE BULKHEAD						
SEE MOUNTING HOLE SECTION ON PAGE 369						
Standard Formable Cable Assemblies						
PE-SR405FLJ Coax, 50 Ohm						
Part No. <a href="#">PE3C4066</a>	Cable Dia.	Attn. @ 1 GHz	Power @ 1 GHz			
1 piece price shown. See web or call for volume pricing.	0.098" dia.	20 dB/100ft	122 W			
4"	6"	8"	12"	18"	24"	Custom Len.
\$52.02	\$48.55	\$49.81	\$52.31	\$56.07	\$59.85	See Web
Standard Flexible Cable Assemblies						
RG174A/U Coax, 50 Ohm						
Part No. <a href="#">PE3C4034</a>	Cable Dia.	Attn. @ 1 GHz	Power @ 1 GHz			
1 piece price shown. See web or call for volume pricing.	0.110" dia.	32 dB/100ft	17 W			
4"	6"	8"	12"	18"	24"	Custom Len.
\$47.35	\$47.41	\$47.49	\$47.63	\$52.68	\$48.05	See Web
Standard Flexible Cable Assemblies						
RG178B/U Coax, 50 Ohm						
Part No. <a href="#">PE3C3922</a>	Cable Dia.	Attn. @ 1 GHz	Power @ 1 GHz			
1 piece price shown. See web or call for volume pricing.	0.072" dia.	44 dB/100ft	55 W			
4"	6"	8"	12"	18"	24"	Custom Len.
\$52.61	\$52.76	\$52.93	\$53.24	\$53.79	\$54.17	See Web
MMBX PLUG TO SSMB JACK BULKHEAD						
SEE MOUNTING HOLE SECTION ON PAGE 369						
Standard Flexible Cable Assemblies						
RG316/U Coax, 50 Ohm						
Part No. <a href="#">PE3W07532</a>	Cable Dia.	Attn. @ 1 GHz	Power @ 1 GHz			
1 piece price shown. See web or call for volume pricing.	0.102" dia.	38 dB/100ft	W			
12"	24"	36"	48"	60"	50CM	Custom Len.
\$69.15	\$72.42	\$75.70	\$78.98	\$82.27	\$71.24	See Web
MMBX PLUG TO TNC FEMALE BULKHEAD						
SEE MOUNTING HOLE SECTION ON PAGE 369						
Standard Flexible Cable Assemblies						
RG178B/U Coax, 50 Ohm						
Part No. <a href="#">PE3C3995</a>	Cable Dia.	Attn. @ 1 GHz	Power @ 1 GHz			
1 piece price shown. See web or call for volume pricing.	0.072" dia.	44 dB/100ft	55 W			
4"	6"	8"	12"	18"	24"	Custom Len.
\$56.38	\$53.35	\$53.52	\$53.83	\$54.30	\$54.77	See Web
Standard Flexible Cable Assemblies						
RG316/U Coax, 50 Ohm						
Part No. <a href="#">PE3C4025</a>	Cable Dia.	Attn. @ 1 GHz	Power @ 1 GHz			
1 piece price shown. See web or call for volume pricing.	0.098" dia.	58 dB/100ft	160 W			
4"	6"	8"	12"	18"	24"	Custom Len.
\$56.25	\$56.71	\$57.18	\$63.93	\$59.51	\$60.92	See Web
MMBX PLUG RIGHT ANGLE TO MMBX PLUG RIGHT ANGLE						
Standard Flexible Cable Assemblies						
RG178B/U Coax, 50 Ohm						
Part No. <a href="#">PE3C3987</a>	Cable Dia.	Attn. @ 1 GHz	Power @ 1 GHz			
1 piece price shown. See web or call for volume pricing.	0.072" dia.	44 dB/100ft	55 W			
4"	6"	8"	12"	18"	24"	Custom Len.
\$52.37	\$52.51	\$52.68	\$52.99	\$53.46	\$53.92	See Web
Standard Flexible Cable Assemblies						
RG316/U Coax, 50 Ohm						
Part No. <a href="#">PE3C4016</a>	Cable Dia.	Attn. @ 1 GHz	Power @ 1 GHz			
1 piece price shown. See web or call for volume pricing.	0.098" dia.	58 dB/100ft	160 W			
4"	6"	8"	12"	18"	24"	Custom Len.
\$52.99	\$53.46	\$53.92	\$60.35	\$56.26	\$57.65	See Web

Cable Assemblies

See Our Website For Current Pricing & Real-Time Stock Availability!

For Custom Lengths, Metric Lengths or Special Configurations, Please call (949) 261-1920



Technical Support  
+1 (949) 261-1920



Same-Day Shipping,  
Even Custom Cable Assemblies

For our complete selection of cable assemblies, please visit our website

**MMBX PLUG RIGHT ANGLE TO SMA MALE**



**Standard Formable Cable Assemblies**

**PE-SR405FLJ Coax, 50 Ohm**

Part No. <a href="#">PE3C4069</a>	Cable Dia.	Attn. @ 1 GHz	Power @ 1 GHz
1 piece price shown. See web or call for volume pricing.			
4"	6"	8"	12"
\$51.61	\$48.17	\$49.43	\$51.94
		\$55.70	\$59.46

**Standard Flexible Cable Assemblies**

**RG174A/U Coax, 50 Ohm**

Part No. <a href="#">PE3C4037</a>	Cable Dia.	Attn. @ 1 GHz	Power @ 1 GHz
1 piece price shown. See web or call for volume pricing.			
4"	6"	8"	12"
\$45.78	\$45.84	\$45.92	\$46.06
		\$46.27	\$46.48

**RG178B/U Coax, 50 Ohm**

Part No. <a href="#">PE3C3990</a>	Cable Dia.	Attn. @ 1 GHz	Power @ 1 GHz
1 piece price shown. See web or call for volume pricing.			
4"	6"	8"	12"
\$53.52	\$53.67	\$53.83	\$54.15
		\$54.61	\$55.08

**RG316/U Coax, 50 Ohm**

Part No. <a href="#">PE3C4020</a>	Cable Dia.	Attn. @ 1 GHz	Power @ 1 GHz
1 piece price shown. See web or call for volume pricing.			
4"	6"	8"	12"
\$84.37	\$84.48	\$84.62	\$89.96
		\$85.23	\$93.08

**RG316-DS Coax, 50 Ohm**

Part No. <a href="#">PE3C4053</a>	Cable Dia.	Attn. @ 1 GHz	Power @ 1 GHz
1 piece price shown. See web or call for volume pricing.			
4"	6"	8"	12"
\$41.84	\$42.31	\$42.78	\$43.72
		\$49.65	\$46.55

**MMBX PLUG RIGHT ANGLE TO SMA MALE RIGHT ANGLE**



**Standard Flexible Cable Assemblies**

**RG174A/U Coax, 50 Ohm**

Part No. <a href="#">PE3C4045</a>	Cable Dia.	Attn. @ 1 GHz	Power @ 1 GHz
1 piece price shown. See web or call for volume pricing.			
4"	6"	8"	12"
\$55.75	\$55.82	\$55.89	\$56.03
		\$56.24	\$56.45

**RG316/U Coax, 50 Ohm**

Part No. <a href="#">PE3C4028</a>	Cable Dia.	Attn. @ 1 GHz	Power @ 1 GHz
1 piece price shown. See web or call for volume pricing.			
4"	6"	8"	12"
\$56.54	\$57.01	\$57.47	\$58.41
		\$59.82	\$61.21

**MMBX PLUG RIGHT ANGLE TO SMA FEMALE**



**Standard Flexible Cable Assemblies**

**RG178B/U Coax, 50 Ohm**

Part No. <a href="#">PE3W03154</a>	Cable Dia.	Attn. @ 1 GHz	Power @ 1 GHz
1 piece price shown. See web or call for volume pricing.			
4"	6"	8"	12"
\$61.93	\$62.08	\$62.25	\$62.56
		\$63.03	\$63.49

**RG316/U Coax, 50 Ohm**

Part No. <a href="#">PE3C4030</a>	Cable Dia.	Attn. @ 1 GHz	Power @ 1 GHz
1 piece price shown. See web or call for volume pricing.			
4"	6"	8"	12"
\$61.39	\$61.90	\$56.71	\$57.65
		\$59.06	\$60.45

**RG316-DS Coax, 50 Ohm**

Part No. <a href="#">PE3C4063</a>	Cable Dia.	Attn. @ 1 GHz	Power @ 1 GHz
1 piece price shown. See web or call for volume pricing.			
4"	6"	8"	12"
\$60.68	\$55.58	\$56.05	\$57.00
		\$58.40	\$59.83

**MMBX PLUG RIGHT ANGLE TO SMA FEMALE BULKHEAD**



SEE MOUNTING HOLE SECTION ON PAGE 369

**Standard Formable Cable Assemblies**

**PE-SR405FLJ Coax, 50 Ohm**

Part No. <a href="#">PE3C4067</a>	Cable Dia.	Attn. @ 1 GHz	Power @ 1 GHz
1 piece price shown. See web or call for volume pricing.			
4"	6"	8"	12"
\$54.47	\$50.78	\$52.03	\$54.55
		\$58.31	\$62.07

**Standard Flexible Cable Assemblies**

**RG174A/U Coax, 50 Ohm**

Part No. <a href="#">PE3C4035</a>	Cable Dia.	Attn. @ 1 GHz	Power @ 1 GHz
1 piece price shown. See web or call for volume pricing.			
4"	6"	8"	12"
\$51.14	\$51.20	\$51.27	\$51.42
		\$56.85	\$51.85

**RG178B/U Coax, 50 Ohm**

Part No. <a href="#">PE3C4807</a>	Cable Dia.	Attn. @ 1 GHz	Power @ 1 GHz
1 piece price shown. See web or call for volume pricing.			
12"	24"	36"	48"
\$68.62	\$69.64	\$70.67	\$71.70
		\$72.73	\$69.27

**RG316/U Coax, 50 Ohm**

Part No. <a href="#">PE3C4018</a>	Cable Dia.	Attn. @ 1 GHz	Power @ 1 GHz
1 piece price shown. See web or call for volume pricing.			
4"	6"	8"	12"
\$57.04	\$57.04	\$57.04	\$57.04
		\$58.47	\$59.92

**RG316-DS Coax, 50 Ohm**

Part No. <a href="#">PE3C4052</a>	Cable Dia.	Attn. @ 1 GHz	Power @ 1 GHz
1 piece price shown. See web or call for volume pricing.			
4"	6"	8"	12"
\$58.02	\$58.47	\$58.95	\$59.90
		\$61.30	\$62.72

**MMBX PLUG RIGHT ANGLE TO REVERSE POLARITY SMA FEMALE BULKHEAD**



SEE MOUNTING HOLE SECTION ON PAGE 369

**Standard Flexible Cable Assemblies**

**RG178B/U Coax, 50 Ohm**

Part No. <a href="#">PE3C3992</a>	Cable Dia.	Attn. @ 1 GHz	Power @ 1 GHz
1 piece price shown. See web or call for volume pricing.			
4"	6"	8"	12"
\$49.75	\$45.38	\$45.54	\$45.85
		\$46.32	\$46.79

**RG316-DS Coax, 50 Ohm**

Part No. <a href="#">PE3C4055</a>	Cable Dia.	Attn. @ 1 GHz	Power @ 1 GHz
1 piece price shown. See web or call for volume pricing.			
4"	6"	8"	12"
\$62.14	\$62.60	\$63.08	\$64.02
		\$65.43	\$66.85

**MMBX PLUG RIGHT ANGLE TO TNC FEMALE BULKHEAD**



SEE MOUNTING HOLE SECTION ON PAGE 369

**Standard Flexible Cable Assemblies**

**RG174A/U Coax, 50 Ohm**

Part No. <a href="#">PE3C4043</a>	Cable Dia.	Attn. @ 1 GHz	Power @ 1 GHz
1 piece price shown. See web or call for volume pricing.			
4"	6"	8"	12"
\$59.24	\$59.32	\$59.39	\$65.48
		\$65.77	\$59.95

**RG178B/U Coax, 50 Ohm**

Part No. <a href="#">PE3C3996</a>	Cable Dia.	Attn. @ 1 GHz	Power @ 1 GHz
1 piece price shown. See web or call for volume pricing.			
4"	6"	8"	12"
\$62.70	\$57.15	\$57.31	\$57.62
		\$58.09	\$58.56

**RG316/U Coax, 50 Ohm**

Part No. <a href="#">PE3C4026</a>	Cable Dia.	Attn. @ 1 GHz	Power @ 1 GHz
1 piece price shown. See web or call for volume pricing.			
4"	6"	8"	12"
\$60.03	\$60.50	\$60.97	\$61.91
		\$67.19	\$64.70

**RG316-DS Coax, 50 Ohm**

Part No. <a href="#">PE3C4059</a>	Cable Dia.	Attn. @ 1 GHz	Power @ 1 GHz
1 piece price shown. See web or call for volume pricing.			
4"	6"	8"	12"
\$59.67	\$60.14	\$60.62	\$61.55
		\$69.27	\$64.38

**N MALE TO N MALE**



**Standard Flexible Cable Assemblies**

**M17/60-RG142-27478 Coax, 50 Ohm**

Part No. <a href="#">PE3M0008</a>	Cable Dia.	Attn. @ 1 GHz	Power @ 1 GHz
1 piece price shown. See web or call for volume pricing.			
12"	18"	24"	30"
\$151.97	\$154.70	\$157.43	\$160.15
		\$162.88	\$168.34

**M17/84-RG223-0XDS2 Coax, 50 Ohm**

Part No. <a href="#">PE3M0036</a>	Cable Dia.	Attn. @ 1 GHz	Power @ 1 GHz
1 piece price shown. See web or call for volume pricing.			
12"	18"	24"	30"
\$156.28	\$161.15	\$166.03	\$170.91
		\$176.37	\$185.54

**M17/128-RG400-27478 Coax, 50 Ohm**

Part No. <a href="#">PE3M0064</a>	Cable Dia.	Attn. @ 1 GHz	Power @ 1 GHz
1 piece price shown. See web or call for volume pricing.			
12"	18"	24"	30"
\$153.46	\$156.93	\$160.40	\$163.87
		\$167.34	\$174.28

**N MALE TO N FEMALE**



**Standard Flexible Cable Assemblies**

**M17/60-RG142-27478 Coax, 50 Ohm**

\*Coax Performance at 1 GHz Notes: Cable assembly max frequency may be lower than connector or coax max frequency

Cable Assemblies See Our Website For Current Pricing & Real-Time Stock Availability!

For our complete selection of cable assemblies, please visit our website

Part No. <a href="#">PE3M0009</a>	Cable Dia.	Attn. @ 1 GHz	Power @ 1 GHz
1 piece price shown. See web or call for volume pricing.			
12"	18"	24"	30"
\$161.55	\$164.28	\$167.01	\$169.73
M17/84-RG223-0XDS2 Coax, 50 Ohm			
Cable Dia. Attn. @ 1 GHz Power @ 1 GHz			
1 piece price shown. See web or call for volume pricing.			
12"	18"	24"	30"
\$165.86	\$170.73	\$175.61	\$180.48
M17/128-RG400-27478 Coax, 50 Ohm			
Cable Dia. Attn. @ 1 GHz Power @ 1 GHz			
1 piece price shown. See web or call for volume pricing.			
12"	18"	24"	30"
\$163.04	\$166.51	\$169.98	\$173.45

Part No. <a href="#">PE3M0016</a>	Cable Dia.	Attn. @ 1 GHz	Power @ 1 GHz
1 piece price shown. See web or call for volume pricing.			
12"	18"	24"	30"
\$154.58	\$157.30	\$160.04	\$162.76
M17/84-RG223-0XDS2 Coax, 50 Ohm			
Cable Dia. Attn. @ 1 GHz Power @ 1 GHz			
1 piece price shown. See web or call for volume pricing.			
12"	18"	24"	30"
\$158.88	\$163.76	\$168.64	\$173.51
M17/128-RG400-27478 Coax, 50 Ohm			
Cable Dia. Attn. @ 1 GHz Power @ 1 GHz			
1 piece price shown. See web or call for volume pricing.			
12"	18"	24"	30"
\$156.07	\$159.54	\$163.01	\$166.48

**N MALE TO N FEMALE BULKHEAD**

SEE MOUNTING HOLE SECTION ON PAGE 369



**N MALE TO 4.1/9.5 MINI DIN MALE**



**Standard Flexible Cable Assemblies**

**Low PIM Corrugated Cable Assemblies**

Part No. <a href="#">PE3M0010</a>	Cable Dia.	Attn. @ 1 GHz	Power @ 1 GHz
1 piece price shown. See web or call for volume pricing.			
12"	18"	24"	30"
\$165.40	\$168.12	\$170.85	\$173.58
M17/84-RG223-0XDS2 Coax, 50 Ohm			
Cable Dia. Attn. @ 1 GHz Power @ 1 GHz			
1 piece price shown. See web or call for volume pricing.			
12"	18"	24"	30"
\$169.70	\$174.57	\$179.46	\$184.33

Part No. <a href="#">PE3C4140</a>	Cable Dia.	Attn. @ 1 GHz	Power @ 1 GHz
1 piece price shown. See web or call for volume pricing.			
12"	24"	36"	48"
\$90.05	\$95.63	\$101.21	\$106.79
SPP-250-LLPL Coax, 50 Ohm			
Cable Dia. Attn. @ 1 GHz Power @ 1 GHz			
1 piece price shown. See web or call for volume pricing.			
12"	24"	36"	48"
\$90.05	\$95.63	\$101.21	\$106.79

Part No. <a href="#">PE3M0038</a>	Cable Dia.	Attn. @ 1 GHz	Power @ 1 GHz
1 piece price shown. See web or call for volume pricing.			
12"	18"	24"	30"
\$169.70	\$174.57	\$179.46	\$184.33
M17/128-RG400-27478 Coax, 50 Ohm			
Cable Dia. Attn. @ 1 GHz Power @ 1 GHz			
1 piece price shown. See web or call for volume pricing.			
12"	18"	24"	30"
\$166.88	\$170.32	\$173.82	\$177.29

**N MALE TO 7/16 DIN MALE**



**Standard Flexible Cable Assemblies**

**Low Loss Formable Cable Assemblies**

Part No. <a href="#">PE3M0014</a>	Cable Dia.	Attn. @ 1 GHz	Power @ 1 GHz
1 piece price shown. See web or call for volume pricing.			
12"	18"	24"	30"
\$185.30	\$188.02	\$190.75	\$193.47
M17/84-RG223-0XDS2 Coax, 50 Ohm			
Cable Dia. Attn. @ 1 GHz Power @ 1 GHz			
1 piece price shown. See web or call for volume pricing.			
12"	18"	24"	30"
\$189.60	\$194.47	\$199.35	\$204.23

Part No. <a href="#">PE3C0143</a>	Cable Dia.	Attn. @ 1 GHz	Power @ 1 GHz
1 piece price shown. See web or call for volume pricing.			
12"	24"	36"	48"
\$79.18	\$81.47	\$83.74	\$86.02
LMR-SW396 Coax, 50 Ohm			
Cable Dia. Attn. @ 1 GHz Power @ 1 GHz			
1 piece price shown. See web or call for volume pricing.			
12"	24"	36"	48"
\$79.18	\$81.47	\$83.74	\$86.02

**N MALE TO SMA MALE**



**Standard Flexible Cable Assemblies**

Part No. <a href="#">PE3M0017</a>	Cable Dia.	Attn. @ 1 GHz	Power @ 1 GHz
1 piece price shown. See web or call for volume pricing.			
12"	18"	24"	30"
\$185.30	\$188.02	\$190.75	\$193.47
M17/84-RG223-0XDS2 Coax, 50 Ohm			
Cable Dia. Attn. @ 1 GHz Power @ 1 GHz			
1 piece price shown. See web or call for volume pricing.			
12"	18"	24"	30"
\$189.60	\$194.47	\$199.35	\$204.23

**Low Loss Flexible Cable Assemblies**

Part No. <a href="#">PE38436</a>	Cable Dia.	Attn. @ 1 GHz	Power @ 1 GHz
1 piece price shown. See web or call for volume pricing.			
36"	48"	60"	72"
\$121.97	\$127.85	\$133.73	\$137.59
PE-C600 Coax, 50 Ohm			
Cable Dia. Attn. @ 1 GHz Power @ 1 GHz			
1 piece price shown. See web or call for volume pricing.			
36"	48"	60"	72"
\$121.97	\$127.85	\$133.73	\$137.59

Part No. <a href="#">PE3M0042</a>	Cable Dia.	Attn. @ 1 GHz	Power @ 1 GHz
1 piece price shown. See web or call for volume pricing.			
12"	18"	24"	30"
\$189.60	\$194.47	\$199.35	\$204.23
M17/128-RG400-27478 Coax, 50 Ohm			
Cable Dia. Attn. @ 1 GHz Power @ 1 GHz			
1 piece price shown. See web or call for volume pricing.			
12"	18"	24"	30"
\$186.78	\$190.25	\$193.72	\$197.19

**Low Loss Flexible Cable Assemblies**

Part No. <a href="#">PE3W03803</a>	Cable Dia.	Attn. @ 1 GHz	Power @ 1 GHz
1 piece price shown. See web or call for volume pricing.			
12"	24"	36"	48"
\$85.27	\$86.61	\$87.95	\$89.29
LMR-400 Coax, 50 Ohm			
Cable Dia. Attn. @ 1 GHz Power @ 1 GHz			
1 piece price shown. See web or call for volume pricing.			
12"	24"	36"	48"
\$85.27	\$86.61	\$87.95	\$89.29

Part No. <a href="#">PE3M0070</a>	Cable Dia.	Attn. @ 1 GHz	Power @ 1 GHz
1 piece price shown. See web or call for volume pricing.			
12"	18"	24"	30"
\$186.78	\$190.25	\$193.72	\$197.19
M17/128-RG400-27478 Coax, 50 Ohm			
Cable Dia. Attn. @ 1 GHz Power @ 1 GHz			
1 piece price shown. See web or call for volume pricing.			
12"	18"	24"	30"
\$186.78	\$190.25	\$193.72	\$197.19

**Low PIM Formable Cable Assemblies**

Part No. <a href="#">PE3C2012</a>	Cable Dia.	Attn. @ 1 GHz	Power @ 1 GHz
1 piece price shown. See web or call for volume pricing.			
100CM	200CM	-	-
\$153.56	\$185.37	-	-
PE-SR401FLJ Low PIM Coax, 50 Ohm			
Cable Dia. Attn. @ 1 GHz Power @ 1 GHz			
1 piece price shown. See web or call for volume pricing.			
100CM	200CM	-	-
\$111.81	\$134.70	-	-

**N MALE TO SMA MALE RIGHT ANGLE**



**Standard Flexible Cable Assemblies**

Part No. <a href="#">PE3M0015</a>	Cable Dia.	Attn. @ 1 GHz	Power @ 1 GHz
1 piece price shown. See web or call for volume pricing.			
12"	18"	24"	30"
\$221.38	\$224.10	\$226.83	\$229.56
M17/84-RG223-0XDS2 Coax, 50 Ohm			
Cable Dia. Attn. @ 1 GHz Power @ 1 GHz			
1 piece price shown. See web or call for volume pricing.			
12"	18"	24"	30"
\$225.68	\$230.55	\$235.44	\$240.31

**Low PIM Corrugated Cable Assemblies**

Part No. <a href="#">PE3C2002</a>	Cable Dia.	Attn. @ 1 GHz	Power @ 1 GHz
1 piece price shown. See web or call for volume pricing.			
100CM	200CM	-	-
\$111.81	\$134.70	-	-
PE-SR402FLJ Low PIM Coax, 50 Ohm			
Cable Dia. Attn. @ 1 GHz Power @ 1 GHz			
1 piece price shown. See web or call for volume pricing.			
100CM	200CM	-	-
\$111.81	\$134.70	-	-

Part No. <a href="#">PE3M0043</a>	Cable Dia.	Attn. @ 1 GHz	Power @ 1 GHz
1 piece price shown. See web or call for volume pricing.			
12"	18"	24"	30"
\$225.68	\$230.55	\$235.44	\$240.31
M17/128-RG400-27478 Coax, 50 Ohm			
Cable Dia. Attn. @ 1 GHz Power @ 1 GHz			
1 piece price shown. See web or call for volume pricing.			
12"	18"	24"	30"
\$222.87	\$226.33	\$229.81	\$233.27

**Low PIM Corrugated Cable Assemblies**

Part No. <a href="#">PE3C4132</a>	Cable Dia.	Attn. @ 1 GHz	Power @ 1 GHz
1 piece price shown. See web or call for volume pricing.			
12"	24"	36"	48"
\$92.38	\$97.96	\$103.54	\$109.12
SPP-250-LLPL Coax, 50 Ohm			
Cable Dia. Attn. @ 1 GHz Power @ 1 GHz			
1 piece price shown. See web or call for volume pricing.			
12"	24"	36"	48"
\$92.38	\$97.96	\$103.54	\$109.12

Part No. <a href="#">PE3M0071</a>	Cable Dia.	Attn. @ 1 GHz	Power @ 1 GHz
1 piece price shown. See web or call for volume pricing.			
12"	18"	24"	30"
\$222.87	\$226.33	\$229.81	\$233.27

**Standard Formable Cable Assemblies**

Part No. <a href="#">PE36178</a>	Cable Dia.	Attn. @ 1 GHz	Power @ 1 GHz
1 piece price shown. See web or call for volume pricing.			
12"	24"	36"	48"
\$214.22	\$229.17	\$244.10	\$259.05
PE-SR401FL Coax, 50 Ohm			
Cable Dia. Attn. @ 1 GHz Power @ 1 GHz			
1 piece price shown. See web or call for volume pricing.			
12"	24"	36"	48"
\$214.22	\$229.17	\$244.10	\$259.05

**N MALE TO TNC MALE**



**Standard Flexible Cable Assemblies**

Part No. <a href="#">PE3207</a>	Cable Dia.	Attn. @ 1 GHz	Power @ 1 GHz
1 piece price shown. See web or call for volume pricing.			
12"	24"	36"	48"
\$143.42	\$144.16	\$144.90	\$145.63
RG142B/U Coax, 50 Ohm			
Cable Dia. Attn. @ 1 GHz Power @ 1 GHz			
1 piece price shown. See web or call for volume pricing.			
12"	24"	36"	48"
\$143.42	\$144.16	\$144.90	\$145.63

**Standard Flexible Cable Assemblies**

Part No. <a href="#">PE35284</a>	Cable Dia.	Attn. @ 1 GHz	Power @ 1 GHz
1 piece price shown. See web or call for volume pricing.			
12"	24"	36"	48"
\$163.59	\$166.42	\$179.55	\$172.09
RG58C/U Coax, 50 Ohm			
Cable Dia. Attn. @ 1 GHz Power @ 1 GHz			
1 piece price shown. See web or call for volume pricing.			
12"	24"	36"	48"
\$143.42	\$144.16	\$144.90	\$145.63

**Standard Flexible Cable Assemblies**

Part No. <a href="#">PE3207</a>	Cable Dia.	Attn. @ 1 GHz	Power @ 1 GHz
1 piece price shown. See web or call for volume pricing.			
12"	24"	36"	48"
\$143.42	\$144.16	\$144.90	\$145.63
RG142B/U Coax, 50 Ohm			
Cable Dia. Attn. @ 1 GHz Power @ 1 GHz			
1 piece price shown. See web or call for volume pricing.			
12"	24"	36"	48"
\$143.42	\$144.16	\$144.90	\$145.63

Cable Assemblies

See Our Website For Current Pricing & Real-Time Stock Availability!

Continued on Next Page

For Custom Lengths, Metric Lengths or Special Configurations, Please call (949) 261-1920



Technical Support  
+1 (949) 261-1920



Same-Day Shipping,  
Even Custom Cable Assemblies

For our complete selection of cable assemblies, please visit our website

Cable Assemblies  
See Our Website For Current Pricing & Real-Time Stock Availability!

Part No.	Cable Dia.				Attn. @ 1 GHz	Power @ 1 GHz
<b>PE3216</b>	0.195" dia.				13 dB/100ft	W
1 piece price shown. See web or call for volume pricing.	12"	24"	36"	48"	60"	72"
	\$77.63	\$83.37	\$94.45	\$94.83	\$100.56	\$106.29
<b>RG213/U Coax, 50 Ohm</b>						
<b>PE34098</b>	0.405" dia.				8 dB/100ft	190 W
1 piece price shown. See web or call for volume pricing.	12"	24"	36"	48"	60"	72"
	\$162.45	\$164.10	\$165.77	\$167.42	\$169.09	\$181.31
<b>RG214/U Coax, 50 Ohm</b>						
<b>PE3218</b>	0.425" dia.				7 dB/100ft	170 W
1 piece price shown. See web or call for volume pricing.	12"	24"	36"	48"	60"	72"
	\$166.66	\$173.97	\$188.88	\$197.12	\$205.05	\$203.28
<b>RG217/U Coax, 50 Ohm</b>						
<b>PE36170</b>	0.545" dia.				6 dB/100ft	260 W
1 piece price shown. See web or call for volume pricing.	12"	24"	36"	48"	60"	72"
	\$197.36	\$201.79	\$206.25	\$210.69	\$215.11	\$219.56
<b>RG218/U Coax, 50 Ohm</b>						
<b>PE36172</b>	0.870" dia.				4 dB/100ft	560 W
1 piece price shown. See web or call for volume pricing.	12"	24"	36"	48"	60"	72"
	\$273.88	\$285.04	\$296.14	\$327.59	\$318.47	\$329.63
<b>RG223/U Coax, 50 Ohm</b>						
<b>PE33144</b>	0.209" dia.				13 dB/100ft	50 W
1 piece price shown. See web or call for volume pricing.	12"	24"	36"	48"	60"	72"
	\$74.84	\$77.74	\$88.63	\$83.54	\$86.43	\$89.33
<b>RG393/U Coax, 50 Ohm</b>						
<b>PE34357</b>	0.390" dia.				9 dB/100ft	1700 W
1 piece price shown. See web or call for volume pricing.	12"	24"	36"	48"	60"	72"
	\$175.36	\$190.83	\$206.30	\$221.76	\$252.78	\$252.70
<b>RG400/U Coax, 50 Ohm</b>						
<b>PE34359</b>	0.195" dia.				15 dB/100ft	650 W
1 piece price shown. See web or call for volume pricing.	12"	24"	36"	48"	60"	72"
	\$85.53	\$92.49	\$99.46	\$106.44	\$113.41	\$120.37
<b>PE-FF430 Coax, 50 Ohm</b>						
<b>PE3C4000</b>	0.430" dia.				dB/100ft	W
1 piece price shown. See web or call for volume pricing.	60"	144"	-	-	-	-
	\$806.13	\$794.81	-	-	-	-
<b>Standard Semi-Rigid Cable Assemblies</b>						
<b>RG402/U Coax, 50 Ohm</b>						
<b>PE35963</b>	" dia.				12 dB/100ft	650 W
1 piece price shown. See web or call for volume pricing.	12"	24"	36"	48"	60"	72"
	\$189.31	\$196.38	\$203.48	\$210.54	\$217.64	\$224.73
<b>N MALE TO 7/16 DIN MALE RIGHT ANGLE</b>						
<b>Low PIM Corrugated Cable Assemblies</b>						
<b>SPP-250-LLPL Coax, 50 Ohm</b>						
<b>PE3C4136</b>	0.280" dia.				dB/100ft	W
1 piece price shown. See web or call for volume pricing.	12"	24"	36"	48"	60"	72"
	\$104.07	\$109.65	\$115.23	\$120.80	\$126.38	\$107.64
<b>N MALE TO 7/16 DIN FEMALE</b>						
<b>Low PIM Formable Cable Assemblies</b>						
<b>PE-SR401FLJ Low PIM Coax, 50 Ohm</b>						
<b>PE3C2014</b>	0.276" dia.				dB/100ft	W
1 piece price shown. See web or call for volume pricing.	100CM	200CM	-	-	-	-
	\$147.00	\$175.39	-	-	-	-
<b>PE-SR402FLJ Low PIM Coax, 50 Ohm</b>						
<b>PE3C2005</b>	0.161" dia.				dB/100ft	W
1 piece price shown. See web or call for volume pricing.	100CM	200CM	-	-	-	-
	\$119.90	\$142.77	-	-	-	-
<b>Standard Flexible Cable Assemblies</b>						
<b>PE-FF430 Coax, 50 Ohm</b>						
<b>PE3C4001</b>	0.430" dia.				dB/100ft	W
1 piece price shown. See web or call for volume pricing.	60"	144"	-	-	-	-
	\$856.69	\$1,068.06	-	-	-	-

<b>N MALE TO BNC MALE</b>						
<b>Low Loss Flexible Cable Assemblies</b>						
<b>PE-C195 Coax, 50 Ohm</b>						
<b>PE36065</b>	0.195" dia.				11 dB/100ft	150 W
1 piece price shown. See web or call for volume pricing.	12"	24"	36"	48"	60"	-
	\$36.29	\$34.32	\$37.85	\$35.74	\$39.47	-
<b>PE-C240 Coax, 50 Ohm</b>						
<b>PE35269</b>	0.240" dia.				9 dB/100ft	250 W
1 piece price shown. See web or call for volume pricing.	12"	24"	36"	48"	60"	-
	\$51.42	\$52.55	\$51.40	\$54.89	\$56.99	-
<b>LMR-240-UF Coax, 50 Ohm</b>						
<b>PE3C2404</b>	0.240" dia.				50CM	W
1 piece price shown. See web or call for volume pricing.	12"	24"	36"	48"	60"	50CM
	\$36.84	\$38.16	\$39.48	\$40.80	\$42.12	\$37.68
<b>Standard Flexible Cable Assemblies</b>						
<b>RG8A/U Coax, 50 Ohm</b>						
<b>PE3252</b>	0.405" dia.				8 dB/100ft	190 W
1 piece price shown. See web or call for volume pricing.	12"	24"	36"	48"	60"	72"
	\$65.43	\$68.20	\$75.49	\$73.65	\$81.87	\$79.12
<b>RG58C/U Coax, 50 Ohm</b>						
<b>PE3042</b>	0.195" dia.				20 dB/100ft	44 W
1 piece price shown. See web or call for volume pricing.	12"	24"	36"	48"	60"	72"
	\$40.46	\$41.20	\$41.93	\$42.67	\$43.41	\$44.15
<b>RG142B/U Coax, 50 Ohm</b>						
<b>PE3W00140</b>	0.195" dia.				13 dB/100ft	650 W
1 piece price shown. See web or call for volume pricing.	12"	24"	36"	48"	60"	50CM
	\$41.14	\$47.05	\$52.95	\$58.85	\$64.75	\$44.93
<b>RG174A/U Coax, 50 Ohm</b>						
<b>PE3C3378</b>	0.110" dia.				32 dB/100ft	17 W
1 piece price shown. See web or call for volume pricing.	6"	12"	18"	24"	36"	48"
	\$41.20	\$41.44	\$41.66	\$46.15	\$42.31	\$47.35
<b>RG188A/U Coax, 50 Ohm</b>						
<b>PE3C3379</b>	0.110" dia.				26 dB/100ft	160 W
1 piece price shown. See web or call for volume pricing.	12"	24"	36"	48"	60"	72"
	\$43.05	\$45.13	\$47.21	\$49.23	\$51.32	\$53.33
<b>RG213/U Coax, 50 Ohm</b>						
<b>PE3750</b>	0.405" dia.				8 dB/100ft	190 W
1 piece price shown. See web or call for volume pricing.	12"	24"	36"	48"	60"	72"
	\$73.68	\$75.46	\$77.25	\$74.49	\$76.16	\$82.79
<b>RG214/U Coax, 50 Ohm</b>						
<b>PE3097</b>	0.425" dia.				7 dB/100ft	170 W
1 piece price shown. See web or call for volume pricing.	12"	24"	36"	48"	60"	72"
	\$78.90	\$86.68	\$94.46	\$102.69	\$103.74	\$118.56
<b>RG223/U Coax, 50 Ohm</b>						
<b>PE3476</b>	0.210" dia.				13 dB/100ft	53 W
1 piece price shown. See web or call for volume pricing.	12"	24"	36"	48"	60"	72"
	\$39.98	\$43.10	\$46.20	\$49.50	\$52.68	\$55.86
<b>RG316/U Coax, 50 Ohm</b>						
<b>PE3C3380</b>	0.102" dia.				38 dB/100ft	160 W
1 piece price shown. See web or call for volume pricing.	12"	24"	36"	48"	60"	72"
	\$50.27	\$53.39	\$56.51	\$56.09	\$58.97	\$66.19
<b>RG393/U Coax, 50 Ohm</b>						
<b>PE3254</b>	0.390" dia.				8 dB/100ft	1700 W
1 piece price shown. See web or call for volume pricing.	12"	24"	36"	48"	60"	72"
	\$81.70	\$92.69	\$108.29	\$123.90	\$139.50	\$165.32
<b>RG400/U Coax, 50 Ohm</b>						
<b>PE3874</b>	0.195" dia.				15 dB/100ft	650 W
1 piece price shown. See web or call for volume pricing.	12"	24"	36"	48"	60"	72"
	\$54.14	\$61.54	\$68.93	\$76.76	\$84.29	\$91.84
<b>RG55B/U Coax, 53 Ohm</b>						
<b>PE3477</b>	0.202" dia.				17 dB/100ft	53 W
1 piece price shown. See web or call for volume pricing.	12"	24"	36"	48"	60"	72"
	\$38.39	\$40.64	\$42.88	\$48.61	\$47.36	\$49.60

\*Coax Performance at 1 GHz Notes: Cable assembly max frequency may be lower than connector or coax max frequency



For our complete selection of cable assemblies, please visit our website

Cable Assemblies

See Our Website For Current Pricing & Real-Time Stock Availability!

N MALE TO BNC FEMALE BULKHEAD						
SEE MOUNTING HOLE SECTION ON PAGE 369						
Standard Flexible Cable Assemblies						
RG400/U Coax, 50 Ohm						
Part No.	Cable Dia.			Attn. @ 1 GHz	Power @ 1 GHz	
1 piece price shown. See web or call for volume pricing.	0.195" dia.			15 dB/100ft	650 W	
12"	24"	36"	48"	60"	-	Custom Len.
\$65.84	\$73.23	\$80.63	\$88.45	\$95.99	-	See Web
N MALE TO C FEMALE						
Standard Flexible Cable Assemblies						
RG142B/U Coax, 50 Ohm						
Part No.	Cable Dia.			Attn. @ 1 GHz	Power @ 1 GHz	
1 piece price shown. See web or call for volume pricing.	0.195" dia.			13 dB/100ft	W	
12"	24"	36"	48"	60"	50CM	Custom Len.
\$113.25	\$119.14	\$125.04	\$130.95	\$136.85	\$117.02	See Web
N MALE TO MINI UHF MALE						
Standard Flexible Cable Assemblies						
RG58C/U Coax, 50 Ohm						
Part No.	Cable Dia.			Attn. @ 1 GHz	Power @ 1 GHz	
1 piece price shown. See web or call for volume pricing.	0.195" dia.			20 dB/100ft	44 W	
12"	24"	36"	48"	60"	72"	Custom Len.
\$40.87	\$44.96	\$45.77	\$43.09	\$47.46	\$44.55	See Web
RG142B/U Coax, 50 Ohm						
Part No.	Cable Dia.			Attn. @ 1 GHz	Power @ 1 GHz	
1 piece price shown. See web or call for volume pricing.	0.195" dia.			13 dB/100ft	W	
12"	24"	36"	48"	60"	72"	Custom Len.
\$43.06	\$49.13	\$55.21	\$61.64	\$67.84	\$74.04	See Web
RG223/U Coax, 50 Ohm						
Part No.	Cable Dia.			Attn. @ 1 GHz	Power @ 1 GHz	
1 piece price shown. See web or call for volume pricing.	0.209" dia.			13 dB/100ft	50 W	
12"	24"	36"	48"	60"	72"	Custom Len.
\$35.67	\$38.56	\$41.48	\$44.44	\$50.51	\$50.26	See Web
RG303/U Coax, 50 Ohm						
Part No.	Cable Dia.			Attn. @ 1 GHz	Power @ 1 GHz	
1 piece price shown. See web or call for volume pricing.	0.170" dia.			14 dB/100ft	650 W	
12"	24"	36"	48"	60"	50CM	Custom Len.
\$35.14	\$42.01	\$48.88	\$55.76	\$62.64	\$39.54	See Web
RG400/U Coax, 50 Ohm						
Part No.	Cable Dia.			Attn. @ 1 GHz	Power @ 1 GHz	
1 piece price shown. See web or call for volume pricing.	0.195" dia.			15 dB/100ft	600 W	
12"	24"	36"	48"	60"	72"	Custom Len.
\$51.42	\$55.48	\$62.45	\$69.42	\$76.39	\$83.36	See Web
N MALE TO N MALE						
Flexible Cable Assemblies						
PE-C500 Coax, 50 Ohm						
Part No.	Cable Dia.			Attn. @ 1 GHz	Power @ 1 GHz	
1 piece price shown. See web or call for volume pricing.	0.500" dia.			4 dB/100ft	720 W	
12"	24"	36"	48"	60"	-	Custom Len.
\$89.81	\$93.82	\$97.85	\$101.87	\$105.88	-	See Web
Corrugated Cable Assemblies						
PE-1/4SFHC Coax, 50 Ohm						
Part No.	Cable Dia.			Attn. @ 1 GHz	Power @ 1 GHz	
1 piece price shown. See web or call for volume pricing.	0.303" dia.			6 dB/100ft	W	
12"	24"	36"	48"	60"	-	Custom Len.
\$132.41	\$135.53	\$138.64	\$141.94	\$145.11	-	See Web
SPP-250-LLPL Coax, 50 Ohm						
Part No.	Cable Dia.			Attn. @ 1 GHz	Power @ 1 GHz	
1 piece price shown. See web or call for volume pricing.	0.280" dia.			6 dB/100ft	650 W	
12"	24"	36"	48"	60"	50CM	Custom Len.
\$87.70	\$93.28	\$98.86	\$104.44	\$110.02	\$91.28	See Web
Precision Formable Cable Assemblies						
PE-SR402FLJ Coax, 50 Ohm						
Part No.	Cable Dia.			Attn. @ 1 GHz	Power @ 1 GHz	
1 piece price shown. See web or call for volume pricing.	0.161" dia.			12 dB/100ft	450 W	
6"	9"	12"	18"	24"	-	Custom Len.
\$52.96	\$55.18	\$52.96	\$56.74	\$65.51	-	See Web
PE-80TEST Coax, 50 Ohm						
Part No.	Cable Dia.			Attn. @ 1 GHz	Power @ 1 GHz	
1 piece price shown. See web or call for volume pricing.	0.195" dia.			dB/100ft	W	
24"	48"	72"	-	-	-	Custom Len.
\$340.60	\$426.34	\$512.09	-	-	-	See Web

PE-90TEST Coax, 50 Ohm						
Part No.	Cable Dia.			Attn. @ 1 GHz	Power @ 1 GHz	
1 piece price shown. See web or call for volume pricing.	0.151" dia.			dB/100ft	W	
24"	48"	72"	-	-	-	Custom Len.
\$278.24	\$356.19	\$434.15	-	-	-	See Web
Low Loss Formable Cable Assemblies						
LMR-SW396 Coax, 50 Ohm						
Part No.	Cable Dia.			Attn. @ 1 GHz	Power @ 1 GHz	
1 piece price shown. See web or call for volume pricing.	0.450" dia.			3 dB/100ft	W	
12"	24"	36"	48"	60"	-	Custom Len.
\$79.18	\$81.47	\$86.67	\$86.02	\$88.32	-	See Web
LMR-SW540 Coax, 50 Ohm						
Part No.	Cable Dia.			Attn. @ 1 GHz	Power @ 1 GHz	
1 piece price shown. See web or call for volume pricing.	" dia.			2 dB/100ft	W	
12"	24"	36"	48"	60"	-	Custom Len.
\$84.20	\$86.81	\$94.48	\$92.02	\$94.64	-	See Web
Low Loss Flexible Cable Assemblies						
PE-C195 Coax, 50 Ohm						
Part No.	Cable Dia.			Attn. @ 1 GHz	Power @ 1 GHz	
1 piece price shown. See web or call for volume pricing.	0.195" dia.			11 dB/100ft	150 W	
36"	48"	60"	72"	120"	-	Custom Len.
\$32.27	\$33.10	\$33.90	\$34.69	\$37.88	-	See Web
PE-C200 Coax, 50 Ohm						
Part No.	Cable Dia.			Attn. @ 1 GHz	Power @ 1 GHz	
1 piece price shown. See web or call for volume pricing.	0.195" dia.			11 dB/100ft	170 W	
12"	24"	36"	48"	60"	-	Custom Len.
\$45.65	\$47.25	\$51.45	\$55.65	\$59.86	-	See Web
PE-C240 Coax, 50 Ohm						
Part No.	Cable Dia.			Attn. @ 1 GHz	Power @ 1 GHz	
1 piece price shown. See web or call for volume pricing.	0.240" dia.			9 dB/100ft	250 W	
36"	48"	60"	72"	120"	-	Custom Len.
\$49.59	\$50.80	\$48.78	\$53.10	\$62.14	-	See Web
PE-C300 Coax, 50 Ohm						
Part No.	Cable Dia.			Attn. @ 1 GHz	Power @ 1 GHz	
1 piece price shown. See web or call for volume pricing.	0.300" dia.			6 dB/100ft	350 W	
12"	24"	36"	48"	60"	-	Custom Len.
\$68.47	\$67.43	\$75.02	\$73.09	\$75.93	-	See Web
PE-C400 Coax, 50 Ohm						
Part No.	Cable Dia.			Attn. @ 1 GHz	Power @ 1 GHz	
1 piece price shown. See web or call for volume pricing.	0.400" dia.			4 dB/100ft	550 W	
12"	24"	36"	48"	60"	-	Custom Len.
\$58.64	\$62.48	\$63.96	\$65.54	\$68.92	-	See Web
PE-C400 Coax, 50 Ohm						
Part No.	Cable Dia.			Attn. @ 1 GHz	Power @ 1 GHz	
1 piece price shown. See web or call for volume pricing.	0.400" dia.			4 dB/100ft	550 W	
36"	48"	60"	72"	120"	-	Custom Len.
\$65.77	\$67.35	\$64.51	\$65.83	-	-	See Web
PE-C600 Coax, 50 Ohm						
Part No.	Cable Dia.			Attn. @ 1 GHz	Power @ 1 GHz	
1 piece price shown. See web or call for volume pricing.	0.590" dia.			3 dB/100ft	900 W	
36"	48"	60"	72"	120"	-	Custom Len.
\$104.56	\$107.04	\$109.51	\$111.99	\$129.65	-	See Web
LMR-240 Coax, 50 Ohm						
Part No.	Cable Dia.			Attn. @ 1 GHz	Power @ 1 GHz	
1 piece price shown. See web or call for volume pricing.	0.240" dia.			8 dB/100ft	W	
12"	24"	36"	48"	60"	-	Custom Len.
\$41.27	\$42.24	\$43.21	\$44.24	\$45.24	-	See Web
LMR-400 Coax, 50 Ohm						
Part No.	Cable Dia.			Attn. @ 1 GHz	Power @ 1 GHz	
1 piece price shown. See web or call for volume pricing.	0.240" dia.			8 dB/100ft	W	
12"	24"	36"	48"	60"	-	Custom Len.
\$54.43	\$55.28	\$56.13	\$56.98	\$57.83	-	See Web
LMR-400 Coax, 50 Ohm						
Part No.	Cable Dia.			Attn. @ 1 GHz	Power @ 1 GHz	
1 piece price shown. See web or call for volume pricing.	0.240" dia.			8 dB/100ft	W	
12"	24"	36"	48"	60"	-	Custom Len.
\$45.71	\$46.68	\$47.66	\$48.69	\$49.67	-	See Web
LMR-400 Coax, 50 Ohm						
Part No.	Cable Dia.			Attn. @ 1 GHz	Power @ 1 GHz	
1 piece price shown. See web or call for volume pricing.	0.405" dia.			4 dB/100ft	W	
12"	24"	36"	48"	60"	-	Custom Len.
\$48.43	\$49.81	\$51.19	\$52.66	\$54.06	-	See Web
LMR-400 Coax, 50 Ohm						
Part No.	Cable Dia.			Attn. @ 1 GHz	Power @ 1 GHz	
1 piece price shown. See web or call for volume pricing.	0.405" dia.			4 dB/100ft	W	
12"	24"	36"	48"	60"	-	Custom Len.
\$49.66	\$51.05	\$52.43	\$53.88	\$55.30	-	See Web
LMR-400 Coax, 50 Ohm						
Part No.	Cable Dia.			Attn. @ 1 GHz	Power @ 1 GHz	
1 piece price shown. See web or call for volume pricing.	0.405" dia.			4 dB/100ft	W	
12"	24"	36"	48"	60"	-	Custom Len.
\$80.66	\$82.03	\$83.41	\$84.88	\$86.28	-	See Web
LMR-400-UF Coax, 50 Ohm						
Part No.	Cable Dia.			Attn. @ 1 GHz	Power @ 1 GHz	
1 piece price shown. See web or call for volume pricing.	0.405" dia.			5 dB/100ft	W	
12"	18"	24"	36"	48"	60"	Custom Len.
\$48.30	\$49.56	\$50.83	\$53.36	\$55.89	\$58.42	See Web
LMR-600 Coax, 50 Ohm						

Continued on Next Page

For Custom Lengths, Metric Lengths or Special Configurations, Please call (949) 261-1920



Technical Support  
+1 (949) 261-1920



Same-Day Shipping,  
Even Custom Cable Assemblies

# For our complete selection of cable assemblies, please visit our website

Cable Assemblies  
See Our Website For Current Pricing & Real-Time Stock Availability!

Part No.	Cable Dia.	Attn. @ 1 GHz	Power @ 1 GHz
<b>Part No. PE3C0048</b>			
1 piece price shown. See web or call for volume pricing.			
12"	24"	36"	48"
\$142.62	\$145.46	\$140.21	\$151.30
		\$145.88	
			See Web
<b>Part No. PE3C0062</b>			
1 piece price shown. See web or call for volume pricing.			
12"	24"	36"	48"
\$131.07	\$141.77	\$144.61	\$147.61
		\$150.50	
			See Web
<b>Part No. PE3C0110</b>			
1 piece price shown. See web or call for volume pricing.			
12"	24"	36"	48"
\$106.89	\$116.14	\$112.57	\$115.39
		\$124.87	
			See Web
<b>Part No. PE3C0112</b>			
1 piece price shown. See web or call for volume pricing.			
12"	24"	36"	48"
\$78.25	\$76.66	\$79.49	\$82.32
		\$85.16	
			See Web
<b>LMR-195 Coax, 50 Ohm</b>			
<b>Part No. PE3C0060</b>			
1 piece price shown. See web or call for volume pricing.			
12"	24"	36"	48"
\$41.34	\$44.57	\$42.84	\$43.59
		\$46.88	
			See Web
<b>Part No. PE3C0061</b>			
1 piece price shown. See web or call for volume pricing.			
12"	24"	36"	48"
\$40.17	\$43.33	\$44.07	\$42.41
		\$45.63	
			See Web
<b>Part No. PE3C0118</b>			
1 piece price shown. See web or call for volume pricing.			
12"	24"	36"	48"
\$47.37	\$48.12	\$46.18	\$49.66
		\$50.42	
			See Web
<b>PE-P142LL Coax, 50 Ohm</b>			
<b>Part No. PE3C0231</b>			
1 piece price shown. See web or call for volume pricing.			
24"	36"	48"	60"
\$332.34	\$409.35	\$420.82	\$453.08
		\$472.35	\$718.69
			See Web
<b>Part No. PE343</b>			
1 piece price shown. See web or call for volume pricing.			
12"	24"	36"	48"
\$120.21	\$136.44	\$152.68	\$168.92
		\$185.15	\$130.61
			See Web
<b>PE-SF200LL Coax, 50 Ohm</b>			
<b>Part No. PE3TC1102</b>			
1 piece price shown. See web or call for volume pricing.			
24"	36"	48"	100CM
\$77.60	\$88.86	\$100.12	\$92.01
		\$128.96	
			See Web
<b>PE-P142LL-27478 Coax, 50 Ohm</b>			
<b>Part No. PE3M0174</b>			
1 piece price shown. See web or call for volume pricing.			
12"	18"	24"	36"
\$370.05	\$378.53	\$387.01	\$403.96
		\$420.92	\$437.88
			See Web
<b>PE-P160LL-27478 Coax, 50 Ohm</b>			
<b>Part No. PE3M0219</b>			
1 piece price shown. See web or call for volume pricing.			
8"	12"	18"	24"
\$340.63	\$345.53	\$352.89	\$360.23
		\$367.59	\$374.93
			See Web
<b>PE-P300LL-27478 Coax, 50 Ohm</b>			
<b>Part No. PE3M0247</b>			
1 piece price shown. See web or call for volume pricing.			
12"	18"	24"	36"
\$418.06	\$432.21	\$446.36	\$474.67
		\$502.97	\$531.27
			See Web
<b>PE-P160LL Coax, 50 Ohm</b>			
<b>Part No. PE3C5255</b>			
1 piece price shown. See web or call for volume pricing.			
12"	24"	36"	48"
\$205.44	\$226.16	\$246.87	\$267.58
		\$288.29	\$218.71
			See Web
<b>Low PIM Formable Cable Assemblies</b>			
<b>PE-SR401FLJ Low PIM Coax, 50 Ohm</b>			
<b>Part No. PE3C2011</b>			
1 piece price shown. See web or call for volume pricing.			
100CM	200CM	-	-
\$109.93	\$141.71	-	-
		-	-
		-	See Web
<b>PE-SR402FLJ Low PIM Coax, 50 Ohm</b>			
<b>Part No. PE3C2000</b>			
1 piece price shown. See web or call for volume pricing.			
100CM	200CM	-	-
\$79.93	\$91.81	-	-
		-	-
		-	See Web
<b>Low Loss Test Flexible Cable Assemblies</b>			
<b>PE-P300LL Coax, 50 Ohm</b>			
<b>Part No. PE330</b>			
1 piece price shown. See web or call for volume pricing.			
12"	24"	36"	48"
\$270.12	\$296.06	\$322.01	\$347.93
		\$373.87	\$286.74
			See Web
<b>Standard Formable Cable Assemblies</b>			
<b>PE-SR401FL Coax, 50 Ohm</b>			

Part No.	Cable Dia.	Attn. @ 1 GHz	Power @ 1 GHz
<b>Part No. PE34149</b>			
1 piece price shown. See web or call for volume pricing.			
6"	12"	18"	24"
\$132.92	\$140.90	\$140.63	\$157.22
		\$173.55	\$190.83
			See Web
<b>PE-SR402FL Coax, 50 Ohm</b>			
<b>Part No. PE39451</b>			
1 piece price shown. See web or call for volume pricing.			
6"	9"	12"	18"
\$62.61	\$53.17	\$53.17	\$56.94
		\$60.71	
			See Web
<b>Part No. PE3472</b>			
1 piece price shown. See web or call for volume pricing.			
6"	12"	18"	24"
\$83.37	\$87.30	\$91.33	\$95.37
		\$97.43	\$104.97
			See Web
<b>PE-SR405FL Coax, 50 Ohm</b>			
<b>Part No. PE3963</b>			
1 piece price shown. See web or call for volume pricing.			
6"	12"	18"	24"
\$111.80	\$111.80	\$117.15	\$122.50
		\$133.19	\$143.88
			See Web
<b>Standard Flexible Cable Assemblies</b>			
<b>RG8A/U Coax, 50 Ohm</b>			
<b>Part No. PE3570</b>			
1 piece price shown. See web or call for volume pricing.			
12"	24"	36"	48"
\$61.73	\$68.50	\$71.58	\$74.83
		\$77.96	\$81.08
			See Web
<b>RG8X Coax, 50 Ohm</b>			
<b>Part No. PE33720</b>			
1 piece price shown. See web or call for volume pricing.			
12"	24"	36"	48"
\$73.01	\$71.93	\$74.97	\$83.81
		\$81.09	
			See Web
<b>RG58C/U Coax, 50 Ohm</b>			
<b>Part No. PE3441</b>			
1 piece price shown. See web or call for volume pricing.			
12"	24"	36"	48"
\$47.51	\$48.32	\$49.13	\$50.00
		\$50.83	\$51.66
			See Web
<b>RG141A/U Coax, 50 Ohm</b>			
<b>Part No. PE36589</b>			
1 piece price shown. See web or call for volume pricing.			
12"	24"	36"	48"
\$60.92	\$71.47	\$78.37	\$85.69
		\$92.72	
			See Web
<b>RG142B/U Coax, 50 Ohm</b>			
<b>Part No. PE3455</b>			
1 piece price shown. See web or call for volume pricing.			
6"	12"	18"	24"
\$47.30	\$50.25	\$53.28	\$56.32
		\$57.37	\$62.40
			See Web
<b>RG174A/U Coax, 50 Ohm</b>			
<b>Part No. PE36273</b>			
1 piece price shown. See web or call for volume pricing.			
12"	24"	36"	48"
\$50.85	\$55.49	\$51.72	\$56.69
		\$57.27	
			See Web
<b>RG178B/U Coax, 50 Ohm</b>			
<b>Part No. PE33527</b>			
1 piece price shown. See web or call for volume pricing.			
12"	24"	36"	48"
\$76.56	\$77.62	\$74.15	\$75.10
		\$76.07	\$77.01
			See Web
<b>RG188A/U Coax, 50 Ohm</b>			
<b>Part No. PE33525</b>			
1 piece price shown. See web or call for volume pricing.			
12"	24"	36"	48"
\$56.54	\$58.76	\$60.98	\$63.20
		\$65.42	\$67.64
			See Web
<b>RG213/U Coax, 50 Ohm</b>			
<b>Part No. PE3496</b>			
1 piece price shown. See web or call for volume pricing.			
12"	24"	36"	48"
\$63.09	\$64.88	\$66.66	\$68.55
		\$70.37	\$72.19
			See Web
<b>RG214/U Coax, 50 Ohm</b>			
<b>Part No. PE3062</b>			
1 piece price shown. See web or call for volume pricing.			
12"	24"	36"	48"
\$65.77	\$73.55	\$81.33	\$89.56
		\$97.50	\$105.43
			See Web
<b>RG217/U Coax, 50 Ohm</b>			
<b>Part No. PE3997</b>			
1 piece price shown. See web or call for volume pricing.			
12"	24"	36"	48"
\$98.99	\$103.71	\$108.43	\$113.42
		\$118.23	\$115.50
			See Web
<b>RG218/U Coax, 50 Ohm</b>			
<b>Part No. PE33236</b>			
1 piece price shown. See web or call for volume pricing.			
12"	24"	36"	48"
\$232.35	\$258.48	\$255.34	\$283.57
		\$278.34	\$308.43
			See Web
<b>RG223/U Coax, 50 Ohm</b>			
<b>Part No. PE3W00417</b>			
1 piece price shown. See web or call for volume pricing.			
12"	24"	36"	48"
\$47.35	\$60.45	\$63.69	\$66.93
		\$70.17	\$59.27
			See Web

\*Coax Performance at 1 GHz Notes: Cable assembly max frequency may be lower than connector or coax max frequency

# For our complete selection of cable assemblies, please visit our website

Part No.	Cable Dia.				Attn. @ 1 GHz	Power @ 1 GHz
Part No. <a href="#">PE3447</a>	0.210" dia.				13 dB/100ft	53 W
1 piece price shown. See web or call for volume pricing.						
6"	12"	18"	24"	30"	36"	Custom Len.
\$46.03	\$47.87	\$49.43	\$50.98	\$50.38	\$54.10	See Web
<b>RG225/U Coax, 50 Ohm</b>						
Part No. <a href="#">PE33269</a>	0.430" dia.				dB/100ft	1700 W
1 piece price shown. See web or call for volume pricing.						
12"	24"	36"	48"	60"	-	Custom Len.
\$87.70	\$121.29	\$164.21	\$188.50	\$222.10	-	See Web
<b>RG316/U Coax, 50 Ohm</b>						
Part No. <a href="#">PE3487</a>	0.098" dia.				38 dB/100ft	160 W
1 piece price shown. See web or call for volume pricing.						
12"	24"	36"	48"	60"	72"	Custom Len.
\$62.06	\$65.19	\$63.24	\$66.13	\$74.81	\$71.91	See Web
<b>RG316-DS Coax, 50 Ohm</b>						
Part No. <a href="#">PE33288</a>	0.114" dia.				26 dB/100ft	160 W
1 piece price shown. See web or call for volume pricing.						
12"	24"	36"	48"	60"	-	Custom Len.
\$53.24	\$56.14	\$59.06	\$61.97	\$64.88	-	See Web
<b>RG393/U Coax, 50 Ohm</b>						
Part No. <a href="#">PE3607</a>	0.390" dia.				9 dB/100ft	1700 W
1 piece price shown. See web or call for volume pricing.						
12"	24"	36"	48"	60"	72"	Custom Len.
\$79.81	\$96.21	\$112.62	\$129.98	\$146.71	\$163.43	See Web
<b>RG400/U Coax, 50 Ohm</b>						
Part No. <a href="#">PE3653</a>	0.195" dia.				15 dB/100ft	650 W
1 piece price shown. See web or call for volume pricing.						
12"	24"	36"	48"	60"	72"	Custom Len.
\$59.97	\$67.37	\$74.76	\$82.59	\$90.12	\$97.67	See Web
<b>PE-B400 Coax, 50 Ohm</b>						
Part No. <a href="#">PE3629</a>	0.403" dia.				6 dB/100ft	190 W
1 piece price shown. See web or call for volume pricing.						
12"	24"	36"	48"	60"	-	Custom Len.
\$53.33	\$55.03	\$56.70	\$58.39	\$60.07	-	See Web
<b>PE-P141 Coax, 50 Ohm</b>						
Part No. <a href="#">PE3102</a>	0.163" dia.				dB/100ft	W
1 piece price shown. See web or call for volume pricing.						
12"	24"	36"	48"	60"	72"	Custom Len.
\$170.06	\$181.41	\$192.77	\$204.79	\$216.36	\$227.94	See Web
<b>PE-P141EAM Coax, 50 Ohm</b>						
Part No. <a href="#">PE352</a>	0.163" dia.				11 dB/100ft	600 W
1 piece price shown. See web or call for volume pricing.						
12"	24"	36"	48"	60"	72"	Custom Len.
\$123.94	\$135.30	\$146.64	\$158.67	\$170.24	\$171.13	See Web
<b>PE-P141EAM Coax, 50 Ohm</b>						
Part No. <a href="#">PE3CA1047</a>	0.163" dia.				dB/100ft	W
1 piece price shown. See web or call for volume pricing.						
12"	24"	36"	50CM	100CM	-	Custom Len.
\$89.80	\$107.29	\$124.77	\$101.00	\$129.66	-	See Web
<b>PE-P195 Coax, 50 Ohm</b>						
Part No. <a href="#">PE33377</a>	0.195" dia.				13 dB/100ft	650 W
1 piece price shown. See web or call for volume pricing.						
12"	24"	36"	48"	60"	-	Custom Len.
\$55.02	\$64.58	\$74.16	\$84.30	\$94.07	-	See Web
<b>LMR-400-UF Coax, 50 Ohm</b>						
Part No. <a href="#">PE3C0218</a>	0.405" dia.				5 dB/100ft	W
1 piece price shown. See web or call for volume pricing.						
12"	24"	36"	48"	60"	50CM	Custom Len.
\$49.23	\$51.78	\$54.34	\$56.90	\$59.45	\$50.87	See Web
<b>PE-FF430 Coax, 50 Ohm</b>						
Part No. <a href="#">PE3C4002</a>	0.430" dia.				dB/100ft	W
1 piece price shown. See web or call for volume pricing.						
60"	144"	-	-	-	-	Custom Len.
\$494.77	\$729.86	-	-	-	-	See Web
<b>PE-C4005 Coax, 50 Ohm</b>						
Part No. <a href="#">PE3C4005</a>	0.430" dia.				dB/100ft	W
1 piece price shown. See web or call for volume pricing.						
100CM	-	-	-	-	-	Custom Len.
\$637.06	-	-	-	-	-	See Web
<b>PE-VNA-R Coax, 50 Ohm</b>						
Part No. <a href="#">PE3VNA1803</a>	0.430" dia.				dB/100ft	W
1 piece price shown. See web or call for volume pricing.						
24"	36"	48"	60"	-	-	Custom Len.
\$791.80	\$918.70	\$880.58	\$1,016.11	-	-	See Web
<b>Standard Semi-Rigid Cable Assemblies</b>						
<b>PE-047SR Coax, 50 Ohm</b>						
Part No. <a href="#">PE34142</a>	0.047" dia.				40 dB/100ft	32 W
1 piece price shown. See web or call for volume pricing.						
6"	12"	18"	24"	36"	48"	Custom Len.
\$91.23	\$102.01	\$101.21	\$113.07	\$116.10	\$125.99	See Web
<b>PE-SR402AL Coax, 50 Ohm</b>						
Part No. <a href="#">PE34138</a>	" dia.				13 dB/100ft	450 W
1 piece price shown. See web or call for volume pricing.						
6"	12"	18"	24"	36"	48"	Custom Len.
\$79.32	\$84.25	\$89.34	\$88.61	\$97.73	\$106.85	See Web

Part No.	Cable Dia.				Attn. @ 1 GHz	Power @ 1 GHz
Part No. <a href="#">PE34140</a>	" dia.				23 dB/100ft	130 W
1 piece price shown. See web or call for volume pricing.						
6"	12"	18"	24"	36"	48"	Custom Len.
\$99.30	\$103.48	\$107.68	\$111.83	\$120.23	\$128.57	See Web
<b>RG401/U Coax, 50 Ohm</b>						
Part No. <a href="#">PE3782</a>	" dia.				8 dB/100ft	870 W
1 piece price shown. See web or call for volume pricing.						
6"	12"	18"	24"	36"	48"	Custom Len.
\$139.59	\$139.59	\$150.57	\$161.53	\$183.48	\$217.29	See Web
<b>RG402/U Coax, 50 Ohm</b>						
Part No. <a href="#">PE3827</a>	" dia.				12 dB/100ft	650 W
1 piece price shown. See web or call for volume pricing.						
6"	12"	18"	24"	36"	48"	Custom Len.
\$82.09	\$82.09	\$90.93	\$94.84	\$96.70	\$104.00	See Web
<b>RG405/U Coax, 50 Ohm</b>						
Part No. <a href="#">PE3920</a>	" dia.				22 dB/100ft	130 W
1 piece price shown. See web or call for volume pricing.						
6"	12"	18"	24"	36"	48"	Custom Len.
\$98.45	\$101.74	\$105.11	\$108.41	\$122.70	\$121.74	See Web
<b>PE-SR401AL-STRAIGHT Coax, 50 Ohm</b>						
Part No. <a href="#">PE3995</a>	0.250" dia.				8 dB/100ft	1400 W
1 piece price shown. See web or call for volume pricing.						
6"	12"	18"	24"	36"	48"	Custom Len.
\$135.72	\$143.87	\$144.80	\$153.87	\$172.02	\$190.16	See Web
<b>Standard Flexible Cable Assemblies</b>						
<b>RG55B/U Coax, 53 Ohm</b>						
Part No. <a href="#">PE3499</a>	" dia.				17 dB/100ft	53 W
1 piece price shown. See web or call for volume pricing.						
12"	24"	36"	48"	60"	72"	Custom Len.
\$47.01	\$49.26	\$51.49	\$53.74	\$55.98	\$58.22	See Web
<b>RG11A/U Coax, 75 Ohm</b>						
Part No. <a href="#">PE33479</a>	0.405" dia.				dB/100ft	150 W
1 piece price shown. See web or call for volume pricing.						
12"	24"	36"	48"	60"	-	Custom Len.
\$65.51	\$67.58	\$65.24	\$66.94	\$68.67	-	See Web
<b>N MALE TO N MALE RIGHT ANGLE</b>						
<b>Flexible Cable Assemblies</b>						
<b>PE-P142LL Coax, 50 Ohm</b>						
Part No. <a href="#">PE345</a>	0.195" dia.				7 dB/100ft	820 W
1 piece price shown. See web or call for volume pricing.						
12"	24"	36"	48"	60"	50CM	Custom Len.
\$222.67	\$238.90	\$255.14	\$271.38	\$287.61	\$233.08	See Web
<b>Precision Formable Cable Assemblies</b>						
<b>PE-SR402FL Coax, 50 Ohm</b>						
Part No. <a href="#">PE39453</a>	" dia.				12 dB/100ft	450 W
1 piece price shown. See web or call for volume pricing.						
6"	9"	12"	18"	24"	-	Custom Len.
\$58.55	\$60.51	\$57.84	\$83.39	\$88.71	-	See Web
<b>Low Loss Formable Cable Assemblies</b>						
<b>LMR-SW396 Coax, 50 Ohm</b>						
Part No. <a href="#">PE3C0144</a>	0.450" dia.				3 dB/100ft	W
1 piece price shown. See web or call for volume pricing.						
12"	24"	36"	48"	60"	-	Custom Len.
\$86.49	\$88.84	\$91.20	\$93.58	\$95.94	-	See Web
<b>Low Loss Flexible Cable Assemblies</b>						
<b>PE-C100-LSZH Coax, 50 Ohm</b>						
Part No. <a href="#">PE38934</a>	0.109" dia.				25 dB/100ft	W
1 piece price shown. See web or call for volume pricing.						
12"	24"	36"	48"	60"	-	Custom Len.
\$54.17	\$55.37	\$56.57	\$57.78	\$58.98	-	See Web
<b>PE-C195 Coax, 50 Ohm</b>						
Part No. <a href="#">PE37944</a>	0.195" dia.				11 dB/100ft	150 W
1 piece price shown. See web or call for volume pricing.						
36"	48"	60"	72"	120"	-	Custom Len.
\$50.65	\$51.37	\$52.06	\$52.78	\$55.64	-	See Web
<b>PE-C240 Coax, 50 Ohm</b>						
Part No. <a href="#">PE37945</a>	0.240" dia.				9 dB/100ft	250 W
1 piece price shown. See web or call for volume pricing.						
36"	48"	60"	72"	120"	-	Custom Len.
\$61.06	\$62.03	\$63.00	\$65.61	\$76.27	-	See Web
<b>PE-C400 Coax, 50 Ohm</b>						
Part No. <a href="#">PE37946</a>	0.400" dia.				4 dB/100ft	550 W
1 piece price shown. See web or call for volume pricing.						
36"	48"	60"	72"	120"	-	Custom Len.
\$86.78	\$88.35	\$89.86	\$92.95	\$97.45	-	See Web
<b>PE-C600 Coax, 50 Ohm</b>						

Cable Assemblies

See Our Website For Current Pricing & Real-Time Stock Availability!

Continued on Next Page

For Custom Lengths, Metric Lengths or Special Configurations, Please call (949) 261-1920



Technical Support  
+1 (949) 261-1920



Same-Day Shipping,  
Even Custom Cable Assemblies

For our complete selection of cable assemblies, please visit our website

Part No.	Cable Dia.	Attn. @ 1 GHz	Power @ 1 GHz
<b>Part No. PE37947</b>	0.590" dia.	3 dB/100ft	900 W
1 piece price shown. See web or call for volume pricing.			
36"	48"	60"	72"
\$124.30	\$126.76	\$137.18	\$131.71
		\$141.62	-
		-	Custom Len.
			See Web
<b>LMR-400 Coax, 50 Ohm</b>			
<b>Part No. PE3C0041</b>	0.405" dia.	4 dB/100ft	W
1 piece price shown. See web or call for volume pricing.			
12"	24"	36"	48"
\$78.06	\$75.03	\$76.39	\$82.29
			\$83.69
			Custom Len.
			See Web
<b>Part No. PE3C0106</b>	0.405" dia.	4 dB/100ft	W
1 piece price shown. See web or call for volume pricing.			
12"	24"	36"	48"
\$78.17	\$81.90	\$80.92	\$82.29
			\$86.15
			Custom Len.
			See Web
<b>Part No. PE3W00430</b>	0.405" dia.	4 dB/100ft	W
1 piece price shown. See web or call for volume pricing.			
12"	24"	36"	48"
\$75.45	\$76.70	\$77.95	\$79.19
			\$80.44
			50CM Custom Len.
			See Web
<b>LMR-400-DB Coax, 50 Ohm</b>			
<b>Part No. PE3W01127</b>	0.405" dia.	4 dB/100ft	W
1 piece price shown. See web or call for volume pricing.			
12"	24"	36"	48"
\$71.30	\$72.74	\$74.18	\$75.63
			\$77.07
			50CM Custom Len.
			See Web
<b>LMR-600 Coax, 50 Ohm</b>			
<b>Part No. PE3C0050</b>	0.590" dia.	3 dB/100ft	W
1 piece price shown. See web or call for volume pricing.			
12"	24"	36"	48"
\$106.51	\$115.73	\$112.18	\$115.01
			\$117.84
			Custom Len.
			See Web
<b>Part No. PE3C0111</b>	0.590" dia.	3 dB/100ft	W
1 piece price shown. See web or call for volume pricing.			
12"	24"	36"	48"
\$100.54	\$103.38	\$112.25	\$109.03
			\$118.14
			Custom Len.
			See Web
<b>PE-P142LL-27478 Coax, 50 Ohm</b>			
<b>Part No. PE3M0176</b>	0.195" dia.	dB/100ft	W
1 piece price shown. See web or call for volume pricing.			
12"	18"	24"	36"
\$485.09	\$493.57	\$502.04	\$519.00
			\$535.96
			60" Custom Len.
			See Web
<b>PE-P160LL-27478 Coax, 50 Ohm</b>			
<b>Part No. PE3M0221</b>	0.160" dia.	36"	W
1 piece price shown. See web or call for volume pricing.			
8"	12"	18"	24"
\$438.69	\$443.59	\$450.94	\$458.29
			\$465.64
			36" Custom Len.
			See Web
<b>PE-P300LL-27478 Coax, 50 Ohm</b>			
<b>Part No. PE3M0249</b>	0.300" dia.	dB/100ft	W
1 piece price shown. See web or call for volume pricing.			
12"	18"	24"	36"
\$563.00	\$577.15	\$591.31	\$619.61
			\$647.91
			60" Custom Len.
			See Web
<b>PE-P160LL Coax, 50 Ohm</b>			
<b>Part No. PE3C5285</b>	0.160" dia.	dB/100ft	W
1 piece price shown. See web or call for volume pricing.			
12"	24"	36"	48"
\$264.21	\$284.92	\$305.63	\$326.35
			\$347.06
			50CM Custom Len.
			See Web
<b>Low Loss Test Flexible Cable Assemblies</b>			
<b>PE-P300LL Coax, 50 Ohm</b>			
<b>Part No. PE3C3240</b>	0.300" dia.	6 dB/100ft	W
1 piece price shown. See web or call for volume pricing.			
12"	24"	36"	48"
\$250.85	\$276.78	\$302.71	\$328.65
			\$354.59
			50CM Custom Len.
			See Web
<b>Standard Flexible Cable Assemblies</b>			
<b>RG8A/U Coax, 50 Ohm</b>			
<b>Part No. PE3699</b>	0.405" dia.	8 dB/100ft	190 W
1 piece price shown. See web or call for volume pricing.			
12"	24"	36"	48"
\$81.97	\$88.32	\$91.39	\$94.64
			\$93.30
			72" Custom Len.
			See Web
<b>RG58C/U Coax, 50 Ohm</b>			
<b>Part No. PE3143</b>	0.195" dia.	20 dB/100ft	44 W
1 piece price shown. See web or call for volume pricing.			
12"	24"	36"	48"
\$66.55	\$67.37	\$63.09	\$63.83
			\$64.55
			72" Custom Len.
			See Web
<b>RG142B/U Coax, 50 Ohm</b>			
<b>Part No. PE3726</b>	0.195" dia.	13 dB/100ft	650 W
1 piece price shown. See web or call for volume pricing.			
12"	24"	36"	48"
\$63.13	\$71.73	\$77.81	\$84.24
			\$90.44
			60" Custom Len.
			See Web
<b>Part No. PE3W06863</b>	0.195" dia.	dB/100ft	W
1 piece price shown. See web or call for volume pricing.			
12"	24"	36"	48"
\$58.18	\$64.08	\$69.98	\$75.88
			\$81.78
			50CM Custom Len.
			See Web
<b>RG174A/U Coax, 50 Ohm</b>			
<b>Part No. PE34205</b>	0.100" dia.	32 dB/100ft	16 W
1 piece price shown. See web or call for volume pricing.			
12"	24"	36"	48"
\$64.29	\$64.73	\$65.16	\$65.59
			\$66.03
			72" Custom Len.
			See Web
<b>RG213/U Coax, 50 Ohm</b>			

Part No.	Cable Dia.	Attn. @ 1 GHz	Power @ 1 GHz
<b>Part No. PE3797</b>	0.405" dia.	8 dB/100ft	190 W
1 piece price shown. See web or call for volume pricing.			
12"	24"	36"	48"
\$82.35	\$89.08	\$90.87	\$92.76
			\$89.00
			60" Custom Len.
			See Web
<b>RG214/U Coax, 50 Ohm</b>			
<b>Part No. PE3071</b>	0.425" dia.	7 dB/100ft	170 W
1 piece price shown. See web or call for volume pricing.			
12"	24"	36"	48"
\$98.01	\$105.79	\$113.56	\$116.21
			\$129.73
			72" Custom Len.
			See Web
<b>RG223/U Coax, 50 Ohm</b>			
<b>Part No. PE3168</b>	0.209" dia.	13 dB/100ft	50 W
1 piece price shown. See web or call for volume pricing.			
12"	24"	36"	48"
\$67.74	\$65.61	\$73.97	\$77.27
			\$74.32
			72" Custom Len.
			See Web
<b>RG316/U Coax, 50 Ohm</b>			
<b>Part No. PE34210</b>	0.098" dia.	60"	160 W
1 piece price shown. See web or call for volume pricing.			
12"	24"	36"	48"
\$67.02	\$69.91	\$77.29	\$75.68
			\$78.57
			72" Custom Len.
			See Web
<b>RG316-DS Coax, 50 Ohm</b>			
<b>Part No. PE34207</b>	0.114" dia.	28 dB/100ft	160 W
1 piece price shown. See web or call for volume pricing.			
12"	24"	36"	48"
\$63.15	\$66.10	\$68.99	\$71.93
			\$74.87
			60" Custom Len.
			See Web
<b>RG393/U Coax, 50 Ohm</b>			
<b>Part No. PE3255</b>	0.390" dia.	8 dB/100ft	1700 W
1 piece price shown. See web or call for volume pricing.			
12"	24"	36"	48"
\$96.98	\$119.20	\$135.61	\$152.97
			\$169.70
			\$186.42
			Custom Len.
			See Web
<b>RG400/U Coax, 50 Ohm</b>			
<b>Part No. PE33321</b>	0.195" dia.	15 dB/100ft	650 W
1 piece price shown. See web or call for volume pricing.			
12"	24"	36"	48"
\$72.29	\$84.02	\$91.42	\$99.25
			\$100.17
			\$114.32
			72" Custom Len.
			See Web
<b>PE-P141EAM Coax, 50 Ohm</b>			
<b>Part No. PE3CA1048</b>	0.163" dia.	dB/100ft	W
1 piece price shown. See web or call for volume pricing.			
12"	24"	36"	50CM
\$83.82	\$100.13	\$116.45	\$94.26
			\$121.03
			100CM Custom Len.
			See Web
<b>LMR-400-UF Coax, 50 Ohm</b>			
<b>Part No. PE3C3643</b>	0.405" dia.	50CM	W
1 piece price shown. See web or call for volume pricing.			
12"	24"	36"	48"
\$53.08	\$55.64	\$58.19	\$60.75
			\$63.31
			\$54.72
			50CM Custom Len.
			See Web
<b>PE-FF430 Coax, 50 Ohm</b>			
<b>Part No. PE3C4003</b>	0.430" dia.	dB/100ft	W
1 piece price shown. See web or call for volume pricing.			
60"	144"	-	-
\$760.79	\$1,047.86	-	-
			-
			Custom Len.
			See Web
<b>Part No. PE3C4006</b>	0.430" dia.	dB/100ft	W
1 piece price shown. See web or call for volume pricing.			
100CM	-	-	-
\$804.09	-	-	-
			Custom Len.
			See Web
<b>N MALE TO N FEMALE</b>			
<b>Corrugated Cable Assemblies</b>			
<b>SPP-250-LLPL Coax, 50 Ohm</b>			
<b>Part No. PE3C4138</b>	0.280" dia.	6 dB/100ft	650 W
1 piece price shown. See web or call for volume pricing.			
12"	24"	36"	48"
\$87.70	\$93.28	\$98.86	\$104.44
			\$110.02
			\$91.28
			50CM Custom Len.
			See Web
<b>Precision Formable Cable Assemblies</b>			
<b>PE-SR402FLJ Coax, 50 Ohm</b>			
<b>Part No. PE39468</b>	0.161" dia.	12 dB/100ft	450 W
1 piece price shown. See web or call for volume pricing.			
6"	9"	12"	18"
\$82.38	\$85.30	\$87.33	\$86.16
			\$89.93
			-
			Custom Len.
			See Web
<b>PE-80TEST Coax, 50 Ohm</b>			
<b>Part No. PE3TC0104</b>	0.195" dia.	dB/100ft	W
1 piece price shown. See web or call for volume pricing.			
24"	48"	72"	-
\$383.91	\$469.65	\$555.40	-
			-
			Custom Len.
			See Web
<b>Low Loss Flexible Cable Assemblies</b>			
<b>PE-C195 Coax, 50 Ohm</b>			
<b>Part No. PE37948</b>	0.195" dia.	11 dB/100ft	150 W
1 piece price shown. See web or call for volume pricing.			
36"	48"	60"	72"
\$32.89	\$31.70	\$32.42	\$33.13
			\$35.98
			Custom Len.
			See Web
<b>PE-C240 Coax, 50 Ohm</b>			



Cable Assemblies See Our Website For Current Pricing & Real-Time Stock Availability!

\*Coax Performance at 1 GHz Notes: Cable assembly max frequency may be lower than connector or coax max frequency

# For our complete selection of cable assemblies, please visit our website

Part No.	Cable Dia.				Attn. @ 1 GHz	Power @ 1 GHz	42
<b>PE37949</b>	1 piece price shown. See web or call for volume pricing.				0.240" dia.	9 dB/100ft	
	36"	48"	60"	72"	120"	-	Custom Len.
	\$47.34	\$48.31	\$49.28	\$50.25	\$54.12	-	See Web
<b>PE-C400 Coax, 50 Ohm</b>							
<b>PE34716</b>	1 piece price shown. See web or call for volume pricing.				0.400" dia.	4 dB/100ft	550 W
	12"	24"	36"	48"	60"	-	Custom Len.
	\$66.58	\$67.85	\$69.10	\$70.36	\$76.64	-	See Web
<b>PE37950</b>	1 piece price shown. See web or call for volume pricing.				0.400" dia.	4 dB/100ft	550 W
	36"	48"	60"	72"	120"	-	Custom Len.
	\$69.51	\$70.83	\$72.14	\$73.46	\$78.73	-	See Web
<b>PE-C600 Coax, 50 Ohm</b>							
<b>PE37951</b>	1 piece price shown. See web or call for volume pricing.				0.590" dia.	3 dB/100ft	900 W
	36"	48"	72"	120"	-	-	Custom Len.
	\$110.03	\$112.43	\$124.93	\$126.77	-	-	See Web
<b>LMR-400 Coax, 50 Ohm</b>							
<b>PE3W00676</b>	1 piece price shown. See web or call for volume pricing.				0.405" dia.	dB/100ft	W
	12"	24"	36"	48"	60"	50CM	Custom Len.
	\$57.31	\$58.65	\$59.99	\$61.33	\$62.67	\$58.17	See Web
<b>PE-SF200LL Coax, 50 Ohm</b>							
<b>PE3TC1103</b>	1 piece price shown. See web or call for volume pricing.				0.185" dia.	dB/100ft	W
	24"	36"	48"	72"	100CM	200CM	Custom Len.
	\$75.75	\$87.02	\$98.28	\$120.79	\$90.17	\$127.12	See Web
<b>Low PIM Formable Cable Assemblies</b>							
<b>PE-SR402FLJ Low PIM Coax, 50 Ohm</b>							
<b>PE3C2001</b>	1 piece price shown. See web or call for volume pricing.				0.161" dia.	dB/100ft	W
	100CM	200CM	-	-	-	-	Custom Len.
	\$72.80	\$93.24	-	-	-	-	See Web
<b>Low Loss Test Flexible Cable Assemblies</b>							
<b>PE-P300LL Coax, 50 Ohm</b>							
<b>PE3C3241</b>	1 piece price shown. See web or call for volume pricing.				0.300" dia.	6 dB/100ft	W
	12"	24"	36"	48"	60"	50CM	Custom Len.
	\$232.13	\$257.34	\$282.55	\$307.74	\$332.95	\$248.28	See Web
<b>PE331</b>	1 piece price shown. See web or call for volume pricing.				0.300" dia.	5 dB/100ft	W
	12"	24"	36"	48"	60"	50CM	Custom Len.
	\$370.75	\$418.94	\$422.61	\$448.56	\$474.49	\$387.36	See Web
<b>Standard Formable Cable Assemblies</b>							
<b>PE-SR402FL Coax, 50 Ohm</b>							
<b>PE3485</b>	1 piece price shown. See web or call for volume pricing.				" dia.	12 dB/100ft	450 W
	6"	12"	18"	24"	36"	48"	Custom Len.
	\$83.98	\$87.64	\$91.32	\$100.98	\$102.24	\$109.54	See Web
<b>Standard Flexible Cable Assemblies</b>							
<b>RG58C/U Coax, 50 Ohm</b>							
<b>PE3714</b>	1 piece price shown. See web or call for volume pricing.				0.195" dia.	20 dB/100ft	44 W
	12"	24"	36"	48"	60"	72"	Custom Len.
	\$51.10	\$56.00	\$56.81	\$53.30	\$54.04	\$54.78	See Web
<b>RG142B/U Coax, 50 Ohm</b>							
<b>PE3996</b>	1 piece price shown. See web or call for volume pricing.				0.195" dia.	13 dB/100ft	650 W
	12"	24"	36"	48"	60"	72"	Custom Len.
	\$54.66	\$60.74	\$66.82	\$73.25	\$79.44	\$85.64	See Web
<b>RG213/U Coax, 50 Ohm</b>							
<b>PE3232</b>	1 piece price shown. See web or call for volume pricing.				0.405" dia.	9 dB/100ft	190 W
	12"	24"	36"	48"	60"	72"	Custom Len.
	\$65.82	\$67.61	\$69.39	\$71.29	\$73.11	\$74.93	See Web
<b>RG214/U Coax, 50 Ohm</b>							
<b>PE3650</b>	1 piece price shown. See web or call for volume pricing.				0.425" dia.	7 dB/100ft	190 W
	12"	24"	36"	48"	60"	72"	Custom Len.
	\$71.96	\$79.74	\$87.53	\$95.75	\$97.20	\$111.62	See Web
<b>RG217/U Coax, 50 Ohm</b>							
<b>PE34274</b>	1 piece price shown. See web or call for volume pricing.				0.545" dia.	6 dB/100ft	260 W
	12"	24"	36"	48"	60"	72"	Custom Len.
	\$128.60	\$133.00	\$137.42	\$141.81	\$146.22	\$150.62	See Web
<b>RG218/U Coax, 50 Ohm</b>							
<b>PE34276</b>	1 piece price shown. See web or call for volume pricing.				0.870" dia.	4 dB/100ft	560 W
	12"	24"	36"	48"	60"	72"	Custom Len.
	\$192.25	\$203.43	\$214.52	\$225.68	\$236.85	\$265.91	See Web
<b>RG223/U Coax, 50 Ohm</b>							

Part No.	Cable Dia.				Attn. @ 1 GHz	Power @ 1 GHz	58
<b>PE3667</b>	1 piece price shown. See web or call for volume pricing.				0.210" dia.	13 dB/100ft	
	12"	24"	36"	48"	60"	72"	Custom Len.
	\$49.72	\$49.81	\$52.71	\$59.23	\$62.41	\$65.59	See Web
<b>RG225/U Coax, 50 Ohm</b>							
<b>PE33728</b>	1 piece price shown. See web or call for volume pricing.				0.430" dia.	dB/100ft	1700 W
	12"	24"	36"	48"	60"	72"	Custom Len.
	\$88.07	\$120.66	\$153.24	\$185.83	\$218.42	\$251.00	See Web
<b>RG316/U Coax, 50 Ohm</b>							
<b>PE3986</b>	1 piece price shown. See web or call for volume pricing.				0.098" dia.	38 dB/100ft	160 W
	12"	24"	36"	48"	60"	72"	Custom Len.
	\$61.79	\$68.63	\$67.58	\$70.46	\$73.34	\$76.23	See Web
<b>RG393/U Coax, 50 Ohm</b>							
<b>PE3977</b>	1 piece price shown. See web or call for volume pricing.				0.390" dia.	9 dB/100ft	1700 W
	12"	24"	36"	48"	60"	72"	Custom Len.
	\$79.87	\$96.27	\$112.68	\$130.04	\$137.22	\$152.68	See Web
<b>RG400/U Coax, 50 Ohm</b>							
<b>PE3617</b>	1 piece price shown. See web or call for volume pricing.				0.195" dia.	15 dB/100ft	650 W
	12"	24"	36"	48"	60"	72"	Custom Len.
	\$63.24	\$70.63	\$78.03	\$85.85	\$93.40	\$94.50	See Web
<b>PE3W07899</b>	1 piece price shown. See web or call for volume pricing.				0.195" dia.	15 dB/100ft	600 W
	12"	18"	24"	36"	48"	60"	Custom Len.
	\$58.65	\$62.31	\$65.98	\$73.31	\$80.64	\$87.97	See Web
<b>PE-FF430 Coax, 50 Ohm</b>							
<b>PE3C4004</b>	1 piece price shown. See web or call for volume pricing.				0.430" dia.	dB/100ft	W
	60"	144"	-	-	-	-	Custom Len.
	\$494.77	\$729.86	-	-	-	-	See Web
<b>PE3C4007</b>	1 piece price shown. See web or call for volume pricing.				0.430" dia.	dB/100ft	W
	100CM	-	-	-	-	-	Custom Len.
	\$637.06	-	-	-	-	-	See Web
<b>PE-VNA-R Coax, 50 Ohm</b>							
<b>PE3VNA1804</b>	1 piece price shown. See web or call for volume pricing.				0.430" dia.	dB/100ft	W
	24"	48"	-	-	-	-	Custom Len.
	\$806.69	\$896.00	-	-	-	-	See Web
<b>Standard Semi-Rigid Cable Assemblies</b>							
<b>PE-SR402AL Coax, 50 Ohm</b>							
<b>PE34289</b>	1 piece price shown. See web or call for volume pricing.				0.141" dia.	13 dB/100ft	450 W
	6"	12"	18"	24"	36"	48"	Custom Len.
	\$84.95	\$89.51	\$94.07	\$98.62	\$107.74	\$116.88	See Web
<b>RG401/U Coax, 50 Ohm</b>							
<b>PE3979</b>	1 piece price shown. See web or call for volume pricing.				" dia.	8 dB/100ft	870 W
	6"	12"	18"	24"	36"	48"	Custom Len.
	\$103.48	\$114.10	\$124.79	\$135.41	\$170.84	\$178.03	See Web
<b>RG402/U Coax, 50 Ohm</b>							
<b>PE3829</b>	1 piece price shown. See web or call for volume pricing.				" dia.	12 dB/100ft	650 W
	6"	12"	18"	24"	36"	48"	Custom Len.
	\$92.71	\$92.71	\$96.37	\$100.01	\$107.32	\$114.62	See Web
<b>RG405/U Coax, 50 Ohm</b>							
<b>PE3921</b>	1 piece price shown. See web or call for volume pricing.				" dia.	22 dB/100ft	130 W
	6"	12"	18"	24"	36"	48"	Custom Len.
	\$88.54	\$91.85	\$95.21	\$98.52	\$105.17	\$111.83	See Web
<b>PE-SR401AL-STRAIGHT Coax, 50 Ohm</b>							
<b>PE3988</b>	1 piece price shown. See web or call for volume pricing.				0.250" dia.	8 dB/100ft	1400 W
	6"	12"	18"	24"	36"	48"	Custom Len.
	\$101.63	\$110.39	\$119.21	\$127.98	\$145.56	\$163.14	See Web
<b>N MALE TO N FEMALE BULKHEAD</b>							
SEE MOUNTING HOLE SECTION ON PAGE 369							
<b>Flexible Cable Assemblies</b>							
<b>LMR-400-UF Coax, 50 Ohm</b>							
<b>PE3W02547</b>	1 piece price shown. See web or call for volume pricing.				0.405" dia.	5 dB/100ft	W
	12"	24"	36"	48"	60"	50CM	Custom Len.
	\$53.77	\$65.09	\$67.72	\$70.35	\$72.98	\$64.16	See Web
<b>Low Loss Flexible Cable Assemblies</b>							
<b>PE-C240 Coax, 50 Ohm</b>							
<b>PE38672</b>	1 piece price shown. See web or call for volume pricing.				0.240" dia.	9 dB/100ft	250 W
	36"	48"	60"	72"	120"	-	Custom Len.
	\$52.95	\$50.72	\$52.54	\$56.47	\$66.58	-	See Web

Cable Assemblies

See Our Website For Current Pricing & Real-Time Stock Availability!



For Custom Lengths, Metric Lengths or Special Configurations, Please call (949) 261-1920



Technical Support  
+1 (949) 261-1920



Same-Day Shipping,  
Even Custom Cable Assemblies

# For our complete selection of cable assemblies, please visit our website

Cable Assemblies  
See Our Website For Current Pricing & Real-Time Stock Availability!

PE-P142LL Coax, 50 Ohm						
Part No. <a href="#">PE344</a>	Cable Dia.			Attn. @ 1 GHz	Power @ 1 GHz	
1 piece price shown. See web or call for volume pricing.						
12"	24"	36"	48"	0.195" dia.	10 dB/100ft	W
\$182.82	\$199.06	\$215.30	\$231.53	\$247.77	50CM	Custom Len.
					\$193.22	See Web
PE-P142LL-27478 Coax, 50 Ohm						
Part No. <a href="#">PE3M0175</a>	Cable Dia.			Attn. @ 1 GHz	Power @ 1 GHz	
1 piece price shown. See web or call for volume pricing.						
12"	18"	24"	36"	0.195" dia.	dB/100ft	W
\$457.25	\$465.73	\$474.21	\$491.17	\$508.12	60"	Custom Len.
					\$525.08	See Web
PE-P160LL-27478 Coax, 50 Ohm						
Part No. <a href="#">PE3M0220</a>	Cable Dia.			Attn. @ 1 GHz	Power @ 1 GHz	
1 piece price shown. See web or call for volume pricing.						
8"	12"	18"	24"	0.160" dia.	dB/100ft	W
\$442.62	\$447.52	\$454.87	\$462.22	\$469.20	30"	Custom Len.
					\$476.92	See Web
PE-P300LL-27478 Coax, 50 Ohm						
Part No. <a href="#">PE3M0248</a>	Cable Dia.			Attn. @ 1 GHz	Power @ 1 GHz	
1 piece price shown. See web or call for volume pricing.						
12"	18"	24"	36"	0.300" dia.	dB/100ft	W
\$493.73	\$507.88	\$522.04	\$550.34	\$578.64	48"	Custom Len.
					\$606.94	See Web
PE-P160LL Coax, 50 Ohm						
Part No. <a href="#">PE3C5257</a>	Cable Dia.			Attn. @ 1 GHz	Power @ 1 GHz	
1 piece price shown. See web or call for volume pricing.						
12"	24"	36"	48"	0.160" dia.	dB/100ft	W
\$231.73	\$252.45	\$273.15	\$293.87	\$314.58	50CM	Custom Len.
					\$245.00	See Web
Standard Formable Cable Assemblies						
PE-SR401FL Coax, 50 Ohm						
Part No. <a href="#">PE34150</a>	Cable Dia.			Attn. @ 1 GHz	Power @ 1 GHz	
1 piece price shown. See web or call for volume pricing.						
6"	12"	18"	24"	* dia.	8 dB/100ft	1400 W
\$101.74	\$109.24	\$116.69	\$124.19	\$139.13	48"	Custom Len.
					\$154.08	See Web
PE-SR402FL Coax, 50 Ohm						
Part No. <a href="#">PE3488</a>	Cable Dia.			Attn. @ 1 GHz	Power @ 1 GHz	
1 piece price shown. See web or call for volume pricing.						
6"	12"	18"	24"	* dia.	12 dB/100ft	450 W
\$91.70	\$91.70	\$95.47	\$99.23	\$106.78	36"	Custom Len.
					\$114.32	See Web
Standard Flexible Cable Assemblies						
RG8/U Coax, 50 Ohm						
Part No. <a href="#">PE3966</a>	Cable Dia.			Attn. @ 1 GHz	Power @ 1 GHz	
1 piece price shown. See web or call for volume pricing.						
12"	24"	36"	48"	0.405" dia.	8 dB/100ft	190 W
\$79.95	\$78.25	\$81.08	\$83.92	\$86.75	60"	Custom Len.
					\$89.58	See Web
RG58C/U Coax, 50 Ohm						
Part No. <a href="#">PE3320</a>	Cable Dia.			Attn. @ 1 GHz	Power @ 1 GHz	
1 piece price shown. See web or call for volume pricing.						
12"	24"	36"	48"	0.195" dia.	20 dB/100ft	44 W
\$56.02	\$56.84	\$54.32	\$58.52	\$55.79	60"	Custom Len.
					\$56.53	See Web
RG142B/U Coax, 50 Ohm						
Part No. <a href="#">PE3034</a>	Cable Dia.			Attn. @ 1 GHz	Power @ 1 GHz	
1 piece price shown. See web or call for volume pricing.						
12"	24"	36"	48"	0.195" dia.	13 dB/100ft	W
\$57.33	\$63.41	\$69.49	\$75.93	\$82.12	72"	Custom Len.
					\$88.32	See Web
RG188A/U Coax, 50 Ohm						
Part No. <a href="#">PE34181</a>	Cable Dia.			Attn. @ 1 GHz	Power @ 1 GHz	
1 piece price shown. See web or call for volume pricing.						
12"	24"	36"	48"	0.110" dia.	26 dB/100ft	160 W
\$62.98	\$65.13	\$67.23	\$69.41	\$71.57	72"	Custom Len.
					\$73.65	See Web
RG213/U Coax, 50 Ohm						
Part No. <a href="#">PE33543</a>	Cable Dia.			Attn. @ 1 GHz	Power @ 1 GHz	
1 piece price shown. See web or call for volume pricing.						
12"	24"	36"	48"	0.405" dia.	8 dB/100ft	190 W
\$74.28	\$75.93	\$77.60	\$79.25	\$80.92	60"	Custom Len.
					\$82.58	See Web
RG214/U Coax, 50 Ohm						
Part No. <a href="#">PE3217</a>	Cable Dia.			Attn. @ 1 GHz	Power @ 1 GHz	
1 piece price shown. See web or call for volume pricing.						
12"	24"	36"	48"	0.425" dia.	7 dB/100ft	170 W
\$69.61	\$77.40	\$85.18	\$87.66	\$94.99	72"	Custom Len.
					\$102.30	See Web
RG223/U Coax, 50 Ohm						
Part No. <a href="#">PE3686</a>	Cable Dia.			Attn. @ 1 GHz	Power @ 1 GHz	
1 piece price shown. See web or call for volume pricing.						
12"	24"	36"	48"	0.210" dia.	13 dB/100ft	53 W
\$52.27	\$55.18	\$58.08	\$65.98	\$63.87	72"	Custom Len.
					\$72.32	See Web
RG225/U Coax, 50 Ohm						
Part No. <a href="#">PE34194</a>	Cable Dia.			Attn. @ 1 GHz	Power @ 1 GHz	
1 piece price shown. See web or call for volume pricing.						
12"	24"	36"	48"	0.430" dia.	dB/100ft	1700 W
\$87.17	\$119.77	\$152.36	\$184.94	\$217.53	72"	Custom Len.
					\$250.12	See Web
RG316/U Coax, 50 Ohm						
Part No. <a href="#">PE33534</a>	Cable Dia.			Attn. @ 1 GHz	Power @ 1 GHz	
1 piece price shown. See web or call for volume pricing.						
12"	24"	36"	48"	0.098" dia.	38 dB/100ft	160 W
\$67.72	\$70.60	\$73.50	\$76.39	\$84.53	72"	Custom Len.
					\$82.15	See Web

RG393/U Coax, 50 Ohm						
Part No. <a href="#">PE33530</a>	Cable Dia.			Attn. @ 1 GHz	Power @ 1 GHz	
1 piece price shown. See web or call for volume pricing.						
12"	24"	36"	48"	0.390" dia.	8 dB/100ft	1700 W
\$72.93	\$88.39	\$103.86	\$119.33	\$134.79	72"	Custom Len.
					\$150.26	See Web
RG400/U Coax, 50 Ohm						
Part No. <a href="#">PE3227</a>	Cable Dia.			Attn. @ 1 GHz	Power @ 1 GHz	
1 piece price shown. See web or call for volume pricing.						
12"	24"	36"	48"	0.195" dia.	15 dB/100ft	600 W
\$68.22	\$75.62	\$77.10	\$90.84	\$91.05	72"	Custom Len.
					\$105.92	See Web
PE-P141 Coax, 50 Ohm						
Part No. <a href="#">PE3C3255</a>	Cable Dia.			Attn. @ 1 GHz	Power @ 1 GHz	
1 piece price shown. See web or call for volume pricing.						
12"	24"	36"	48"	0.163" dia.	11 dB/100ft	550 W
\$83.35	\$94.37	\$105.40	\$116.42	\$127.44	50CM	Custom Len.
					\$90.41	See Web
Standard Semi-Rigid Cable Assemblies						
PE-SR405AL Coax, 50 Ohm						
Part No. <a href="#">PE34161</a>	Cable Dia.			Attn. @ 1 GHz	Power @ 1 GHz	
1 piece price shown. See web or call for volume pricing.						
6"	12"	18"	24"	* dia.	23 dB/100ft	130 W
\$97.43	\$101.63	\$105.82	\$109.97	\$118.38	48"	Custom Len.
					\$126.72	See Web
RG401/U Coax, 50 Ohm						
Part No. <a href="#">PE3983</a>	Cable Dia.			Attn. @ 1 GHz	Power @ 1 GHz	
1 piece price shown. See web or call for volume pricing.						
6"	12"	18"	24"	* dia.	8 dB/100ft	870 W
\$122.49	\$122.49	\$133.45	\$144.43	\$166.38	48"	Custom Len.
					\$188.32	See Web
RG402/U Coax, 50 Ohm						
Part No. <a href="#">PE3C3286</a>	Cable Dia.			Attn. @ 1 GHz	Power @ 1 GHz	
1 piece price shown. See web or call for volume pricing.						
12"	24"	36"	48"	* dia.	60"	39.37"
\$70.27	\$77.86	\$85.46	\$93.05	\$100.65	Call	See Web
PE-SR405AL Coax, 50 Ohm						
Part No. <a href="#">PE3830</a>	Cable Dia.			Attn. @ 1 GHz	Power @ 1 GHz	
1 piece price shown. See web or call for volume pricing.						
6"	12"	18"	24"	* dia.	12 dB/100ft	650 W
\$84.69	\$84.69	\$88.35	\$97.59	\$99.31	48"	Custom Len.
					\$106.60	See Web
RG405/U Coax, 50 Ohm						
Part No. <a href="#">PE3922</a>	Cable Dia.			Attn. @ 1 GHz	Power @ 1 GHz	
1 piece price shown. See web or call for volume pricing.						
6"	12"	18"	24"	* dia.	22 dB/100ft	130 W
\$108.63	\$105.88	\$115.95	\$112.76	\$119.63	48"	Custom Len.
					\$126.50	See Web
PE-SR401AL-STRAIGHT Coax, 50 Ohm						
Part No. <a href="#">PE3993</a>	Cable Dia.			Attn. @ 1 GHz	Power @ 1 GHz	
1 piece price shown. See web or call for volume pricing.						
6"	12"	18"	24"	* dia.	8 dB/100ft	1400 W
\$103.07	\$111.90	\$120.66	\$129.48	\$147.06	48"	Custom Len.
					\$164.65	See Web
N MALE TO N FEMALE 4 HOLE FLANGE						
SEE MOUNTING HOLE SECTION ON PAGE 369						
Low Loss Flexible Cable Assemblies						
LMR-195 Coax, 50 Ohm						
Part No. <a href="#">PE3W02012</a>	Cable Dia.			Attn. @ 1 GHz	Power @ 1 GHz	
1 piece price shown. See web or call for volume pricing.						
12"	24"	36"	48"	0.195" dia.	12 dB/100ft	W
\$46.89	\$47.62	\$48.34	\$49.07	\$49.80	50CM	Custom Len.
					\$47.36	See Web
N MALE TO QMA MALE						
Corrugated Cable Assemblies						
SPP-250-LLPL Coax, 50 Ohm						
Part No. <a href="#">PE3C5868</a>	Cable Dia.			Attn. @ 1 GHz	Power @ 1 GHz	
1 piece price shown. See web or call for volume pricing.						
12"	24"	36"	48"	0.280" dia.	6 dB/100ft	650 W
\$75.40	\$80.98	\$86.56	\$92.14	\$97.72	50CM	Custom Len.
					\$78.97	See Web
N MALE TO QMA MALE RIGHT ANGLE						
Low Loss Flexible Cable Assemblies						
LMR-195 Coax, 50 Ohm						
Part No. <a href="#">PE3C0049</a>	Cable Dia.			Attn. @ 1 GHz	Power @ 1 GHz	
1 piece price shown. See web or call for volume pricing.						
12"	24"	36"	48"	0.195" dia.	12 dB/100ft	W
\$48.41	\$51.09	\$51.85	\$52.64	\$53.39	-	Custom Len.
					-	See Web
LMR-240-UF Coax, 50 Ohm						
Part No. <a href="#">PE3W08119</a>	Cable Dia.			Attn. @ 1 GHz	Power @ 1 GHz	
1 piece price shown. See web or call for volume pricing.						
12"	18"	24"	36"	0.240" dia.	9 dB/100ft	W
\$46.80	\$47.45	\$48.10	\$49.40	\$50.70	60"	Custom Len.
					\$52.00	See Web

\*Coax Performance at 1 GHz Notes: Cable assembly max frequency may be lower than connector or coax max frequency

For our complete selection of cable assemblies, please visit our website

Low PIM Corrugated Cable Assemblies							
SPP-250-LLPL Coax, 50 Ohm							
Part No.	PE3C5874				Cable Dia.	Attn. @ 1 GHz	Power @ 1 GHz
1 piece price shown. See web or call for volume pricing.							
12"	24"	36"	48"	0.280" dia.	dB/100ft	W	
\$77.57	\$83.15	\$88.73	\$94.31	60"	50CM	Custom Len.	

**N MALE TO QMA FEMALE**



Low PIM Corrugated Cable Assemblies							
SPP-250-LLPL Coax, 50 Ohm							
Part No.	PE3C5862				Cable Dia.	Attn. @ 1 GHz	Power @ 1 GHz
1 piece price shown. See web or call for volume pricing.							
12"	24"	36"	48"	0.280" dia.	dB/100ft	W	
\$71.81	\$77.38	\$82.96	\$88.54	60"	50CM	Custom Len.	

**N MALE TO QN MALE**



Low Loss Flexible Cable Assemblies							
PE-C195 Coax, 50 Ohm							
Part No.	PE38453				Cable Dia.	Attn. @ 1 GHz	Power @ 1 GHz
1 piece price shown. See web or call for volume pricing.							
12"	24"	36"	48"	0.195" dia.	11 dB/100ft	150 W	
\$63.97	\$64.68	\$65.39	\$70.19	60"	72"	Custom Len.	

**Standard Flexible Cable Assemblies**

RG58C/U Coax, 50 Ohm							
Part No.	PE38452				Cable Dia.	Attn. @ 1 GHz	Power @ 1 GHz
1 piece price shown. See web or call for volume pricing.							
12"	24"	36"	48"	0.195" dia.	20 dB/100ft	44 W	
\$62.80	\$58.43	\$59.24	\$65.02	60"	72"	Custom Len.	

**RG213/U Coax, 50 Ohm**

Part No.	PE38450				Cable Dia.	Attn. @ 1 GHz	Power @ 1 GHz
1 piece price shown. See web or call for volume pricing.							
12"	24"	36"	48"	0.405" dia.	8 dB/100ft	190 W	
\$104.51	\$106.19	\$107.87	\$109.54	60"	72"	Custom Len.	

**RG223/U Coax, 50 Ohm**

Part No.	PE38451				Cable Dia.	Attn. @ 1 GHz	Power @ 1 GHz
1 piece price shown. See web or call for volume pricing.							
12"	24"	36"	48"	0.210" dia.	13 dB/100ft	53 W	
\$66.39	\$69.28	\$72.19	\$75.09	60"	72"	Custom Len.	

**N MALE TO QN MALE RIGHT ANGLE**



Low Loss Flexible Cable Assemblies							
PE-C195 Coax, 50 Ohm							
Part No.	PE38490				Cable Dia.	Attn. @ 1 GHz	Power @ 1 GHz
1 piece price shown. See web or call for volume pricing.							
12"	24"	36"	48"	0.195" dia.	11 dB/100ft	150 W	
\$67.66	\$68.38	\$69.09	\$69.80	60"	72"	Custom Len.	

**LMR-195 Coax, 50 Ohm**

Part No.	PE3C0059				Cable Dia.	Attn. @ 1 GHz	Power @ 1 GHz
1 piece price shown. See web or call for volume pricing.							
12"	24"	36"	48"	0.195" dia.	12 dB/100ft	W	
\$59.98	\$60.69	\$61.38	\$62.07	60"	-	Custom Len.	

**Standard Flexible Cable Assemblies**

RG58C/U Coax, 50 Ohm							
Part No.	PE38489				Cable Dia.	Attn. @ 1 GHz	Power @ 1 GHz
1 piece price shown. See web or call for volume pricing.							
12"	24"	36"	48"	0.195" dia.	20 dB/100ft	44 W	
\$80.45	\$81.18	\$81.91	\$82.65	60"	72"	Custom Len.	

**RG223/U Coax, 50 Ohm**

Part No.	PE38492				Cable Dia.	Attn. @ 1 GHz	Power @ 1 GHz
1 piece price shown. See web or call for volume pricing.							
12"	24"	36"	48"	0.210" dia.	13 dB/100ft	53 W	
\$67.12	\$74.26	\$77.37	\$75.89	60"	72"	Custom Len.	

**N MALE TO SHV PLUG**



Standard Flexible Cable Assemblies							
RG223/U Coax, 50 Ohm							
Part No.	PE3W04051				Cable Dia.	Attn. @ 1 GHz	Power @ 1 GHz
1 piece price shown. See web or call for volume pricing.							
12"	24"	36"	48"	0.209" dia.	13 dB/100ft	50 W	
\$61.60	\$64.84	\$68.09	\$71.33	60"	50CM	Custom Len.	

**N MALE TO SMA MALE**



Low Loss Flexible Cable Assemblies							
PE-P160LL Coax, 50 Ohm							
Part No.	PE3C5273				Cable Dia.	Attn. @ 1 GHz	Power @ 1 GHz
1 piece price shown. See web or call for volume pricing.							
12"	24"	36"	48"	0.160" dia.	dB/100ft	W	
\$205.44	\$226.16	\$246.87	\$267.58	60"	50CM	Custom Len.	

**Low PIM Formable Cable Assemblies**

PE-SR402FLJ Low PIM Coax, 50 Ohm							
Part No.	PE3C2006				Cable Dia.	Attn. @ 1 GHz	Power @ 1 GHz
1 piece price shown. See web or call for volume pricing.							
100CM	200CM	-	-	0.161" dia.	dB/100ft	W	
\$76.69	\$99.59	-	-	-	-	Custom Len.	

**Low PIM Corrugated Cable Assemblies**

SPP-250-LLPL Coax, 50 Ohm							
Part No.	PE3C5887				Cable Dia.	Attn. @ 1 GHz	Power @ 1 GHz
1 piece price shown. See web or call for volume pricing.							
12"	24"	36"	48"	0.280" dia.	dB/100ft	W	
\$68.18	\$73.76	\$79.34	\$84.92	60"	50CM	Custom Len.	

**Low Loss Test Flexible Cable Assemblies**

PE-P300LL Coax, 50 Ohm							
Part No.	PE3332				Cable Dia.	Attn. @ 1 GHz	Power @ 1 GHz
1 piece price shown. See web or call for volume pricing.							
12"	24"	36"	48"	0.300" dia.	5 dB/100ft	W	
\$263.44	\$289.38	\$366.65	\$341.25	60"	60"	Custom Len.	

Part No.	PE3337				Cable Dia.	Attn. @ 1 GHz	Power @ 1 GHz
1 piece price shown. See web or call for volume pricing.							
12"	24"	36"	48"	0.300" dia.	dB/100ft	W	
\$254.52	\$280.47	\$306.40	\$332.34	60"	72"	Custom Len.	

**Standard Flexible Cable Assemblies**

RG58C/U Coax, 50 Ohm							
Part No.	PE3662				Cable Dia.	Attn. @ 1 GHz	Power @ 1 GHz
1 piece price shown. See web or call for volume pricing.							
12"	24"	36"	48"	0.195" dia.	20 dB/100ft	44 W	
\$42.38	\$43.19	\$44.74	\$44.86	60"	72"	Custom Len.	

**RG316/U Coax, 50 Ohm**

Part No.	PE3234				Cable Dia.	Attn. @ 1 GHz	Power @ 1 GHz
1 piece price shown. See web or call for volume pricing.							
12"	24"	36"	48"	0.102" dia.	38 dB/100ft	W	
\$49.14	\$52.27	\$56.50	\$58.70	60"	72"	Custom Len.	

**PE-P141 Coax, 50 Ohm**

Part No.	PE354				Cable Dia.	Attn. @ 1 GHz	Power @ 1 GHz
1 piece price shown. See web or call for volume pricing.							
12"	24"	36"	48"	0.163" dia.	11 dB/100ft	600 W	
\$167.12	\$178.47	\$189.83	\$201.85	60"	72"	Custom Len.	

**PE-FF430 Coax, 50 Ohm**

Part No.	PE3C4008				Cable Dia.	Attn. @ 1 GHz	Power @ 1 GHz
1 piece price shown. See web or call for volume pricing.							
60"	-	-	-	0.430" dia.	dB/100ft	W	
\$689.65	-	-	-	-	-	Custom Len.	

**PE-VNA-R Coax, 50 Ohm**

Part No.	PE3VNA1805				Cable Dia.	Attn. @ 1 GHz	Power @ 1 GHz
1 piece price shown. See web or call for volume pricing.							
24"	36"	48"	-	0.430" dia.	dB/100ft	W	
\$870.00	\$918.70	\$967.40	-	-	-	Custom Len.	

**Standard Semi-Rigid Cable Assemblies**

RG401/U Coax, 50 Ohm							
Part No.	PE3W04229				Cable Dia.	Attn. @ 1 GHz	Power @ 1 GHz
1 piece price shown. See web or call for volume pricing.							
12"	24"	36"	48"	" dia.	8 dB/100ft	1400 W	
\$103.34	\$126.39	\$149.41	\$172.51	60"	50CM	Custom Len.	

**RG402/U Coax, 50 Ohm**

Part No.	PE3887				Cable Dia.	Attn. @ 1 GHz	Power @ 1 GHz
1 piece price shown. See web or call for volume pricing.							
6"	12"	18"	24"	" dia.	11 dB/100ft	450 W	
\$69.06	\$67.46	\$76.77	\$80.68	36"	48"	Custom Len.	

**N MALE TO SMA MALE RIGHT ANGLE**



Low Loss Flexible Cable Assemblies							
PE-P160LL Coax, 50 Ohm							
Part No.	PE3C5275				Cable Dia.	Attn. @ 1 GHz	Power @ 1 GHz
1 piece price shown. See web or call for volume pricing.							
12"	24"	36"	48"	0.160" dia.	dB/100ft	W	
\$242.55	\$263.27	\$283.98	\$304.70	60"	50CM	Custom Len.	

Cable Assemblies

See Our Website For Current Pricing & Real-Time Stock Availability!

For Custom Lengths, Metric Lengths or Special Configurations, Please call (949) 261-1920



Technical Support  
+1 (949) 261-1920



Same-Day Shipping,  
Even Custom Cable Assemblies

For our complete selection of cable assemblies, please visit our website

Cable Assemblies  
See Our Website For Current Pricing & Real-Time Stock Availability!

LMR-240-UF Coax, 50 Ohm						
Part No. <a href="#">PE3W06417</a>	Cable Dia.			Attn. @ 1 GHz	Power @ 1 GHz	
1 piece price shown. See web or call for volume pricing.	0.240" dia.			9 dB/100ft	W	28
12"	24"	36"	48"	60"	50CM	Custom Len.
\$53.51	\$54.85	\$56.20	\$57.55	\$58.90	\$54.37	See Web
Low PIM Corrugated Cable Assemblies						
SPP-250-LLPL Coax, 50 Ohm						
Part No. <a href="#">PE3C5892</a>	Cable Dia.			Attn. @ 1 GHz	Power @ 1 GHz	
1 piece price shown. See web or call for volume pricing.	0.280" dia.			dB/100ft	W	29
12"	24"	36"	48"	60"	50CM	Custom Len.
\$69.63	\$75.21	\$80.79	\$86.37	\$91.95	\$73.21	See Web
N MALE TO SMA FEMALE						
Low Loss Flexible Cable Assemblies						
PE-P142LL Coax, 50 Ohm						
Part No. <a href="#">PE3C1128</a>	Cable Dia.			Attn. @ 1 GHz	Power @ 1 GHz	
1 piece price shown. See web or call for volume pricing.	0.195" dia.			10 dB/100ft	W	30
12"	24"	36"	48"	60"	50CM	Custom Len.
\$157.67	\$173.90	\$190.14	\$206.38	\$222.62	\$168.08	See Web
Low PIM Corrugated Cable Assemblies						
SPP-250-LLPL Coax, 50 Ohm						
Part No. <a href="#">PE3C5881</a>	Cable Dia.			Attn. @ 1 GHz	Power @ 1 GHz	
1 piece price shown. See web or call for volume pricing.	0.280" dia.			dB/100ft	W	31
12"	24"	36"	48"	60"	50CM	Custom Len.
\$68.91	\$74.49	\$80.07	\$85.64	\$91.22	\$72.48	See Web
Standard Flexible Cable Assemblies						
PE-FF430 Coax, 50 Ohm						
Part No. <a href="#">PE3C4009</a>	Cable Dia.			Attn. @ 1 GHz	Power @ 1 GHz	
1 piece price shown. See web or call for volume pricing.	0.430" dia.			dB/100ft	W	32
60"	-	-	-	-	-	Custom Len.
\$689.65	-	-	-	-	-	See Web
PE-VNA-R Coax, 50 Ohm						
Part No. <a href="#">PE3VNA1806</a>	Cable Dia.			Attn. @ 1 GHz	Power @ 1 GHz	
1 piece price shown. See web or call for volume pricing.	0.430" dia.			dB/100ft	W	33
24"	36"	48"	-	-	-	Custom Len.
\$870.00	\$918.70	\$967.40	-	-	-	See Web
N MALE TO SMA FEMALE BULKHEAD						
SEE MOUNTING HOLE SECTION ON PAGE 369						
Low Loss Flexible Cable Assemblies						
PE-P160LL Coax, 50 Ohm						
Part No. <a href="#">PE3C5277</a>	Cable Dia.			Attn. @ 1 GHz	Power @ 1 GHz	
1 piece price shown. See web or call for volume pricing.	0.160" dia.			dB/100ft	W	34
12"	24"	36"	48"	60"	50CM	Custom Len.
\$222.45	\$243.17	\$263.87	\$284.59	\$305.30	\$235.72	See Web
N MALE TO SSMC PLUG						
Flexible Cable Assemblies						
RG316/U Coax, 50 Ohm						
Part No. <a href="#">PE3C4415</a>	Cable Dia.			Attn. @ 1 GHz	Power @ 1 GHz	
1 piece price shown. See web or call for volume pricing.	0.098" dia.			58 dB/100ft	160 W	35
6"	12"	18"	24"	36"	48"	Custom Len.
\$61.68	\$63.08	\$64.49	\$65.87	\$68.69	\$71.48	See Web
Low Loss Flexible Cable Assemblies						
LMR-100A-PVC Coax, 50 Ohm						
Part No. <a href="#">PE3C4432</a>	Cable Dia.			Attn. @ 1 GHz	Power @ 1 GHz	
1 piece price shown. See web or call for volume pricing.	0.110" dia.			24 dB/100ft	W	36
6"	12"	18"	24"	36"	48"	Custom Len.
\$51.09	\$51.46	\$56.99	\$52.20	\$52.94	\$53.67	See Web
Standard Formable Cable Assemblies						
PE-SR405FLJ Coax, 50 Ohm						
Part No. <a href="#">PE3C4451</a>	Cable Dia.			Attn. @ 1 GHz	Power @ 1 GHz	
1 piece price shown. See web or call for volume pricing.	0.105" dia.			20 dB/100ft	122 W	37
6"	12"	18"	24"	36"	48"	Custom Len.
\$63.02	\$66.79	\$70.55	\$74.31	\$81.83	\$89.35	See Web
Standard Flexible Cable Assemblies						
RG178B/U Coax, 50 Ohm						
Part No. <a href="#">PE3C4399</a>	Cable Dia.			Attn. @ 1 GHz	Power @ 1 GHz	
1 piece price shown. See web or call for volume pricing.	0.072" dia.			44 dB/100ft	55 W	38
6"	12"	18"	24"	36"	48"	Custom Len.
\$73.58	\$74.06	\$74.53	\$74.98	\$75.92	\$76.85	See Web
N MALE TO SSMC PLUG RIGHT ANGLE						

Standard Flexible Cable Assemblies						
RG316/U Coax, 50 Ohm						
Part No. <a href="#">PE3C4416</a>	Cable Dia.			Attn. @ 1 GHz	Power @ 1 GHz	
1 piece price shown. See web or call for volume pricing.	0.098" dia.			58 dB/100ft	160 W	39
6"	12"	18"	24"	36"	48"	Custom Len.
\$58.24	\$59.65	\$61.05	\$62.44	\$65.26	\$68.04	See Web
N MALE TO SSMC JACK BULKHEAD						
SEE MOUNTING HOLE SECTION ON PAGE 369						
Standard Flexible Cable Assemblies						
RG178B/U Coax, 50 Ohm						
Part No. <a href="#">PE3C4400</a>	Cable Dia.			Attn. @ 1 GHz	Power @ 1 GHz	
1 piece price shown. See web or call for volume pricing.	0.072" dia.			44 dB/100ft	55 W	40
6"	12"	18"	24"	36"	48"	Custom Len.
\$69.61	\$70.08	\$70.55	\$78.14	\$71.95	\$72.88	See Web
N MALE TO TNC MALE						
Low Loss Flexible Cable Assemblies						
PE-C195 Coax, 50 Ohm						
Part No. <a href="#">PE35785</a>	Cable Dia.			Attn. @ 1 GHz	Power @ 1 GHz	
1 piece price shown. See web or call for volume pricing.	0.195" dia.			11 dB/100ft	150 W	41
12"	24"	36"	48"	60"	-	Custom Len.
\$37.82	\$38.54	\$41.65	\$42.47	\$43.27	-	See Web
PE-C200 Coax, 50 Ohm						
Part No. <a href="#">PE36067</a>	Cable Dia.			Attn. @ 1 GHz	Power @ 1 GHz	
1 piece price shown. See web or call for volume pricing.	0.195" dia.			11 dB/100ft	170 W	42
12"	24"	36"	48"	60"	-	Custom Len.
\$54.23	\$55.35	\$59.62	\$63.83	\$57.63	-	See Web
PE-C240 Coax, 50 Ohm						
Part No. <a href="#">PE36958</a>	Cable Dia.			Attn. @ 1 GHz	Power @ 1 GHz	
1 piece price shown. See web or call for volume pricing.	0.240" dia.			9 dB/100ft	250 W	43
12"	24"	36"	48"	60"	-	Custom Len.
\$49.43	\$54.52	\$55.65	\$56.84	\$58.01	-	See Web
PE-C300 Coax, 50 Ohm						
Part No. <a href="#">PE37980</a>	Cable Dia.			Attn. @ 1 GHz	Power @ 1 GHz	
1 piece price shown. See web or call for volume pricing.	0.300" dia.			6 dB/100ft	350 W	44
12"	24"	36"	48"	60"	-	Custom Len.
\$59.44	\$62.28	\$65.10	\$67.94	\$70.78	-	See Web
PE-C400 Coax, 50 Ohm						
Part No. <a href="#">PE34801</a>	Cable Dia.			Attn. @ 1 GHz	Power @ 1 GHz	
1 piece price shown. See web or call for volume pricing.	0.400" dia.			4 dB/100ft	550 W	45
12"	24"	36"	48"	60"	-	Custom Len.
\$71.09	\$72.41	\$76.66	\$79.90	\$86.27	-	See Web
LMR-400 Coax, 50 Ohm						
Part No. <a href="#">PE3W00013</a>	Cable Dia.			Attn. @ 1 GHz	Power @ 1 GHz	
1 piece price shown. See web or call for volume pricing.	0.405" dia.			dB/100ft	W	46
12"	24"	36"	48"	60"	50CM	Custom Len.
\$49.20	\$50.54	\$51.88	\$53.22	\$54.56	\$50.06	See Web
PE-C0031						
Part No. <a href="#">PE3C0031</a>	Cable Dia.			Attn. @ 1 GHz	Power @ 1 GHz	
1 piece price shown. See web or call for volume pricing.	0.405" dia.			4 dB/100ft	W	47
12"	24"	36"	48"	60"	-	Custom Len.
\$63.63	\$65.00	\$66.38	\$67.85	\$69.25	-	See Web
PE-C0109						
Part No. <a href="#">PE3C0109</a>	Cable Dia.			Attn. @ 1 GHz	Power @ 1 GHz	
1 piece price shown. See web or call for volume pricing.	0.405" dia.			4 dB/100ft	W	48
12"	24"	36"	48"	60"	-	Custom Len.
\$67.92	\$73.37	\$74.76	\$72.03	\$73.39	-	See Web
PE-P142LL Coax, 50 Ohm						
Part No. <a href="#">PE349</a>	Cable Dia.			Attn. @ 1 GHz	Power @ 1 GHz	
1 piece price shown. See web or call for volume pricing.	0.195" dia.			7 dB/100ft	820 W	49
12"	24"	36"	48"	60"	72"	Custom Len.
\$149.50	\$166.03	\$182.55	\$199.09	\$215.61	\$232.13	See Web
PE-P160LL Coax, 50 Ohm						
Part No. <a href="#">PE3C5267</a>	Cable Dia.			Attn. @ 1 GHz	Power @ 1 GHz	
1 piece price shown. See web or call for volume pricing.	0.160" dia.			dB/100ft	W	50
12"	24"	36"	48"	60"	50CM	Custom Len.
\$205.44	\$226.16	\$246.87	\$267.58	\$288.29	\$218.71	See Web
Low Loss Test Flexible Cable Assemblies						
PE-P300LL Coax, 50 Ohm						
Part No. <a href="#">PE335</a>	Cable Dia.			Attn. @ 1 GHz	Power @ 1 GHz	
1 piece price shown. See web or call for volume pricing.	0.300" dia.			5 dB/100ft	W	51
12"	24"	36"	48"	60"	50CM	Custom Len.
\$225.09	\$251.02	\$276.97	\$302.91	\$328.83	\$241.71	See Web
Standard Formable Cable Assemblies						
PE-SR402FL Coax, 50 Ohm						
Part No. <a href="#">PE33927</a>	Cable Dia.			Attn. @ 1 GHz	Power @ 1 GHz	
1 piece price shown. See web or call for volume pricing.	* dia.			12 dB/100ft	450 W	52
12"	24"	36"	48"	60"	-	Custom Len.
\$81.71	\$89.25	\$96.78	\$104.33	\$111.86	-	See Web
Standard Flexible Cable Assemblies						

\*Coax Performance at 1 GHz Notes: Cable assembly max frequency may be lower than connector or coax max frequency



# For our complete selection of cable assemblies, please visit our website

RG8A/U Coax, 50 Ohm						
Part No. <b>PE33615</b>	Cable Dia.	Attn. @ 1 GHz	Power @ 1 GHz			
1 piece price shown. See web or call for volume pricing.						
12"	24"	36"	48"	60"	72"	Custom Len.
\$69.34	\$72.41	\$71.08	\$73.91	\$76.75	\$85.00	See Web
RG8X Coax, 50 Ohm						
Part No. <b>PE37357</b>	Cable Dia.	Attn. @ 1 GHz	Power @ 1 GHz			
1 piece price shown. See web or call for volume pricing.						
12"	24"	36"	48"	60"	-	Custom Len.
\$59.97	\$67.10	\$65.62	\$68.44	\$71.27	-	See Web
RG58C/U Coax, 50 Ohm						
Part No. <b>PE3661</b>	Cable Dia.	Attn. @ 1 GHz	Power @ 1 GHz			
1 piece price shown. See web or call for volume pricing.						
12"	24"	36"	48"	60"	72"	Custom Len.
\$44.33	\$45.14	\$45.95	\$46.82	\$44.76	\$48.48	See Web
RG142B/U Coax, 50 Ohm						
Part No. <b>PE3652</b>	Cable Dia.	Attn. @ 1 GHz	Power @ 1 GHz			
1 piece price shown. See web or call for volume pricing.						
12"	24"	36"	48"	60"	72"	Custom Len.
\$48.33	\$54.41	\$60.49	\$66.92	\$73.12	\$79.32	See Web
RG174A/U Coax, 50 Ohm						
Part No. <b>PE34272</b>	Cable Dia.	Attn. @ 1 GHz	Power @ 1 GHz			
1 piece price shown. See web or call for volume pricing.						
12"	24"	36"	48"	60"	72"	Custom Len.
\$57.98	\$58.41	\$58.85	\$59.29	\$59.72	\$60.16	See Web
RG178B/U Coax, 50 Ohm						
Part No. <b>PE33455</b>	Cable Dia.	Attn. @ 1 GHz	Power @ 1 GHz			
1 piece price shown. See web or call for volume pricing.						
12"	24"	36"	48"	60"	72"	Custom Len.
\$69.64	\$70.59	\$71.57	\$72.52	\$73.49	\$79.22	See Web
RG188A/U Coax, 50 Ohm						
Part No. <b>PE33457</b>	Cable Dia.	Attn. @ 1 GHz	Power @ 1 GHz			
1 piece price shown. See web or call for volume pricing.						
12"	24"	36"	48"	60"	72"	Custom Len.
\$59.87	\$62.08	\$64.30	\$66.53	\$68.74	\$70.96	See Web
RG213/U Coax, 50 Ohm						
Part No. <b>PE3644</b>	Cable Dia.	Attn. @ 1 GHz	Power @ 1 GHz			
1 piece price shown. See web or call for volume pricing.						
12"	24"	36"	48"	60"	72"	Custom Len.
\$58.34	\$65.92	\$67.59	\$69.25	\$70.91	\$72.56	See Web
RG214/U Coax, 50 Ohm						
Part No. <b>PE3991</b>	Cable Dia.	Attn. @ 1 GHz	Power @ 1 GHz			
1 piece price shown. See web or call for volume pricing.						
12"	24"	36"	48"	60"	72"	Custom Len.
\$80.39	\$92.99	\$95.05	\$102.38	\$109.70	\$124.87	See Web
RG223/U Coax, 50 Ohm						
Part No. <b>PE3665</b>	Cable Dia.	Attn. @ 1 GHz	Power @ 1 GHz			
1 piece price shown. See web or call for volume pricing.						
12"	24"	36"	48"	60"	72"	Custom Len.
\$47.31	\$50.41	\$53.53	\$56.82	\$56.22	\$63.17	See Web
RG316/U Coax, 50 Ohm						
Part No. <b>PE3989</b>	Cable Dia.	Attn. @ 1 GHz	Power @ 1 GHz			
1 piece price shown. See web or call for volume pricing.						
12"	24"	36"	48"	60"	72"	Custom Len.
\$65.61	\$68.74	\$71.86	\$69.42	\$72.30	\$75.19	See Web
RG316-DS Coax, 50 Ohm						
Part No. <b>PE34266</b>	Cable Dia.	Attn. @ 1 GHz	Power @ 1 GHz			
1 piece price shown. See web or call for volume pricing.						
12"	24"	36"	48"	60"	72"	Custom Len.
\$60.70	\$63.61	\$66.52	\$69.43	\$72.34	\$75.24	See Web
RG393/U Coax, 50 Ohm						
Part No. <b>PE3982</b>	Cable Dia.	Attn. @ 1 GHz	Power @ 1 GHz			
1 piece price shown. See web or call for volume pricing.						
12"	24"	36"	48"	60"	72"	Custom Len.
\$87.62	\$103.08	\$118.55	\$134.01	\$149.48	\$164.95	See Web
RG400/U Coax, 50 Ohm						
Part No. <b>PE3666</b>	Cable Dia.	Attn. @ 1 GHz	Power @ 1 GHz			
1 piece price shown. See web or call for volume pricing.						
12"	24"	36"	48"	60"	72"	Custom Len.
\$58.61	\$66.01	\$73.39	\$81.23	\$88.76	\$96.30	See Web
PE-FF430 Coax, 50 Ohm						
Part No. <b>PE3C4010</b>	Cable Dia.	Attn. @ 1 GHz	Power @ 1 GHz			
1 piece price shown. See web or call for volume pricing.						
60"	-	-	-	-	-	Custom Len.
\$964.95	-	-	-	-	-	See Web
LMR-600-DB Coax, 50 Ohm						
Part No. <b>PE3W02356</b>	Cable Dia.	Attn. @ 1 GHz	Power @ 1 GHz			
1 piece price shown. See web or call for volume pricing.						
12"	24"	36"	48"	60"	50CM	Custom Len.
\$75.12	\$78.08	\$81.04	\$84.00	\$86.96	\$77.02	See Web

## Standard Semi-Rigid Cable Assemblies

### PE-SR402AL Coax, 50 Ohm

Part No. <b>PE3W05401</b>	Cable Dia.	Attn. @ 1 GHz	Power @ 1 GHz			
1 piece price shown. See web or call for volume pricing.						
12"	24"	36"	48"	60"	50CM	Custom Len.
\$79.04	\$88.92	\$98.80	\$108.68	\$118.56	\$85.36	See Web
RG401/U Coax, 50 Ohm						
Part No. <b>PE3W05651</b>	Cable Dia.	Attn. @ 1 GHz	Power @ 1 GHz			
1 piece price shown. See web or call for volume pricing.						
12"	24"	36"	48"	60"	50CM	Custom Len.
\$127.32	\$150.37	\$173.43	\$196.49	\$219.54	\$142.09	See Web
RG402/U Coax, 50 Ohm						
Part No. <b>PE3080</b>	Cable Dia.	Attn. @ 1 GHz	Power @ 1 GHz			
1 piece price shown. See web or call for volume pricing.						
12"	24"	36"	48"	60"	-	Custom Len.
\$86.22	\$94.04	\$95.94	\$103.25	\$110.54	-	See Web
N MALE TO TNC MALE RIGHT ANGLE						
Low Loss Flexible Cable Assemblies						
LMR-200 Coax, 50 Ohm						
Part No. <b>PE3W02215</b>	Cable Dia.	Attn. @ 1 GHz	Power @ 1 GHz			
1 piece price shown. See web or call for volume pricing.						
12"	24"	36"	48"	60"	50CM	Custom Len.
\$52.40	\$53.19	\$53.98	\$54.77	\$55.56	\$52.91	See Web
PE-P160LL Coax, 50 Ohm						
Part No. <b>PE3C5268</b>	Cable Dia.	Attn. @ 1 GHz	Power @ 1 GHz			
1 piece price shown. See web or call for volume pricing.						
12"	24"	36"	48"	60"	50CM	Custom Len.
\$264.21	\$284.92	\$305.63	\$326.35	\$347.06	\$277.48	See Web
N MALE TO TNC FEMALE						
Standard Flexible Cable Assemblies						
PE-FF430 Coax, 50 Ohm						
Part No. <b>PE3C4011</b>	Cable Dia.	Attn. @ 1 GHz	Power @ 1 GHz			
1 piece price shown. See web or call for volume pricing.						
60"	-	-	-	-	-	Custom Len.
\$964.95	-	-	-	-	-	See Web
N MALE TO TNC FEMALE BULKHEAD						
SEE MOUNTING HOLE SECTION ON PAGE 369						
Low Loss Flexible Cable Assemblies						
PE-P142LL Coax, 50 Ohm						
Part No. <b>PE3C2276</b>	Cable Dia.	Attn. @ 1 GHz	Power @ 1 GHz			
1 piece price shown. See web or call for volume pricing.						
12"	24"	36"	48"	60"	50CM	Custom Len.
\$183.79	\$200.03	\$216.27	\$232.50	\$248.74	\$194.20	See Web
PE-P160LL Coax, 50 Ohm						
Part No. <b>PE3C5269</b>	Cable Dia.	Attn. @ 1 GHz	Power @ 1 GHz			
1 piece price shown. See web or call for volume pricing.						
12"	24"	36"	48"	60"	50CM	Custom Len.
\$231.73	\$252.45	\$273.15	\$293.87	\$314.58	\$245.00	See Web
N MALE TO REVERSE POLARITY TNC MALE						
Low Loss Flexible Cable Assemblies						
PE-C195 Coax, 50 Ohm						
Part No. <b>PE36362</b>	Cable Dia.	Attn. @ 1 GHz	Power @ 1 GHz			
1 piece price shown. See web or call for volume pricing.						
12"	24"	36"	48"	60"	-	Custom Len.
\$39.50	\$40.21	\$40.93	\$41.63	\$42.35	-	See Web
PE-C400 Coax, 50 Ohm						
Part No. <b>PE34966</b>	Cable Dia.	Attn. @ 1 GHz	Power @ 1 GHz			
1 piece price shown. See web or call for volume pricing.						
12"	24"	36"	48"	60"	-	Custom Len.
\$61.80	\$63.11	\$68.48	\$65.75	\$67.07	-	See Web
Standard Flexible Cable Assemblies						
RG58C/U Coax, 50 Ohm						
Part No. <b>PE34554</b>	Cable Dia.	Attn. @ 1 GHz	Power @ 1 GHz			
1 piece price shown. See web or call for volume pricing.						
12"	24"	36"	48"	60"	72"	Custom Len.
\$48.00	\$52.66	\$49.47	\$50.20	\$50.94	\$51.68	See Web
RG223/U Coax, 50 Ohm						
Part No. <b>PE35245</b>	Cable Dia.	Attn. @ 1 GHz	Power @ 1 GHz			
1 piece price shown. See web or call for volume pricing.						
12"	24"	36"	48"	60"	72"	Custom Len.
\$42.58	\$45.46	\$51.36	\$51.34	\$54.22	\$57.16	See Web

Cable Assemblies

See Our Website For Current Pricing & Real-Time Stock Availability!

For Custom Lengths, Metric Lengths or Special Configurations, Please call (949) 261-1920



Technical Support  
+1 (949) 261-1920



Same-Day Shipping,  
Even Custom Cable Assemblies

For our complete selection of cable assemblies, please visit our website

RG316/U Coax, 50 Ohm				
Part No. <a href="#">PE35247</a>	Cable Dia.	Attn. @ 1 GHz	Power @ 1 GHz	81
1 piece price shown. See web or call for volume pricing.	0.098" dia.	38 dB/100ft	160 W	
12" 24" 36" 48"	60"	72"	Custom Len.	
\$62.31 \$65.20 \$68.10 \$70.98	\$73.86	\$76.75	See Web	
Standard Flexible Cable Assemblies				
RG400/U Coax, 50 Ohm				
Part No. <a href="#">PE34626</a>	Cable Dia.	Attn. @ 1 GHz	Power @ 1 GHz	82
1 piece price shown. See web or call for volume pricing.	0.195" dia.	15 dB/100ft	650 W	
12" 24" 36" 48"	60"	-	Custom Len.	
\$55.82 \$68.79 \$76.19 \$84.01	\$91.55	-	See Web	
Standard Flexible Cable Assemblies				
RG178B/U Coax, 50 Ohm				
Part No. <a href="#">PE36283</a>	Cable Dia.	Attn. @ 1 GHz	Power @ 1 GHz	83
1 piece price shown. See web or call for volume pricing.	0.195" dia.	15 dB/100ft	650 W	
12" 24" 36" 48"	60"	-	Custom Len.	
\$67.60 \$74.57 \$81.53 \$94.27	\$95.47	-	See Web	
Standard Flexible Cable Assemblies				
N MALE TO REVERSE POLARITY TNC MALE RIGHT ANGLE				
Standard Flexible Cable Assemblies				
RG400/U Coax, 50 Ohm				
Part No. <a href="#">PE36283</a>	Cable Dia.	Attn. @ 1 GHz	Power @ 1 GHz	83
1 piece price shown. See web or call for volume pricing.	0.195" dia.	15 dB/100ft	650 W	
12" 24" 36" 48"	60"	-	Custom Len.	
\$67.60 \$74.57 \$81.53 \$94.27	\$95.47	-	See Web	
Standard Flexible Cable Assemblies				
N MALE TO UMCX PLUG RIGHT ANGLE				
Standard Flexible Cable Assemblies				
RG178B/U Coax, 50 Ohm				
Part No. <a href="#">PE38813</a>	Cable Dia.	Attn. @ 1 GHz	Power @ 1 GHz	84
1 piece price shown. See web or call for volume pricing.	0.072" dia.	44 dB/100ft	78 W	
3" 6" 9" 12"	18"	24"	Custom Len.	
\$71.47 \$71.47 \$71.47 \$75.76	\$76.29	\$72.43	See Web	
Standard Flexible Cable Assemblies				
N MALE RIGHT ANGLE TO BNC MALE				
Standard Flexible Cable Assemblies				
RG400/U Coax, 50 Ohm				
Part No. <a href="#">PE3W06095</a>	Cable Dia.	Attn. @ 1 GHz	Power @ 1 GHz	85
1 piece price shown. See web or call for volume pricing.	0.195" dia.	15 dB/100ft	600 W	
12" 24" 36" 48"	60"	50CM	Custom Len.	
\$62.48 \$70.08 \$77.70 \$85.31	\$92.93	\$67.35	See Web	
Standard Flexible Cable Assemblies				
N MALE RIGHT ANGLE TO N MALE				
Flexible Cable Assemblies				
LMR-195 Coax, 50 Ohm				
Part No. <a href="#">PE3C0120</a>	Cable Dia.	Attn. @ 1 GHz	Power @ 1 GHz	86
1 piece price shown. See web or call for volume pricing.	0.195" dia.	12 dB/100ft	W	
12" 24" 36" 48"	60"	-	Custom Len.	
\$50.04 \$47.94 \$51.53 \$49.44	\$50.18	-	See Web	
Low PIM Corrugated Cable Assemblies				
SPP-250-LLPL Coax, 50 Ohm				
Part No. <a href="#">PE3C4139</a>	Cable Dia.	Attn. @ 1 GHz	Power @ 1 GHz	87
1 piece price shown. See web or call for volume pricing.	0.280" dia.	dB/100ft	W	
12" 24" 36" 48"	60"	50CM	Custom Len.	
\$90.51 \$96.09 \$101.67 \$107.25	\$112.83	\$94.08	See Web	
Low Loss Formable Cable Assemblies				
LMR-SW396 Coax, 50 Ohm				
Part No. <a href="#">PE3C0140</a>	Cable Dia.	Attn. @ 1 GHz	Power @ 1 GHz	88
1 piece price shown. See web or call for volume pricing.	0.450" dia.	3 dB/100ft	W	
12" 24" 36" 48"	60"	-	Custom Len.	
\$83.98 \$86.27 \$88.54 \$90.82	\$98.66	-	See Web	
Low Loss Flexible Cable Assemblies				
PE-C195 Coax, 50 Ohm				
Part No. <a href="#">PE36910</a>	Cable Dia.	Attn. @ 1 GHz	Power @ 1 GHz	89
1 piece price shown. See web or call for volume pricing.	0.195" dia.	11 dB/100ft	150 W	
12" 24" 36" 48"	60"	-	Custom Len.	
\$65.68 \$71.71 \$72.49 \$67.83	\$68.53	-	See Web	
Standard Flexible Cable Assemblies				
PE-C240 Coax, 50 Ohm				
Part No. <a href="#">PE38699</a>	Cable Dia.	Attn. @ 1 GHz	Power @ 1 GHz	90
1 piece price shown. See web or call for volume pricing.	0.240" dia.	9 dB/100ft	250 W	
36" 48" 60" 72"	120"	-	Custom Len.	
\$85.56 \$86.53 \$87.50 \$89.15	\$100.37	-	See Web	
Standard Flexible Cable Assemblies				
PE-C400 Coax, 50 Ohm				

Part No. <a href="#">PE38194</a>	Cable Dia.	Attn. @ 1 GHz	Power @ 1 GHz	91
1 piece price shown. See web or call for volume pricing.	0.400" dia.	4 dB/100ft	550 W	
36" 48" 60" 72"	120"	-	Custom Len.	
\$115.02 \$116.59 \$118.10 \$116.64	\$135.84	-	See Web	
LMR-400 Coax, 50 Ohm				
Part No. <a href="#">PE3C0107</a>	Cable Dia.	Attn. @ 1 GHz	Power @ 1 GHz	92
1 piece price shown. See web or call for volume pricing.	0.405" dia.	4 dB/100ft	W	
12" 24" 36" 48"	60"	-	Custom Len.	
\$80.30 \$81.68 \$85.48 \$86.93	\$85.79	-	See Web	
LMR-195 Coax, 50 Ohm				
Part No. <a href="#">PE3C0119</a>	Cable Dia.	Attn. @ 1 GHz	Power @ 1 GHz	93
1 piece price shown. See web or call for volume pricing.	0.195" dia.	12 dB/100ft	W	
12" 24" 36" 48"	60"	-	Custom Len.	
\$51.17 \$51.93 \$52.68 \$51.93	\$52.68	-	See Web	
PE-P142LL Coax, 50 Ohm				
Part No. <a href="#">PE3C0967</a>	Cable Dia.	Attn. @ 1 GHz	Power @ 1 GHz	94
1 piece price shown. See web or call for volume pricing.	0.195" dia.	10 dB/100ft	W	
12" 24" 36" 48"	60"	50CM	Custom Len.	
\$325.84 \$342.08 \$358.30 \$374.54	\$390.78	\$336.24	See Web	
PE-P142LL-27478 Coax, 50 Ohm				
Part No. <a href="#">PE3M0179</a>	Cable Dia.	Attn. @ 1 GHz	Power @ 1 GHz	95
1 piece price shown. See web or call for volume pricing.	0.195" dia.	dB/100ft	W	
12" 18" 24" 36"	48"	60"	Custom Len.	
\$600.12 \$608.59 \$617.07 \$634.03	\$650.99	\$667.94	See Web	
PE-P160LL-27478 Coax, 50 Ohm				
Part No. <a href="#">PE3M0224</a>	Cable Dia.	Attn. @ 1 GHz	Power @ 1 GHz	96
1 piece price shown. See web or call for volume pricing.	0.160" dia.	dB/100ft	W	
8" 12" 18" 24"	36"	36"	Custom Len.	
\$536.74 \$541.64 \$549.00 \$556.34	\$563.70	\$571.04	See Web	
PE-P300LL-27478 Coax, 50 Ohm				
Part No. <a href="#">PE3M0252</a>	Cable Dia.	Attn. @ 1 GHz	Power @ 1 GHz	97
1 piece price shown. See web or call for volume pricing.	0.300" dia.	dB/100ft	W	
12" 18" 24" 36"	48"	60"	Custom Len.	
\$707.94 \$722.09 \$736.25 \$764.55	\$792.85	\$821.15	See Web	
PE-P160LL Coax, 50 Ohm				
Part No. <a href="#">PE3C5287</a>	Cable Dia.	Attn. @ 1 GHz	Power @ 1 GHz	98
1 piece price shown. See web or call for volume pricing.	0.160" dia.	dB/100ft	W	
12" 24" 36" 48"	60"	50CM	Custom Len.	
\$322.97 \$343.69 \$364.40 \$385.11	\$405.82	\$336.24	See Web	
Low PIM Corrugated Cable Assemblies				
SPP-250-LLPL Coax, 50 Ohm				
Part No. <a href="#">PE3C4145</a>	Cable Dia.	Attn. @ 1 GHz	Power @ 1 GHz	99
1 piece price shown. See web or call for volume pricing.	0.280" dia.	dB/100ft	650 W	
12" 24" 36" 48"	60"	50CM	Custom Len.	
\$93.32 \$98.90 \$104.48 \$110.06	\$115.64	\$96.90	See Web	
Low Loss Test Flexible Cable Assemblies				
PE-P300LL Coax, 50 Ohm				
Part No. <a href="#">PE3C3233</a>	Cable Dia.	Attn. @ 1 GHz	Power @ 1 GHz	1
1 piece price shown. See web or call for volume pricing.	0.300" dia.	6 dB/100ft	W	
12" 24" 36" 48"	60"	50CM	Custom Len.	
\$338.49 \$364.42 \$390.36 \$416.30	\$442.23	\$355.10	See Web	
Standard Formable Cable Assemblies				
PE-SR401FL Coax, 50 Ohm				
Part No. <a href="#">PE34680</a>	Cable Dia.	Attn. @ 1 GHz	Power @ 1 GHz	2
1 piece price shown. See web or call for volume pricing.	" dia.	8 dB/100ft	1400 W	
12" 24" 36" 48"	60"	-	Custom Len.	
\$115.08 \$123.95 \$139.36 \$154.76	\$170.17	-	See Web	
PE-SR402FL Coax, 50 Ohm				
Part No. <a href="#">PE39452</a>	Cable Dia.	Attn. @ 1 GHz	Power @ 1 GHz	3
1 piece price shown. See web or call for volume pricing.	" dia.	12 dB/100ft	400 W	
6" 9" 12" 18"	24"	-	Custom Len.	
\$76.73 \$78.69 \$80.65 \$78.23	\$82.00	-	See Web	
PE-SR402FL Coax, 50 Ohm				
Part No. <a href="#">PE33977</a>	Cable Dia.	Attn. @ 1 GHz	Power @ 1 GHz	4
1 piece price shown. See web or call for volume pricing.	" dia.	12 dB/100ft	450 W	
12" 24" 36" 48"	60"	-	Custom Len.	
\$76.29 \$83.85 \$91.38 \$98.91	\$106.46	-	See Web	
PE-SR402FL Coax, 50 Ohm				
Part No. <a href="#">PE39466</a>	Cable Dia.	Attn. @ 1 GHz	Power @ 1 GHz	5
1 piece price shown. See web or call for volume pricing.	0.161" dia.	12 dB/100ft	303 W	
6" 9" 12" 18"	24"	-	Custom Len.	
\$76.80 \$76.80 \$76.80 \$80.58	\$84.36	-	See Web	
Standard Flexible Cable Assemblies				
RG8A/U Coax, 50 Ohm				
Part No. <a href="#">PE33974</a>	Cable Dia.	Attn. @ 1 GHz	Power @ 1 GHz	6
1 piece price shown. See web or call for volume pricing.	0.405" dia.	8 dB/100ft	190 W	
12" 24" 36" 48"	60"	72"	Custom Len.	
\$108.29 \$111.36 \$114.44 \$112.63	\$115.45	\$123.95	See Web	
RG58C/U Coax, 50 Ohm				
Part No. <a href="#">PE3698</a>	Cable Dia.	Attn. @ 1 GHz	Power @ 1 GHz	7
1 piece price shown. See web or call for volume pricing.	0.195" dia.	20 dB/100ft	44 W	
12" 24" 36" 48"	60"	72"	Custom Len.	
\$78.92 \$75.19 \$80.55 \$76.67	\$77.41	\$83.07	See Web	

\*Coax Performance at 1 GHz Notes: Cable assembly max frequency may be lower than connector or coax max frequency

# For our complete selection of cable assemblies, please visit our website

RG174/U Coax, 50 Ohm						
Part No. <a href="#">PE34231</a>	Cable Dia.	Attn. @ 1 GHz	Power @ 1 GHz			
1 piece price shown. See web or call for volume pricing.						
12"	24"	36"	48"	60"	72"	Custom Len.
\$70.65	\$71.14	\$71.57	\$72.03	\$72.47	\$72.88	See Web
RG188A/U Coax, 50 Ohm						
Part No. <a href="#">PE34238</a>	Cable Dia.	Attn. @ 1 GHz	Power @ 1 GHz			
1 piece price shown. See web or call for volume pricing.						
12"	24"	36"	48"	60"	72"	Custom Len.
\$84.44	\$78.98	\$89.43	\$83.42	\$85.64	\$87.86	See Web
RG213/U Coax, 50 Ohm						
Part No. <a href="#">PE3272</a>	Cable Dia.	Attn. @ 1 GHz	Power @ 1 GHz			
1 piece price shown. See web or call for volume pricing.						
12"	24"	36"	48"	60"	72"	Custom Len.
\$107.11	\$102.71	\$104.37	\$112.58	\$107.69	\$109.35	See Web
RG214/U Coax, 50 Ohm						
Part No. <a href="#">PE3781</a>	Cable Dia.	Attn. @ 1 GHz	Power @ 1 GHz			
1 piece price shown. See web or call for volume pricing.						
12"	24"	36"	48"	60"	72"	Custom Len.
\$120.95	\$135.98	\$135.60	\$142.92	\$159.93	\$167.86	See Web
RG223/U Coax, 50 Ohm						
Part No. <a href="#">PE3882</a>	Cable Dia.	Attn. @ 1 GHz	Power @ 1 GHz			
1 piece price shown. See web or call for volume pricing.						
12"	24"	36"	48"	60"	72"	Custom Len.
\$83.85	\$80.52	\$83.42	\$86.32	\$89.23	\$92.13	See Web
RG225/U Coax, 50 Ohm						
Part No. <a href="#">PE34222</a>	Cable Dia.	Attn. @ 1 GHz	Power @ 1 GHz			
1 piece price shown. See web or call for volume pricing.						
12"	24"	36"	48"	60"	72"	Custom Len.
\$142.62	\$175.21	\$207.80	\$265.84	\$272.97	\$305.56	See Web
RG316/U Coax, 50 Ohm						
Part No. <a href="#">PE34236</a>	Cable Dia.	Attn. @ 1 GHz	Power @ 1 GHz			
1 piece price shown. See web or call for volume pricing.						
12"	24"	36"	48"	60"	72"	Custom Len.
\$77.63	\$80.52	\$83.41	\$86.30	\$89.18	\$98.22	See Web
RG393/U Coax, 50 Ohm						
Part No. <a href="#">PE3268</a>	Cable Dia.	Attn. @ 1 GHz	Power @ 1 GHz			
1 piece price shown. See web or call for volume pricing.						
12"	24"	36"	48"	60"	72"	Custom Len.
\$115.81	\$139.16	\$155.57	\$172.93	\$189.65	\$206.38	See Web
RG400/U Coax, 50 Ohm						
Part No. <a href="#">PE3412</a>	Cable Dia.	Attn. @ 1 GHz	Power @ 1 GHz			
1 piece price shown. See web or call for volume pricing.						
12"	24"	36"	48"	60"	72"	Custom Len.
\$92.16	\$99.56	\$106.95	\$114.78	\$114.82	\$129.85	See Web
PE-P141EAM Coax, 50 Ohm						
Part No. <a href="#">PE3CA1049</a>	Cable Dia.	Attn. @ 1 GHz	Power @ 1 GHz			
1 piece price shown. See web or call for volume pricing.						
12"	24"	36"	50CM	100CM	-	Custom Len.
\$103.16	\$119.49	\$135.80	\$113.61	\$140.38	-	See Web

## N MALE RIGHT ANGLE TO N FEMALE



### Low Loss Test Flexible Cable Assemblies

#### PE-P300LL Coax, 50 Ohm

Part No. <a href="#">PE3C3115</a>	Cable Dia.	Attn. @ 1 GHz	Power @ 1 GHz			
1 piece price shown. See web or call for volume pricing.						
12"	24"	36"	48"	60"	50CM	Custom Len.
\$326.66	\$352.60	\$378.54	\$404.47	\$430.41	\$343.28	See Web

### Standard Flexible Cable Assemblies

#### RG400/U Coax, 50 Ohm

Part No. <a href="#">PE3W06096</a>	Cable Dia.	Attn. @ 1 GHz	Power @ 1 GHz			
1 piece price shown. See web or call for volume pricing.						
12"	24"	36"	48"	60"	50CM	Custom Len.
\$70.10	\$77.71	\$85.32	\$92.94	\$100.55	\$74.97	See Web

## N MALE RIGHT ANGLE TO N FEMALE BULKHEAD

SEE MOUNTING HOLE SECTION ON PAGE 369



### Flexible Cable Assemblies

#### LMR-400 Coax, 50 Ohm

Part No. <a href="#">PE3W03991</a>	Cable Dia.	Attn. @ 1 GHz	Power @ 1 GHz			
1 piece price shown. See web or call for volume pricing.						
12"	24"	36"	48"	60"	50CM	Custom Len.
\$73.26	\$74.51	\$75.75	\$77.00	\$78.25	\$74.06	See Web

### Low Loss Flexible Cable Assemblies

#### PE-P142LL Coax, 50 Ohm

Part No. <a href="#">PE3C0673</a>	Cable Dia.	Attn. @ 1 GHz	Power @ 1 GHz			
1 piece price shown. See web or call for volume pricing.						
12"	24"	36"	48"	60"	50CM	Custom Len.
\$263.75	\$279.51	\$295.26	\$311.02	\$326.78	\$273.85	See Web

#### PE-P160LL Coax, 50 Ohm

Part No. <a href="#">PE3C5286</a>	Cable Dia.	Attn. @ 1 GHz	Power @ 1 GHz			
1 piece price shown. See web or call for volume pricing.						
12"	24"	36"	48"	60"	50CM	Custom Len.
\$290.49	\$311.21	\$331.92	\$352.63	\$373.34	\$303.76	See Web

LMR-240-UJ Coax, 50 Ohm						
Part No. <a href="#">PE3W06441</a>	Cable Dia.	Attn. @ 1 GHz	Power @ 1 GHz			
1 piece price shown. See web or call for volume pricing.						
12"	24"	36"	48"	60"	50CM	Custom Len.
\$78.08	\$79.42	\$80.77	\$82.12	\$83.47	\$78.94	See Web

Low Loss Test Flexible Cable Assemblies						
PE-P300LL Coax, 50 Ohm						
Part No. <a href="#">PE3C2953</a>	Cable Dia.	Attn. @ 1 GHz	Power @ 1 GHz			
1 piece price shown. See web or call for volume pricing.						
12"	24"	36"	48"	60"	50CM	Custom Len.
\$350.26	\$375.44	\$400.63	\$425.80	\$451.27	\$366.40	See Web

Standard Formable Cable Assemblies						
PE-SR402FL Coax, 50 Ohm						
Part No. <a href="#">PE38670</a>	Cable Dia.	Attn. @ 1 GHz	Power @ 1 GHz			
1 piece price shown. See web or call for volume pricing.						
12"	24"	36"	48"	60"	-	Custom Len.
\$85.52	\$87.88	\$95.03	\$102.18	\$109.31	-	See Web

Standard Flexible Cable Assemblies						
RG58C/U Coax, 50 Ohm						
Part No. <a href="#">PE3407</a>	Cable Dia.	Attn. @ 1 GHz	Power @ 1 GHz			
1 piece price shown. See web or call for volume pricing.						
12"	24"	36"	48"	60"	72"	Custom Len.
\$71.22	\$72.03	\$67.42	\$68.16	\$68.90	\$69.63	See Web

RG142B/U Coax, 50 Ohm						
Part No. <a href="#">PE33021</a>	Cable Dia.	Attn. @ 1 GHz	Power @ 1 GHz			
1 piece price shown. See web or call for volume pricing.						
12"	24"	36"	48"	60"	72"	Custom Len.
\$72.85	\$74.45	\$80.20	\$85.93	\$97.65	\$97.39	See Web

RG213/U Coax, 50 Ohm						
Part No. <a href="#">PE33545</a>	Cable Dia.	Attn. @ 1 GHz	Power @ 1 GHz			
1 piece price shown. See web or call for volume pricing.						
12"	24"	36"	48"	60"	72"	Custom Len.
\$94.51	\$96.17	\$97.82	\$99.48	\$101.15	\$102.81	See Web

RG214/U Coax, 50 Ohm						
Part No. <a href="#">PE33178</a>	Cable Dia.	Attn. @ 1 GHz	Power @ 1 GHz			
1 piece price shown. See web or call for volume pricing.						
12"	24"	36"	48"	60"	72"	Custom Len.
\$87.88	\$95.27	\$102.65	\$110.03	\$117.42	\$124.79	See Web

RG223/U Coax, 50 Ohm						
Part No. <a href="#">PE33536</a>	Cable Dia.	Attn. @ 1 GHz	Power @ 1 GHz			
1 piece price shown. See web or call for volume pricing.						
12"	24"	36"	48"	60"	72"	Custom Len.
\$62.20	\$69.05	\$68.01	\$70.95	\$73.84	\$81.81	See Web

RG225/U Coax, 50 Ohm						
Part No. <a href="#">PE34221</a>	Cable Dia.	Attn. @ 1 GHz	Power @ 1 GHz			
1 piece price shown. See web or call for volume pricing.						
12"	24"	36"	48"	60"	72"	Custom Len.
\$113.10	\$145.69	\$178.27	\$210.85	\$243.44	\$276.02	See Web

RG393/U Coax, 50 Ohm						
Part No. <a href="#">PE33532</a>	Cable Dia.	Attn. @ 1 GHz	Power @ 1 GHz			
1 piece price shown. See web or call for volume pricing.						
12"	24"	36"	48"	60"	72"	Custom Len.
\$93.17	\$108.63	\$124.10	\$139.56	\$155.03	\$170.50	See Web

RG400/U Coax, 50 Ohm						
Part No. <a href="#">PE33528</a>	Cable Dia.	Attn. @ 1 GHz	Power @ 1 GHz			
1 piece price shown. See web or call for volume pricing.						
12"	24"	36"	48"	60"	72"	Custom Len.
\$76.63	\$83.60	\$94.48	\$102.31	\$104.50	\$111.47	See Web

N MALE RIGHT ANGLE TO SMA MALE						
Low Loss Flexible Cable Assemblies						
PE-P160LL Coax, 50 Ohm						
Part No. <a href="#">PE3C5279</a>	Cable Dia.	Attn. @ 1 GHz	Power @ 1 GHz			
1 piece price shown. See web or call for volume pricing.						
12"	24"	36"	48"	60"	50CM	Custom Len.
\$264.21	\$284.92	\$305.63	\$326.35	\$347.06	\$277.48	See Web

N MALE RIGHT ANGLE TO SMA MALE RIGHT ANGLE						
Low Loss Flexible Cable Assemblies						
PE-P160LL Coax, 50 Ohm						
Part No. <a href="#">PE3C5281</a>	Cable Dia.	Attn. @ 1 GHz	Power @ 1 GHz			
1 piece price shown. See web or call for volume pricing.						
12"	24"	36"	48"	60"	50CM	Custom Len.
\$301.32	\$322.04	\$342.75	\$363.45	\$384.17	\$314.59	See Web

Cable Assemblies

See Our Website For Current Pricing & Real-Time Stock Availability!

For Custom Lengths, Metric Lengths or Special Configurations, Please call (949) 261-1920



Technical Support  
+1 (949) 261-1920



Same-Day Shipping,  
Even Custom Cable Assemblies

For our complete selection of cable assemblies, please visit our website

Cable Assemblies

See Our Website For Current Pricing & Real-Time Stock Availability!

N MALE RIGHT ANGLE TO SMA FEMALE BULKHEAD						
SEE MOUNTING HOLE SECTION ON PAGE 369						
Low Loss Flexible Cable Assemblies						
PE-P160LL Coax, 50 Ohm						
Part No.	PE3C5280	Cable Dia.	Attn. @ 1 GHz	Power @ 1 GHz		
1 piece price shown. See web or call for volume pricing.						
12"	24"	36"	48"	60"	50CM	Custom Len.
\$281.22	\$301.93	\$322.64	\$343.35	\$364.07	\$294.48	See Web
N MALE RIGHT ANGLE TO TNC MALE						
Flexible Cable Assemblies						
LMR-600-DB Coax, 50 Ohm						
Part No.	PE3C4750	Cable Dia.	Attn. @ 1 GHz	Power @ 1 GHz		
1 piece price shown. See web or call for volume pricing.						
12"	24"	36"	48"	60"	50CM	Custom Len.
\$80.21	\$83.17	\$86.13	\$89.09	\$92.06	\$82.11	See Web
Low Loss Flexible Cable Assemblies						
PE-P160LL Coax, 50 Ohm						
Part No.	PE3C5282	Cable Dia.	Attn. @ 1 GHz	Power @ 1 GHz		
1 piece price shown. See web or call for volume pricing.						
12"	24"	36"	48"	60"	50CM	Custom Len.
\$264.21	\$284.92	\$305.63	\$326.35	\$347.06	\$277.48	See Web
Low Loss Test Flexible Cable Assemblies						
PE-P300LL Coax, 50 Ohm						
Part No.	PE3C3243	Cable Dia.	Attn. @ 1 GHz	Power @ 1 GHz		
1 piece price shown. See web or call for volume pricing.						
12"	24"	36"	48"	60"	50CM	Custom Len.
\$378.20	\$403.39	\$428.60	\$453.80	\$479.01	\$394.33	See Web
N MALE RIGHT ANGLE TO TNC MALE RIGHT ANGLE						
Low Loss Flexible Cable Assemblies						
LMR-195 Coax, 50 Ohm						
Part No.	PE3W00020	Cable Dia.	Attn. @ 1 GHz	Power @ 1 GHz		
1 piece price shown. See web or call for volume pricing.						
12"	24"	36"	48"	60"	50CM	Custom Len.
\$57.96	\$58.68	\$59.41	\$60.14	\$60.86	\$58.42	See Web
PE-P142LL Coax, 50 Ohm						
Part No.	PE3C1271	Cable Dia.	Attn. @ 1 GHz	Power @ 1 GHz		
1 piece price shown. See web or call for volume pricing.						
12"	24"	36"	48"	60"	50CM	Custom Len.
\$345.39	\$342.08	\$358.30	\$374.54	\$390.78	\$336.24	See Web
PE-P160LL Coax, 50 Ohm						
Part No.	PE3C5284	Cable Dia.	Attn. @ 1 GHz	Power @ 1 GHz		
1 piece price shown. See web or call for volume pricing.						
12"	24"	36"	48"	60"	50CM	Custom Len.
\$322.97	\$343.69	\$364.40	\$385.11	\$405.82	\$336.24	See Web
N MALE RIGHT ANGLE TO TNC FEMALE BULKHEAD						
SEE MOUNTING HOLE SECTION ON PAGE 369						
Low Loss Flexible Cable Assemblies						
PE-P160LL Coax, 50 Ohm						
Part No.	PE3C5283	Cable Dia.	Attn. @ 1 GHz	Power @ 1 GHz		
1 piece price shown. See web or call for volume pricing.						
12"	24"	36"	48"	60"	50CM	Custom Len.
\$290.49	\$311.21	\$331.92	\$352.63	\$373.34	\$303.76	See Web
N MALE RIGHT ANGLE TO UHF MALE						
Standard Flexible Cable Assemblies						
RG214/U Coax, 50 Ohm						
Part No.	PE38204	Cable Dia.	Attn. @ 1 GHz	Power @ 1 GHz		
1 piece price shown. See web or call for volume pricing.						
12"	24"	36"	48"	60"	-	Custom Len.
\$97.21	\$104.98	\$112.76	\$121.00	\$121.01	-	See Web
N FEMALE TO N FEMALE						
Standard Flexible Cable Assemblies						
M17/60-RG142-27478 Coax, 50 Ohm						

Part No.	PE3M0011	Cable Dia.	Attn. @ 1 GHz	Power @ 1 GHz		
1 piece price shown. See web or call for volume pricing.						
12"	18"	24"	30"	36"	48"	Custom Len.
\$171.13	\$173.86	\$176.59	\$179.31	\$182.04	\$187.50	See Web
M17/84-RG223-0XDS2 Coax, 50 Ohm						
Part No.	PE3M0039	Cable Dia.	Attn. @ 1 GHz	Power @ 1 GHz		
1 piece price shown. See web or call for volume pricing.						
12"	18"	24"	30"	36"	48"	Custom Len.
\$175.44	\$180.31	\$185.19	\$190.06	\$194.95	\$204.70	See Web
M17/128-RG400-27478 Coax, 50 Ohm						
Part No.	PE3M0067	Cable Dia.	Attn. @ 1 GHz	Power @ 1 GHz		
1 piece price shown. See web or call for volume pricing.						
12"	18"	24"	30"	36"	48"	Custom Len.
\$172.62	\$176.09	\$179.56	\$183.03	\$186.50	\$193.44	See Web
N FEMALE TO N FEMALE BULKHEAD						
SEE MOUNTING HOLE SECTION ON PAGE 369						
Standard Flexible Cable Assemblies						
M17/60-RG142-27478 Coax, 50 Ohm						
Part No.	PE3M0012	Cable Dia.	Attn. @ 1 GHz	Power @ 1 GHz		
1 piece price shown. See web or call for volume pricing.						
12"	18"	24"	30"	36"	48"	Custom Len.
\$174.98	\$177.70	\$180.43	\$183.15	\$185.89	\$191.34	See Web
M17/84-RG223-0XDS2 Coax, 50 Ohm						
Part No.	PE3M0040	Cable Dia.	Attn. @ 1 GHz	Power @ 1 GHz		
1 piece price shown. See web or call for volume pricing.						
12"	18"	24"	30"	36"	48"	Custom Len.
\$179.28	\$184.15	\$189.04	\$193.91	\$198.79	\$208.55	See Web
M17/128-RG400-27478 Coax, 50 Ohm						
Part No.	PE3M0068	Cable Dia.	Attn. @ 1 GHz	Power @ 1 GHz		
1 piece price shown. See web or call for volume pricing.						
12"	18"	24"	30"	36"	48"	Custom Len.
\$176.46	\$179.93	\$183.40	\$186.87	\$190.34	\$197.29	See Web
N FEMALE TO SMA MALE						
Standard Flexible Cable Assemblies						
M17/60-RG142-27478 Coax, 50 Ohm						
Part No.	PE3M0017	Cable Dia.	Attn. @ 1 GHz	Power @ 1 GHz		
1 piece price shown. See web or call for volume pricing.						
12"	18"	24"	30"	36"	48"	Custom Len.
\$194.87	\$197.60	\$200.33	\$203.05	\$205.78	\$211.24	See Web
M17/84-RG223-0XDS2 Coax, 50 Ohm						
Part No.	PE3M0045	Cable Dia.	Attn. @ 1 GHz	Power @ 1 GHz		
1 piece price shown. See web or call for volume pricing.						
12"	18"	24"	30"	36"	48"	Custom Len.
\$199.18	\$204.05	\$208.93	\$213.81	\$218.69	\$228.44	See Web
M17/128-RG400-27478 Coax, 50 Ohm						
Part No.	PE3M0073	Cable Dia.	Attn. @ 1 GHz	Power @ 1 GHz		
1 piece price shown. See web or call for volume pricing.						
12"	18"	24"	30"	36"	48"	Custom Len.
\$196.36	\$199.83	\$203.30	\$206.77	\$210.24	\$217.18	See Web
N FEMALE TO SMA MALE RIGHT ANGLE						
Standard Flexible Cable Assemblies						
M17/60-RG142-27478 Coax, 50 Ohm						
Part No.	PE3M0018	Cable Dia.	Attn. @ 1 GHz	Power @ 1 GHz		
1 piece price shown. See web or call for volume pricing.						
12"	18"	24"	30"	36"	48"	Custom Len.
\$230.96	\$233.68	\$236.41	\$239.14	\$241.87	\$247.32	See Web
M17/84-RG223-0XDS2 Coax, 50 Ohm						
Part No.	PE3M0046	Cable Dia.	Attn. @ 1 GHz	Power @ 1 GHz		
1 piece price shown. See web or call for volume pricing.						
12"	18"	24"	30"	36"	48"	Custom Len.
\$235.26	\$240.13	\$245.02	\$249.89	\$254.77	\$264.53	See Web
M17/128-RG400-27478 Coax, 50 Ohm						
Part No.	PE3M0074	Cable Dia.	Attn. @ 1 GHz	Power @ 1 GHz		
1 piece price shown. See web or call for volume pricing.						
12"	18"	24"	30"	36"	48"	Custom Len.
\$232.45	\$235.90	\$239.39	\$242.85	\$246.33	\$253.27	See Web
N FEMALE TO TNC MALE						
Standard Flexible Cable Assemblies						
M17/60-RG142-27478 Coax, 50 Ohm						

\*Coax Performance at 1 GHz Notes: Cable assembly max frequency may be lower than connector or coax max frequency

For our complete selection of cable assemblies, please visit our website

Part No. <a href="#">PE3M0019</a>	Cable Dia.	Attn. @ 1 GHz	Power @ 1 GHz
1 piece price shown. See web or call for volume pricing.			
12"	18"	24"	30"
\$164.16	\$166.88	\$169.62	\$172.34
36"	48"	60"	72"
\$175.07	\$180.53		

**M17/84-RG223-0XDS2 Coax, 50 Ohm**

Part No. <a href="#">PE3M0047</a>	Cable Dia.	Attn. @ 1 GHz	Power @ 1 GHz
1 piece price shown. See web or call for volume pricing.			
12"	18"	24"	30"
\$168.46	\$173.34	\$178.22	\$183.09
36"	48"	60"	72"
\$187.98	\$197.73		

**M17/128-RG400-27478 Coax, 50 Ohm**

Part No. <a href="#">PE3M0075</a>	Cable Dia.	Attn. @ 1 GHz	Power @ 1 GHz
1 piece price shown. See web or call for volume pricing.			
12"	18"	24"	30"
\$165.65	\$169.12	\$172.59	\$176.06
36"	48"	60"	72"
\$179.53	\$186.47		

**N FEMALE TO 7/16 DIN MALE**



**Low PIM Corrugated Cable Assemblies**

**SPP-250-LLPL Coax, 50 Ohm**

Part No. <a href="#">PE3C4133</a>	Cable Dia.	Attn. @ 1 GHz	Power @ 1 GHz
1 piece price shown. See web or call for volume pricing.			
12"	24"	36"	48"
\$92.38	\$97.96	\$103.54	\$109.12
60"	72"	84"	96"
\$114.70	\$119.55		

**N FEMALE TO N FEMALE**



**Low Loss Flexible Cable Assemblies**

**LMR-600-DB Coax, 50 Ohm**

Part No. <a href="#">PE3W05453</a>	Cable Dia.	Attn. @ 1 GHz	Power @ 1 GHz
1 piece price shown. See web or call for volume pricing.			
12"	18"	24"	36"
\$70.64	\$71.93	\$73.23	\$75.82
48"	60"	72"	84"
\$78.41	\$81.00		

**Low Loss Test Flexible Cable Assemblies**

**PE-P300LL Coax, 50 Ohm**

Part No. <a href="#">PE3C3234</a>	Cable Dia.	Attn. @ 1 GHz	Power @ 1 GHz
1 piece price shown. See web or call for volume pricing.			
12"	24"	36"	48"
\$269.26	\$294.44	\$319.62	\$344.80
60"	72"	84"	96"
\$369.99	\$385.40		

**Standard Corrugated Cable Assemblies**

**PE-1/4SFHC Coax, 50 Ohm**

Part No. <a href="#">PE3C0126</a>	Cable Dia.	Attn. @ 1 GHz	Power @ 1 GHz
1 piece price shown. See web or call for volume pricing.			
12"	24"	36"	48"
\$141.41	\$131.34	\$147.64	\$136.92
60"	72"	84"	96"
\$139.70			

**N FEMALE TO N FEMALE BULKHEAD**

SEE MOUNTING HOLE SECTION ON PAGE 369



**Standard Flexible Cable Assemblies**

**PE-P195 Coax, 50 Ohm**

Part No. <a href="#">PE3W02976</a>	Cable Dia.	Attn. @ 1 GHz	Power @ 1 GHz
1 piece price shown. See web or call for volume pricing.			
12"	24"	36"	48"
\$53.08	\$63.49	\$73.91	\$84.34
60"	72"	84"	96"
\$94.76	\$59.75		

**N FEMALE TO QN MALE RIGHT ANGLE**



**Low Loss Flexible Cable Assemblies**

**PE-C195 Coax, 50 Ohm**

Part No. <a href="#">PE38494</a>	Cable Dia.	Attn. @ 1 GHz	Power @ 1 GHz
1 piece price shown. See web or call for volume pricing.			
12"	24"	36"	48"
\$65.21	\$65.85	\$66.58	\$67.23
60"	72"	84"	96"
\$67.96	\$75.71		

**Standard Flexible Cable Assemblies**

**RG58C/U Coax, 50 Ohm**

Part No. <a href="#">PE38493</a>	Cable Dia.	Attn. @ 1 GHz	Power @ 1 GHz
1 piece price shown. See web or call for volume pricing.			
12"	24"	36"	48"
\$77.26	\$77.99	\$78.70	\$79.43
60"	72"	84"	96"
\$80.21	\$80.92		

**RG213/U Coax, 50 Ohm**

Part No. <a href="#">PE38495</a>	Cable Dia.	Attn. @ 1 GHz	Power @ 1 GHz
1 piece price shown. See web or call for volume pricing.			
12"	24"	36"	48"
\$90.15	\$91.85	\$93.52	\$95.21
60"	72"	84"	96"
\$96.88	\$98.52		

**N FEMALE TO SMA MALE RIGHT ANGLE**



Low Loss Flexible Cable Assemblies						
LMR-240-UF Coax, 50 Ohm						
Part No. <a href="#">PE3W04423</a>	Cable Dia.	Attn. @ 1 GHz	Power @ 1 GHz			
1 piece price shown. See web or call for volume pricing.						
12"	24"	36"	48"	60"	72"	84"
\$52.56	\$53.90	\$55.25	\$56.60	\$57.96	\$59.31	\$60.66

**N FEMALE TO TNC MALE**



**Low Loss Test Flexible Cable Assemblies**

**PE-P300LL Coax, 50 Ohm**

Part No. <a href="#">PE3C3244</a>	Cable Dia.	Attn. @ 1 GHz	Power @ 1 GHz
1 piece price shown. See web or call for volume pricing.			
12"	24"	36"	48"
\$244.93	\$270.13	\$295.34	\$320.54
60"	72"	84"	96"
\$345.75	\$361.07		

**N FEMALE BULKHEAD TO N FEMALE BULKHEAD**

SEE MOUNTING HOLE SECTION ON PAGE 369



**Standard Flexible Cable Assemblies**

**M17/60-RG142-27478 Coax, 50 Ohm**

Part No. <a href="#">PE3M0013</a>	Cable Dia.	Attn. @ 1 GHz	Power @ 1 GHz
1 piece price shown. See web or call for volume pricing.			
12"	18"	24"	30"
\$178.82	\$181.54	\$184.28	\$187.00
36"	48"	60"	72"
\$189.73	\$195.19		

**M17/84-RG223-0XDS2 Coax, 50 Ohm**

Part No. <a href="#">PE3M0041</a>	Cable Dia.	Attn. @ 1 GHz	Power @ 1 GHz
1 piece price shown. See web or call for volume pricing.			
12"	18"	24"	30"
\$183.12	\$188.00	\$192.88	\$197.75
36"	48"	60"	72"
\$202.64	\$212.39		

**M17/128-RG400-27478 Coax, 50 Ohm**

Part No. <a href="#">PE3M0069</a>	Cable Dia.	Attn. @ 1 GHz	Power @ 1 GHz
1 piece price shown. See web or call for volume pricing.			
12"	18"	24"	30"
\$180.31	\$183.78	\$187.25	\$190.72
36"	48"	60"	72"
\$194.19	\$201.13		

**N FEMALE BULKHEAD TO SMA MALE**

SEE MOUNTING HOLE SECTION ON PAGE 369



**Standard Flexible Cable Assemblies**

**M17/60-RG142-27478 Coax, 50 Ohm**

Part No. <a href="#">PE3M0020</a>	Cable Dia.	Attn. @ 1 GHz	Power @ 1 GHz
1 piece price shown. See web or call for volume pricing.			
12"	18"	24"	30"
\$198.72	\$201.44	\$204.17	\$206.90
36"	48"	60"	72"
\$209.63	\$215.08		

**M17/84-RG223-0XDS2 Coax, 50 Ohm**

Part No. <a href="#">PE3M0048</a>	Cable Dia.	Attn. @ 1 GHz	Power @ 1 GHz
1 piece price shown. See web or call for volume pricing.			
12"	18"	24"	30"
\$203.02	\$207.89	\$212.78	\$217.65
36"	48"	60"	72"
\$222.53	\$232.29		

**M17/128-RG400-27478 Coax, 50 Ohm**

Part No. <a href="#">PE3M0076</a>	Cable Dia.	Attn. @ 1 GHz	Power @ 1 GHz
1 piece price shown. See web or call for volume pricing.			
12"	18"	24"	30"
\$200.20	\$203.68	\$207.15	\$210.62
36"	48"	60"	72"
\$214.09	\$221.03		

**N FEMALE BULKHEAD TO SMA MALE RIGHT ANGLE**

SEE MOUNTING HOLE SECTION ON PAGE 369



**Standard Flexible Cable Assemblies**

**M17/60-RG142-27478 Coax, 50 Ohm**

Part No. <a href="#">PE3M0021</a>	Cable Dia.	Attn. @ 1 GHz	Power @ 1 GHz
1 piece price shown. See web or call for volume pricing.			
12"	18"	24"	30"
\$234.80	\$237.53	\$240.26	\$242.98
36"	48"	60"	72"
\$245.71	\$251.17		

**M17/84-RG223-0XDS2 Coax, 50 Ohm**

Part No. <a href="#">PE3M0049</a>	Cable Dia.	Attn. @ 1 GHz	Power @ 1 GHz
1 piece price shown. See web or call for volume pricing.			
12"	18"	24"	30"
\$239.11	\$243.98	\$248.86	\$253.73
36"	48"	60"	72"
\$258.62	\$268.37		

**M17/128-RG400-27478 Coax, 50 Ohm**

Part No. <a href="#">PE3M0077</a>	Cable Dia.	Attn. @ 1 GHz	Power @ 1 GHz
1 piece price shown. See web or call for volume pricing.			
12"	18"	24"	30"
\$236.29	\$239.75	\$243.23	\$246.69
36"	48"	60"	72"
\$250.17	\$257.11		

**N FEMALE BULKHEAD TO TNC MALE**

SEE MOUNTING HOLE SECTION ON PAGE 369



**Standard Flexible Cable Assemblies**

Cable Assemblies

See Our Website For Current Pricing & Real-Time Stock Availability!

Continued on Next Page

For Custom Lengths, Metric Lengths or Special Configurations, Please call (949) 261-1920

Technical Support  
+1 (949) 261-1920

Same-Day Shipping,  
Even Custom Cable Assemblies

For our complete selection of cable assemblies, please visit our website

Cable Assemblies

See Our Website For Current Pricing & Real-Time Stock Availability!

M17/60-RG142-27478 Coax, 50 Ohm				
Part No. <b>PE3M0022</b>	Cable Dia.	Attn. @ 1 GHz	Power @ 1 GHz	79
1 piece price shown. See web or call for volume pricing.				
12"	18"	24"	30"	
\$168.01	\$170.73	\$173.46	\$176.18	
M17/84-RG223-0XDS2 Coax, 50 Ohm				
Part No. <b>PE3M0050</b>	Cable Dia.	Attn. @ 1 GHz	Power @ 1 GHz	80
1 piece price shown. See web or call for volume pricing.				
12"	18"	24"	30"	
\$172.31	\$177.18	\$182.06	\$186.94	
M17/128-RG400-27478 Coax, 50 Ohm				
Part No. <b>PE3M0078</b>	Cable Dia.	Attn. @ 1 GHz	Power @ 1 GHz	81
1 piece price shown. See web or call for volume pricing.				
12"	18"	24"	30"	
\$169.49	\$172.96	\$176.43	\$179.90	
N FEMALE BULKHEAD TO BNC MALE				
SEE MOUNTING HOLE SECTION ON PAGE 369				
Low Loss Flexible Cable Assemblies				
LMR-200 Coax, 50 Ohm				
Part No. <b>PE3W07094</b>	Cable Dia.	Attn. @ 1 GHz	Power @ 1 GHz	82
1 piece price shown. See web or call for volume pricing.				
12"	18"	24"	36"	
\$45.85	\$46.19	\$46.54	\$47.23	
N FEMALE BULKHEAD TO MCX PLUG RIGHT ANGLE				
SEE MOUNTING HOLE SECTION ON PAGE 369				
Precision Formable Cable Assemblies				
PE-SR405FL Coax, 50 Ohm				
Part No. <b>PE39449</b>	Cable Dia.	Attn. @ 1 GHz	Power @ 1 GHz	83
1 piece price shown. See web or call for volume pricing.				
6"	9"	12"	18"	
\$51.08	\$52.40	\$52.40	\$62.26	
PE-SR405FLJ Coax, 50 Ohm				
Part No. <b>PE39463</b>	Cable Dia.	Attn. @ 1 GHz	Power @ 1 GHz	84
1 piece price shown. See web or call for volume pricing.				
6"	9"	12"	18"	
\$49.26	\$49.26	\$49.26	\$53.13	
N FEMALE BULKHEAD TO MMCX PLUG RIGHT ANGLE				
SEE MOUNTING HOLE SECTION ON PAGE 369				
Precision Formable Cable Assemblies				
PE-SR405FL Coax, 50 Ohm				
Part No. <b>PE39450</b>	Cable Dia.	Attn. @ 1 GHz	Power @ 1 GHz	85
1 piece price shown. See web or call for volume pricing.				
6"	9"	12"	18"	
\$51.94	\$51.94	\$56.10	\$57.29	
PE-SR405FLJ Coax, 50 Ohm				
Part No. <b>PE39464</b>	Cable Dia.	Attn. @ 1 GHz	Power @ 1 GHz	86
1 piece price shown. See web or call for volume pricing.				
6"	9"	12"	18"	
\$49.65	\$51.72	\$49.81	\$53.69	
N FEMALE BULKHEAD TO N MALE				
SEE MOUNTING HOLE SECTION ON PAGE 369				
Standard Flexible Cable Assemblies				
PE-P141EAM Coax, 50 Ohm				
Part No. <b>PE3CA1050</b>	Cable Dia.	Attn. @ 1 GHz	Power @ 1 GHz	87
1 piece price shown. See web or call for volume pricing.				
12"	24"	36"	50CM	
\$92.34	\$109.82	\$127.30	\$103.54	
N FEMALE BULKHEAD TO N MALE RIGHT ANGLE				
SEE MOUNTING HOLE SECTION ON PAGE 369				
Low Loss Flexible Cable Assemblies				
PE-P142LL-27478 Coax, 50 Ohm				
Part No. <b>PE3M0178</b>	Cable Dia.	Attn. @ 1 GHz	Power @ 1 GHz	88
1 piece price shown. See web or call for volume pricing.				
12"	18"	24"	36"	
\$572.29	\$580.77	\$589.25	\$606.20	
PE-P160LL-27478 Coax, 50 Ohm				
Part No. <b>PE3M0223</b>	Cable Dia.	Attn. @ 1 GHz	Power @ 1 GHz	89
1 piece price shown. See web or call for volume pricing.				
8"	12"	18"	24"	
\$540.67	\$545.58	\$552.92	\$560.28	
PE-P300LL-27478 Coax, 50 Ohm				

Part No. <b>PE3M0251</b>	Cable Dia.	Attn. @ 1 GHz	Power @ 1 GHz	90
1 piece price shown. See web or call for volume pricing.				
12"	18"	24"	36"	
\$638.67	\$652.82	\$666.98	\$695.28	
Standard Formable Cable Assemblies				
PE-SR402FLJ Coax, 50 Ohm				
Part No. <b>PE3W03365</b>	Cable Dia.	Attn. @ 1 GHz	Power @ 1 GHz	91
1 piece price shown. See web or call for volume pricing.				
12"	24"	36"	48"	
\$75.30	\$84.18	\$93.06	\$101.95	
N FEMALE BULKHEAD TO N FEMALE BULKHEAD				
SEE MOUNTING HOLE SECTION ON PAGE 369				
Low Loss Flexible Cable Assemblies				
PE-P142LL-27478 Coax, 50 Ohm				
Part No. <b>PE3M0177</b>	Cable Dia.	Attn. @ 1 GHz	Power @ 1 GHz	92
1 piece price shown. See web or call for volume pricing.				
12"	18"	24"	36"	
\$544.46	\$552.94	\$561.41	\$578.37	
PE-P160LL-27478 Coax, 50 Ohm				
Part No. <b>PE3M0222</b>	Cable Dia.	Attn. @ 1 GHz	Power @ 1 GHz	93
1 piece price shown. See web or call for volume pricing.				
8"	12"	18"	24"	
\$544.61	\$549.52	\$556.86	\$564.22	
PE-P300LL-27478 Coax, 50 Ohm				
Part No. <b>PE3M0250</b>	Cable Dia.	Attn. @ 1 GHz	Power @ 1 GHz	94
1 piece price shown. See web or call for volume pricing.				
12"	18"	24"	36"	
\$569.41	\$583.56	\$597.72	\$626.02	
PE-P160LL Coax, 50 Ohm				
Part No. <b>PE3C5256</b>	Cable Dia.	Attn. @ 1 GHz	Power @ 1 GHz	95
1 piece price shown. See web or call for volume pricing.				
12"	24"	36"	48"	
\$258.01	\$278.73	\$299.44	\$320.15	
N FEMALE BULKHEAD TO QMA MALE RIGHT ANGLE				
SEE MOUNTING HOLE SECTION ON PAGE 369				
Standard Flexible Cable Assemblies				
RG316/U Coax, 50 Ohm				
Part No. <b>PE3C4238</b>	Cable Dia.	Attn. @ 1 GHz	Power @ 1 GHz	96
1 piece price shown. See web or call for volume pricing.				
12"	24"	36"	48"	
\$65.08	\$68.12	\$71.15	\$74.18	
N FEMALE BULKHEAD TO SMA MALE				
SEE MOUNTING HOLE SECTION ON PAGE 369				
Low Loss Flexible Cable Assemblies				
PE-P160LL Coax, 50 Ohm				
Part No. <b>PE3C5274</b>	Cable Dia.	Attn. @ 1 GHz	Power @ 1 GHz	97
1 piece price shown. See web or call for volume pricing.				
12"	24"	36"	48"	
\$231.73	\$252.45	\$273.15	\$293.87	
N FEMALE BULKHEAD TO SMA MALE RIGHT ANGLE				
SEE MOUNTING HOLE SECTION ON PAGE 369				
Flexible Cable Assemblies				
PE-P195 Coax, 50 Ohm				
Part No. <b>PE3W06405</b>	Cable Dia.	Attn. @ 1 GHz	Power @ 1 GHz	98
1 piece price shown. See web or call for volume pricing.				
12"	24"	36"	48"	
\$51.27	\$61.69	\$72.11	\$82.53	
Low Loss Flexible Cable Assemblies				
PE-P160LL Coax, 50 Ohm				
Part No. <b>PE3C5276</b>	Cable Dia.	Attn. @ 1 GHz	Power @ 1 GHz	99
1 piece price shown. See web or call for volume pricing.				
12"	24"	36"	48"	
\$268.84	\$289.56	\$310.27	\$330.97	
N FEMALE BULKHEAD TO SMA FEMALE				
SEE MOUNTING HOLE SECTION ON PAGE 369				
Flexible Cable Assemblies				
LMR-400-UF Coax, 50 Ohm				
Part No. <b>PE3W05630</b>	Cable Dia.	Attn. @ 1 GHz	Power @ 1 GHz	1
1 piece price shown. See web or call for volume pricing.				
12"	24"	36"	48"	
\$85.21	\$87.83	\$90.46	\$93.08	

\*Coax Performance at 1 GHz Notes: Cable assembly max frequency may be lower than connector or coax max frequency

For our complete selection of cable assemblies, please visit our website

<b>N FEMALE BULKHEAD TO SMA FEMALE BULKHEAD</b>							
SEE MOUNTING HOLE SECTION ON PAGE 369							
Standard Flexible Cable Assemblies							
PE-P160LL Coax, 50 Ohm							
Part No. <a href="#">PE3C5278</a>	Cable Dia.			Attn. @ 1 GHz	Power @ 1 GHz		
1 piece price shown. See web or call for volume pricing.							
12"	24"	36"	48"	0.160" dia.	dB/100ft	W	
\$248.74	\$248.74	\$248.74	\$248.74	60"	50CM	Custom Len.	
See Web							
<b>N FEMALE BULKHEAD TO REVERSE POLARITY SMA MALE RIGHT ANGLE</b>							
SEE MOUNTING HOLE SECTION ON PAGE 369							
Standard Flexible Cable Assemblies							
RG400/U Coax, 50 Ohm							
Part No. <a href="#">PE3C5030</a>	Cable Dia.			Attn. @ 1 GHz	Power @ 1 GHz		
1 piece price shown. See web or call for volume pricing.							
12"	24"	36"	48"	0.195" dia.	15 dB/100ft	600 W	
\$78.89	\$86.07	\$93.25	\$100.43	60"	50CM	Custom Len.	
See Web							
<b>N FEMALE BULKHEAD TO SMP FEMALE RIGHT ANGLE</b>							
SEE MOUNTING HOLE SECTION ON PAGE 369							
Standard Flexible Cable Assemblies							
RG178B/U Coax, 50 Ohm							
Part No. <a href="#">PE3W04763</a>	Cable Dia.			Attn. @ 1 GHz	Power @ 1 GHz		
1 piece price shown. See web or call for volume pricing.							
12"	24"	36"	48"	0.072" dia.	44 dB/100ft	55 W	
\$73.41	\$74.43	\$75.46	\$76.49	60"	50CM	Custom Len.	
See Web							
<b>N FEMALE BULKHEAD TO TNC MALE</b>							
SEE MOUNTING HOLE SECTION ON PAGE 369							
Low Loss Flexible Cable Assemblies							
PE-P142LL Coax, 50 Ohm							
Part No. <a href="#">PE3C1110</a>	Cable Dia.			Attn. @ 1 GHz	Power @ 1 GHz		
1 piece price shown. See web or call for volume pricing.							
12"	24"	36"	48"	0.195" dia.	10 dB/100ft	W	
\$187.67	\$203.44	\$220.30	\$234.95	60"	50CM	Custom Len.	
See Web							
PE-P160LL Coax, 50 Ohm							
Part No. <a href="#">PE3C5270</a>	Cable Dia.			Attn. @ 1 GHz	Power @ 1 GHz		
1 piece price shown. See web or call for volume pricing.							
12"	24"	36"	48"	0.160" dia.	dB/100ft	W	
\$231.73	\$252.45	\$273.15	\$293.87	60"	50CM	Custom Len.	
See Web							
Low Loss Test Flexible Cable Assemblies							
PE-P300LL Coax, 50 Ohm							
Part No. <a href="#">PE3C1084</a>	Cable Dia.			Attn. @ 1 GHz	Power @ 1 GHz		
1 piece price shown. See web or call for volume pricing.							
12"	24"	36"	48"	0.300" dia.	6 dB/100ft	W	
\$253.67	\$278.85	\$304.03	\$329.22	60"	50CM	Custom Len.	
See Web							
<b>N FEMALE BULKHEAD TO TNC MALE RIGHT ANGLE</b>							
SEE MOUNTING HOLE SECTION ON PAGE 369							
Low Loss Flexible Cable Assemblies							
LMR-240 Coax, 50 Ohm							
Part No. <a href="#">PE3W00415</a>	Cable Dia.			Attn. @ 1 GHz	Power @ 1 GHz		
1 piece price shown. See web or call for volume pricing.							
12"	24"	36"	48"	0.240" dia.	8 dB/100ft	W	
\$53.67	\$54.61	\$55.56	\$56.50	60"	50CM	Custom Len.	
See Web							
PE-P160LL Coax, 50 Ohm							
Part No. <a href="#">PE3C5271</a>	Cable Dia.			Attn. @ 1 GHz	Power @ 1 GHz		
1 piece price shown. See web or call for volume pricing.							
12"	24"	36"	48"	0.160" dia.	dB/100ft	W	
\$290.49	\$311.21	\$331.92	\$352.63	60"	50CM	Custom Len.	
See Web							
<b>N FEMALE BULKHEAD TO TNC FEMALE BULKHEAD</b>							
SEE MOUNTING HOLE SECTION ON PAGE 369							
Low Loss Flexible Cable Assemblies							
PE-P160LL Coax, 50 Ohm							
Part No. <a href="#">PE3C5272</a>	Cable Dia.			Attn. @ 1 GHz	Power @ 1 GHz		
1 piece price shown. See web or call for volume pricing.							
12"	24"	36"	48"	0.160" dia.	dB/100ft	W	
\$258.01	\$278.73	\$299.44	\$320.15	60"	50CM	Custom Len.	
See Web							
<b>N FEMALE BULKHEAD TO HMCX32 1.2 PLUG</b>							
SEE MOUNTING HOLE SECTION ON PAGE 369							

Standard Flexible Cable Assemblies							
PE-81mm Coax, 50 Ohm							
Part No. <a href="#">PE3CA1015</a>	Cable Dia.			Attn. @ 1 GHz	Power @ 1 GHz		
1 piece price shown. See web or call for volume pricing.							
3"	6"	12"	-	0.032" dia.	dB/100ft	W	
\$17.70	\$20.40	\$17.70	-	-	-	Custom Len.	
See Web							
<b>N FEMALE BULKHEAD TO UMCX 2.1 PLUG</b>							
SEE MOUNTING HOLE SECTION ON PAGE 369							
Standard Flexible Cable Assemblies							
PE-81mm Coax, 50 Ohm							
Part No. <a href="#">PE3CA1013</a>	Cable Dia.			Attn. @ 1 GHz	Power @ 1 GHz		
1 piece price shown. See web or call for volume pricing.							
3"	6"	12"	-	0.032" dia.	dB/100ft	W	
\$17.70	\$20.40	\$20.40	-	-	-	Custom Len.	
See Web							
<b>N FEMALE BULKHEAD TO UMCX 2.5 PLUG</b>							
SEE MOUNTING HOLE SECTION ON PAGE 369							
Standard Flexible Cable Assemblies							
RG178B/U Coax, 50 Ohm							
Part No. <a href="#">PE3CA1011</a>	Cable Dia.			Attn. @ 1 GHz	Power @ 1 GHz		
1 piece price shown. See web or call for volume pricing.							
6"	9"	12"	-	0.070" dia.	dB/100ft	W	
\$18.97	\$17.70	\$17.70	-	-	-	Custom Len.	
See Web							
RG178-DS Coax, 50 Ohm							
Part No. <a href="#">PE3CA1012</a>	Cable Dia.			Attn. @ 1 GHz	Power @ 1 GHz		
1 piece price shown. See web or call for volume pricing.							
6"	9"	12"	-	0.086" dia.	dB/100ft	W	
\$17.70	\$21.53	\$17.70	-	-	-	Custom Len.	
See Web							
PE-81mm Coax, 50 Ohm							
Part No. <a href="#">PE3CA1008</a>	Cable Dia.			Attn. @ 1 GHz	Power @ 1 GHz		
1 piece price shown. See web or call for volume pricing.							
3"	6"	12"	-	0.032" dia.	dB/100ft	W	
\$17.70	\$17.70	\$17.70	-	-	-	Custom Len.	
See Web							
PE-113mm Coax, 50 Ohm							
Part No. <a href="#">PE3CA1009</a>	Cable Dia.			Attn. @ 1 GHz	Power @ 1 GHz		
1 piece price shown. See web or call for volume pricing.							
3"	6"	12"	-	0.044" dia.	dB/100ft	W	
\$17.70	\$17.70	\$20.40	-	-	-	Custom Len.	
See Web							
PE-137mm Coax, 50 Ohm							
Part No. <a href="#">PE3CA1010</a>	Cable Dia.			Attn. @ 1 GHz	Power @ 1 GHz		
1 piece price shown. See web or call for volume pricing.							
3"	6"	12"	-	0.053" dia.	dB/100ft	W	
\$17.70	\$17.70	\$17.70	-	-	-	Custom Len.	
See Web							
<b>N FEMALE 4 HOLE FLANGE TO MMCX PLUG RIGHT ANGLE</b>							
SEE MOUNTING HOLE SECTION ON PAGE 369							
Low Loss Flexible Cable Assemblies							
LMR-100A-PVC Coax, 50 Ohm							
Part No. <a href="#">PE3C0063</a>	Cable Dia.			Attn. @ 1 GHz	Power @ 1 GHz		
1 piece price shown. See web or call for volume pricing.							
12"	24"	36"	48"	0.110" dia.	24 dB/100ft	W	
\$56.23	\$52.75	\$53.46	\$54.15	60"	50CM	Custom Len.	
See Web							
<b>NMO MOUNT SEXLESS TO TNC MALE</b>							
Standard Flexible Cable Assemblies							
RG58C/U Coax, 50 Ohm							
Part No. <a href="#">PE37848</a>	Cable Dia.			Attn. @ 1 GHz	Power @ 1 GHz		
1 piece price shown. See web or call for volume pricing.							
60"	120"	180"	-	0.195" dia.	20 dB/100ft	44 W	
\$46.68	\$46.79	\$50.46	-	-	-	Custom Len.	
See Web							
<b>QMA MALE TO QMA MALE</b>							
Low Loss Flexible Cable Assemblies							
PE-C195 Coax, 50 Ohm							
Part No. <a href="#">PE38272</a>	Cable Dia.			Attn. @ 1 GHz	Power @ 1 GHz		
1 piece price shown. See web or call for volume pricing.							
12"	24"	36"	48"	0.195" dia.	11 dB/100ft	150 W	
\$49.60	\$50.32	\$54.14	\$51.74	60"	72"	Custom Len.	
See Web							
Low PIM Corrugated Cable Assemblies							
SPP-250-LLPL Coax, 50 Ohm							

Cable Assemblies

See Our Website For Current Pricing & Real-Time Stock Availability!

Continued on Next Page

For Custom Lengths, Metric Lengths or Special Configurations, Please call (949) 261-1920

Technical Support  
+1 (949) 261-1920

Same-Day Shipping,  
Even Custom Cable Assemblies

For our complete selection of cable assemblies, please visit our website

Part No.	Cable Dia.				Attn. @ 1 GHz	Power @ 1 GHz
<a href="#">PE3C5869</a>	0.280" dia.				dB/100ft	W
1 piece price shown. See web or call for volume pricing.	12"	24"	36"	48"	60"	50CM Custom Len.
	\$71.79	\$77.37	\$82.95	\$88.53	\$94.11	\$75.37 See Web
Standard Flexible Cable Assemblies						
RG58C/U Coax, 50 Ohm						
<a href="#">PE38271</a>	0.195" dia.				20 dB/100ft	44 W
1 piece price shown. See web or call for volume pricing.	12"	24"	36"	48"	60"	72" Custom Len.
	\$57.47	\$58.20	\$58.94	\$59.68	\$60.42	\$61.16 See Web
RG316/U Coax, 50 Ohm						
<a href="#">PE38270</a>	0.098" dia.				38 dB/100ft	160 W
1 piece price shown. See web or call for volume pricing.	12"	24"	36"	48"	60"	72" Custom Len.
	\$61.20	\$64.09	\$71.12	\$69.85	\$77.61	\$75.64 See Web
RG316-DS Coax, 50 Ohm						
<a href="#">PE38161</a>	0.114" dia.				26 dB/100ft	160 W
1 piece price shown. See web or call for volume pricing.	12"	24"	36"	48"	60"	72" Custom Len.
	\$96.47	\$99.40	\$102.29	\$105.23	\$108.18	\$111.11 See Web
QMA MALE TO QMA MALE RIGHT ANGLE						
Low PIM Corrugated Cable Assemblies						
SPP-250-LLPL Coax, 50 Ohm						
<a href="#">PE3C5875</a>	0.280" dia.				dB/100ft	W
1 piece price shown. See web or call for volume pricing.	12"	24"	36"	48"	60"	50CM Custom Len.
	\$73.97	\$79.55	\$85.13	\$90.70	\$96.28	\$77.54 See Web
QMA MALE TO QMA FEMALE						
Low PIM Corrugated Cable Assemblies						
SPP-250-LLPL Coax, 50 Ohm						
<a href="#">PE3C5863</a>	0.280" dia.				dB/100ft	W
1 piece price shown. See web or call for volume pricing.	12"	24"	36"	48"	60"	50CM Custom Len.
	\$68.20	\$73.78	\$79.36	\$84.94	\$90.52	\$71.77 See Web
QMA MALE TO SMA MALE						
Low PIM Corrugated Cable Assemblies						
SPP-250-LLPL Coax, 50 Ohm						
<a href="#">PE3C5870</a>	0.280" dia.				dB/100ft	W
1 piece price shown. See web or call for volume pricing.	12"	24"	36"	48"	60"	50CM Custom Len.
	\$64.57	\$70.15	\$75.73	\$81.31	\$86.89	\$68.15 See Web
QMA MALE TO SMA MALE RIGHT ANGLE						
Low PIM Corrugated Cable Assemblies						
SPP-250-LLPL Coax, 50 Ohm						
<a href="#">PE3C5893</a>	0.280" dia.				dB/100ft	W
1 piece price shown. See web or call for volume pricing.	12"	24"	36"	48"	60"	50CM Custom Len.
	\$66.03	\$71.61	\$77.19	\$82.77	\$88.35	\$69.60 See Web
QMA MALE TO SMA FEMALE						
Low PIM Corrugated Cable Assemblies						
SPP-250-LLPL Coax, 50 Ohm						
<a href="#">PE3C5882</a>	0.280" dia.				dB/100ft	W
1 piece price shown. See web or call for volume pricing.	12"	24"	36"	48"	60"	50CM Custom Len.
	\$65.30	\$70.88	\$76.46	\$82.04	\$87.62	\$68.88 See Web
QMA MALE RIGHT ANGLE TO QMA MALE RIGHT ANGLE						
Low PIM Corrugated Cable Assemblies						
SPP-250-LLPL Coax, 50 Ohm						
<a href="#">PE3C5877</a>	0.280" dia.				dB/100ft	W
1 piece price shown. See web or call for volume pricing.	12"	24"	36"	48"	60"	50CM Custom Len.
	\$76.14	\$81.72	\$87.30	\$92.88	\$98.46	\$79.71 See Web

QMA MALE RIGHT ANGLE TO SMA MALE						
Flexible Cable Assemblies						
LMR-195 Coax, 50 Ohm						
<a href="#">PE3W06662</a>	0.195" dia.				12 dB/100ft	W
1 piece price shown. See web or call for volume pricing.	12"	24"	36"	48"	60"	50CM Custom Len.
	\$56.16	\$56.80	\$57.45	\$58.09	\$58.73	\$56.56 See Web
Low PIM Corrugated Cable Assemblies						
SPP-250-LLPL Coax, 50 Ohm						
<a href="#">PE3C5876</a>	0.280" dia.				dB/100ft	W
1 piece price shown. See web or call for volume pricing.	12"	24"	36"	48"	60"	50CM Custom Len.
	\$66.75	\$72.32	\$77.90	\$83.45	\$89.06	\$70.32 See Web
QMA FEMALE TO SMA MALE						
Low PIM Corrugated Cable Assemblies						
SPP-250-LLPL Coax, 50 Ohm						
<a href="#">PE3C5864</a>	0.280" dia.				dB/100ft	W
1 piece price shown. See web or call for volume pricing.	12"	24"	36"	48"	60"	50CM Custom Len.
	\$60.98	\$66.56	\$72.14	\$77.72	\$83.30	\$64.55 See Web
QN MALE TO QN MALE						
Low Loss Flexible Cable Assemblies						
PE-C195 Coax, 50 Ohm						
<a href="#">PE38449</a>	0.195" dia.				11 dB/100ft	150 W
1 piece price shown. See web or call for volume pricing.	12"	24"	36"	48"	60"	72" Custom Len.
	\$78.70	\$79.37	\$80.02	\$80.74	\$81.41	\$82.12 See Web
QN MALE TO QN MALE RIGHT ANGLE						
Low Loss Flexible Cable Assemblies						
PE-C195 Coax, 50 Ohm						
<a href="#">PE38486</a>	0.195" dia.				11 dB/100ft	150 W
1 piece price shown. See web or call for volume pricing.	12"	24"	36"	48"	60"	72" Custom Len.
	\$80.68	\$81.35	\$82.07	\$82.73	\$83.45	\$84.11 See Web
Standard Flexible Cable Assemblies						
RG58C/U Coax, 50 Ohm						
<a href="#">PE38485</a>	0.195" dia.				20 dB/100ft	44 W
1 piece price shown. See web or call for volume pricing.	12"	24"	36"	48"	60"	72" Custom Len.
	\$98.31	\$99.05	\$99.79	\$100.51	\$101.25	\$101.99 See Web
QN MALE RIGHT ANGLE TO N FEMALE						
Flexible Cable Assemblies						
LMR-400 Coax, 50 Ohm						
<a href="#">PE3W04619</a>	0.405" dia.				4 dB/100ft	W
1 piece price shown. See web or call for volume pricing.	12"	24"	36"	48"	60"	50CM Custom Len.
	\$87.59	\$88.83	\$90.08	\$91.33	\$92.57	\$88.39 See Web
SC MALE TO SC MALE						
Standard Flexible Cable Assemblies						
RG8A/U Coax, 50 Ohm						
<a href="#">PE34443</a>	0.405" dia.				8 dB/100ft	190 W
1 piece price shown. See web or call for volume pricing.	12"	24"	36"	48"	60"	72" Custom Len.
	\$153.34	\$165.61	\$159.00	\$171.93	\$164.67	\$167.50 See Web
RG214/U Coax, 50 Ohm						
<a href="#">PE3409</a>	0.425" dia.				7 dB/100ft	190 W
1 piece price shown. See web or call for volume pricing.	12"	24"	36"	48"	60"	72" Custom Len.
	\$158.25	\$165.59	\$172.90	\$180.24	\$187.56	\$194.87 See Web
RG223/U Coax, 50 Ohm						

Cable Assemblies

See Our Website For Current Pricing & Real-Time Stock Availability!

\*Coax Performance at 1 GHz Notes: Cable assembly max frequency may be lower than connector or coax max frequency



# For our complete selection of cable assemblies, please visit our website

Part No.	Cable Dia.				Attn. @ 1 GHz	Power @ 1 GHz
<b>PE3348</b>	1 piece price shown. See web or call for volume pricing.				0.210" dia.	13 dB/100ft 53 W
12"	24"	36"	48"	60"	72"	Custom Len.
\$234.80	\$237.69	\$240.63	\$243.57	\$246.45	\$249.39	See Web
<b>RG225/U Coax, 50 Ohm</b>						
<b>PE34447</b>	1 piece price shown. See web or call for volume pricing.				0.430" dia.	dB/100ft 1700 W
12"	24"	36"	48"	60"	72"	Custom Len.
\$196.05	\$218.55	\$252.15	\$285.76	\$319.35	\$352.95	See Web
<b>RG393/U Coax, 50 Ohm</b>						
<b>PE3416</b>	1 piece price shown. See web or call for volume pricing.				0.390" dia.	9 dB/100ft 1700 W
12"	24"	36"	48"	60"	72"	Custom Len.
\$166.96	\$193.38	\$209.78	\$213.36	\$228.83	\$244.29	See Web
<b>RG400/U Coax, 50 Ohm</b>						
<b>PE34453</b>	1 piece price shown. See web or call for volume pricing.				0.195" dia.	15 dB/100ft 650 W
12"	24"	36"	48"	60"	72"	Custom Len.
\$244.87	\$251.92	\$258.93	\$265.95	\$272.97	\$280.00	See Web
<b>SHV PLUG TO SHV PLUG</b>						
<b>Standard Flexible Cable Assemblies</b>						
<b>RG8A/U Coax, 50 Ohm</b>						
<b>PE33068</b>	1 piece price shown. See web or call for volume pricing.				0.405" dia.	8 dB/100ft 190 W
12"	24"	36"	48"	60"	72"	Custom Len.
\$104.96	\$101.85	\$104.68	\$107.52	\$110.35	\$120.62	See Web
<b>RG58C/U Coax, 50 Ohm</b>						
<b>PE3815</b>	1 piece price shown. See web or call for volume pricing.				0.195" dia.	20 dB/100ft 44 W
12"	24"	36"	48"	60"	72"	Custom Len.
\$103.25	\$104.06	\$104.88	\$105.74	\$106.56	\$107.39	See Web
<b>RG141A/U Coax, 50 Ohm</b>						
<b>PE34428</b>	1 piece price shown. See web or call for volume pricing.				0.190" dia.	13 dB/100ft 650 W
12"	24"	36"	48"	60"	72"	Custom Len.
\$122.46	\$121.98	\$136.26	\$134.89	\$150.60	\$157.64	See Web
<b>RG142B/U Coax, 50 Ohm</b>						
<b>PE3W03503</b>	1 piece price shown. See web or call for volume pricing.				0.195" dia.	13 dB/100ft 600 W
12"	24"	36"	48"	60"	50CM	Custom Len.
\$70.25	\$76.14	\$82.04	\$87.94	\$93.84	\$74.02	See Web
<b>PE3843</b>	1 piece price shown. See web or call for volume pricing.				0.195" dia.	13 dB/100ft 650 W
12"	24"	36"	48"	60"	72"	Custom Len.
\$96.35	\$96.63	\$108.50	\$108.10	\$121.14	\$127.33	See Web
<b>RG174A/U Coax, 50 Ohm</b>						
<b>PE33706</b>	1 piece price shown. See web or call for volume pricing.				0.100" dia.	32 dB/100ft 16 W
12"	24"	36"	48"	60"	72"	Custom Len.
\$115.95	\$109.82	\$117.11	\$117.72	\$118.30	\$111.56	See Web
<b>RG188A/U Coax, 50 Ohm</b>						
<b>PE34430</b>	1 piece price shown. See web or call for volume pricing.				0.110" dia.	26 dB/100ft 160 W
12"	24"	36"	48"	60"	72"	Custom Len.
\$117.86	\$120.36	\$115.63	\$117.85	\$120.07	\$130.57	See Web
<b>RG213/U Coax, 50 Ohm</b>						
<b>PE35384</b>	1 piece price shown. See web or call for volume pricing.				0.405" dia.	9 dB/100ft 190 W
12"	24"	36"	48"	60"	-	Custom Len.
\$99.12	\$100.91	\$102.69	\$104.59	\$106.40	-	See Web
<b>RG214/U Coax, 50 Ohm</b>						
<b>PE3117</b>	1 piece price shown. See web or call for volume pricing.				0.425" dia.	7 dB/100ft 170 W
12"	24"	36"	48"	60"	72"	Custom Len.
\$112.04	\$119.82	\$127.60	\$127.67	\$143.77	\$151.69	See Web
<b>RG223/U Coax, 50 Ohm</b>						
<b>PE3992</b>	1 piece price shown. See web or call for volume pricing.				0.210" dia.	13 dB/100ft 53 W
12"	24"	36"	48"	60"	72"	Custom Len.
\$91.63	\$94.75	\$97.86	\$101.16	\$99.71	\$107.51	See Web
<b>RG225/U Coax, 50 Ohm</b>						
<b>PE34421</b>	1 piece price shown. See web or call for volume pricing.				0.430" dia.	dB/100ft 1700 W
12"	24"	36"	48"	60"	72"	Custom Len.
\$132.41	\$168.04	\$203.66	\$222.69	\$277.68	\$287.87	See Web
<b>RG316/U Coax, 50 Ohm</b>						
<b>PE34432</b>	1 piece price shown. See web or call for volume pricing.				0.098" dia.	38 dB/100ft 160 W
12"	24"	36"	48"	60"	72"	Custom Len.
\$110.02	\$112.90	\$115.80	\$118.68	\$121.57	\$132.55	See Web
<b>RG393/U Coax, 50 Ohm</b>						



Part No.	Cable Dia.				Attn. @ 1 GHz	Power @ 1 GHz
<b>PE3338</b>	1 piece price shown. See web or call for volume pricing.				0.390" dia.	8 dB/100ft 1700 W
12"	24"	36"	48"	60"	72"	Custom Len.
\$109.98	\$132.98	\$149.39	\$166.75	\$171.85	\$187.32	See Web
<b>RG400/U Coax, 50 Ohm</b>						
<b>PE34424</b>	1 piece price shown. See web or call for volume pricing.				0.195" dia.	15 dB/100ft 650 W
12"	24"	36"	48"	60"	72"	Custom Len.
\$99.01	\$105.98	\$112.94	\$127.56	\$126.88	\$133.85	See Web
<b>PE-P195 Coax, 50 Ohm</b>						
<b>PE39229</b>	1 piece price shown. See web or call for volume pricing.				0.195" dia.	13 dB/100ft 650 W
12"	24"	36"	48"	60"	-	Custom Len.
\$71.96	\$76.74	\$85.60	\$94.45	\$103.30	-	See Web
<b>RG59B/U Coax, 75 Ohm</b>						
<b>PE3895</b>	1 piece price shown. See web or call for volume pricing.				0.242" dia.	12 dB/100ft 77 W
12"	24"	36"	48"	60"	72"	Custom Len.
\$91.58	\$92.62	\$93.66	\$94.75	\$95.81	\$96.87	See Web
<b>RG62A/U Coax, 93 Ohm</b>						
<b>PE3857</b>	1 piece price shown. See web or call for volume pricing.				0.242" dia.	13 dB/100ft 77 W
12"	24"	36"	48"	60"	72"	Custom Len.
\$95.68	\$97.23	\$98.77	\$100.40	\$97.50	\$103.54	See Web
<b>SHV PLUG TO SHV JACK BULKHEAD</b>						
SEE MOUNTING HOLE SECTION ON PAGE 369						
<b>Standard Flexible Cable Assemblies</b>						
<b>RG142B/U Coax, 50 Ohm</b>						
<b>PE3W03078</b>	1 piece price shown. See web or call for volume pricing.				0.195" dia.	dB/100ft 600 W
12"	24"	36"	48"	60"	50CM	Custom Len.
\$91.54	\$92.23	\$98.13	\$104.04	\$109.94	\$90.11	See Web
<b>SHV JACK BULKHEAD TO SHV PLUG</b>						
SEE MOUNTING HOLE SECTION ON PAGE 369						
<b>Standard Flexible Cable Assemblies</b>						
<b>RG59B/U Coax, 75 Ohm</b>						
<b>PE33018</b>	1 piece price shown. See web or call for volume pricing.				0.242" dia.	12 dB/100ft 77 W
12"	24"	36"	48"	60"	-	Custom Len.
\$106.10	\$107.14	\$108.18	\$109.27	\$110.33	-	See Web
<b>SMA MALE TO SMA MALE</b>						
<b>Standard Flexible Cable Assemblies</b>						
<b>M17/60-RG142-27478 Coax, 50 Ohm</b>						
<b>PE3M0023</b>	1 piece price shown. See web or call for volume pricing.				0.195" dia.	dB/100ft W
12"	18"	24"	30"	36"	48"	Custom Len.
\$218.62	\$221.34	\$224.07	\$226.79	\$229.53	\$234.98	See Web
<b>M17/84-RG223-0XDS2 Coax, 50 Ohm</b>						
<b>PE3M0051</b>	1 piece price shown. See web or call for volume pricing.				0.212" dia.	dB/100ft W
12"	18"	24"	30"	36"	48"	Custom Len.
\$222.92	\$227.79	\$232.67	\$237.55	\$242.43	\$252.19	See Web
<b>M17/128-RG400-27478 Coax, 50 Ohm</b>						
<b>PE3M0079</b>	1 piece price shown. See web or call for volume pricing.				0.195" dia.	dB/100ft W
12"	18"	24"	30"	36"	48"	Custom Len.
\$220.10	\$223.57	\$227.04	\$230.51	\$233.98	\$240.92	See Web
<b>M17/113-RG316-27478 Coax, 50 Ohm</b>						
<b>PE3M0090</b>	1 piece price shown. See web or call for volume pricing.				0.098" dia.	dB/100ft W
6"	8"	12"	16"	18"	24"	Custom Len.
\$173.17	\$173.49	\$174.17	\$174.83	\$175.18	\$176.17	See Web
<b>M17/119-RG174-0XDS2 Coax, 50 Ohm</b>						
<b>PE3M0105</b>	1 piece price shown. See web or call for volume pricing.				0.110" dia.	dB/100ft W
6"	8"	12"	16"	18"	24"	Custom Len.
\$172.56	\$172.68	\$172.94	\$173.20	\$173.34	\$173.72	See Web
<b>M17/28-RG058-0XDS2 Coax, 50 Ohm</b>						
<b>PE3M0119</b>	1 piece price shown. See web or call for volume pricing.				0.195" dia.	dB/100ft W
12"	18"	24"	30"	36"	48"	Custom Len.
\$323.12	\$323.71	\$324.31	\$324.91	\$325.51	\$326.70	See Web



Cable Assemblies

See Our Website For Current Pricing & Real-Time Stock Availability!

Continued on Next Page

For Custom Lengths, Metric Lengths or Special Configurations, Please call (949) 261-1920



Technical Support  
+1 (949) 261-1920



Same-Day Shipping,  
Even Custom Cable Assemblies

For our complete selection of cable assemblies, please visit our website

**SMA MALE TO SMA MALE RIGHT ANGLE**



Part No. <a href="#">PE3M0122</a>	Cable Dia.	Attn. @ 1 GHz	Power @ 1 GHz
1 piece price shown. See web or call for volume pricing.	0.195" dia.	dB/100ft	W
12" 18" 24" 30"	36"	48"	Custom Len.
\$291.52 \$292.11 \$292.72 \$293.31	\$293.91	\$295.11	See Web

82

**Standard Flexible Cable Assemblies**

**M17/60-RG142-27478 Coax, 50 Ohm**

Part No. <a href="#">PE3M0024</a>	Cable Dia.	Attn. @ 1 GHz	Power @ 1 GHz
1 piece price shown. See web or call for volume pricing.	0.195" dia.	dB/100ft	W
12" 18" 24" 30"	36"	48"	Custom Len.
\$254.70 \$257.42 \$260.32 \$262.88	\$265.61	\$271.06	See Web

69

**M17/84-RG223-0XDS2 Coax, 50 Ohm**

Part No. <a href="#">PE3M0052</a>	Cable Dia.	Attn. @ 1 GHz	Power @ 1 GHz
1 piece price shown. See web or call for volume pricing.	0.212" dia.	dB/100ft	W
12" 18" 24" 30"	36"	48"	Custom Len.
\$259.00 \$263.87 \$268.76 \$273.63	\$278.51	\$288.27	See Web

70

**M17/128-RG400-27478 Coax, 50 Ohm**

Part No. <a href="#">PE3M0080</a>	Cable Dia.	Attn. @ 1 GHz	Power @ 1 GHz
1 piece price shown. See web or call for volume pricing.	0.195" dia.	dB/100ft	W
12" 18" 24" 30"	36"	48"	Custom Len.
\$256.19 \$259.65 \$263.13 \$266.59	\$270.07	\$277.01	See Web

71

**M17/113-RG316-27478 Coax, 50 Ohm**

Part No. <a href="#">PE3M0091</a>	Cable Dia.	Attn. @ 1 GHz	Power @ 1 GHz
1 piece price shown. See web or call for volume pricing.	0.098" dia.	dB/100ft	W
6" 8" 12" 16"	18"	24"	Custom Len.
\$189.04 \$189.36 \$190.03 \$190.70	\$191.04	\$192.04	See Web

72

**M17/119-RG174-0XDS2 Coax, 50 Ohm**

Part No. <a href="#">PE3M0106</a>	Cable Dia.	Attn. @ 1 GHz	Power @ 1 GHz
1 piece price shown. See web or call for volume pricing.	0.110" dia.	dB/100ft	W
6" 8" 12" 16"	18"	24"	Custom Len.
\$188.42 \$188.54 \$188.81 \$189.06	\$189.20	\$189.59	See Web

73

**M17/28-RG058-0XDS2 Coax, 50 Ohm**

Part No. <a href="#">PE3M0120</a>	Cable Dia.	Attn. @ 1 GHz	Power @ 1 GHz
1 piece price shown. See web or call for volume pricing.	0.195" dia.	dB/100ft	W
12" 18" 24" 30"	36"	48"	Custom Len.
\$262.45 \$263.04 \$263.65 \$264.24	\$264.84	\$266.04	See Web

74

**SMA MALE TO SMA FEMALE BULKHEAD**

SEE MOUNTING HOLE SECTION ON PAGE 369



**Standard Flexible Cable Assemblies**

**M17/113-RG316-27478 Coax, 50 Ohm**

Part No. <a href="#">PE3M0092</a>	Cable Dia.	Attn. @ 1 GHz	Power @ 1 GHz
1 piece price shown. See web or call for volume pricing.	0.098" dia.	dB/100ft	W
6" 8" 12" 16"	18"	24"	Custom Len.
\$179.79 \$180.11 \$180.79 \$181.45	\$181.79	\$182.79	See Web

75

**M17/119-RG174-0XDS2 Coax, 50 Ohm**

Part No. <a href="#">PE3M0107</a>	Cable Dia.	Attn. @ 1 GHz	Power @ 1 GHz
1 piece price shown. See web or call for volume pricing.	0.110" dia.	dB/100ft	W
6" 8" 12" 16"	18"	24"	Custom Len.
\$179.18 \$179.30 \$179.56 \$179.82	\$179.95	\$180.34	See Web

76

**SMA MALE TO TNC MALE**



**Standard Flexible Cable Assemblies**

**M17/60-RG142-27478 Coax, 50 Ohm**

Part No. <a href="#">PE3M0026</a>	Cable Dia.	Attn. @ 1 GHz	Power @ 1 GHz
1 piece price shown. See web or call for volume pricing.	0.195" dia.	dB/100ft	W
12" 18" 24" 30"	36"	48"	Custom Len.
\$187.90 \$190.63 \$193.36 \$196.08	\$198.81	\$204.27	See Web

77

**M17/84-RG223-0XDS2 Coax, 50 Ohm**

Part No. <a href="#">PE3M0054</a>	Cable Dia.	Attn. @ 1 GHz	Power @ 1 GHz
1 piece price shown. See web or call for volume pricing.	0.212" dia.	dB/100ft	W
12" 18" 24" 30"	36"	48"	Custom Len.
\$192.20 \$197.08 \$201.96 \$206.83	\$211.72	\$221.47	See Web

78

**M17/128-RG400-27478 Coax, 50 Ohm**

Part No. <a href="#">PE3M0082</a>	Cable Dia.	Attn. @ 1 GHz	Power @ 1 GHz
1 piece price shown. See web or call for volume pricing.	0.195" dia.	dB/100ft	W
12" 18" 24" 30"	36"	48"	Custom Len.
\$189.39 \$192.86 \$196.33 \$199.80	\$203.27	\$210.21	See Web

79

**M17/113-RG316-27478 Coax, 50 Ohm**

Part No. <a href="#">PE3M0096</a>	Cable Dia.	Attn. @ 1 GHz	Power @ 1 GHz
1 piece price shown. See web or call for volume pricing.	0.098" dia.	dB/100ft	W
6" 8" 12" 16"	18"	24"	Custom Len.
\$180.75 \$181.08 \$181.75 \$182.42	\$182.76	\$183.76	See Web

80

**M17/119-RG174-0XDS2 Coax, 50 Ohm**

Part No. <a href="#">PE3M0111</a>	Cable Dia.	Attn. @ 1 GHz	Power @ 1 GHz
1 piece price shown. See web or call for volume pricing.	0.110" dia.	dB/100ft	W
6" 8" 12" 16"	18"	24"	Custom Len.
\$180.14 \$180.26 \$180.53 \$180.78	\$180.92	\$181.31	See Web

81

**M17/28-RG058-0XDS2 Coax, 50 Ohm**

**SMA MALE TO 1.85MM MALE**



**Standard Formable Cable Assemblies**

**PE-SR405FL Coax, 50 Ohm**

Part No. <a href="#">PE36541</a>	Cable Dia.	Attn. @ 1 GHz	Power @ 1 GHz
1 piece price shown. See web or call for volume pricing.	" dia.	23 dB/100ft	130 W
6" 12" 18" 24"	36"	48"	Custom Len.
\$194.44 \$194.44 \$211.78 \$205.13	\$215.83	\$226.51	See Web

83

**Standard Semi-Rigid Cable Assemblies**

**RG405/U Coax, 50 Ohm**

Part No. <a href="#">PE36539</a>	Cable Dia.	Attn. @ 1 GHz	Power @ 1 GHz
1 piece price shown. See web or call for volume pricing.	" dia.	22 dB/100ft	130 W
6" 12" 18" 24"	36"	48"	Custom Len.
\$198.31 \$190.49 \$193.94 \$197.37	\$204.24	\$211.10	See Web

84

**SMA MALE TO 7/16 DIN MALE**



**Low PIM Formable Cable Assemblies**

**PE-SR402FLJ Low PIM Coax, 50 Ohm**

Part No. <a href="#">PE3C2007</a>	Cable Dia.	Attn. @ 1 GHz	Power @ 1 GHz
1 piece price shown. See web or call for volume pricing.	0.161" dia.	dB/100ft	W
100CM 200CM	-	-	Custom Len.
\$108.59 \$117.38	-	-	See Web

85

**Standard Formable Cable Assemblies**

**PE-SR401FL Coax, 50 Ohm**

Part No. <a href="#">PE36169</a>	Cable Dia.	Attn. @ 1 GHz	Power @ 1 GHz
1 piece price shown. See web or call for volume pricing.	" dia.	8 dB/100ft	1400 W
12" 24" 36" 48"	60"	72"	Custom Len.
\$222.33 \$237.27 \$252.22 \$267.16	\$282.11	\$297.04	See Web

86

**Standard Flexible Cable Assemblies**

**RG8A/U Coax, 50 Ohm**

Part No. <a href="#">PE36157</a>	Cable Dia.	Attn. @ 1 GHz	Power @ 1 GHz
1 piece price shown. See web or call for volume pricing.	0.405" dia.	8 dB/100ft	190 W
12" 24" 36" 48"	60"	72"	Custom Len.
\$213.08 \$215.84 \$218.54 \$221.31	\$224.06	\$226.77	See Web

87

**RG142B/U Coax, 50 Ohm**

Part No. <a href="#">PE3224</a>	Cable Dia.	Attn. @ 1 GHz	Power @ 1 GHz
1 piece price shown. See web or call for volume pricing.	0.195" dia.	13 dB/100ft	W
12" 24" 36" 48"	60"	72"	Custom Len.
\$70.65 \$76.19 \$81.71 \$87.29	\$92.81	\$98.38	See Web

88

**RG223/U Coax, 50 Ohm**

Part No. <a href="#">PE36161</a>	Cable Dia.	Attn. @ 1 GHz	Power @ 1 GHz
1 piece price shown. See web or call for volume pricing.	0.210" dia.	8 dB/100ft	53 W
12" 24" 36" 48"	60"	72"	Custom Len.
\$68.01 \$75.20 \$73.84 \$76.78	\$79.67	\$82.60	See Web

89

**SMA MALE TO BNC MALE**



**Flexible Cable Assemblies**

**LMR-240 Coax, 50 Ohm**

Part No. <a href="#">PE3C1830</a>	Cable Dia.	Attn. @ 1 GHz	Power @ 1 GHz
1 piece price shown. See web or call for volume pricing.	0.240" dia.	8 dB/100ft	W
12" 24" 36" 48"	60"	50CM	Custom Len.
\$38.45 \$39.40 \$40.34 \$41.29	\$42.24	\$39.06	See Web

90

**Low Loss Flexible Cable Assemblies**

**LMR-195 Coax, 50 Ohm**

Part No. <a href="#">PE3C0051</a>	Cable Dia.	Attn. @ 1 GHz	Power @ 1 GHz
1 piece price shown. See web or call for volume pricing.	0.195" dia.	12 dB/100ft	W
12" 24" 36" 48"	60"	-	Custom Len.
\$33.11 \$33.86 \$34.61 \$35.41	\$36.17	-	See Web

91

**Standard Formable Cable Assemblies**

**PE-SR402FL Coax, 50 Ohm**

Part No. <a href="#">PE34008</a>	Cable Dia.	Attn. @ 1 GHz	Power @ 1 GHz
1 piece price shown. See web or call for volume pricing.	" dia.	12 dB/100ft	450 W
12" 24" 36" 48"	60"	-	Custom Len.
\$69.34 \$77.43 \$79.28 \$86.82	\$102.29	-	See Web

92

**PE-SR405FL Coax, 50 Ohm**

Part No. <a href="#">PE35109</a>	Cable Dia.	Attn. @ 1 GHz	Power @ 1 GHz
1 piece price shown. See web or call for volume pricing.	" dia.	23 dB/100ft	130 W
12" 24" 36" 48"	60"	-	Custom Len.
\$70.06 \$81.66 \$93.25 \$104.85	\$116.44	-	See Web

93

\*Coax Performance at 1 GHz Notes: Cable assembly max frequency may be lower than connector or coax max frequency

Cable Assemblies

See Our Website For Current Pricing & Real-Time Stock Availability!

For our complete selection of cable assemblies, please visit our website

Standard Flexible Cable Assemblies						
<b>RG58C/U Coax, 50 Ohm</b>						
Part No. <b>PE3615</b>	Cable Dia.			Attn. @ 1 GHz	Power @ 1 GHz	
1 piece price shown. See web or call for volume pricing.						
12"	24"	36"	48"	0.195" dia.	20 dB/100ft	44 W
\$39.92	\$40.73	\$41.54	\$42.40	\$43.23	\$44.06	Custom Len. See Web
<b>RG142B/U Coax, 50 Ohm</b>						
Part No. <b>PE3696</b>	Cable Dia.			Attn. @ 1 GHz	Power @ 1 GHz	
1 piece price shown. See web or call for volume pricing.						
12"	24"	36"	48"	0.195" dia.	13 dB/100ft	650 W
\$39.24	\$48.46	\$54.54	\$60.97	\$67.17	\$73.36	Custom Len. See Web
<b>RG174A/U Coax, 50 Ohm</b>						
Part No. <b>PE3C3328</b>	Cable Dia.			Attn. @ 1 GHz	Power @ 1 GHz	
1 piece price shown. See web or call for volume pricing.						
12"	24"	36"	48"	0.110" dia.	32 dB/100ft	17 W
\$40.44	\$41.02	\$41.60	\$42.20	\$42.80	\$43.39	Custom Len. See Web
<b>RG178B/U Coax, 50 Ohm</b>						
Part No. <b>PE33258</b>	Cable Dia.			Attn. @ 1 GHz	Power @ 1 GHz	
1 piece price shown. See web or call for volume pricing.						
12"	24"	36"	48"	0.072" dia.	44 dB/100ft	78 W
\$66.25	\$67.31	\$68.37	\$69.49	\$66.34	\$71.65	Custom Len. See Web
<b>RG188A/U Coax, 50 Ohm</b>						
Part No. <b>PE3C2035</b>	Cable Dia.			Attn. @ 1 GHz	Power @ 1 GHz	
1 piece price shown. See web or call for volume pricing.						
12"	24"	36"	48"	0.110" dia.	26 dB/100ft	160 W
\$41.41	\$43.91	\$46.40	\$49.04	\$47.94	\$54.12	Custom Len. See Web
<b>RG196A/U Coax, 50 Ohm</b>						
Part No. <b>PE33523</b>	Cable Dia.			Attn. @ 1 GHz	Power @ 1 GHz	
1 piece price shown. See web or call for volume pricing.						
12"	24"	36"	48"	0.080" dia.	49 dB/100ft	78 W
\$69.19	\$70.60	\$66.81	\$68.18	\$69.54	\$70.92	Custom Len. See Web
<b>RG214/U Coax, 50 Ohm</b>						
Part No. <b>PE33519</b>	Cable Dia.			Attn. @ 1 GHz	Power @ 1 GHz	
1 piece price shown. See web or call for volume pricing.						
12"	24"	36"	48"	0.425" dia.	7 dB/100ft	190 W
\$126.36	\$133.73	\$141.13	\$148.49	\$155.88	\$163.27	Custom Len. See Web
<b>RG223/U Coax, 50 Ohm</b>						
Part No. <b>PE3562</b>	Cable Dia.			Attn. @ 1 GHz	Power @ 1 GHz	
1 piece price shown. See web or call for volume pricing.						
12"	24"	36"	48"	0.210" dia.	13 dB/100ft	53 W
\$38.03	\$40.93	\$43.84	\$46.73	\$49.62	\$52.52	Custom Len. See Web
<b>RG316/U Coax, 50 Ohm</b>						
Part No. <b>PE3C2360</b>	Cable Dia.			Attn. @ 1 GHz	Power @ 1 GHz	
1 piece price shown. See web or call for volume pricing.						
12"	24"	36"	48"	0.098" dia.	58 dB/100ft	160 W
\$37.56	\$40.68	\$43.80	\$47.11	\$50.30	\$53.49	Custom Len. See Web
<b>RG400/U Coax, 50 Ohm</b>						
Part No. <b>PE3613</b>	Cable Dia.			Attn. @ 1 GHz	Power @ 1 GHz	
1 piece price shown. See web or call for volume pricing.						
12"	24"	36"	48"	0.195" dia.	15 dB/100ft	650 W
\$50.17	\$57.57	\$64.97	\$72.79	\$80.34	\$82.18	Custom Len. See Web
<b>PE-195 Coax, 50 Ohm</b>						
Part No. <b>PE33989</b>	Cable Dia.			Attn. @ 1 GHz	Power @ 1 GHz	
1 piece price shown. See web or call for volume pricing.						
12"	24"	36"	48"	0.195" dia.	13 dB/100ft	650 W
\$48.56	\$58.14	\$67.71	\$77.85	\$87.62	-	Custom Len. See Web
<b>RG55B/U Coax, 53 Ohm</b>						
Part No. <b>PE3479</b>	Cable Dia.			Attn. @ 1 GHz	Power @ 1 GHz	
1 piece price shown. See web or call for volume pricing.						
12"	24"	36"	48"	0.202" dia.	17 dB/100ft	53 W
\$36.28	\$41.05	\$43.64	\$46.38	\$49.02	\$51.66	Custom Len. See Web
<b>RG59B/U Coax, 75 Ohm</b>						
Part No. <b>PE3539</b>	Cable Dia.			Attn. @ 1 GHz	Power @ 1 GHz	
1 piece price shown. See web or call for volume pricing.						
12"	24"	36"	48"	0.242" dia.	12 dB/100ft	77 W
\$52.16	\$50.16	\$51.13	\$52.09	\$53.04	\$57.45	Custom Len. See Web
<b>RG179B/U Coax, 75 Ohm</b>						
Part No. <b>PE3C3321</b>	Cable Dia.			Attn. @ 1 GHz	Power @ 1 GHz	
1 piece price shown. See web or call for volume pricing.						
12"	24"	36"	48"	0.100" dia.	29 dB/100ft	240 W
\$42.38	\$41.60	\$43.97	\$46.33	\$48.69	\$51.07	Custom Len. See Web

**SMA MALE TO BNC MALE RIGHT ANGLE**



**Low Loss Flexible Cable Assemblies**

LMR-195 Coax, 50 Ohm						
Part No. <b>PE3C0040</b>	Cable Dia.			Attn. @ 1 GHz	Power @ 1 GHz	
1 piece price shown. See web or call for volume pricing.						
12"	24"	36"	48"	0.195" dia.	12 dB/100ft	W
\$46.83	\$47.58	\$48.33	\$49.12	\$49.88	-	Custom Len. See Web

**SMA MALE TO FAKRA PLUG**



**Low Loss Flexible Cable Assemblies**

PE-C100-LSZH Coax, 50 Ohm						
Part No. <b>PE39342A</b>	Cable Dia.			Attn. @ 1 GHz	Power @ 1 GHz	
1 piece price shown. See web or call for volume pricing.						
12"	24"	36"	48"	0.109" dia.	25 dB/100ft	W
\$31.11	\$35.54	\$32.54	\$33.21	\$33.92	-	Custom Len. See Web
Part No. <b>PE39342C</b>	Cable Dia.			Attn. @ 1 GHz	Power @ 1 GHz	
1 piece price shown. See web or call for volume pricing.						
12"	24"	36"	48"	0.109" dia.	25 dB/100ft	W
\$34.22	\$35.43	\$36.64	\$37.84	\$39.05	-	Custom Len. See Web
Part No. <b>PE39342Z</b>	Cable Dia.			Attn. @ 1 GHz	Power @ 1 GHz	
1 piece price shown. See web or call for volume pricing.						
12"	24"	36"	48"	0.109" dia.	25 dB/100ft	W
\$36.97	\$35.43	\$36.64	\$37.84	\$42.37	-	Custom Len. See Web

**Standard Flexible Cable Assemblies**

RG174A/U Coax, 50 Ohm						
Part No. <b>PE39197C</b>	Cable Dia.			Attn. @ 1 GHz	Power @ 1 GHz	
1 piece price shown. See web or call for volume pricing.						
12"	24"	36"	48"	0.100" dia.	32 dB/100ft	16 W
\$43.02	\$40.27	\$40.70	\$41.13	\$41.58	-	Custom Len. See Web
Part No. <b>PE39197D</b>	Cable Dia.			Attn. @ 1 GHz	Power @ 1 GHz	
1 piece price shown. See web or call for volume pricing.						
12"	24"	36"	48"	0.100" dia.	32 dB/100ft	16 W
\$43.02	\$40.27	\$40.70	\$41.13	\$41.58	-	Custom Len. See Web
Part No. <b>PE39197H</b>	Cable Dia.			Attn. @ 1 GHz	Power @ 1 GHz	
1 piece price shown. See web or call for volume pricing.						
12"	24"	36"	48"	0.100" dia.	32 dB/100ft	16 W
\$36.21	\$36.76	\$37.29	\$37.77	\$38.31	-	Custom Len. See Web
Part No. <b>PE39197I</b>	Cable Dia.			Attn. @ 1 GHz	Power @ 1 GHz	
1 piece price shown. See web or call for volume pricing.						
12"	24"	36"	48"	0.100" dia.	32 dB/100ft	16 W
\$36.21	\$36.76	\$37.29	\$37.77	\$38.31	-	Custom Len. See Web
Part No. <b>PE39197Z</b>	Cable Dia.			Attn. @ 1 GHz	Power @ 1 GHz	
1 piece price shown. See web or call for volume pricing.						
12"	24"	36"	48"	0.100" dia.	32 dB/100ft	16 W
\$43.81	\$44.40	\$40.70	\$41.13	\$41.58	-	Custom Len. See Web
<b>RG316/U Coax, 50 Ohm</b>						
Part No. <b>PE39343A</b>	Cable Dia.			Attn. @ 1 GHz	Power @ 1 GHz	
1 piece price shown. See web or call for volume pricing.						
12"	24"	36"	48"	0.098" dia.	38 dB/100ft	160 W
\$42.47	\$45.36	\$48.26	\$51.14	\$54.03	-	Custom Len. See Web
Part No. <b>PE39343C</b>	Cable Dia.			Attn. @ 1 GHz	Power @ 1 GHz	
1 piece price shown. See web or call for volume pricing.						
12"	24"	36"	48"	0.098" dia.	38 dB/100ft	160 W
\$46.72	\$45.36	\$48.26	\$51.14	\$54.03	-	Custom Len. See Web
Part No. <b>PE39343D</b>	Cable Dia.			Attn. @ 1 GHz	Power @ 1 GHz	
1 piece price shown. See web or call for volume pricing.						
12"	24"	36"	48"	0.098" dia.	38 dB/100ft	160 W
\$46.24	\$44.92	\$47.80	\$50.69	\$53.57	-	Custom Len. See Web
Part No. <b>PE39343I</b>	Cable Dia.			Attn. @ 1 GHz	Power @ 1 GHz	
1 piece price shown. See web or call for volume pricing.						
12"	24"	36"	48"	0.098" dia.	38 dB/100ft	160 W
\$38.61	\$41.42	\$44.31	\$47.20	\$50.07	-	Custom Len. See Web
Part No. <b>PE39343Z</b>	Cable Dia.			Attn. @ 1 GHz	Power @ 1 GHz	
1 piece price shown. See web or call for volume pricing.						
12"	24"	36"	48"	0.098" dia.	38 dB/100ft	160 W
\$46.72	\$45.36	\$48.26	\$51.14	\$54.03	-	Custom Len. See Web

**SMA MALE TO FAKRA JACK**



**Low Loss Flexible Cable Assemblies**

PE-C100-LSZH Coax, 50 Ohm						
Part No. <b>PE39347A</b>	Cable Dia.			Attn. @ 1 GHz	Power @ 1 GHz	
1 piece price shown. See web or call for volume pricing.						
12"	24"	36"	48"	0.109" dia.	25 dB/100ft	W
\$35.41	\$36.61	\$41.60	\$39.01	\$40.24	-	Custom Len. See Web
Part No. <b>PE39347C</b>	Cable Dia.			Attn. @ 1 GHz	Power @ 1 GHz	
1 piece price shown. See web or call for volume pricing.						
12"	24"	36"	48"	0.109" dia.	25 dB/100ft	W
\$35.41	\$36.61	\$41.60	\$39.01	\$40.24	-	Custom Len. See Web
Part No. <b>PE39347Z</b>	Cable Dia.			Attn. @ 1 GHz	Power @ 1 GHz	
1 piece price shown. See web or call for volume pricing.						
12"	24"	36"	48"	0.109" dia.	25 dB/100ft	W
\$36.29	\$37.61	\$38.94	\$37.22	\$38.42	-	Custom Len. See Web

**Standard Flexible Cable Assemblies**

Cable Assemblies

See Our Website For Current Pricing & Real-Time Stock Availability!

Continued on Next Page

For Custom Lengths, Metric Lengths or Special Configurations, Please call (949) 261-1920



Technical Support  
+1 (949) 261-1920



Same-Day Shipping,  
Even Custom Cable Assemblies

For our complete selection of cable assemblies, please visit our website

Cable Assemblies  
See Our Website For Current Pricing & Real-Time Stock Availability!

RG174A/U Coax, 50 Ohm						
Part No.	Cable Dia.				Attn. @ 1 GHz	Power @ 1 GHz
Part No. <a href="#">PE39199A</a>	1 piece price shown. See web or call for volume pricing.				0.100" dia.	32 dB/100ft 16 W
12"	24"	36"	48"	60"	-	Custom Len.
\$43.02	\$40.27	\$40.70	\$41.13	\$41.58	-	See Web
Part No. <a href="#">PE39199C</a>						
Part No. <a href="#">PE39199D</a>	1 piece price shown. See web or call for volume pricing.				0.100" dia.	32 dB/100ft 16 W
12"	24"	36"	48"	60"	-	Custom Len.
\$39.84	\$43.60	\$40.70	\$44.79	\$41.58	-	See Web
Part No. <a href="#">PE39199H</a>						
Part No. <a href="#">PE39199I</a>	1 piece price shown. See web or call for volume pricing.				0.100" dia.	32 dB/100ft 16 W
12"	24"	36"	48"	60"	-	Custom Len.
\$36.21	\$36.76	\$37.29	\$37.77	\$38.31	-	See Web
Part No. <a href="#">PE39199K</a>						
Part No. <a href="#">PE39199Z</a>	1 piece price shown. See web or call for volume pricing.				0.100" dia.	32 dB/100ft 16 W
12"	24"	36"	48"	60"	-	Custom Len.
\$43.02	\$43.60	\$44.18	\$44.79	\$45.38	-	See Web
RG316/U Coax, 50 Ohm						
Part No. <a href="#">PE39348A</a>	1 piece price shown. See web or call for volume pricing.				0.098" dia.	38 dB/100ft 160 W
12"	24"	36"	48"	60"	-	Custom Len.
\$42.47	\$45.36	\$48.26	\$51.14	\$54.03	-	See Web
Part No. <a href="#">PE39348B</a>						
Part No. <a href="#">PE39348C</a>	1 piece price shown. See web or call for volume pricing.				0.098" dia.	38 dB/100ft 160 W
12"	24"	36"	48"	60"	-	Custom Len.
\$45.87	\$49.00	\$48.26	\$51.14	\$58.61	-	See Web
Part No. <a href="#">PE39348H</a>						
Part No. <a href="#">PE39348K</a>	1 piece price shown. See web or call for volume pricing.				0.098" dia.	38 dB/100ft 160 W
12"	24"	36"	48"	60"	-	Custom Len.
\$42.47	\$49.85	\$52.97	\$51.14	\$54.03	-	See Web
Part No. <a href="#">PE39348Z</a>						
Part No. <a href="#">PE39348Z</a>	1 piece price shown. See web or call for volume pricing.				0.098" dia.	38 dB/100ft 160 W
12"	24"	36"	48"	60"	-	Custom Len.
\$45.87	\$45.36	\$48.26	\$55.43	\$58.61	-	See Web
SMA MALE TO MC-CARD PLUG						
Standard Flexible Cable Assemblies						
RG174A/U Coax, 50 Ohm						
Part No. <a href="#">PE36112</a>	1 piece price shown. See web or call for volume pricing.				0.100" dia.	32 dB/100ft 16 W
12"	24"	36"	48"	60"	72"	Custom Len.
\$40.65	\$41.12	\$41.57	\$41.98	\$42.45	\$42.87	See Web
RG316/U Coax, 50 Ohm						
Part No. <a href="#">PE36108</a>	1 piece price shown. See web or call for volume pricing.				0.098" dia.	38 dB/100ft 160 W
12"	24"	36"	48"	60"	72"	Custom Len.
\$47.54	\$46.24	\$49.23	\$52.24	\$55.23	\$58.23	See Web
SMA MALE TO MINI UHF MALE						
Standard Flexible Cable Assemblies						
RG58C/U Coax, 50 Ohm						
Part No. <a href="#">PE3273</a>	1 piece price shown. See web or call for volume pricing.				0.195" dia.	20 dB/100ft 44 W
12"	24"	36"	48"	60"	72"	Custom Len.
\$38.64	\$39.38	\$40.12	\$40.85	\$41.59	\$42.33	See Web
RG142B/U Coax, 50 Ohm						
Part No. <a href="#">PE3275</a>	1 piece price shown. See web or call for volume pricing.				0.195" dia.	13 dB/100ft W
12"	24"	36"	48"	60"	72"	Custom Len.
\$38.59	\$44.32	\$50.06	\$55.79	\$61.52	\$67.25	See Web

RG223/U Coax, 50 Ohm						
Part No.	Cable Dia.				Attn. @ 1 GHz	Power @ 1 GHz
Part No. <a href="#">PE3271</a>	1 piece price shown. See web or call for volume pricing.				0.209" dia.	13 dB/100ft 50 W
12"	24"	36"	48"	60"	72"	Custom Len.
\$40.04	\$39.31	\$42.20	\$45.10	\$48.00	\$50.90	See Web
RG400/U Coax, 50 Ohm						
Part No. <a href="#">PE3278</a>	1 piece price shown. See web or call for volume pricing.				0.195" dia.	15 dB/100ft 600 W
12"	24"	36"	48"	60"	72"	Custom Len.
\$43.17	\$50.20	\$57.21	\$64.24	\$71.27	\$78.29	See Web
SMA MALE TO MMCX PLUG						
Standard Flexible Cable Assemblies						
RG174A/U Coax, 50 Ohm						
Part No. <a href="#">PE34069</a>	1 piece price shown. See web or call for volume pricing.				0.100" dia.	32 dB/100ft 16 W
12"	24"	36"	48"	60"	72"	Custom Len.
\$52.94	\$53.52	\$54.10	\$54.71	\$50.76	\$51.19	See Web
RG178B/U Coax, 50 Ohm						
Part No. <a href="#">PE34374</a>	1 piece price shown. See web or call for volume pricing.				0.072" dia.	44 dB/100ft 78 W
12"	24"	36"	48"	60"	72"	Custom Len.
\$60.94	\$62.00	\$58.35	\$59.31	\$60.26	\$66.34	See Web
RG188A/U Coax, 50 Ohm						
Part No. <a href="#">PE34887</a>	1 piece price shown. See web or call for volume pricing.				0.110" dia.	26 dB/100ft 160 W
12"	24"	36"	48"	60"	72"	Custom Len.
\$55.96	\$58.45	\$60.95	\$63.59	\$59.73	\$61.96	See Web
RG316/U Coax, 50 Ohm						
Part No. <a href="#">PE34122</a>	1 piece price shown. See web or call for volume pricing.				0.098" dia.	38 dB/100ft 160 W
12"	24"	36"	48"	60"	72"	Custom Len.
\$54.98	\$58.11	\$61.24	\$64.54	\$62.46	\$70.91	See Web
SMA MALE TO MMCX PLUG RIGHT ANGLE						
Standard Formable Cable Assemblies						
PE-SR405FLJ Coax, 50 Ohm						
Part No. <a href="#">PE39564</a>	1 piece price shown. See web or call for volume pricing.				0.098" dia.	20 dB/100ft 130 W
6"	9"	12"	24"	-	-	Custom Len.
\$41.54	\$39.46	\$41.54	\$50.52	-	-	See Web
Standard Flexible Cable Assemblies						
RG178B/U Coax, 50 Ohm						
Part No. <a href="#">PE34777</a>	1 piece price shown. See web or call for volume pricing.				0.072" dia.	44 dB/100ft 78 W
12"	24"	36"	48"	60"	-	Custom Len.
\$66.12	\$67.18	\$68.24	\$69.36	\$70.44	-	See Web
SMA MALE TO N MALE						
Flexible Cable Assemblies						
LMR-240 Coax, 50 Ohm						
Part No. <a href="#">PE3C1982</a>	1 piece price shown. See web or call for volume pricing.				0.240" dia.	8 dB/100ft W
12"	24"	36"	48"	60"	50CM	Custom Len.
\$38.45	\$39.39	\$40.33	\$41.28	\$42.22	\$39.06	See Web
LMR-195 Coax, 50 Ohm						
Part No. <a href="#">PE3C0121</a>	1 piece price shown. See web or call for volume pricing.				0.195" dia.	12 dB/100ft W
12"	24"	36"	48"	60"	-	Custom Len.
\$46.85	\$47.61	\$48.36	\$49.14	\$49.90	-	See Web
Precision Formable Cable Assemblies						
PE-80TEST Coax, 50 Ohm						
Part No. <a href="#">PE3TC0105</a>	1 piece price shown. See web or call for volume pricing.				0.195" dia.	dB/100ft W
24"	48"	72"	-	-	-	Custom Len.
\$329.78	\$415.52	\$501.27	-	-	-	See Web
PE-90TEST Coax, 50 Ohm						
Part No. <a href="#">PE3TC0303</a>	1 piece price shown. See web or call for volume pricing.				0.151" dia.	dB/100ft W
24"	48"	72"	-	-	-	Custom Len.
\$269.58	\$344.28	\$422.23	-	-	-	See Web
Low Loss Flexible Cable Assemblies						
PE-C100-LSZH Coax, 50 Ohm						

\*Coax Performance at 1 GHz Notes: Cable assembly max frequency may be lower than connector or coax max frequency

# For our complete selection of cable assemblies, please visit our website

Part No.	Cable Dia.				Attn. @ 1 GHz	Power @ 1 GHz
<b>PE38433</b>	0.109" dia.				25 dB/100ft	W
1 piece price shown. See web or call for volume pricing.	12"	24"	36"	48"	60"	Custom Len.
	\$42.27	\$44.25	\$46.29	\$50.55	\$50.32	- See Web
<b>PE-C195 Coax, 50 Ohm</b>						
<b>PE35981</b>	0.195" dia.				11 dB/100ft	150 W
1 piece price shown. See web or call for volume pricing.	12"	24"	36"	48"	60"	Custom Len.
	\$41.40	\$42.18	\$42.97	\$43.79	\$44.59	- See Web
<b>PE-C200 Coax, 50 Ohm</b>						
<b>PE36200</b>	0.195" dia.				11 dB/100ft	170 W
1 piece price shown. See web or call for volume pricing.	12"	24"	36"	48"	60"	Custom Len.
	\$42.01	\$45.36	\$46.19	\$52.29	\$56.49	- See Web
<b>PE-C240 Coax, 50 Ohm</b>						
<b>PE38645</b>	0.240" dia.				9 dB/100ft	250 W
1 piece price shown. See web or call for volume pricing.	12"	24"	36"	48"	60"	Custom Len.
	\$52.90	\$57.21	\$58.34	\$59.25	\$60.70	- See Web
<b>LMR-240 Coax, 50 Ohm</b>						
<b>PE3C0044</b>	0.240" dia.				8 dB/100ft	W
1 piece price shown. See web or call for volume pricing.	12"	24"	36"	48"	60"	Custom Len.
	\$53.51	\$54.49	\$55.46	\$54.36	\$55.34	- See Web
<b>LMR-400 Coax, 50 Ohm</b>						
<b>PE3C0102</b>	0.240" dia.				8 dB/100ft	W
1 piece price shown. See web or call for volume pricing.	12"	24"	36"	48"	60"	Custom Len.
	\$41.52	\$42.50	\$43.47	\$44.50	\$45.50	- See Web
<b>PE-P142LL Coax, 50 Ohm</b>						
<b>PE3W00832</b>	0.405" dia.				4 dB/100ft	W
1 piece price shown. See web or call for volume pricing.	12"	24"	36"	48"	60"	50CM Custom Len.
	\$60.71	\$62.04	\$63.37	\$64.70	\$66.04	\$61.56 See Web
<b>PE-P142LL-27478 Coax, 50 Ohm</b>						
<b>PE3C0689</b>	0.195" dia.				7 dB/100ft	W
1 piece price shown. See web or call for volume pricing.	12"	24"	36"	48"	60"	50CM Custom Len.
	\$128.26	\$144.50	\$160.73	\$176.97	\$193.21	\$138.66 See Web
<b>PE-P160LL-27478 Coax, 50 Ohm</b>						
<b>PE3M0132</b>	0.195" dia.				dB/100ft	W
1 piece price shown. See web or call for volume pricing.	12"	18"	24"	36"	48"	60" Custom Len.
	\$358.92	\$367.40	\$375.88	\$392.84	\$409.79	\$426.75 See Web
<b>PE-P300LL-27478 Coax, 50 Ohm</b>						
<b>PE3M0186</b>	0.160" dia.				dB/100ft	W
1 piece price shown. See web or call for volume pricing.	8"	12"	18"	24"	30"	36" Custom Len.
	\$340.63	\$345.53	\$352.89	\$360.23	\$367.59	\$374.93 See Web
<b>LMR-240-UF Coax, 50 Ohm</b>						
<b>PE3M0229</b>	0.300" dia.				dB/100ft	W
1 piece price shown. See web or call for volume pricing.	12"	18"	24"	36"	48"	60" Custom Len.
	\$405.42	\$419.57	\$433.72	\$462.02	\$490.32	\$518.63 See Web
<b>Standard Formable Cable Assemblies</b>						
<b>PE-SR401FL Coax, 50 Ohm</b>						
<b>PE34263</b>	" dia.				8 dB/100ft	1400 W
1 piece price shown. See web or call for volume pricing.	6"	12"	18"	24"	36"	48" Custom Len.
	\$131.41	\$139.34	\$139.15	\$146.85	\$172.01	\$177.66 See Web
<b>PE-SR402FL Coax, 50 Ohm</b>						
<b>PE3448</b>	" dia.				12 dB/100ft	450 W
1 piece price shown. See web or call for volume pricing.	6"	12"	18"	24"	36"	48" Custom Len.
	\$69.22	\$73.14	\$77.18	\$81.22	\$84.08	\$91.61 See Web
<b>PE-SR405FL Coax, 50 Ohm</b>						
<b>PE3657</b>	" dia.				23 dB/100ft	130 W
1 piece price shown. See web or call for volume pricing.	6"	12"	18"	24"	36"	48" Custom Len.
	\$81.73	\$82.30	\$87.64	\$92.98	\$103.68	\$114.37 See Web
<b>Standard Flexible Cable Assemblies</b>						
<b>RG8A/U Coax, 50 Ohm</b>						
<b>PE3323</b>	0.405" dia.				8 dB/100ft	190 W
1 piece price shown. See web or call for volume pricing.	12"	24"	36"	48"	60"	72" Custom Len.
	\$131.53	\$126.91	\$137.67	\$132.58	\$135.41	\$138.24 See Web
<b>RG142B/U Coax, 50 Ohm</b>						

Part No.	Cable Dia.				Attn. @ 1 GHz	Power @ 1 GHz
<b>PE3568</b>	0.195" dia.				13 dB/100ft	650 W
1 piece price shown. See web or call for volume pricing.	12"	24"	36"	48"	60"	72" Custom Len.
	\$48.86	\$54.94	\$61.02	\$67.45	\$73.65	\$79.85 See Web
<b>RG174A/U Coax, 50 Ohm</b>						
<b>PE3291</b>	0.110" dia.				32 dB/100ft	17 W
1 piece price shown. See web or call for volume pricing.	12"	24"	36"	48"	60"	72" Custom Len.
	\$50.00	\$50.58	\$48.94	\$51.76	\$52.36	\$52.95 See Web
<b>RG178B/U Coax, 50 Ohm</b>						
<b>PE3321</b>	0.072" dia.				44 dB/100ft	55 W
1 piece price shown. See web or call for volume pricing.	12"	24"	36"	48"	60"	72" Custom Len.
	\$71.84	\$72.90	\$73.96	\$70.66	\$71.61	\$77.24 See Web
<b>RG188A/U Coax, 50 Ohm</b>						
<b>PE3911</b>	0.110" dia.				32 dB/100ft	160 W
1 piece price shown. See web or call for volume pricing.	12"	24"	36"	48"	60"	72" Custom Len.
	\$50.78	\$57.33	\$55.22	\$57.44	\$59.66	\$61.88 See Web
<b>RG214/U Coax, 50 Ohm</b>						
<b>PE3422</b>	0.425" dia.				7 dB/100ft	190 W
1 piece price shown. See web or call for volume pricing.	12"	24"	36"	48"	60"	72" Custom Len.
	\$130.37	\$137.71	\$145.03	\$152.36	\$159.68	\$177.86 See Web
<b>RG223/U Coax, 50 Ohm</b>						
<b>PE3519</b>	0.210" dia.				13 dB/100ft	53 W
1 piece price shown. See web or call for volume pricing.	12"	24"	36"	48"	60"	72" Custom Len.
	\$44.65	\$47.76	\$50.88	\$54.17	\$57.34	\$60.52 See Web
<b>RG316-DS Coax, 50 Ohm</b>						
<b>PE3957</b>	0.114" dia.				9 dB/100ft	85 W
1 piece price shown. See web or call for volume pricing.	12"	24"	36"	48"	60"	72" Custom Len.
	\$42.70	\$45.51	\$48.42	\$51.34	\$55.45	\$58.64 See Web
<b>RG393/U Coax, 50 Ohm</b>						
<b>PE3302</b>	0.390" dia.				8 dB/100ft	1700 W
1 piece price shown. See web or call for volume pricing.	12"	24"	36"	48"	60"	72" Custom Len.
	\$139.09	\$154.55	\$170.02	\$197.61	\$214.34	\$231.05 See Web
<b>RG400/U Coax, 50 Ohm</b>						
<b>PE3614</b>	0.195" dia.				15 dB/100ft	650 W
1 piece price shown. See web or call for volume pricing.	12"	24"	36"	48"	60"	72" Custom Len.
	\$58.24	\$65.63	\$73.03	\$80.85	\$88.40	\$95.93 See Web
<b>PE-P141 Coax, 50 Ohm</b>						
<b>PE304</b>	0.163" dia.				dB/100ft	W
1 piece price shown. See web or call for volume pricing.	12"	24"	36"	48"	60"	72" Custom Len.
	\$154.90	\$170.91	\$182.26	\$198.26	\$205.85	\$217.43 See Web
<b>PE-P195 Coax, 50 Ohm</b>						
<b>PE3318</b>	0.195" dia.				13 dB/100ft	650 W
1 piece price shown. See web or call for volume pricing.	12"	24"	36"	48"	60"	72" Custom Len.
	\$56.21	\$68.03	\$77.61	\$87.75	\$97.51	\$100.47 See Web
<b>LMR-240-DB Coax, 50 Ohm</b>						
<b>PE3C3354</b>	0.240" dia.				8 dB/100ft	W
1 piece price shown. See web or call for volume pricing.	12"	24"	36"	48"	60"	39.37" Custom Len.
	\$38.40	\$39.51	\$40.62	\$41.74	\$42.85	Call See Web
<b>Standard Semi-Rigid Cable Assemblies</b>						
<b>PE-047SR Coax, 50 Ohm</b>						
<b>PE34257</b>	" dia.				40 dB/100ft	32 W
1 piece price shown. See web or call for volume pricing.	6"	12"	18"	24"	36"	48" Custom Len.
	\$85.54	\$90.52	\$95.52	\$100.43	\$118.08	\$120.30 See Web
<b>PE-SR402AL Coax, 50 Ohm</b>						
<b>PE34265</b>	0.141" dia.				13 dB/100ft	450 W
1 piece price shown. See web or call for volume pricing.	6"	12"	18"	24"	36"	48" Custom Len.
	\$69.62	\$73.80	\$78.89	\$79.04	\$88.45	\$97.85 See Web
<b>PE-SR405AL Coax, 50 Ohm</b>						
<b>PE34270</b>	" dia.				23 dB/100ft	130 W
1 piece price shown. See web or call for volume pricing.	6"	12"	18"	24"	36"	48" Custom Len.
	\$80.20	\$80.20	\$84.51	\$88.83	\$97.48	\$106.11 See Web
<b>RG401/U Coax, 50 Ohm</b>						
<b>PE33001</b>	" dia.				8 dB/100ft	1400 W
1 piece price shown. See web or call for volume pricing.	6"	12"	18"	24"	36"	48" Custom Len.
	\$135.42	\$138.14	\$149.11	\$160.09	\$182.03	\$203.98 See Web
<b>RG405/U Coax, 50 Ohm</b>						
<b>PE3828</b>	" dia.				22 dB/100ft	130 W
1 piece price shown. See web or call for volume pricing.	6"	12"	18"	24"	36"	48" Custom Len.
	\$79.43	\$83.04	\$81.78	\$85.22	\$97.89	\$98.95 See Web

Cable Assemblies

See Our Website For Current Pricing & Real-Time Stock Availability!

For Custom Lengths, Metric Lengths or Special Configurations, Please call (949) 261-1920



Technical Support  
+1 (949) 261-1920



Same-Day Shipping,  
Even Custom Cable Assemblies

For our complete selection of cable assemblies, please visit our website

Cable Assemblies

See Our Website For Current Pricing & Real-Time Stock Availability!

PE-SR401AL-STRAIGHT Coax, 50 Ohm				
Part No. <a href="#">PE34259</a>	Cable Dia.	Attn. @ 1 GHz	Power @ 1 GHz	
1 piece price shown. See web or call for volume pricing.				
6"	12"	18"	24"	36"
\$117.83	\$134.26	\$146.06	\$157.87	\$161.82
88				
Standard Flexible Cable Assemblies				
RG55B/U Coax, 53 Ohm				
Part No. <a href="#">PE3654</a>	Cable Dia.	Attn. @ 1 GHz	Power @ 1 GHz	
1 piece price shown. See web or call for volume pricing.				
12"	24"	36"	48"	60"
\$44.23	\$46.47	\$52.06	\$50.95	\$53.20
89				
SMA MALE TO N MALE RIGHT ANGLE				
Low Loss Flexible Cable Assemblies				
PE-P142LL Coax, 50 Ohm				
Part No. <a href="#">PE3C1037</a>	Cable Dia.	Attn. @ 1 GHz	Power @ 1 GHz	
1 piece price shown. See web or call for volume pricing.				
12"	24"	36"	48"	60"
\$225.01	\$241.25	\$257.47	\$273.71	\$289.95
90				
PE-P142LL-27478 Coax, 50 Ohm				
Part No. <a href="#">PE3M0134</a>	Cable Dia.	Attn. @ 1 GHz	Power @ 1 GHz	
1 piece price shown. See web or call for volume pricing.				
12"	18"	24"	36"	48"
\$473.95	\$482.43	\$490.91	\$507.86	\$524.82
91				
PE-P160LL-27478 Coax, 50 Ohm				
Part No. <a href="#">PE3M0188</a>	Cable Dia.	Attn. @ 1 GHz	Power @ 1 GHz	
1 piece price shown. See web or call for volume pricing.				
8"	12"	18"	24"	30"
\$438.69	\$443.59	\$450.94	\$458.29	\$465.64
92				
PE-P300LL-27478 Coax, 50 Ohm				
Part No. <a href="#">PE3M0231</a>	Cable Dia.	Attn. @ 1 GHz	Power @ 1 GHz	
1 piece price shown. See web or call for volume pricing.				
12"	18"	24"	36"	48"
\$550.36	\$564.51	\$578.66	\$606.96	\$635.27
93				
Low Loss Test Flexible Cable Assemblies				
PE-P300LL Coax, 50 Ohm				
Part No. <a href="#">PE3C3236</a>	Cable Dia.	Attn. @ 1 GHz	Power @ 1 GHz	
1 piece price shown. See web or call for volume pricing.				
12"	24"	36"	48"	60"
\$233.15	\$258.34	\$283.51	\$308.70	\$333.88
94				
Standard Formable Cable Assemblies				
PE-SR402FL Coax, 50 Ohm				
Part No. <a href="#">PE3W00507</a>	Cable Dia.	Attn. @ 1 GHz	Power @ 1 GHz	
1 piece price shown. See web or call for volume pricing.				
12"	24"	36"	48"	60"
\$60.94	\$68.78	\$76.63	\$84.47	\$92.32
95				
PE-SR402FLJ Coax, 50 Ohm				
Part No. <a href="#">PE3W00504</a>	Cable Dia.	Attn. @ 1 GHz	Power @ 1 GHz	
1 piece price shown. See web or call for volume pricing.				
12"	24"	36"	48"	60"
\$60.16	\$68.23	\$76.30	\$84.38	\$92.45
96				
Standard Flexible Cable Assemblies				
RG58C/U Coax, 50 Ohm				
Part No. <a href="#">PE3076</a>	Cable Dia.	Attn. @ 1 GHz	Power @ 1 GHz	
1 piece price shown. See web or call for volume pricing.				
12"	24"	36"	48"	60"
\$62.28	\$63.10	\$63.91	\$64.77	\$65.60
97				
SMA MALE TO N FEMALE				
Low Loss Test Flexible Cable Assemblies				
PE-P300LL Coax, 50 Ohm				
Part No. <a href="#">PE3C3237</a>	Cable Dia.	Attn. @ 1 GHz	Power @ 1 GHz	
1 piece price shown. See web or call for volume pricing.				
12"	24"	36"	48"	60"
\$217.87	\$243.04	\$268.23	\$293.41	\$318.59
98				
PE-P300LL Coax, 50 Ohm				
Part No. <a href="#">PE3C3252</a>	Cable Dia.	Attn. @ 1 GHz	Power @ 1 GHz	
1 piece price shown. See web or call for volume pricing.				
12"	24"	36"	48"	60"
\$236.31	\$261.52	\$286.72	\$311.93	\$337.12
99				
SMA MALE TO N FEMALE BULKHEAD				
SEE MOUNTING HOLE SECTION ON PAGE 369				
Precision Formable Cable Assemblies				
PE-SR402FL Coax, 50 Ohm				

Part No. <a href="#">PE39455</a>					Cable Dia.	Attn. @ 1 GHz	Power @ 1 GHz
1 piece price shown. See web or call for volume pricing.					* dia.	12 dB/100ft	450 W
6"	9"	12"	18"	24"	-	-	Custom Len.
\$65.56	\$59.60	\$65.56	\$69.74	\$73.91	-	-	See Web
1							
PE-SR402FLJ Coax, 50 Ohm							
Part No. <a href="#">PE39469</a>					Cable Dia.	Attn. @ 1 GHz	Power @ 1 GHz
1 piece price shown. See web or call for volume pricing.					0.161" dia.	12 dB/100ft	450 W
6"	9"	12"	18"	24"	-	-	Custom Len.
\$53.80	\$49.81	\$53.80	\$58.29	\$62.78	-	-	See Web
2							
PE-SR405FL Coax, 50 Ohm							
Part No. <a href="#">PE39447</a>					Cable Dia.	Attn. @ 1 GHz	Power @ 1 GHz
1 piece price shown. See web or call for volume pricing.					* dia.	23 dB/100ft	130 W
6"	9"	12"	18"	24"	-	-	Custom Len.
\$26.56	\$46.07	\$26.56	\$32.20	\$37.84	-	-	See Web
3							
PE-SR405FLJ Coax, 50 Ohm							
Part No. <a href="#">PE39461</a>					Cable Dia.	Attn. @ 1 GHz	Power @ 1 GHz
1 piece price shown. See web or call for volume pricing.					0.098" dia.	20 dB/100ft	130 W
6"	9"	12"	18"	24"	-	-	Custom Len.
\$51.44	\$51.44	\$51.44	\$55.62	\$59.79	-	-	See Web
4							
Low Loss Flexible Cable Assemblies							
PE-P142LL Coax, 50 Ohm							
Part No. <a href="#">PE3C2162</a>					Cable Dia.	Attn. @ 1 GHz	Power @ 1 GHz
1 piece price shown. See web or call for volume pricing.					0.195" dia.	10 dB/100ft	W
12"	24"	36"	48"	60"	60"	50CM	Custom Len.
\$179.72	\$195.96	\$212.18	\$228.42	\$244.66	\$190.12	-	See Web
5							
PE-P142LL-27478 Coax, 50 Ohm							
Part No. <a href="#">PE3M0133</a>					Cable Dia.	Attn. @ 1 GHz	Power @ 1 GHz
1 piece price shown. See web or call for volume pricing.					0.195" dia.	dB/100ft	W
12"	18"	24"	36"	48"	60"	60"	Custom Len.
\$446.13	\$454.60	\$463.08	\$480.04	\$497.00	\$513.95	-	See Web
6							
PE-P160LL-27478 Coax, 50 Ohm							
Part No. <a href="#">PE3M0187</a>					Cable Dia.	Attn. @ 1 GHz	Power @ 1 GHz
1 piece price shown. See web or call for volume pricing.					0.160" dia.	dB/100ft	W
8"	12"	18"	24"	30"	36"	36"	Custom Len.
\$442.62	\$447.52	\$454.87	\$462.22	\$469.58	\$476.92	-	See Web
7							
PE-P300LL-27478 Coax, 50 Ohm							
Part No. <a href="#">PE3M0230</a>					Cable Dia.	Attn. @ 1 GHz	Power @ 1 GHz
1 piece price shown. See web or call for volume pricing.					0.300" dia.	dB/100ft	W
12"	18"	24"	36"	48"	60"	60"	Custom Len.
\$481.10	\$495.25	\$509.40	\$537.70	\$566.01	\$594.31	-	See Web
8							
Low Loss Test Flexible Cable Assemblies							
PE-P300LL Coax, 50 Ohm							
Part No. <a href="#">PE3C3246</a>					Cable Dia.	Attn. @ 1 GHz	Power @ 1 GHz
1 piece price shown. See web or call for volume pricing.					0.300" dia.	dB/100ft	W
12"	24"	36"	48"	60"	50CM	50CM	Custom Len.
\$294.09	\$319.30	\$344.50	\$369.71	\$394.90	\$310.24	-	See Web
9							
Standard Formable Cable Assemblies							
PE-SR402FL Coax, 50 Ohm							
Part No. <a href="#">PE33996</a>					Cable Dia.	Attn. @ 1 GHz	Power @ 1 GHz
1 piece price shown. See web or call for volume pricing.					* dia.	12 dB/100ft	450 W
6"	12"	18"	24"	36"	48"	48"	Custom Len.
\$80.15	\$80.15	\$84.33	\$88.50	\$96.86	\$105.21	-	See Web
10							
PE-SR405FL Coax, 50 Ohm							
Part No. <a href="#">PE33844</a>					Cable Dia.	Attn. @ 1 GHz	Power @ 1 GHz
1 piece price shown. See web or call for volume pricing.					* dia.	23 dB/100ft	130 W
6"	12"	18"	24"	36"	48"	48"	Custom Len.
\$81.30	\$81.89	\$87.24	\$92.60	\$103.28	\$113.98	-	See Web
11							
Standard Flexible Cable Assemblies							
RG58C/U Coax, 50 Ohm							
Part No. <a href="#">PE3013</a>					Cable Dia.	Attn. @ 1 GHz	Power @ 1 GHz
1 piece price shown. See web or call for volume pricing.					0.195" dia.	20 dB/100ft	44 W
6"	12"	18"	24"	36"	48"	48"	Custom Len.
\$57.55	\$59.86	\$57.91	\$60.67	\$61.48	\$62.34	-	See Web
12							
RG142B/U Coax, 50 Ohm							
Part No. <a href="#">PE3345</a>					Cable Dia.	Attn. @ 1 GHz	Power @ 1 GHz
1 piece price shown. See web or call for volume pricing.					0.195" dia.	13 dB/100ft	650 W
6"	12"	18"	24"	36"	48"	48"	Custom Len.
\$51.50	\$51.37	\$57.49	\$60.53	\$66.61	\$73.04	-	See Web
13							
RG174A/U Coax, 50 Ohm							
Part No. <a href="#">PE34171</a>					Cable Dia.	Attn. @ 1 GHz	Power @ 1 GHz
1 piece price shown. See web or call for volume pricing.					0.100" dia.	32 dB/100ft	16 W
6"	12"	18"	24"	36"	48"	48"	Custom Len.
\$64.99	\$65.27	\$60.66	\$60.88	\$61.30	\$61.74	-	See Web
14							
RG178B/U Coax, 50 Ohm							
Part No. <a href="#">PE34174</a>					Cable Dia.	Attn. @ 1 GHz	Power @ 1 GHz
1 piece price shown. See web or call for volume pricing.					0.072" dia.	44 dB/100ft	78 W
6"	12"	18"	24"	36"	48"	48"	Custom Len.
\$63.83	\$64.29	\$64.78	\$65.27	\$66.22	\$67.17	-	See Web
15							
RG188A/U Coax, 50 Ohm							
Part No. <a href="#">PE34176</a>					Cable Dia.	Attn. @ 1 GHz	Power @ 1 GHz
1 piece price shown. See web or call for volume pricing.					0.110" dia.	26 dB/100ft	160 W
6"	12"	18"	24"	36"	48"	48"	Custom Len.
\$56.63	\$57.71	\$58.71	\$59.79	\$61.96	\$64.06	-	See Web
16							

\*Coax Performance at 1 GHz Notes: Cable assembly max frequency may be lower than connector or coax max frequency

# For our complete selection of cable assemblies, please visit our website

RG214/U Coax, 50 Ohm				
Part No. <b>PE33481</b>	Cable Dia.	Attn. @ 1 GHz	Power @ 1 GHz	
1 piece price shown. See web or call for volume pricing.				
6"	12"	18"	24"	36"
\$126.56	\$126.56	\$138.04	\$133.90	\$141.22
				48"
				Custom Len.
				See Web
RG223/U Coax, 50 Ohm				
Part No. <b>PE3193</b>	Cable Dia.	Attn. @ 1 GHz	Power @ 1 GHz	
1 piece price shown. See web or call for volume pricing.				
6"	12"	18"	24"	36"
\$51.92	\$53.44	\$50.93	\$52.39	\$55.29
				48"
				Custom Len.
				See Web
RG316/U Coax, 50 Ohm				
Part No. <b>PE33555</b>	Cable Dia.	Attn. @ 1 GHz	Power @ 1 GHz	
1 piece price shown. See web or call for volume pricing.				
6"	12"	18"	24"	36"
\$65.50	\$67.02	\$63.49	\$64.94	\$73.26
				48"
				Custom Len.
				See Web
RG316-DS Coax, 50 Ohm				
Part No. <b>PE33929</b>	Cable Dia.	Attn. @ 1 GHz	Power @ 1 GHz	
1 piece price shown. See web or call for volume pricing.				
6"	12"	18"	24"	36"
\$59.87	\$64.66	\$61.32	\$67.78	\$70.90
				48"
				Custom Len.
				See Web
RG400/U Coax, 50 Ohm				
Part No. <b>PE33117</b>	Cable Dia.	Attn. @ 1 GHz	Power @ 1 GHz	
1 piece price shown. See web or call for volume pricing.				
6"	12"	18"	24"	36"
\$59.24	\$62.80	\$62.73	\$70.19	\$77.59
				48"
				Custom Len.
				See Web
PE-P195 Coax, 50 Ohm				
Part No. <b>PE34178</b>	Cable Dia.	Attn. @ 1 GHz	Power @ 1 GHz	
1 piece price shown. See web or call for volume pricing.				
6"	12"	18"	24"	36"
\$63.14	\$67.78	\$67.18	\$71.61	\$80.47
				48"
				Custom Len.
				See Web
Standard Semi-Rigid Cable Assemblies				
PE-SR402AL Coax, 50 Ohm				
Part No. <b>PE34143</b>	Cable Dia.	Attn. @ 1 GHz	Power @ 1 GHz	
1 piece price shown. See web or call for volume pricing.				
6"	12"	18"	24"	36"
\$78.85	\$83.78	\$88.88	\$93.97	\$97.86
				48"
				Custom Len.
				See Web
PE-SR405AL Coax, 50 Ohm				
Part No. <b>PE34155</b>	Cable Dia.	Attn. @ 1 GHz	Power @ 1 GHz	
1 piece price shown. See web or call for volume pricing.				
6"	12"	18"	24"	36"
\$78.22	\$78.22	\$82.55	\$86.86	\$105.06
				48"
				Custom Len.
				See Web
RG401/U Coax, 50 Ohm				
Part No. <b>PE34157</b>	Cable Dia.	Attn. @ 1 GHz	Power @ 1 GHz	
1 piece price shown. See web or call for volume pricing.				
6"	12"	18"	24"	36"
\$121.02	\$121.02	\$132.00	\$142.97	\$164.91
				48"
				Custom Len.
				See Web
RG402/U Coax, 50 Ohm				
Part No. <b>PE3769</b>	Cable Dia.	Attn. @ 1 GHz	Power @ 1 GHz	
1 piece price shown. See web or call for volume pricing.				
6"	12"	18"	24"	36"
\$76.88	\$81.49	\$80.53	\$84.18	\$91.48
				48"
				Custom Len.
				See Web
RG405/U Coax, 50 Ohm				
Part No. <b>PE3367</b>	Cable Dia.	Attn. @ 1 GHz	Power @ 1 GHz	
1 piece price shown. See web or call for volume pricing.				
6"	12"	18"	24"	36"
\$68.74	\$72.10	\$75.40	\$78.70	\$85.36
				48"
				Custom Len.
				See Web
Standard Flexible Cable Assemblies				
RG55B/U Coax, 53 Ohm				
Part No. <b>PE34169</b>	Cable Dia.	Attn. @ 1 GHz	Power @ 1 GHz	
1 piece price shown. See web or call for volume pricing.				
6"	12"	18"	24"	36"
\$48.65	\$48.65	\$49.78	\$50.89	\$53.13
				48"
				Custom Len.
				See Web
SMA MALE TO QMA MALE				
Low Loss Flexible Cable Assemblies				
PE-C195 Coax, 50 Ohm				
Part No. <b>PE38116</b>	Cable Dia.	Attn. @ 1 GHz	Power @ 1 GHz	
1 piece price shown. See web or call for volume pricing.				
12"	24"	36"	48"	60"
\$44.69	\$49.04	\$46.11	\$46.83	\$47.54
				72"
				Custom Len.
				See Web
Standard Flexible Cable Assemblies				
RG58C/U Coax, 50 Ohm				
Part No. <b>PE38275</b>	Cable Dia.	Attn. @ 1 GHz	Power @ 1 GHz	
1 piece price shown. See web or call for volume pricing.				
12"	24"	36"	48"	60"
\$54.25	\$50.96	\$51.70	\$52.44	\$53.18
				72"
				Custom Len.
				See Web
RG316/U Coax, 50 Ohm				
Part No. <b>PE38273</b>	Cable Dia.	Attn. @ 1 GHz	Power @ 1 GHz	
1 piece price shown. See web or call for volume pricing.				
12"	24"	36"	48"	60"
\$53.72	\$56.60	\$59.49	\$66.50	\$65.27
				72"
				Custom Len.
				See Web

RG316-DS Coax, 50 Ohm				
Part No. <b>PE38274</b>	Cable Dia.	Attn. @ 1 GHz	Power @ 1 GHz	
1 piece price shown. See web or call for volume pricing.				
12"	24"	36"	48"	60"
\$72.18	\$71.01	\$73.91	\$76.83	\$79.74
				72"
				Custom Len.
				See Web
SMA MALE TO SMA MALE				
Flexible Cable Assemblies				
LMR-100A-PVC Coax, 50 Ohm				
Part No. <b>PE3C0113</b>	Cable Dia.	Attn. @ 1 GHz	Power @ 1 GHz	
1 piece price shown. See web or call for volume pricing.				
12"	24"	36"	48"	60"
\$43.92	\$44.68	\$45.44	\$46.24	\$47.01
				72"
				Custom Len.
				See Web
LMR-195 Coax, 50 Ohm				
Part No. <b>PE3C0038</b>	Cable Dia.	Attn. @ 1 GHz	Power @ 1 GHz	
1 piece price shown. See web or call for volume pricing.				
12"	24"	36"	48"	60"
\$36.04	\$36.80	\$37.55	\$38.34	\$39.10
				72"
				Custom Len.
				See Web
PE-P160LL Coax, 50 Ohm				
Part No. <b>PE3C5241</b>	Cable Dia.	Attn. @ 1 GHz	Power @ 1 GHz	
1 piece price shown. See web or call for volume pricing.				
12"	24"	36"	48"	60"
\$205.44	\$226.16	\$246.87	\$267.58	\$288.29
				72"
				Custom Len.
				See Web
Semi-Rigid Cable Assemblies				
PE-SR402AL Coax, 50 Ohm				
Part No. <b>PE3C1398</b>	Cable Dia.	Attn. @ 1 GHz	Power @ 1 GHz	
1 piece price shown. See web or call for volume pricing.				
12"	24"	36"	48"	60"
\$48.78	\$58.81	\$63.83	\$73.86	\$83.89
				72"
				Custom Len.
				See Web
Precision Formable Cable Assemblies				
PE-80TEST Coax, 50 Ohm				
Part No. <b>PE3TC0101</b>	Cable Dia.	Attn. @ 1 GHz	Power @ 1 GHz	
1 piece price shown. See web or call for volume pricing.				
24"	48"	72"	-	-
\$313.54	\$399.28	\$485.03	-	-
				Custom Len.
				See Web
PE-90TEST Coax, 50 Ohm				
Part No. <b>PE3TC0201</b>	Cable Dia.	Attn. @ 1 GHz	Power @ 1 GHz	
1 piece price shown. See web or call for volume pricing.				
24"	48"	72"	-	-
\$454.28	\$540.02	\$625.77	-	-
				Custom Len.
				See Web
PE-90TEST Coax, 50 Ohm				
Part No. <b>PE3TC0301</b>	Cable Dia.	Attn. @ 1 GHz	Power @ 1 GHz	
1 piece price shown. See web or call for volume pricing.				
24"	48"	72"	-	-
\$230.61	\$328.04	\$405.99	-	-
				Custom Len.
				See Web
PE-90TEST Coax, 50 Ohm				
Part No. <b>PE3TC0401</b>	Cable Dia.	Attn. @ 1 GHz	Power @ 1 GHz	
1 piece price shown. See web or call for volume pricing.				
24"	48"	72"	-	-
\$390.84	\$468.79	\$546.73	-	-
				Custom Len.
				See Web
Precision Flexible Cable Assemblies				
PE-P141 Coax, 50 Ohm				
Part No. <b>PE3CA1130</b>	Cable Dia.	Attn. @ 1 GHz	Power @ 1 GHz	
1 piece price shown. See web or call for volume pricing.				
12"	24"	36"	48"	60"
\$122.88	\$133.28	\$143.67	\$154.06	\$164.45
				72"
				Custom Len.
				See Web
PE-P141 Coax, 50 Ohm				
Part No. <b>PE312</b>	Cable Dia.	Attn. @ 1 GHz	Power @ 1 GHz	
1 piece price shown. See web or call for volume pricing.				
12"	24"	36"	48"	60"
\$158.15	\$163.79	\$162.56	\$147.71	\$175.78
				72"
				Custom Len.
				See Web
Low Loss Flexible Cable Assemblies				
PE-C100-LSZH Coax, 50 Ohm				
Part No. <b>PE37908</b>	Cable Dia.	Attn. @ 1 GHz	Power @ 1 GHz	
1 piece price shown. See web or call for volume pricing.				
12"	24"	36"	48"	60"
\$48.61	\$49.93	\$51.26	\$52.67	\$54.02
				72"
				Custom Len.
				See Web
PE-C195 Coax, 50 Ohm				
Part No. <b>PE35784</b>	Cable Dia.	Attn. @ 1 GHz	Power @ 1 GHz	
1 piece price shown. See web or call for volume pricing.				
12"	24"	36"	48"	60"
\$39.53	\$40.32	\$41.10	\$41.92	\$42.72
				72"
				Custom Len.
				See Web
PE-C240 Coax, 50 Ohm				
Part No. <b>PE38628</b>	Cable Dia.	Attn. @ 1 GHz	Power @ 1 GHz	
1 piece price shown. See web or call for volume pricing.				
12"	24"	36"	48"	60"
\$51.03	\$55.22	\$54.70	\$57.46	\$60.27
				72"
				Custom Len.
				See Web
LMR-100A-PVC Coax, 50 Ohm				
Part No. <b>PE3C0057</b>	Cable Dia.	Attn. @ 1 GHz	Power @ 1 GHz	
1 piece price shown. See web or call for volume pricing.				
12"	24"	36"	48"	60"
\$47.50	\$48.26	\$49.02	\$49.82	\$50.60
				72"
				Custom Len.
				See Web
LMR-240 Coax, 50 Ohm				

Continued on Next Page

For Custom Lengths, Metric Lengths or Special Configurations, Please call (949) 261-1920



Technical Support  
+1 (949) 261-1920



Same-Day Shipping,  
Even Custom Cable Assemblies

Cable Assemblies

See Our Website For Current Pricing & Real-Time Stock Availability!

For our complete selection of cable assemblies, please visit our website

Cable Assemblies  
See Our Website For Current Pricing & Real-Time Stock Availability!

Part No. <a href="#">PE3C0052</a>				Cable Dia.	Attn. @ 1 GHz	Power @ 1 GHz	47
1 piece price shown. See web or call for volume pricing.				0.240" dia.	8 dB/100ft	W	
12"	24"	36"	48"	60"	-	Custom Len.	
\$50.55	\$51.51	\$52.49	\$53.52	\$54.52	-	See Web	
Part No. <a href="#">PE3C0103</a>				Cable Dia.	Attn. @ 1 GHz	Power @ 1 GHz	48
1 piece price shown. See web or call for volume pricing.				0.240" dia.	8 dB/100ft	W	
12"	24"	36"	48"	60"	-	Custom Len.	
\$38.19	\$39.17	\$40.15	\$41.18	\$42.16	-	See Web	
<b>LMR-400-DB Coax, 50 Ohm</b>							
Part No. <a href="#">PE3W01582</a>				Cable Dia.	Attn. @ 1 GHz	Power @ 1 GHz	49
1 piece price shown. See web or call for volume pricing.				0.405" dia.	4 dB/100ft	W	
12"	24"	36"	48"	60"	50CM	Custom Len.	
\$70.87	\$72.30	\$73.75	\$75.18	\$76.63	\$71.79	See Web	
<b>PE-P142LL Coax, 50 Ohm</b>							
Part No. <a href="#">PE3C0230</a>				Cable Dia.	Attn. @ 1 GHz	Power @ 1 GHz	50
1 piece price shown. See web or call for volume pricing.				0.320" dia.	7 dB/100ft	W	
12"	24"	36"	48"	60"	72"	Custom Len.	
\$264.59	\$282.95	\$352.36	\$357.63	\$379.43	\$418.18	See Web	
<b>PE-P142LL-27478 Coax, 50 Ohm</b>							
Part No. <a href="#">PE3M0125</a>				Cable Dia.	Attn. @ 1 GHz	Power @ 1 GHz	51
1 piece price shown. See web or call for volume pricing.				0.195" dia.	dB/100ft	W	
12"	18"	24"	36"	48"	60"	Custom Len.	
\$347.79	\$356.27	\$364.75	\$381.71	\$398.66	\$415.62	See Web	
<b>PE-P160LL-27478 Coax, 50 Ohm</b>							
Part No. <a href="#">PE3M0180</a>				Cable Dia.	Attn. @ 1 GHz	Power @ 1 GHz	52
1 piece price shown. See web or call for volume pricing.				0.160" dia.	dB/100ft	W	
8"	12"	18"	24"	30"	36"	Custom Len.	
\$340.63	\$345.53	\$352.89	\$360.23	\$367.59	\$374.93	See Web	
<b>PE-P300LL-27478 Coax, 50 Ohm</b>							
Part No. <a href="#">PE3M0225</a>				Cable Dia.	Attn. @ 1 GHz	Power @ 1 GHz	53
1 piece price shown. See web or call for volume pricing.				0.300" dia.	dB/100ft	W	
12"	18"	24"	36"	48"	60"	Custom Len.	
\$392.78	\$406.93	\$421.09	\$449.39	\$477.69	\$505.99	See Web	
<b>LMR-240-DB Coax, 50 Ohm</b>							
Part No. <a href="#">PE3W03353</a>				Cable Dia.	Attn. @ 1 GHz	Power @ 1 GHz	54
1 piece price shown. See web or call for volume pricing.				0.240" dia.	8 dB/100ft	W	
12"	24"	36"	48"	50CM	Custom Len.		
\$51.53	\$52.65	\$53.75	\$54.85	\$55.96	\$52.24	See Web	
<b>Low PIM Formable Cable Assemblies</b>							
<b>PE-SR402FLJ Low PIM Coax, 50 Ohm</b>							
Part No. <a href="#">PE3C2008</a>				Cable Dia.	Attn. @ 1 GHz	Power @ 1 GHz	55
1 piece price shown. See web or call for volume pricing.				0.161" dia.	dB/100ft	W	
100CM	200CM	-	-	-	-	Custom Len.	
\$71.50	\$86.03	-	-	-	-	See Web	
<b>Low PIM Corrugated Cable Assemblies</b>							
<b>SPP-250-LLPL Coax, 50 Ohm</b>							
Part No. <a href="#">PE3C6207</a>				Cable Dia.	Attn. @ 1 GHz	Power @ 1 GHz	56
1 piece price shown. See web or call for volume pricing.				0.280" dia.	6 dB/100ft	650 W	
12"	24"	36"	48"	60"	50CM	Custom Len.	
\$42.83	\$48.41	\$53.99	\$59.57	\$65.15	\$46.39	See Web	
Part No. <a href="#">PE3C5888</a>				Cable Dia.	Attn. @ 1 GHz	Power @ 1 GHz	57
1 piece price shown. See web or call for volume pricing.				0.280" dia.	6 dB/100ft	650 W	
12"	24"	36"	48"	50CM	Custom Len.		
\$57.35	\$62.93	\$68.51	\$74.09	\$79.67	\$60.93	See Web	
<b>Test Flexible Cable Assemblies</b>							
<b>PE-P160 Coax, 50 Ohm</b>							
Part No. <a href="#">PE366</a>				Cable Dia.	Attn. @ 1 GHz	Power @ 1 GHz	58
1 piece price shown. See web or call for volume pricing.				0.160" dia.	13 dB/100ft	W	
36"	48"	100CM	150CM	-	-	Custom Len.	
\$325.89	\$351.04	\$332.96	\$374.21	-	-	See Web	
<b>Low Loss Test Flexible Cable Assemblies</b>							
<b>PE-P300LL Coax, 50 Ohm</b>							
Part No. <a href="#">PE3C3235</a>				Cable Dia.	Attn. @ 1 GHz	Power @ 1 GHz	59
1 piece price shown. See web or call for volume pricing.				0.300" dia.	6 dB/100ft	W	
12"	24"	36"	48"	60"	50CM	Custom Len.	
\$153.75	\$178.94	\$204.11	\$229.30	\$254.48	\$169.90	See Web	
Part No. <a href="#">PE333</a>				Cable Dia.	Attn. @ 1 GHz	Power @ 1 GHz	60
1 piece price shown. See web or call for volume pricing.				0.300" dia.	5 dB/100ft	W	
12"	24"	36"	48"	60"	50CM	Custom Len.	
\$244.02	\$269.96	\$295.90	\$321.84	\$347.78	\$260.65	See Web	
Part No. <a href="#">PE336</a>				Cable Dia.	Attn. @ 1 GHz	Power @ 1 GHz	61
1 piece price shown. See web or call for volume pricing.				0.300" dia.	dB/100ft	W	
12"	24"	36"	48"	60"	72"	Custom Len.	
\$235.75	\$261.69	\$287.63	\$318.95	\$339.50	\$376.99	See Web	
<b>PE-P142LL Coax, 50 Ohm</b>							
Part No. <a href="#">PE341</a>				Cable Dia.	Attn. @ 1 GHz	Power @ 1 GHz	62
1 piece price shown. See web or call for volume pricing.				0.195" dia.	7 dB/100ft	W	
12"	24"	36"	48"	60"	50CM	Custom Len.	
\$111.93	\$128.17	\$144.40	\$160.64	\$176.88	\$122.33	See Web	
<b>Standard Formable Cable Assemblies</b>							
<b>PE-SR047FL Coax, 50 Ohm</b>							

Part No. <a href="#">PE34186</a>				Cable Dia.	Attn. @ 1 GHz	Power @ 1 GHz	63
1 piece price shown. See web or call for volume pricing.				0.047" dia.	36 dB/100ft	32 W	
6"	12"	18"	24"	36"	48"	Custom Len.	
\$88.22	\$92.16	\$96.22	\$94.31	\$101.69	\$109.06	See Web	
<b>PE-SR401FL Coax, 50 Ohm</b>							
Part No. <a href="#">PE34188</a>				Cable Dia.	Attn. @ 1 GHz	Power @ 1 GHz	64
1 piece price shown. See web or call for volume pricing.				" dia.	7 dB/100ft	279 W	
6"	12"	18"	24"	36"	48"	Custom Len.	
\$121.29	\$129.22	\$137.39	\$145.55	\$177.48	\$192.89	See Web	
<b>PE-SR402FL Coax, 50 Ohm</b>							
Part No. <a href="#">PE39423</a>				Cable Dia.	Attn. @ 1 GHz	Power @ 1 GHz	65
1 piece price shown. See web or call for volume pricing.				" dia.	12 dB/100ft	400 W	
3"	6"	9"	12"	18"	24"	Custom Len.	
\$46.47	\$45.59	\$43.63	\$45.59	\$51.39	\$57.19	See Web	
Part No. <a href="#">PE3481</a>				Cable Dia.	Attn. @ 1 GHz	Power @ 1 GHz	66
1 piece price shown. See web or call for volume pricing.				" dia.	12 dB/100ft	400 W	
6"	12"	18"	24"	36"	48"	Custom Len.	
\$43.54	\$47.47	\$51.51	\$55.54	\$63.63	\$72.18	See Web	
<b>PE-SR402FLJ Coax, 50 Ohm</b>							
Part No. <a href="#">PE39437</a>				Cable Dia.	Attn. @ 1 GHz	Power @ 1 GHz	67
1 piece price shown. See web or call for volume pricing.				0.161" dia.	12 dB/100ft	303 W	
6"	9"	12"	18"	24"	-	Custom Len.	
\$57.75	\$55.73	\$57.75	\$62.24	\$66.72	-	See Web	
<b>PE-SR405FL Coax, 50 Ohm</b>							
Part No. <a href="#">PE39415</a>				Cable Dia.	Attn. @ 1 GHz	Power @ 1 GHz	68
1 piece price shown. See web or call for volume pricing.				" dia.	23 dB/100ft	105 W	
6"	9"	12"	18"	24"	-	Custom Len.	
\$50.03	\$48.15	\$50.03	\$55.61	\$61.19	-	See Web	
Part No. <a href="#">PE3867</a>				Cable Dia.	Attn. @ 1 GHz	Power @ 1 GHz	69
1 piece price shown. See web or call for volume pricing.				" dia.	23 dB/100ft	130 W	
6"	12"	18"	24"	36"	48"	Custom Len.	
\$50.50	\$56.00	\$61.68	\$67.35	\$74.22	\$84.92	See Web	
<b>PE-SR405FLJ Coax, 50 Ohm</b>							
Part No. <a href="#">PE39429</a>				Cable Dia.	Attn. @ 1 GHz	Power @ 1 GHz	70
1 piece price shown. See web or call for volume pricing.				0.105" dia.	20 dB/100ft	122 W	
6"	9"	12"	18"	24"	24"	Custom Len.	
\$49.99	\$47.91	\$49.99	\$54.47	\$58.96	-	See Web	
<b>Standard Flexible Cable Assemblies</b>							
<b>RG8X Coax, 50 Ohm</b>							
Part No. <a href="#">PE39087</a>				Cable Dia.	Attn. @ 1 GHz	Power @ 1 GHz	71
1 piece price shown. See web or call for volume pricing.				0.242" dia.	14 dB/100ft	60 W	
12"	24"	36"	48"	60"	-	Custom Len.	
\$63.72	\$66.78	\$74.61	\$78.34	\$81.95	-	See Web	
<b>RG58C/U Coax, 50 Ohm</b>							
Part No. <a href="#">PE3369</a>				Cable Dia.	Attn. @ 1 GHz	Power @ 1 GHz	72
1 piece price shown. See web or call for volume pricing.				0.195" dia.	20 dB/100ft	44 W	
6"	12"	18"	24"	36"	48"	Custom Len.	
\$43.02	\$43.02	\$43.40	\$43.76	\$44.50	\$45.24	See Web	
Part No. <a href="#">PE36689</a>				Cable Dia.	Attn. @ 1 GHz	Power @ 1 GHz	73
1 piece price shown. See web or call for volume pricing.				0.195" dia.	20 dB/100ft	44 W	
24"	36"	48"	-	-	-	Custom Len.	
\$112.67	\$106.95	\$114.34	-	-	-	See Web	
Part No. <a href="#">PE36690</a>				Cable Dia.	Attn. @ 1 GHz	Power @ 1 GHz	74
1 piece price shown. See web or call for volume pricing.				0.195" dia.	20 dB/100ft	80 W	
24"	36"	48"	72"	-	-	Custom Len.	
\$171.20	\$171.98	\$172.68	\$174.13	-	-	See Web	
<b>RG142B/U Coax, 50 Ohm</b>							
Part No. <a href="#">PE3385</a>				Cable Dia.	Attn. @ 1 GHz	Power @ 1 GHz	75
1 piece price shown. See web or call for volume pricing.				0.195" dia.	13 dB/100ft	600 W	
6"	12"	18"	24"	36"	48"	Custom Len.	
\$49.68	\$52.64	\$55.67	\$58.71	\$64.79	\$71.22	See Web	
<b>RG174A/U Coax, 50 Ohm</b>							
Part No. <a href="#">PE3353</a>				Cable Dia.	Attn. @ 1 GHz	Power @ 1 GHz	76
1 piece price shown. See web or call for volume pricing.				0.100" dia.	32 dB/100ft	16 W	
6"	12"	18"	24"	36"	48"	Custom Len.	
\$48.71	\$48.99	\$49.28	\$49.57	\$50.14	\$50.76	See Web	
Part No. <a href="#">PE3W00365</a>				Cable Dia.	Attn. @ 1 GHz	Power @ 1 GHz	77
1 piece price shown. See web or call for volume pricing.				0.110" dia.	32 dB/100ft	W	
12"	24"	36"	48"	60"	50CM	Custom Len.	
\$62.89	\$63.45	\$64.01	\$64.57	\$61.56	\$59.67	See Web	
<b>RG178B/U Coax, 50 Ohm</b>							
Part No. <a href="#">PE3574</a>				Cable Dia.	Attn. @ 1 GHz	Power @ 1 GHz	78
1 piece price shown. See web or call for volume pricing.				0.072" dia.	44 dB/100ft	78 W	
6"	12"	18"	24"	36"	48"	Custom Len.	
\$65.47	\$65.98	\$66.51	\$67.04	\$68.10	\$69.22	See Web	
<b>RG188A/U Coax, 50 Ohm</b>							
Part No. <a href="#">PE3361</a>				Cable Dia.	Attn. @ 1 GHz	Power @ 1 GHz	79
1 piece price shown. See web or call for volume pricing.				0.110" dia.	26 dB/100ft	160 W	
6"	12"	18"	24"	36"	48"	Custom Len.	
\$49.40	\$50.61	\$51.86	\$53.10	\$55.60	\$58.24	See Web	
<b>RG188-DS Coax, 50 Ohm</b>							
Part No. <a href="#">PE3778</a>				Cable Dia.	Attn. @ 1 GHz	Power @ 1 GHz	80
1 piece price shown. See web or call for volume pricing.				0.122" dia.	30 dB/100ft	160 W	
12"	24"	36"	48"	60"	-	Custom Len.	
\$54.39	\$54.71	\$61.44	\$61.52	\$68.75	-	See Web	

\*Coax Performance at 1 GHz Notes: Cable assembly max frequency may be lower than connector or coax max frequency



# For our complete selection of cable assemblies, please visit our website

RG213/U Coax, 50 Ohm							
Part No. <a href="#">PE35571</a>	Cable Dia.			Attn. @ 1 GHz	Power @ 1 GHz		
1 piece price shown. See web or call for volume pricing.	0.405" dia.			8 dB/100ft	190 W		
12"	24"	36"	48"	60"	-	Custom Len.	
\$170.04	\$171.55	\$172.99	\$174.48	\$176.00	-	See Web	
RG214/U Coax, 50 Ohm							
Part No. <a href="#">PE3121</a>	Cable Dia.			Attn. @ 1 GHz	Power @ 1 GHz		
1 piece price shown. See web or call for volume pricing.	0.425" dia.			7 dB/100ft	170 W		
6"	12"	18"	24"	36"	48"	Custom Len.	
\$197.63	\$197.63	\$201.29	\$204.95	\$212.28	\$219.60	See Web	
RG223/U Coax, 50 Ohm							
Part No. <a href="#">PE3377</a>	Cable Dia.			Attn. @ 1 GHz	Power @ 1 GHz		
1 piece price shown. See web or call for volume pricing.	0.210" dia.			13 dB/100ft	53 W		
6"	12"	18"	24"	36"	48"	Custom Len.	
\$38.53	\$38.53	\$39.98	\$41.42	\$44.32	\$47.22	See Web	
Part No. <a href="#">PE3W02458</a>	Cable Dia.			Attn. @ 1 GHz	Power @ 1 GHz		
1 piece price shown. See web or call for volume pricing.	0.209" dia.			13 dB/100ft	50 W		
12"	24"	36"	48"	60"	50CM	Custom Len.	
\$59.34	\$73.41	\$76.65	\$79.89	\$83.13	\$72.23	See Web	
RG316/U Coax, 50 Ohm							
Part No. <a href="#">PE3573</a>	Cable Dia.			Attn. @ 1 GHz	Power @ 1 GHz		
1 piece price shown. See web or call for volume pricing.	0.102" dia.			38 dB/100ft	160 W		
6"	12"	18"	24"	36"	48"	Custom Len.	
\$49.04	\$50.56	\$52.13	\$53.69	\$56.81	\$60.12	See Web	
RG316-DS Coax, 50 Ohm							
Part No. <a href="#">PE3704</a>	Cable Dia.			Attn. @ 1 GHz	Power @ 1 GHz		
1 piece price shown. See web or call for volume pricing.	0.114" dia.			26 dB/100ft	160 W		
12"	24"	36"	48"	60"	-	Custom Len.	
\$49.41	\$52.54	\$55.67	\$58.97	\$62.16	-	See Web	
RG400/U Coax, 50 Ohm							
Part No. <a href="#">PE3500</a>	Cable Dia.			Attn. @ 1 GHz	Power @ 1 GHz		
1 piece price shown. See web or call for volume pricing.	0.195" dia.			15 dB/100ft	650 W		
6"	12"	18"	24"	36"	48"	Custom Len.	
\$51.73	\$55.32	\$59.02	\$62.71	\$70.11	\$77.94	See Web	
PE-P086EAM Coax, 50 Ohm							
Part No. <a href="#">PE3CA1039</a>	Cable Dia.			Attn. @ 1 GHz	Power @ 1 GHz		
1 piece price shown. See web or call for volume pricing.	0.104" dia.			dB/100ft	W		
12"	24"	36"	50CM	100CM	-	Custom Len.	
\$57.97	\$70.84	\$84.45	\$75.45	\$99.64	-	See Web	
PE-P141 Coax, 50 Ohm							
Part No. <a href="#">PE300</a>	Cable Dia.			Attn. @ 1 GHz	Power @ 1 GHz		
1 piece price shown. See web or call for volume pricing.	0.163" dia.			11 dB/100ft	600 W		
12"	24"	36"	48"	60"	72"	Custom Len.	
\$114.89	\$129.70	\$141.04	\$147.01	\$164.64	\$176.21	See Web	
Part No. <a href="#">PE350</a>	Cable Dia.			Attn. @ 1 GHz	Power @ 1 GHz		
1 piece price shown. See web or call for volume pricing.	0.163" dia.			11 dB/100ft	600 W		
12"	24"	36"	48"	60"	72"	Custom Len.	
\$90.63	\$101.02	\$116.06	\$128.08	\$132.20	\$151.23	See Web	
PE-P195 Coax, 50 Ohm							
Part No. <a href="#">PE3138</a>	Cable Dia.			Attn. @ 1 GHz	Power @ 1 GHz		
1 piece price shown. See web or call for volume pricing.	0.195" dia.			13 dB/100ft	650 W		
6"	12"	18"	24"	36"	48"	Custom Len.	
\$65.16	\$69.80	\$74.59	\$79.38	\$88.96	\$99.10	See Web	
PE-P141FLX Coax, 50 Ohm							
Part No. <a href="#">PE3CA1035</a>	Cable Dia.			Attn. @ 1 GHz	Power @ 1 GHz		
1 piece price shown. See web or call for volume pricing.	0.163" dia.			dB/100ft	W		
50CM	12"	24"	36"	100CM	-	Custom Len.	
\$77.53	\$68.25	\$89.64	\$110.41	\$115.19	-	See Web	
PE-VNA-R Coax, 50 Ohm							
Part No. <a href="#">PE3VNA1801</a>	Cable Dia.			Attn. @ 1 GHz	Power @ 1 GHz		
1 piece price shown. See web or call for volume pricing.	0.430" dia.			dB/100ft	W		
24"	48"	-	-	-	-	Custom Len.	
\$776.91	\$866.24	-	-	-	-	See Web	
Standard Semi-Rigid Cable Assemblies							
PE-020SR Coax, 50 Ohm							
Part No. <a href="#">PE34191</a>	Cable Dia.			Attn. @ 1 GHz	Power @ 1 GHz		
1 piece price shown. See web or call for volume pricing.	" dia.			85 dB/100ft	3 W		
6"	12"	18"	24"	36"	48"	Custom Len.	
\$134.44	\$143.87	\$153.58	\$163.29	\$172.02	\$190.16	See Web	
PE-034SR Coax, 50 Ohm							
Part No. <a href="#">PE34193</a>	Cable Dia.			Attn. @ 1 GHz	Power @ 1 GHz		
1 piece price shown. See web or call for volume pricing.	" dia.			60 dB/100ft	10 W		
6"	12"	18"	24"	36"	48"	Custom Len.	
\$138.59	\$136.38	\$142.50	\$156.86	\$169.16	\$173.24	See Web	
PE-047SR Coax, 50 Ohm							
Part No. <a href="#">PE3656</a>	Cable Dia.			Attn. @ 1 GHz	Power @ 1 GHz		
1 piece price shown. See web or call for volume pricing.	" dia.			40 dB/100ft	32 W		
6"	12"	18"	24"	36"	48"	Custom Len.	
\$87.73	\$93.53	\$99.49	\$105.46	\$109.91	\$130.02	See Web	
PE-SR047AL Coax, 50 Ohm							
Part No. <a href="#">PE3387</a>	Cable Dia.			Attn. @ 1 GHz	Power @ 1 GHz		
1 piece price shown. See web or call for volume pricing.	0.047" dia.			41 dB/100ft	32 W		
6"	12"	18"	24"	36"	48"	Custom Len.	
\$89.09	\$94.03	\$93.24	\$97.79	\$114.38	\$115.94	See Web	

PE-SR402AL Coax, 50 Ohm							
Part No. <a href="#">PE34180</a>	Cable Dia.			Attn. @ 1 GHz	Power @ 1 GHz		
1 piece price shown. See web or call for volume pricing.	0.141" dia.			13 dB/100ft	450 W		
6"	12"	18"	24"	36"	48"	Custom Len.	
\$51.17	\$56.12	\$61.20	\$66.29	\$76.47	\$87.23	See Web	
PE-SR402TN Coax, 50 Ohm							
Part No. <a href="#">PE3C1015</a>	Cable Dia.			Attn. @ 1 GHz	Power @ 1 GHz		
1 piece price shown. See web or call for volume pricing.	" dia.			12 dB/100ft	W		
12"	24"	36"	48"	60"	72"	Custom Len.	
\$49.99	\$56.94	\$56.95	\$62.28	\$67.62	\$72.94	See Web	
PE-SR405AL Coax, 50 Ohm							
Part No. <a href="#">PE34182</a>	Cable Dia.			Attn. @ 1 GHz	Power @ 1 GHz		
1 piece price shown. See web or call for volume pricing.	" dia.			23 dB/100ft	130 W		
6"	12"	18"	24"	36"	48"	Custom Len.	
\$48.07	\$52.69	\$57.45	\$62.20	\$71.71	\$76.60	See Web	
RG401/U Coax, 50 Ohm							
Part No. <a href="#">PE33003</a>	Cable Dia.			Attn. @ 1 GHz	Power @ 1 GHz		
1 piece price shown. See web or call for volume pricing.	" dia.			8 dB/100ft	1400 W		
6"	12"	18"	24"	36"	48"	Custom Len.	
\$133.86	\$144.87	\$156.20	\$158.61	\$190.20	\$214.19	See Web	
RG402/U Coax, 50 Ohm							
Part No. <a href="#">PE3492</a>	Cable Dia.			Attn. @ 1 GHz	Power @ 1 GHz		
1 piece price shown. See web or call for volume pricing.	" dia.			12 dB/100ft	650 W		
6"	12"	18"	24"	36"	48"	Custom Len.	
\$49.55	\$53.34	\$57.26	\$61.17	\$68.99	\$77.27	See Web	
RG405/U Coax, 50 Ohm							
Part No. <a href="#">PE3818</a>	Cable Dia.			Attn. @ 1 GHz	Power @ 1 GHz		
1 piece price shown. See web or call for volume pricing.	" dia.			22 dB/100ft	130 W		
6"	12"	18"	24"	36"	48"	Custom Len.	
\$47.24	\$50.85	\$54.56	\$58.28	\$65.71	\$73.56	See Web	
PE-SR401AL-STRAIGHT Coax, 50 Ohm							
Part No. <a href="#">PE34184</a>	Cable Dia.			Attn. @ 1 GHz	Power @ 1 GHz		
1 piece price shown. See web or call for volume pricing.	0.250" dia.			8 dB/100ft	1400 W		
6"	12"	18"	24"	36"	48"	Custom Len.	
\$132.80	\$140.77	\$141.88	\$150.95	\$169.08	\$187.23	See Web	
Standard Flexible Cable Assemblies							
RG55B/U Coax, 53 Ohm							
Part No. <a href="#">PE3572</a>	Cable Dia.			Attn. @ 1 GHz	Power @ 1 GHz		
1 piece price shown. See web or call for volume pricing.	0.202" dia.			17 dB/100ft	53 W		
6"	12"	18"	24"	36"	48"	Custom Len.	
\$42.20	\$44.74	\$43.33	\$47.33	\$46.69	\$48.93	See Web	
RG59B/U Coax, 75 Ohm							
Part No. <a href="#">PE3814</a>	Cable Dia.			Attn. @ 1 GHz	Power @ 1 GHz		
1 piece price shown. See web or call for volume pricing.	0.242" dia.			12 dB/100ft	77 W		
6"	12"	18"	24"	36"	48"	Custom Len.	
\$67.25	\$71.29	\$67.73	\$68.22	\$69.18	\$70.14	See Web	
RG179B/U Coax, 75 Ohm							
Part No. <a href="#">PE3739</a>	Cable Dia.			Attn. @ 1 GHz	Power @ 1 GHz		
1 piece price shown. See web or call for volume pricing.	0.100" dia.			25 dB/100ft	200 W		
6"	12"	18"	24"	36"	48"	Custom Len.	
\$46.76	\$47.99	\$49.28	\$50.56	\$53.11	\$52.38	See Web	
RG187A/U Coax, 75 Ohm							
Part No. <a href="#">PE38059</a>	Cable Dia.			Attn. @ 1 GHz	Power @ 1 GHz		
1 piece price shown. See web or call for volume pricing.	0.110" dia.			25 dB/100ft	200 W		
12"	24"	36"	48"	60"	-	Custom Len.	
\$48.45	\$55.17	\$54.76	\$57.87	\$60.99	-	See Web	
RG62A/U Coax, 93 Ohm							
Part No. <a href="#">PE3899</a>	Cable Dia.			Attn. @ 1 GHz	Power @ 1 GHz		
1 piece price shown. See web or call for volume pricing.	0.242" dia.			13 dB/100ft	77 W		
6"	12"	18"	24"	36"	48"	Custom Len.	
\$67.72	\$67.72	\$68.41	\$69.09	\$70.46	\$71.84	See Web	
RG180B/U Coax, 95 Ohm							
Part No. <a href="#">PE3245</a>	Cable Dia.			Attn. @ 1 GHz	Power @ 1 GHz		
1 piece price shown. See web or call for volume pricing.	0.141" dia.			dB/100ft	250 W		
12"	24"	36"	48"	60"	-	Custom Len.	
\$63.63	\$64.02	\$68.01	\$76.84	\$81.25	-	See Web	
SMA MALE TO SMA MALE RIGHT ANGLE							
Precision Flexible Cable Assemblies							
PE-P141 Coax, 50 Ohm							
Part No. <a href="#">PE351</a>	Cable Dia.			Attn. @ 1 GHz	Power @ 1 GHz		
1 piece price shown. See web or call for volume pricing.	0.163" dia.			dB/100ft	W		
6"	12"	24"	36"	48"	60"	Custom Len.	
\$164.93	\$170.45	\$174.60	\$193.16	\$205.17	\$216.75	See Web	
Part No. <a href="#">PE3C0806</a>	Cable Dia.			Attn. @ 1 GHz	Power @ 1 GHz		
1 piece price shown. See web or call for volume pricing.	0.163" dia.			11 dB/100ft	550 W		
12"	24"	36"	48"	60"	72"	Custom Len.	
\$140.27	\$151.57	\$162.88	\$174.20	\$185.50	\$196.81	See Web	
Low Loss Flexible Cable Assemblies							
PE-C195 Coax, 50 Ohm							

Cable Assemblies

See Our Website For Current Pricing & Real-Time Stock Availability!

Continued on Next Page

For Custom Lengths, Metric Lengths or Special Configurations, Please call (949) 261-1920



Technical Support  
+1 (949) 261-1920



Same-Day Shipping,  
Even Custom Cable Assemblies

# For our complete selection of cable assemblies, please visit our website

Cable Assemblies  
See Our Website For Current Pricing & Real-Time Stock Availability!

Part No.	Cable Dia.				Attn. @ 1 GHz	Power @ 1 GHz
Part No. <a href="#">PE36475</a>	0.195" dia.				11 dB/100ft	150 W
1 piece price shown. See web or call for volume pricing.	12"	24"	36"	48"	60"	Custom Len.
	\$46.37	\$47.15	\$44.37	\$45.07	\$45.79	See Web
<b>PE-C240 Coax, 50 Ohm</b>						
Part No. <a href="#">PE38624</a>	0.240" dia.				9 dB/100ft	250 W
1 piece price shown. See web or call for volume pricing.	12"	24"	36"	48"	60"	Custom Len.
	\$66.53	\$67.67	\$64.83	\$67.61	\$70.43	See Web
<b>LMR-240 Coax, 50 Ohm</b>						
Part No. <a href="#">PE3C0104</a>	0.240" dia.				8 dB/100ft	W
1 piece price shown. See web or call for volume pricing.	12"	24"	36"	48"	60"	Custom Len.
	\$42.20	\$41.55	\$42.52	\$45.19	\$46.17	See Web
<b>PE-P142LL-27478 Coax, 50 Ohm</b>						
Part No. <a href="#">PE3M0128</a>	0.195" dia.				48"	60"
1 piece price shown. See web or call for volume pricing.	12"	18"	24"	36"	48"	60"
	\$447.98	\$456.45	\$464.93	\$481.89	\$498.84	\$515.80
<b>PE-P160LL-27478 Coax, 50 Ohm</b>						
Part No. <a href="#">PE3M0182</a>	0.160" dia.				36"	Custom Len.
1 piece price shown. See web or call for volume pricing.	8"	12"	18"	24"	30"	36"
	\$446.55	\$451.46	\$458.81	\$466.16	\$473.51	\$480.86
<b>PE-P300LL-27478 Coax, 50 Ohm</b>						
Part No. <a href="#">PE3M0226</a>	0.300" dia.				dB/100ft	W
1 piece price shown. See web or call for volume pricing.	12"	18"	24"	36"	48"	60"
	\$517.63	\$531.78	\$545.93	\$574.23	\$602.54	\$630.84
<b>PE-P160LL Coax, 50 Ohm</b>						
Part No. <a href="#">PE3C5246</a>	0.160" dia.				dB/100ft	W
1 piece price shown. See web or call for volume pricing.	12"	24"	36"	48"	60"	50CM
	\$242.55	\$263.27	\$283.98	\$304.70	\$325.40	\$255.82
<b>Low PIM Corrugated Cable Assemblies</b>						
<b>SPP-250-LLPL Coax, 50 Ohm</b>						
Part No. <a href="#">PE3C5894</a>	0.280" dia.				dB/100ft	W
1 piece price shown. See web or call for volume pricing.	12"	24"	36"	48"	60"	50CM
	\$58.81	\$64.39	\$101.14	\$75.55	\$81.13	\$62.38
<b>Low Loss Test Flexible Cable Assemblies</b>						
<b>PE-P300LL Coax, 50 Ohm</b>						
Part No. <a href="#">PE3C3248</a>	0.300" dia.				6 dB/100ft	W
1 piece price shown. See web or call for volume pricing.	12"	24"	36"	48"	60"	50CM
	\$332.67	\$357.87	\$383.08	\$408.28	\$433.48	\$348.81
Part No. <a href="#">PE3C1722</a>	0.300" dia.				6 dB/100ft	W
1 piece price shown. See web or call for volume pricing.	12"	24"	36"	48"	60"	50CM
	\$260.98	\$286.92	\$312.84	\$338.79	\$364.72	\$277.59
<b>Standard Formable Cable Assemblies</b>						
<b>PE-SR047FL Coax, 50 Ohm</b>						
Part No. <a href="#">PE34197</a>	0.047" dia.				36 dB/100ft	32 W
1 piece price shown. See web or call for volume pricing.	6"	12"	18"	24"	36"	48"
	\$120.52	\$127.76	\$124.20	\$127.89	\$135.26	\$142.63
<b>PE-SR401FL Coax, 50 Ohm</b>						
Part No. <a href="#">PE34202</a>	" dia.				7 dB/100ft	279 W
1 piece price shown. See web or call for volume pricing.	6"	12"	18"	24"	36"	48"
	\$144.63	\$145.44	\$153.61	\$161.77	\$175.41	\$190.82
<b>PE-SR402FL Coax, 50 Ohm</b>						
Part No. <a href="#">PE39425</a>	" dia.				12 dB/100ft	400 W
1 piece price shown. See web or call for volume pricing.	6"	9"	12"	18"	24"	Custom Len.
	\$43.20	\$41.24	\$43.20	\$47.38	\$51.56	See Web
Part No. <a href="#">PE3483</a>	" dia.				12 dB/100ft	400 W
1 piece price shown. See web or call for volume pricing.	6"	12"	18"	24"	36"	48"
	\$56.62	\$60.54	\$64.58	\$68.62	\$76.70	\$87.54
<b>PE-SR402FLJ Coax, 50 Ohm</b>						
Part No. <a href="#">PE39439</a>	0.161" dia.				12 dB/100ft	450 W
1 piece price shown. See web or call for volume pricing.	6"	9"	12"	18"	24"	Custom Len.
	\$51.02	\$47.24	\$51.02	\$55.34	\$59.66	See Web
<b>PE-SR405FL Coax, 50 Ohm</b>						
Part No. <a href="#">PE39417</a>	" dia.				23 dB/100ft	105 W
1 piece price shown. See web or call for volume pricing.	6"	9"	12"	18"	24"	Custom Len.
	\$49.10	\$46.45	\$49.10	\$54.68	\$60.26	See Web
Part No. <a href="#">PE3958</a>	" dia.				23 dB/100ft	130 W
1 piece price shown. See web or call for volume pricing.	6"	12"	18"	24"	36"	48"
	\$73.16	\$74.21	\$79.56	\$84.91	\$95.60	\$106.30

Part No.	Cable Dia.				Attn. @ 1 GHz	Power @ 1 GHz
Part No. <a href="#">PE3W03751</a>	0.098" dia.				20 dB/100ft	122 W
1 piece price shown. See web or call for volume pricing.	12"	24"	36"	48"	60"	50CM
	\$65.54	\$74.49	\$83.44	\$92.40	\$101.35	\$71.28
Part No. <a href="#">PE3W02993</a>	0.098" dia.				20 dB/100ft	122 W
1 piece price shown. See web or call for volume pricing.	12"	24"	36"	48"	60"	50CM
	\$48.24	\$57.19	\$66.14	\$75.10	\$84.06	\$53.98
<b>Standard Flexible Cable Assemblies</b>						
<b>RG58C/U Coax, 50 Ohm</b>						
Part No. <a href="#">PE3319</a>	0.195" dia.				20 dB/100ft	44 W
1 piece price shown. See web or call for volume pricing.	6"	12"	18"	24"	36"	48"
	\$55.58	\$55.97	\$56.38	\$56.78	\$53.29	\$54.03
<b>RG142B/U Coax, 50 Ohm</b>						
Part No. <a href="#">PE3512</a>	0.195" dia.				13 dB/100ft	650 W
1 piece price shown. See web or call for volume pricing.	6"	12"	18"	24"	36"	48"
	\$52.59	\$55.54	\$58.59	\$61.62	\$67.70	\$68.64
<b>RG174A/U Coax, 50 Ohm</b>						
Part No. <a href="#">PE3420</a>	0.100" dia.				32 dB/100ft	16 W
1 piece price shown. See web or call for volume pricing.	6"	12"	18"	24"	36"	48"
	\$63.85	\$64.13	\$64.42	\$64.71	\$65.29	\$61.81
<b>RG178B/U Coax, 50 Ohm</b>						
Part No. <a href="#">PE3865</a>	0.072" dia.				44 dB/100ft	78 W
1 piece price shown. See web or call for volume pricing.	6"	12"	18"	24"	36"	48"
	\$80.57	\$81.08	\$75.56	\$76.03	\$76.99	\$77.96
<b>RG188A/U Coax, 50 Ohm</b>						
Part No. <a href="#">PE3W04442</a>	0.110" dia.				26 dB/100ft	160 W
1 piece price shown. See web or call for volume pricing.	12"	24"	36"	48"	60"	50CM
	\$54.25	\$56.92	\$59.59	\$62.26	\$64.93	\$55.95
Part No. <a href="#">PE3510</a>	0.110" dia.				26 dB/100ft	160 W
1 piece price shown. See web or call for volume pricing.	6"	12"	18"	24"	36"	48"
	\$64.93	\$66.14	\$62.34	\$63.46	\$71.13	\$73.76
<b>RG188-DS Coax, 50 Ohm</b>						
Part No. <a href="#">PE3779</a>	0.122" dia.				30 dB/100ft	160 W
1 piece price shown. See web or call for volume pricing.	6"	12"	18"	24"	36"	48"
	\$53.50	\$55.21	\$56.97	\$58.72	\$57.91	\$61.31
<b>RG223/U Coax, 50 Ohm</b>						
Part No. <a href="#">PE3429</a>	0.210" dia.				13 dB/100ft	53 W
1 piece price shown. See web or call for volume pricing.	6"	12"	18"	24"	36"	48"
	\$57.71	\$59.21	\$60.77	\$62.33	\$65.45	\$68.74
<b>RG316/U Coax, 50 Ohm</b>						
Part No. <a href="#">PE3513</a>	0.098" dia.				38 dB/100ft	160 W
1 piece price shown. See web or call for volume pricing.	6"	12"	18"	24"	36"	48"
	\$64.30	\$65.82	\$67.38	\$66.17	\$72.07	\$75.37
<b>RG316-DS Coax, 50 Ohm</b>						
Part No. <a href="#">PE3344</a>	0.114" dia.				26 dB/100ft	160 W
1 piece price shown. See web or call for volume pricing.	6"	12"	18"	24"	36"	48"
	\$56.60	\$56.60	\$58.06	\$59.50	\$62.42	\$65.33
<b>RG400/U Coax, 50 Ohm</b>						
Part No. <a href="#">PE3003</a>	0.195" dia.				15 dB/100ft	600 W
1 piece price shown. See web or call for volume pricing.	6"	12"	18"	24"	36"	48"
	\$63.79	\$67.38	\$71.08	\$74.78	\$82.17	\$90.00
<b>PE-P086EAM Coax, 50 Ohm</b>						
Part No. <a href="#">PE3CA1040</a>	0.104" dia.				dB/100ft	W
1 piece price shown. See web or call for volume pricing.	12"	24"	36"	50CM	100CM	Custom Len.
	\$62.55	\$74.80	\$87.03	\$70.31	\$90.46	See Web
<b>PE-P141EAM Coax, 50 Ohm</b>						
Part No. <a href="#">PE3CA1036</a>	0.163" dia.				dB/100ft	W
1 piece price shown. See web or call for volume pricing.	12"	24"	36"	50CM	100CM	Custom Len.
	\$72.34	\$91.43	\$110.52	\$84.57	\$115.89	See Web
<b>Standard Semi-Rigid Cable Assemblies</b>						
<b>PE-020SR Coax, 50 Ohm</b>						
Part No. <a href="#">PE34204</a>	" dia.				85 dB/100ft	3 W
1 piece price shown. See web or call for volume pricing.	6"	12"	18"	24"	36"	48"
	\$136.98	\$160.38	\$154.56	\$163.38	\$180.97	\$198.55
<b>PE-047SR Coax, 50 Ohm</b>						

\*Coax Performance at 1 GHz Notes: Cable assembly max frequency may be lower than connector or coax max frequency

For our complete selection of cable assemblies, please visit our website

Part No.	Cable Dia.				Attn. @ 1 GHz	Power @ 1 GHz
<b>PE3230</b>	" dia.				40 dB/100ft	32 W
1 piece price shown. See web or call for volume pricing.						
6"	12"	18"	24"	36"	48"	Custom Len.
\$123.51	\$123.51	\$128.62	\$133.74	\$143.97	\$154.22	See Web
<b>PE-SR047AL Coax, 50 Ohm</b>						
<b>PE3393</b>	0.047" dia.				41 dB/100ft	32 W
1 piece price shown. See web or call for volume pricing.						
6"	12"	18"	24"	36"	48"	Custom Len.
\$110.99	\$115.37	\$119.77	\$124.13	\$132.95	\$141.77	See Web
<b>PE-SR402AL Coax, 50 Ohm</b>						
<b>PE34195</b>	0.141" dia.				13 dB/100ft	450 W
1 piece price shown. See web or call for volume pricing.						
6"	12"	18"	24"	36"	48"	Custom Len.
\$65.96	\$70.89	\$71.59	\$76.28	\$85.71	\$95.11	See Web
<b>RG401/U Coax, 50 Ohm</b>						
<b>PE34220</b>	" dia.				8 dB/100ft	870 W
1 piece price shown. See web or call for volume pricing.						
6"	12"	18"	24"	36"	48"	Custom Len.
\$146.07	\$157.08	\$153.43	\$164.05	\$185.36	\$206.66	See Web
<b>RG402/U Coax, 50 Ohm</b>						
<b>PE3821</b>	" dia.				12 dB/100ft	650 W
1 piece price shown. See web or call for volume pricing.						
6"	12"	18"	24"	36"	48"	Custom Len.
\$67.42	\$71.22	\$69.59	\$73.25	\$80.55	\$87.86	See Web
<b>RG405/U Coax, 50 Ohm</b>						
<b>PE3822</b>	" dia.				22 dB/100ft	130 W
1 piece price shown. See web or call for volume pricing.						
6"	12"	18"	24"	36"	48"	Custom Len.
\$71.59	\$71.59	\$75.04	\$78.47	\$92.17	\$92.20	See Web
<b>PE-SR401AL-STRAIGHT Coax, 50 Ohm</b>						
<b>PE34200</b>	0.250" dia.				8 dB/100ft	1400 W
1 piece price shown. See web or call for volume pricing.						
6"	12"	18"	24"	36"	48"	Custom Len.
\$135.97	\$139.08	\$147.85	\$156.66	\$174.25	\$191.84	See Web
<b>Standard Flexible Cable Assemblies</b>						
<b>RG59B/U Coax, 75 Ohm</b>						
<b>PE3137</b>	0.242" dia.				12 dB/100ft	77 W
1 piece price shown. See web or call for volume pricing.						
6"	12"	18"	24"	36"	48"	Custom Len.
\$68.69	\$69.16	\$69.57	\$70.06	\$70.95	\$71.87	See Web
<b>RG179B/U Coax, 75 Ohm</b>						
<b>PE3459</b>	0.100" dia.				25 dB/100ft	200 W
1 piece price shown. See web or call for volume pricing.						
6"	12"	18"	24"	36"	48"	Custom Len.
\$62.65	\$62.65	\$63.83	\$65.01	\$67.38	\$69.74	See Web
<b>RG62A/U Coax, 93 Ohm</b>						
<b>PE3411</b>	0.242" dia.				13 dB/100ft	77 W
1 piece price shown. See web or call for volume pricing.						
6"	12"	18"	24"	36"	48"	Custom Len.
\$68.92	\$69.57	\$70.24	\$70.90	\$72.23	\$73.54	See Web
<b>RG180B/U Coax, 95 Ohm</b>						
<b>PE3352</b>	0.145" dia.				dB/100ft	250 W
1 piece price shown. See web or call for volume pricing.						
6"	12"	18"	24"	36"	48"	Custom Len.
\$59.32	\$61.24	\$63.15	\$65.07	\$68.99	\$72.82	See Web
<b>SMA MALE TO SMA FEMALE</b>						
<b>Precision Formable Cable Assemblies</b>						
<b>PE-SR402FL Coax, 50 Ohm</b>						
<b>PE39426</b>	" dia.				12 dB/100ft	450 W
1 piece price shown. See web or call for volume pricing.						
6"	9"	12"	18"	24"	-	Custom Len.
\$40.29	\$36.62	\$40.29	\$44.31	\$48.33	-	See Web
<b>PE-SR405FL Coax, 50 Ohm</b>						
<b>PE39418</b>	" dia.				23 dB/100ft	130 W
1 piece price shown. See web or call for volume pricing.						
6"	9"	12"	18"	24"	-	Custom Len.
\$37.92	\$40.21	\$40.21	\$45.56	\$50.90	-	See Web
<b>PE-SR405FLJ Coax, 50 Ohm</b>						
<b>PE39432</b>	0.098" dia.				20 dB/100ft	130 W
1 piece price shown. See web or call for volume pricing.						
6"	9"	12"	18"	24"	-	Custom Len.
\$37.91	\$35.76	\$37.91	\$42.23	\$46.55	-	See Web
<b>PE-80TEST Coax, 50 Ohm</b>						
<b>PE3TC0102</b>	0.195" dia.				dB/100ft	W
1 piece price shown. See web or call for volume pricing.						
24"	48"	72"	-	-	-	Custom Len.
\$356.84	\$442.58	\$528.33	-	-	-	See Web
<b>PE3TC0202</b>	0.195" dia.				dB/100ft	W
1 piece price shown. See web or call for volume pricing.						
24"	48"	72"	-	-	-	Custom Len.
\$553.52	\$639.26	\$725.00	-	-	-	See Web



Low Loss Flexible Cable Assemblies						
<b>PE-C100-LSZH Coax, 50 Ohm</b>						
<b>PE37995</b>	0.109" dia.				25 dB/100ft	W
1 piece price shown. See web or call for volume pricing.						
12"	24"	36"	48"	60"	-	Custom Len.
\$52.91	\$50.18	\$51.39	\$52.58	\$58.32	-	See Web
<b>PE-C195 Coax, 50 Ohm</b>						
<b>PE36201</b>	0.195" dia.				11 dB/100ft	150 W
1 piece price shown. See web or call for volume pricing.						
12"	24"	36"	48"	60"	-	Custom Len.
\$46.98	\$47.76	\$45.75	\$46.46	\$47.17	-	See Web
<b>PE-C240 Coax, 50 Ohm</b>						
<b>PE38638</b>	0.240" dia.				9 dB/100ft	250 W
1 piece price shown. See web or call for volume pricing.						
12"	24"	36"	48"	60"	-	Custom Len.
\$54.61	\$55.59	\$57.16	\$59.92	\$62.52	-	See Web
<b>LMR-240 Coax, 50 Ohm</b>						
<b>PE3W02466</b>	0.240" dia.				dB/100ft	W
1 piece price shown. See web or call for volume pricing.						
12"	24"	36"	48"	60"	50CM	Custom Len.
\$48.90	\$49.84	\$50.78	\$51.72	\$52.67	\$49.51	See Web
<b>PE-P142LL Coax, 50 Ohm</b>						
<b>PE340</b>	0.195" dia.				7 dB/100ft	820 W
1 piece price shown. See web or call for volume pricing.						
12"	24"	36"	48"	60"	50CM	Custom Len.
\$151.44	\$167.68	\$183.92	\$200.15	\$216.39	\$161.85	See Web
<b>PE-P142LL-27478 Coax, 50 Ohm</b>						
<b>PE3M0126</b>	0.195" dia.				dB/100ft	W
1 piece price shown. See web or call for volume pricing.						
12"	18"	24"	36"	48"	60"	Custom Len.
\$414.58	\$423.06	\$431.54	\$448.49	\$465.45	\$482.41	See Web
<b>LMR-240-UF Coax, 50 Ohm</b>						
<b>PE3W04971</b>	0.240" dia.				9 dB/100ft	W
1 piece price shown. See web or call for volume pricing.						
12"	24"	36"	48"	60"	50CM	Custom Len.
\$47.37	\$48.71	\$50.06	\$51.41	\$52.76	\$48.23	See Web
<b>Low PIM Corrugated Cable Assemblies</b>						
<b>SPP-250-LLPL Coax, 50 Ohm</b>						
<b>PE3C5883</b>	0.280" dia.				dB/100ft	W
1 piece price shown. See web or call for volume pricing.						
12"	24"	36"	48"	60"	50CM	Custom Len.
\$58.08	\$63.66	\$69.24	\$74.82	\$80.40	\$61.65	See Web
<b>Standard Formable Cable Assemblies</b>						
<b>PE-SR047FL Coax, 50 Ohm</b>						
<b>PE34228</b>	0.047" dia.				36 dB/100ft	32 W
1 piece price shown. See web or call for volume pricing.						
6"	12"	18"	24"	36"	48"	Custom Len.
\$95.72	\$95.72	\$109.35	\$103.09	\$110.47	\$117.83	See Web
<b>PE-SR401FL Coax, 50 Ohm</b>						
<b>PE34233</b>	" dia.				8 dB/100ft	1400 W
1 piece price shown. See web or call for volume pricing.						
6"	12"	18"	24"	36"	48"	Custom Len.
\$116.18	\$116.18	\$123.88	\$131.58	\$146.99	\$162.37	See Web
<b>PE-SR402FL Coax, 50 Ohm</b>						
<b>PE3443</b>	" dia.				12 dB/100ft	450 W
1 piece price shown. See web or call for volume pricing.						
6"	12"	18"	24"	36"	48"	Custom Len.
\$57.06	\$60.99	\$60.23	\$64.00	\$71.55	\$79.08	See Web
<b>PE-SR402FLJ Coax, 50 Ohm</b>						
<b>PE39440</b>	0.161" dia.				12 dB/100ft	450 W
1 piece price shown. See web or call for volume pricing.						
6"	9"	12"	18"	24"	-	Custom Len.
\$38.66	\$37.17	\$38.66	\$43.15	\$47.64	-	See Web
<b>PE-SR405FL Coax, 50 Ohm</b>						
<b>PE3651</b>	" dia.				23 dB/100ft	130 W
1 piece price shown. See web or call for volume pricing.						
6"	12"	18"	24"	36"	48"	Custom Len.
\$69.64	\$69.64	\$80.89	\$86.56	\$91.03	\$101.72	See Web
<b>Standard Flexible Cable Assemblies</b>						
<b>RG58C/U Coax, 50 Ohm</b>						
<b>PE3078</b>	0.195" dia.				20 dB/100ft	44 W
1 piece price shown. See web or call for volume pricing.						
6"	12"	18"	24"	36"	48"	Custom Len.
\$53.09	\$57.34	\$53.47	\$53.83	\$58.96	\$55.31	See Web
<b>RG142B/U Coax, 50 Ohm</b>						
<b>PE3611</b>	0.195" dia.				13 dB/100ft	650 W
1 piece price shown. See web or call for volume pricing.						
6"	12"	18"	24"	36"	48"	Custom Len.
\$51.47	\$54.42	\$52.36	\$55.21	\$68.58	\$66.67	See Web
<b>RG174A/U Coax, 50 Ohm</b>						

Cable Assemblies

See Our Website For Current Pricing & Real-Time Stock Availability!

Continued on Next Page

For Custom Lengths, Metric Lengths or Special Configurations, Please call (949) 261-1920



Technical Support  
+1 (949) 261-1920



Same-Day Shipping,  
Even Custom Cable Assemblies

# For our complete selection of cable assemblies, please visit our website

Cable Assemblies  
See Our Website For Current Pricing & Real-Time Stock Availability!

Part No.	Cable Dia.				Attn. @ 1 GHz	Power @ 1 GHz
Part No. <b>PE3715</b>	0.100" dia.				32 dB/100ft	16 W
1 piece price shown. See web or call for volume pricing.						
6"	12"	18"	24"	36"	48"	Custom Len.
\$56.09	\$56.37	\$56.66	\$53.60	\$57.52	\$58.13	See Web
<b>RG178B/U Coax, 50 Ohm</b>						
Part No. <b>PE3056</b>	0.072" dia.				44 dB/100ft	55 W
1 piece price shown. See web or call for volume pricing.						
6"	12"	18"	24"	36"	48"	Custom Len.
\$69.31	\$65.87	\$66.36	\$70.88	\$71.94	\$68.75	See Web
<b>RG188A/U Coax, 50 Ohm</b>						
Part No. <b>PE3706</b>	0.110" dia.				26 dB/100ft	160 W
1 piece price shown. See web or call for volume pricing.						
6"	12"	18"	24"	36"	48"	Custom Len.
\$56.02	\$56.02	\$57.12	\$58.24	\$60.46	\$62.68	See Web
<b>RG223/U Coax, 50 Ohm</b>						
Part No. <b>PE3697</b>	0.210" dia.				13 dB/100ft	53 W
1 piece price shown. See web or call for volume pricing.						
6"	12"	18"	24"	36"	48"	Custom Len.
\$46.96	\$48.47	\$50.03	\$51.59	\$54.70	\$54.43	See Web
<b>RG316/U Coax, 50 Ohm</b>						
Part No. <b>PE3832</b>	0.098" dia.				38 dB/100ft	160 W
1 piece price shown. See web or call for volume pricing.						
6"	12"	18"	24"	36"	48"	Custom Len.
\$57.81	\$59.33	\$60.90	\$62.45	\$61.75	\$68.89	See Web
<b>RG316-DS Coax, 50 Ohm</b>						
Part No. <b>PE3171</b>	0.114" dia.				26 dB/100ft	85 W
1 piece price shown. See web or call for volume pricing.						
6"	12"	18"	24"	36"	48"	Custom Len.
\$63.14	\$59.87	\$61.32	\$67.78	\$70.90	\$68.61	See Web
<b>RG400/U Coax, 50 Ohm</b>						
Part No. <b>PE3864</b>	0.195" dia.				15 dB/100ft	650 W
1 piece price shown. See web or call for volume pricing.						
6"	12"	18"	24"	36"	48"	Custom Len.
\$57.72	\$57.72	\$61.21	\$64.69	\$71.66	\$78.63	See Web
<b>PE-P141 Coax, 50 Ohm</b>						
Part No. <b>PE3C1876</b>	0.163" dia.				11 dB/100ft	550 W
1 piece price shown. See web or call for volume pricing.						
12"	24"	36"	48"	60"	50CM	Custom Len.
\$53.70	\$65.50	\$77.30	\$89.10	\$100.91	\$61.25	See Web
<b>PE-P195 Coax, 50 Ohm</b>						
Part No. <b>PE3160</b>	0.195" dia.				13 dB/100ft	650 W
1 piece price shown. See web or call for volume pricing.						
6"	12"	18"	24"	36"	48"	Custom Len.
\$62.57	\$66.32	\$66.98	\$71.42	\$80.27	\$89.13	See Web
<b>PE-VNA-R Coax, 50 Ohm</b>						
Part No. <b>PE3VNA1802</b>	0.430" dia.				dB/100ft	W
1 piece price shown. See web or call for volume pricing.						
24"	48"	-	-	-	-	Custom Len.
\$791.80	\$880.58	-	-	-	-	See Web
<b>Standard Semi-Rigid Cable Assemblies</b>						
<b>PE-020SR Coax, 50 Ohm</b>						
Part No. <b>PE34224</b>	" dia.				85 dB/100ft	3 W
1 piece price shown. See web or call for volume pricing.						
6"	12"	18"	24"	36"	48"	Custom Len.
\$135.96	\$144.77	\$153.54	\$162.35	\$179.94	\$197.52	See Web
<b>PE-034SR Coax, 50 Ohm</b>						
Part No. <b>PE34226</b>	" dia.				60 dB/100ft	10 W
1 piece price shown. See web or call for volume pricing.						
6"	12"	18"	24"	36"	48"	Custom Len.
\$146.41	\$146.41	\$152.55	\$158.70	\$170.99	\$192.80	See Web
<b>PE-047SR Coax, 50 Ohm</b>						
Part No. <b>PE3188</b>	" dia.				40 dB/100ft	32 W
1 piece price shown. See web or call for volume pricing.						
6"	12"	18"	24"	36"	48"	Custom Len.
\$98.63	\$98.63	\$103.75	\$108.88	\$119.11	\$129.35	See Web
<b>PE-SR047AL Coax, 50 Ohm</b>						
Part No. <b>PE3253</b>	" dia.				41 dB/100ft	32 W
1 piece price shown. See web or call for volume pricing.						
6"	12"	18"	24"	36"	48"	Custom Len.
\$92.54	\$91.96	\$96.34	\$100.73	\$109.54	\$118.31	See Web
<b>PE-SR402AL Coax, 50 Ohm</b>						
Part No. <b>PE34235</b>	0.141" dia.				13 dB/100ft	450 W
1 piece price shown. See web or call for volume pricing.						
6"	12"	18"	24"	36"	48"	Custom Len.
\$56.96	\$61.89	\$66.98	\$68.93	\$78.33	\$87.75	See Web
<b>PE-SR405AL Coax, 50 Ohm</b>						
Part No. <b>PE34237</b>	" dia.				23 dB/100ft	130 W
1 piece price shown. See web or call for volume pricing.						
6"	12"	18"	24"	36"	48"	Custom Len.
\$58.30	\$62.51	\$66.70	\$70.84	\$79.23	\$87.59	See Web
<b>RG401/U Coax, 50 Ohm</b>						
Part No. <b>PE33896</b>	" dia.				8 dB/100ft	870 W
1 piece price shown. See web or call for volume pricing.						
6"	12"	18"	24"	36"	48"	Custom Len.
\$122.93	\$122.93	\$141.65	\$144.89	\$166.83	\$188.78	See Web

Part No.	Cable Dia.				Attn. @ 1 GHz	Power @ 1 GHz
Part No. <b>PE3823</b>	" dia.				12 dB/100ft	650 W
1 piece price shown. See web or call for volume pricing.						
6"	12"	18"	24"	36"	48"	Custom Len.
\$56.99	\$57.34	\$64.70	\$64.65	\$71.96	\$84.71	See Web
<b>RG405/U Coax, 50 Ohm</b>						
Part No. <b>PE3824</b>	" dia.				22 dB/100ft	130 W
1 piece price shown. See web or call for volume pricing.						
6"	12"	18"	24"	36"	48"	Custom Len.
\$67.26	\$65.62	\$69.06	\$72.50	\$79.36	\$86.24	See Web
<b>PE-SR401AL-STRAIGHT Coax, 50 Ohm</b>						
Part No. <b>PE34230</b>	0.250" dia.				8 dB/100ft	1400 W
1 piece price shown. See web or call for volume pricing.						
6"	12"	18"	24"	36"	48"	Custom Len.
\$103.48	\$112.26	\$121.06	\$129.84	\$147.42	\$165.02	See Web
<b>Standard Flexible Cable Assemblies</b>						
<b>RG55B/U Coax, 53 Ohm</b>						
Part No. <b>PE3093</b>	0.202" dia.				17 dB/100ft	53 W
1 piece price shown. See web or call for volume pricing.						
6"	12"	18"	24"	36"	48"	Custom Len.
\$40.54	\$41.62	\$42.70	\$43.76	\$45.93	\$48.10	See Web
<b>RG59B/U Coax, 75 Ohm</b>						
Part No. <b>PE3333</b>	0.242" dia.				12 dB/100ft	77 W
1 piece price shown. See web or call for volume pricing.						
6"	12"	18"	24"	36"	48"	Custom Len.
\$69.30	\$69.30	\$69.78	\$74.50	\$71.22	\$72.19	See Web
<b>RG179B/U Coax, 75 Ohm</b>						
Part No. <b>PE3102</b>	0.100" dia.				29 dB/100ft	W
1 piece price shown. See web or call for volume pricing.						
6"	12"	18"	24"	36"	48"	Custom Len.
\$56.28	\$61.91	\$57.46	\$58.64	\$61.01	\$69.74	See Web
<b>SMA MALE TO SMA FEMALE BULKHEAD</b>						
SEE MOUNTING HOLE SECTION ON PAGE 369						
<b>Low Loss Flexible Cable Assemblies</b>						
<b>PE-C100-LSZH Coax, 50 Ohm</b>						
Part No. <b>PE38240</b>	0.109" dia.				25 dB/100ft	W
1 piece price shown. See web or call for volume pricing.						
12"	24"	36"	48"	60"	-	Custom Len.
\$52.68	\$49.97	\$51.18	\$52.39	\$53.58	-	See Web
<b>PE-C195 Coax, 50 Ohm</b>						
Part No. <b>PE36417</b>	0.195" dia.				11 dB/100ft	150 W
1 piece price shown. See web or call for volume pricing.						
12"	24"	36"	48"	60"	-	Custom Len.
\$39.75	\$41.07	\$42.39	\$43.71	\$45.09	-	See Web
<b>LMR-195 Coax, 50 Ohm</b>						
Part No. <b>PE3C5767</b>	0.195" dia.				12 dB/100ft	W
1 piece price shown. See web or call for volume pricing.						
12"	24"	36"	48"	60"	50CM	Custom Len.
\$49.24	\$49.86	\$50.17	\$50.79	\$51.41	\$49.33	See Web
<b>PE-P142LL-27478 Coax, 50 Ohm</b>						
Part No. <b>PE3M0127</b>	0.195" dia.				dB/100ft	W
1 piece price shown. See web or call for volume pricing.						
12"	18"	24"	36"	48"	60"	Custom Len.
\$447.24	\$455.72	\$464.19	\$481.15	\$498.11	\$515.06	See Web
<b>PE-P160LL-27478 Coax, 50 Ohm</b>						
Part No. <b>PE3M0181</b>	0.160" dia.				dB/100ft	W
1 piece price shown. See web or call for volume pricing.						
8"	12"	18"	24"	30"	36"	Custom Len.
\$442.62	\$447.52	\$454.87	\$462.22	\$469.58	\$476.92	See Web
<b>PE-P160LL Coax, 50 Ohm</b>						
Part No. <b>PE3C5242</b>	0.160" dia.				50CM	W
1 piece price shown. See web or call for volume pricing.						
12"	24"	36"	48"	60"	50CM	Custom Len.
\$222.45	\$243.17	\$263.87	\$284.59	\$305.30	\$235.72	See Web
<b>Standard Formable Cable Assemblies</b>						
<b>PE-SR401FL Coax, 50 Ohm</b>						
Part No. <b>PE34249</b>	" dia.				8 dB/100ft	1400 W
1 piece price shown. See web or call for volume pricing.						
6"	12"	18"	24"	36"	48"	Custom Len.
\$111.46	\$118.97	\$126.42	\$133.92	\$148.86	\$163.80	See Web
<b>PE-SR402FLJ Coax, 50 Ohm</b>						
Part No. <b>PE39441</b>	0.161" dia.				12 dB/100ft	450 W
1 piece price shown. See web or call for volume pricing.						
6"	9"	12"	18"	24"	-	Custom Len.
\$40.78	\$37.07	\$40.78	\$45.10	\$49.42	-	See Web
<b>PE-SR405FL Coax, 50 Ohm</b>						
Part No. <b>PE39419</b>	" dia.				23 dB/100ft	105 W
1 piece price shown. See web or call for volume pricing.						
4"	6"	9"	12"	18"	24"	Custom Len.
\$43.56	\$49.56	\$46.90	\$49.56	\$55.14	\$60.72	See Web



\*Coax Performance at 1 GHz Notes: Cable assembly max frequency may be lower than connector or coax max frequency

# For our complete selection of cable assemblies, please visit our website

Part No. <a href="#">PE3961</a>				Cable Dia.	Attn. @ 1 GHz	Power @ 1 GHz
1 piece price shown. See web or call for volume pricing.						
6"	12"	18"	24"	36"	48"	Custom Len.
\$65.02	\$70.53	\$76.20	\$75.99	\$86.69	\$97.39	See Web
PE-SR405FLJ Coax, 50 Ohm						
Part No. <a href="#">PE39433</a>				Cable Dia.	Attn. @ 1 GHz	Power @ 1 GHz
1 piece price shown. See web or call for volume pricing.						
6"	9"	12"	18"	24"	-	Custom Len.
\$18.37	\$39.46	\$18.37	\$22.69	\$27.01	-	See Web
Standard Flexible Cable Assemblies						
RG58C/U Coax, 50 Ohm						
Part No. <a href="#">PE3956</a>				Cable Dia.	Attn. @ 1 GHz	Power @ 1 GHz
1 piece price shown. See web or call for volume pricing.						
6"	12"	18"	24"	36"	48"	Custom Len.
\$47.38	\$47.74	\$48.10	\$48.45	\$49.18	\$49.96	See Web
RG142B/U Coax, 50 Ohm						
Part No. <a href="#">PE3494</a>				Cable Dia.	Attn. @ 1 GHz	Power @ 1 GHz
1 piece price shown. See web or call for volume pricing.						
6"	12"	18"	24"	36"	48"	Custom Len.
\$54.76	\$57.71	\$60.75	\$63.78	\$64.90	\$76.30	See Web
RG174A/U Coax, 50 Ohm						
Part No. <a href="#">PE3184</a>				Cable Dia.	Attn. @ 1 GHz	Power @ 1 GHz
1 piece price shown. See web or call for volume pricing.						
6"	12"	18"	24"	36"	48"	Custom Len.
\$59.45	\$59.73	\$60.02	\$60.31	\$60.90	\$61.51	See Web
RG178B/U Coax, 50 Ohm						
Part No. <a href="#">PE3959</a>				Cable Dia.	Attn. @ 1 GHz	Power @ 1 GHz
1 piece price shown. See web or call for volume pricing.						
6"	12"	18"	24"	36"	48"	Custom Len.
\$53.23	\$56.42	\$56.95	\$57.48	\$58.54	\$56.10	See Web
RG188A/U Coax, 50 Ohm						
Part No. <a href="#">PE3051</a>				Cable Dia.	Attn. @ 1 GHz	Power @ 1 GHz
1 piece price shown. See web or call for volume pricing.						
6"	12"	18"	24"	36"	48"	Custom Len.
\$50.87	\$52.09	\$50.25	\$54.58	\$53.57	\$59.71	See Web
RG223/U Coax, 50 Ohm						
Part No. <a href="#">PE3553</a>				Cable Dia.	Attn. @ 1 GHz	Power @ 1 GHz
1 piece price shown. See web or call for volume pricing.						
6"	12"	18"	24"	36"	48"	Custom Len.
\$54.08	\$50.54	\$51.98	\$58.70	\$56.32	\$65.11	See Web
RG316/U Coax, 50 Ohm						
Part No. <a href="#">PE3835</a>				Cable Dia.	Attn. @ 1 GHz	Power @ 1 GHz
1 piece price shown. See web or call for volume pricing.						
6"	12"	18"	24"	36"	48"	Custom Len.
\$53.53	\$55.05	\$56.62	\$53.86	\$56.76	\$59.65	See Web
RG400/U Coax, 50 Ohm						
Part No. <a href="#">PE3924</a>				Cable Dia.	Attn. @ 1 GHz	Power @ 1 GHz
1 piece price shown. See web or call for volume pricing.						
6"	12"	18"	24"	36"	48"	Custom Len.
\$62.97	\$66.57	\$65.11	\$73.96	\$75.57	\$82.54	See Web
PE-P086EAM Coax, 50 Ohm						
Part No. <a href="#">PE3CA1042</a>				Cable Dia.	Attn. @ 1 GHz	Power @ 1 GHz
1 piece price shown. See web or call for volume pricing.						
12"	24"	36"	50CM	100CM	-	Custom Len.
\$62.55	\$74.80	\$97.48	\$70.31	\$113.14	-	See Web
PE-P195 Coax, 50 Ohm						
Part No. <a href="#">PE3799</a>				Cable Dia.	Attn. @ 1 GHz	Power @ 1 GHz
1 piece price shown. See web or call for volume pricing.						
6"	12"	18"	24"	36"	48"	Custom Len.
\$55.06	\$59.32	\$63.64	\$72.45	\$82.03	\$85.05	See Web
Standard Semi-Rigid Cable Assemblies						
PE-SR402AL Coax, 50 Ohm						
Part No. <a href="#">PE34252</a>				Cable Dia.	Attn. @ 1 GHz	Power @ 1 GHz
1 piece price shown. See web or call for volume pricing.						
6"	12"	18"	24"	36"	48"	Custom Len.
\$62.77	\$61.55	\$66.25	\$70.96	\$80.37	\$89.79	See Web
PE-SR405AL Coax, 50 Ohm						
Part No. <a href="#">PE34254</a>				Cable Dia.	Attn. @ 1 GHz	Power @ 1 GHz
1 piece price shown. See web or call for volume pricing.						
6"	12"	18"	24"	36"	48"	Custom Len.
\$58.54	\$58.47	\$67.91	\$66.82	\$75.22	\$83.57	See Web
RG401/U Coax, 50 Ohm						
Part No. <a href="#">PE34256</a>				Cable Dia.	Attn. @ 1 GHz	Power @ 1 GHz
1 piece price shown. See web or call for volume pricing.						
6"	12"	18"	24"	36"	48"	Custom Len.
\$114.65	\$125.27	\$135.96	\$146.58	\$167.89	\$189.18	See Web
RG402/U Coax, 50 Ohm						
Part No. <a href="#">PE3825</a>				Cable Dia.	Attn. @ 1 GHz	Power @ 1 GHz
1 piece price shown. See web or call for volume pricing.						
6"	12"	18"	24"	36"	48"	Custom Len.
\$60.28	\$59.34	\$62.99	\$66.64	\$73.95	\$81.25	See Web
Part No. <a href="#">PE3C2892</a>						
1 piece price shown. See web or call for volume pricing.						
6"	12"	18"	24"	36"	48"	Custom Len.
\$44.86	\$44.86	\$55.49	\$59.03	\$66.12	\$73.20	See Web

RG405/U Coax, 50 Ohm						
Part No. <a href="#">PE3826</a>				Cable Dia.	Attn. @ 1 GHz	Power @ 1 GHz
1 piece price shown. See web or call for volume pricing.						
6"	12"	18"	24"	36"	48"	Custom Len.
\$59.00	\$64.91	\$68.62	\$72.34	\$72.75	\$79.62	See Web
PE-SR401AL-STRAIGHT Coax, 50 Ohm						
Part No. <a href="#">PE34247</a>				Cable Dia.	Attn. @ 1 GHz	Power @ 1 GHz
1 piece price shown. See web or call for volume pricing.						
6"	12"	18"	24"	36"	48"	Custom Len.
\$128.92	\$128.92	\$137.99	\$147.06	\$165.20	\$183.35	See Web
Standard Flexible Cable Assemblies						
RG55B/U Coax, 53 Ohm						
Part No. <a href="#">PE3940</a>				Cable Dia.	Attn. @ 1 GHz	Power @ 1 GHz
1 piece price shown. See web or call for volume pricing.						
6"	12"	18"	24"	36"	48"	Custom Len.
\$49.66	\$49.66	\$50.80	\$51.92	\$54.16	\$56.40	See Web
RG59B/U Coax, 75 Ohm						
Part No. <a href="#">PE3871</a>				Cable Dia.	Attn. @ 1 GHz	Power @ 1 GHz
1 piece price shown. See web or call for volume pricing.						
6"	12"	18"	24"	36"	48"	Custom Len.
\$63.88	\$64.36	\$64.78	\$65.27	\$66.15	\$67.07	See Web
RG179B/U Coax, 75 Ohm						
Part No. <a href="#">PE3967</a>				Cable Dia.	Attn. @ 1 GHz	Power @ 1 GHz
1 piece price shown. See web or call for volume pricing.						
6"	12"	18"	24"	36"	48"	Custom Len.
\$57.86	\$57.86	\$59.06	\$60.23	\$62.59	\$70.31	See Web
SMA MALE TO REVERSE POLARITY SMA MALE						
						
Low Loss Flexible Cable Assemblies						
PE-C100-LSZH Coax, 50 Ohm						
Part No. <a href="#">PE37900</a>				Cable Dia.	Attn. @ 1 GHz	Power @ 1 GHz
1 piece price shown. See web or call for volume pricing.						
12"	24"	36"	48"	60"	-	Custom Len.
\$50.08	\$51.41	\$48.78	\$49.98	\$51.19	-	See Web
LMR-240 Coax, 50 Ohm						
Part No. <a href="#">PE3W00906</a>				Cable Dia.	Attn. @ 1 GHz	Power @ 1 GHz
1 piece price shown. See web or call for volume pricing.						
12"	24"	36"	48"	60"	50CM	Custom Len.
\$57.33	\$58.28	\$59.21	\$60.16	\$61.10	\$57.93	See Web
Standard Flexible Cable Assemblies						
RG58C/U Coax, 50 Ohm						
Part No. <a href="#">PE34116</a>				Cable Dia.	Attn. @ 1 GHz	Power @ 1 GHz
1 piece price shown. See web or call for volume pricing.						
12"	24"	36"	48"	60"	72"	Custom Len.
\$59.61	\$60.42	\$56.66	\$57.39	\$58.13	\$58.87	See Web
RG142B/U Coax, 50 Ohm						
Part No. <a href="#">PE34614</a>				Cable Dia.	Attn. @ 1 GHz	Power @ 1 GHz
1 piece price shown. See web or call for volume pricing.						
12"	24"	36"	48"	60"	72"	Custom Len.
\$52.21	\$57.93	\$63.66	\$69.41	\$75.13	\$80.87	See Web
RG174A/U Coax, 50 Ohm						
Part No. <a href="#">PE34331</a>				Cable Dia.	Attn. @ 1 GHz	Power @ 1 GHz
1 piece price shown. See web or call for volume pricing.						
12"	24"	36"	48"	60"	72"	Custom Len.
\$54.76	\$51.15	\$51.59	\$52.01	\$52.45	\$52.89	See Web
RG178B/U Coax, 50 Ohm						
Part No. <a href="#">PE35208</a>				Cable Dia.	Attn. @ 1 GHz	Power @ 1 GHz
1 piece price shown. See web or call for volume pricing.						
12"	24"	36"	48"	60"	72"	Custom Len.
\$71.97	\$73.03	\$67.37	\$68.32	\$69.28	\$70.24	See Web
RG188A/U Coax, 50 Ohm						
Part No. <a href="#">PE35210</a>				Cable Dia.	Attn. @ 1 GHz	Power @ 1 GHz
1 piece price shown. See web or call for volume pricing.						
12"	24"	36"	48"	60"	72"	Custom Len.
\$52.52	\$54.74	\$56.96	\$59.18	\$61.40	\$63.62	See Web
RG223/U Coax, 50 Ohm						
Part No. <a href="#">PE34398</a>				Cable Dia.	Attn. @ 1 GHz	Power @ 1 GHz
1 piece price shown. See web or call for volume pricing.						
12"	24"	36"	48"	60"	72"	Custom Len.
\$48.45	\$51.36	\$54.25	\$57.15	\$60.04	\$67.23	See Web
RG316/U Coax, 50 Ohm						
Part No. <a href="#">PE35212</a>				Cable Dia.	Attn. @ 1 GHz	Power @ 1 GHz
1 piece price shown. See web or call for volume pricing.						
12"	24"	36"	48"	60"	72"	Custom Len.
\$53.50	\$56.63	\$59.75	\$58.54	\$61.54	\$64.54	See Web
RG316-DS Coax, 50 Ohm						
Part No. <a href="#">PE36963</a>				Cable Dia.	Attn. @ 1 GHz	Power @ 1 GHz
1 piece price shown. See web or call for volume pricing.						
12"	24"	36"	48"	60"	-	Custom Len.
\$57.50	\$56.14	\$63.74	\$61.97	\$64.88	-	See Web

Cable Assemblies

See Our Website For Current Pricing & Real-Time Stock Availability!

For Custom Lengths, Metric Lengths or Special Configurations, Please call (949) 261-1920



Technical Support  
+1 (949) 261-1920



Same-Day Shipping,  
Even Custom Cable Assemblies

For our complete selection of cable assemblies, please visit our website

**SMA MALE TO REVERSE THREAD SMA MALE**



**Standard Flexible Cable Assemblies**

**RG58C/U Coax, 50 Ohm**

Part No. <a href="#">PE35351</a>	Cable Dia.	Attn. @ 1 GHz	Power @ 1 GHz
1 piece price shown. See web or call for volume pricing.			
12"	24"	36"	48"
\$51.10	\$51.83	\$52.54	\$53.26
60"	72"	84"	96"
\$53.99	\$54.76	\$55.53	\$56.30

**RG142B/U Coax, 50 Ohm**

Part No. <a href="#">PE35355</a>	Cable Dia.	Attn. @ 1 GHz	Power @ 1 GHz
1 piece price shown. See web or call for volume pricing.			
12"	24"	36"	48"
\$53.06	\$58.60	\$64.18	\$69.71
60"	72"	84"	96"
\$75.29	\$80.80	\$86.31	\$91.82

**RG223/U Coax, 50 Ohm**

Part No. <a href="#">PE35371</a>	Cable Dia.	Attn. @ 1 GHz	Power @ 1 GHz
1 piece price shown. See web or call for volume pricing.			
12"	24"	36"	48"
\$54.46	\$57.36	\$60.26	\$63.15
60"	72"	84"	96"
\$66.06	\$68.96	\$71.86	\$74.76

**RG316/U Coax, 50 Ohm**

Part No. <a href="#">PE35375</a>	Cable Dia.	Attn. @ 1 GHz	Power @ 1 GHz
1 piece price shown. See web or call for volume pricing.			
12"	24"	36"	48"
\$55.23	\$58.23	\$61.24	\$64.24
60"	72"	84"	96"
\$70.24	\$73.24	\$76.24	\$79.24

**SMA MALE TO SMB PLUG**



**Standard Formable Cable Assemblies**

**PE-SR405FL Coax, 50 Ohm**

Part No. <a href="#">PE34764</a>	Cable Dia.	Attn. @ 1 GHz	Power @ 1 GHz
1 piece price shown. See web or call for volume pricing.			
12"	24"	36"	48"
\$60.17	\$71.76	\$83.36	\$94.95
60"	72"	84"	96"
\$106.55	\$113.14	\$119.73	\$126.32

**Standard Flexible Cable Assemblies**

**PE-B100 Coax, 50 Ohm**

Part No. <a href="#">PE34455</a>	Cable Dia.	Attn. @ 1 GHz	Power @ 1 GHz
1 piece price shown. See web or call for volume pricing.			
6"	12"	18"	24"
\$52.13	\$55.25	\$58.37	\$61.49
36"	48"	60"	72"
\$66.31	\$69.43	\$72.55	\$75.67

**RG58C/U Coax, 50 Ohm**

Part No. <a href="#">PE3172</a>	Cable Dia.	Attn. @ 1 GHz	Power @ 1 GHz
1 piece price shown. See web or call for volume pricing.			
6"	12"	18"	24"
\$51.46	\$55.58	\$59.70	\$63.82
36"	48"	60"	72"
\$67.94	\$72.06	\$76.18	\$80.30

**RG142B/U Coax, 50 Ohm**

Part No. <a href="#">PE3181</a>	Cable Dia.	Attn. @ 1 GHz	Power @ 1 GHz
1 piece price shown. See web or call for volume pricing.			
6"	12"	18"	24"
\$49.93	\$49.93	\$55.97	\$55.67
36"	48"	60"	72"
\$65.08	\$67.13	\$69.18	\$71.23

**RG174A/U Coax, 50 Ohm**

Part No. <a href="#">PE3908</a>	Cable Dia.	Attn. @ 1 GHz	Power @ 1 GHz
1 piece price shown. See web or call for volume pricing.			
6"	12"	18"	24"
\$46.60	\$46.88	\$47.17	\$44.67
36"	48"	60"	72"
\$48.04	\$48.66	\$49.28	\$49.90

**RG178B/U Coax, 50 Ohm**

Part No. <a href="#">PE3548</a>	Cable Dia.	Attn. @ 1 GHz	Power @ 1 GHz
1 piece price shown. See web or call for volume pricing.			
6"	12"	18"	24"
\$61.46	\$61.98	\$57.86	\$58.35
36"	48"	60"	72"
\$64.10	\$60.26	\$56.42	\$52.58

**RG188A/U Coax, 50 Ohm**

Part No. <a href="#">PE3755</a>	Cable Dia.	Attn. @ 1 GHz	Power @ 1 GHz
1 piece price shown. See web or call for volume pricing.			
6"	12"	18"	24"
\$46.89	\$46.89	\$48.01	\$49.11
36"	48"	60"	72"
\$51.34	\$53.55	\$55.76	\$57.97

**RG188-DS Coax, 50 Ohm**

Part No. <a href="#">PE3722</a>	Cable Dia.	Attn. @ 1 GHz	Power @ 1 GHz
1 piece price shown. See web or call for volume pricing.			
6"	12"	18"	24"
\$41.64	\$41.64	\$43.35	\$45.05
36"	48"	60"	72"
\$48.45	\$51.86	\$55.27	\$58.68

**RG196A/U Coax, 50 Ohm**

Part No. <a href="#">PE34448</a>	Cable Dia.	Attn. @ 1 GHz	Power @ 1 GHz
1 piece price shown. See web or call for volume pricing.			
6"	12"	18"	24"
\$57.78	\$57.78	\$58.45	\$59.14
36"	48"	60"	72"
\$60.51	\$61.89	\$63.27	\$64.65

**RG223/U Coax, 50 Ohm**

Part No. <a href="#">PE3187</a>	Cable Dia.	Attn. @ 1 GHz	Power @ 1 GHz
1 piece price shown. See web or call for volume pricing.			
6"	12"	18"	24"
\$47.10	\$49.92	\$48.55	\$53.04
36"	48"	60"	72"
\$52.90	\$59.45	\$66.00	\$72.55

**RG316/U Coax, 50 Ohm**

Part No. <a href="#">PE3810</a>	Cable Dia.	Attn. @ 1 GHz	Power @ 1 GHz
1 piece price shown. See web or call for volume pricing.			
6"	12"	18"	24"
\$47.41	\$48.93	\$50.49	\$52.04
36"	48"	60"	72"
\$55.17	\$58.47	\$61.77	\$65.07

**RG316-DS Coax, 50 Ohm**

Part No. <a href="#">PE33657</a>	Cable Dia.	Attn. @ 1 GHz	Power @ 1 GHz
1 piece price shown. See web or call for volume pricing.			
6"	12"	18"	24"
\$49.52	\$52.49	\$54.05	\$55.62
36"	48"	60"	72"
\$58.73	\$62.05	\$65.37	\$68.69

**RG400/U Coax, 50 Ohm**

Part No. <a href="#">PE34452</a>	Cable Dia.	Attn. @ 1 GHz	Power @ 1 GHz
1 piece price shown. See web or call for volume pricing.			
6"	12"	18"	24"
\$59.06	\$64.96	\$62.54	\$66.03
36"	48"	60"	72"
\$79.75	\$79.97	\$80.19	\$80.41

**Standard Semi-Rigid Cable Assemblies**

**RG405/U Coax, 50 Ohm**

Part No. <a href="#">PE35527</a>	Cable Dia.	Attn. @ 1 GHz	Power @ 1 GHz
1 piece price shown. See web or call for volume pricing.			
12"	24"	36"	48"
\$52.91	\$64.56	\$66.64	\$73.52
60"	72"	84"	96"
\$80.38	\$83.50	\$86.62	\$89.74

**SMA MALE TO SMB PLUG RIGHT ANGLE**



**Low Loss Flexible Cable Assemblies**

**PE-C100-LSZH Coax, 50 Ohm**

Part No. <a href="#">PE3W00416</a>	Cable Dia.	Attn. @ 1 GHz	Power @ 1 GHz
1 piece price shown. See web or call for volume pricing.			
12"	24"	36"	48"
\$33.18	\$34.46	\$35.75	\$37.04
60"	72"	84"	96"
\$38.33	\$40.00	\$41.67	\$43.34

**Standard Flexible Cable Assemblies**

**RG174A/U Coax, 50 Ohm**

Part No. <a href="#">PE3W03030</a>	Cable Dia.	Attn. @ 1 GHz	Power @ 1 GHz
1 piece price shown. See web or call for volume pricing.			
12"	24"	36"	48"
\$37.47	\$38.03	\$38.59	\$39.15
60"	72"	84"	96"
\$39.71	\$37.82	\$35.93	\$34.04

Part No. <a href="#">PE3W04476</a>	Cable Dia.	Attn. @ 1 GHz	Power @ 1 GHz
1 piece price shown. See web or call for volume pricing.			
12"	24"	36"	48"
\$41.26	\$41.82	\$42.38	\$42.94
60"	72"	84"	96"
\$43.50	\$41.61	\$39.72	\$37.83

**SMA MALE TO SMB JACK**



**Standard Flexible Cable Assemblies**

**RG316/U Coax, 50 Ohm**

Part No. <a href="#">PE3W03014</a>	Cable Dia.	Attn. @ 1 GHz	Power @ 1 GHz
1 piece price shown. See web or call for volume pricing.			
12"	24"	36"	48"
\$39.25	\$42.53	\$45.81	\$49.09
60"	72"	84"	96"
\$52.38	\$41.35	\$30.32	\$19.29

**RG316-DS Coax, 50 Ohm**

Part No. <a href="#">PE3W05361</a>	Cable Dia.	Attn. @ 1 GHz	Power @ 1 GHz
1 piece price shown. See web or call for volume pricing.			
12"	24"	36"	48"
\$65.24	\$68.48	\$71.73	\$74.98
60"	72"	84"	96"
\$78.24	\$67.32	\$56.40	\$45.48

**SMA MALE TO SMC PLUG**



**Standard Flexible Cable Assemblies**

**RG58C/U Coax, 50 Ohm**

Part No. <a href="#">PE3210</a>	Cable Dia.	Attn. @ 1 GHz	Power @ 1 GHz
1 piece price shown. See web or call for volume pricing.			
6"	12"	18"	24"
\$54.99	\$54.99	\$55.36	\$55.73
36"	48"	60"	72"
\$56.47	\$57.20	\$57.93	\$58.66

**RG174A/U Coax, 50 Ohm**

Part No. <a href="#">PE3944</a>	Cable Dia.	Attn. @ 1 GHz	Power @ 1 GHz
1 piece price shown. See web or call for volume pricing.			
6"	12"	18"	24"
\$51.42	\$51.42	\$51.64	\$51.86
36"	48"	60"	72"
\$52.29	\$52.73	\$53.17	\$53.61

**RG178B/U Coax, 50 Ohm**

Part No. <a href="#">PE3561</a>	Cable Dia.	Attn. @ 1 GHz	Power @ 1 GHz
1 piece price shown. See web or call for volume pricing.			
6"	12"	18"	24"
\$53.06	\$53.56	\$54.04	\$54.51
36"	48"	60"	72"
\$55.48	\$56.43	\$57.38	\$58.33

**RG188A/U Coax, 50 Ohm**

Part No. <a href="#">PE3736</a>	Cable Dia.	Attn. @ 1 GHz	Power @ 1 GHz
1 piece price shown. See web or call for volume pricing.			
6"	12"	18"	24"
\$41.57	\$42.63	\$43.71	\$44.74
36"	48"	60"	72"
\$46.89	\$49.06	\$51.23	\$53.40

**RG188-DS Coax, 50 Ohm**

Cable Assemblies See Our Website For Current Pricing & Real-Time Stock Availability!

\*Coax Performance at 1 GHz Notes: Cable assembly max frequency may be lower than connector or coax max frequency

# For our complete selection of cable assemblies, please visit our website

Part No. <a href="#">PE34458</a>					Cable Dia.	Attn. @ 1 GHz	Power @ 1 GHz
1 piece price shown. See web or call for volume pricing.					0.122" dia.	30 dB/100ft	160 W
6"	12"	18"	24"	36"	48"	Custom Len.	
\$45.99	\$45.99	\$47.68	\$49.38	\$52.78	\$56.18	See Web	

Part No. <a href="#">PE3226</a>					Cable Dia.	Attn. @ 1 GHz	Power @ 1 GHz
1 piece price shown. See web or call for volume pricing.					0.209" dia.	13 dB/100ft	50 W
6"	12"	18"	24"	36"	48"	Custom Len.	
\$51.37	\$51.37	\$52.81	\$54.27	\$57.17	\$60.05	See Web	

Part No. <a href="#">PE3809</a>					Cable Dia.	Attn. @ 1 GHz	Power @ 1 GHz
1 piece price shown. See web or call for volume pricing.					0.098" dia.	38 dB/100ft	160 W
6"	12"	18"	24"	36"	48"	Custom Len.	
\$47.83	\$47.83	\$49.27	\$54.78	\$53.60	\$56.49	See Web	

Part No. <a href="#">PE34456</a>					Cable Dia.	Attn. @ 1 GHz	Power @ 1 GHz
1 piece price shown. See web or call for volume pricing.					0.114" dia.	26 dB/100ft	160 W
6"	12"	18"	24"	36"	48"	Custom Len.	
\$41.95	\$41.95	\$43.41	\$47.60	\$50.72	\$50.68	See Web	

## SMA MALE TO SMP FEMALE



### Standard Formable Cable Assemblies

Part No. <a href="#">PE36164</a>					Cable Dia.	Attn. @ 1 GHz	Power @ 1 GHz
1 piece price shown. See web or call for volume pricing.					0.047" dia.	36 dB/100ft	32 W
12"	24"	36"	48"	60"	72"	Custom Len.	
\$90.82	\$98.94	\$100.41	\$115.66	\$115.15	\$122.53	See Web	

Part No. <a href="#">PE36168</a>					Cable Dia.	Attn. @ 1 GHz	Power @ 1 GHz
1 piece price shown. See web or call for volume pricing.					" dia.	23 dB/100ft	130 W
12"	24"	36"	48"	60"	72"	Custom Len.	
\$83.30	\$94.64	\$105.99	\$112.18	\$129.55	\$133.57	See Web	

Part No. <a href="#">PE36166</a>					Cable Dia.	Attn. @ 1 GHz	Power @ 1 GHz
1 piece price shown. See web or call for volume pricing.					" dia.	22 dB/100ft	130 W
12"	24"	36"	48"	60"	72"	Custom Len.	
\$62.50	\$69.92	\$77.35	\$85.21	\$87.57	\$94.43	See Web	

## SMA MALE TO SMP FEMALE RIGHT ANGLE



### Standard Formable Cable Assemblies

Part No. <a href="#">PE3W06701</a>					Cable Dia.	Attn. @ 1 GHz	Power @ 1 GHz
1 piece price shown. See web or call for volume pricing.					0.105" dia.	20 dB/100ft	122 W
12"	24"	36"	48"	60"	50CM	Custom Len.	
\$68.05	\$77.00	\$85.96	\$94.91	\$103.87	\$73.79	See Web	

Part No. <a href="#">PE3C3028</a>					Cable Dia.	Attn. @ 1 GHz	Power @ 1 GHz
1 piece price shown. See web or call for volume pricing.					0.098" dia.	38 dB/100ft	160 W
12"	24"	36"	48"	60"	50CM	Custom Len.	
\$51.60	\$54.63	\$57.66	\$60.70	\$63.72	\$53.54	See Web	

Part No. <a href="#">PE3W05274</a>					Cable Dia.	Attn. @ 1 GHz	Power @ 1 GHz
1 piece price shown. See web or call for volume pricing.					0.098" dia.	58 dB/100ft	160 W
12"	24"	36"	48"	60"	50CM	Custom Len.	
\$46.07	\$60.17	\$63.45	\$66.73	\$70.02	\$58.99	See Web	

## SMA MALE TO SSMA MALE



### Low Loss Flexible Cable Assemblies

Part No. <a href="#">PE3W01283</a>					Cable Dia.	Attn. @ 1 GHz	Power @ 1 GHz
1 piece price shown. See web or call for volume pricing.					0.109" dia.	dB/100ft	W
12"	24"	36"	48"	60"	50CM	Custom Len.	
\$48.96	\$50.25	\$51.53	\$52.82	\$54.11	\$49.78	See Web	

Part No. <a href="#">PE35430</a>					Cable Dia.	Attn. @ 1 GHz	Power @ 1 GHz
1 piece price shown. See web or call for volume pricing.					0.100" dia.	32 dB/100ft	16 W
6"	12"	18"	24"	36"	48"	Custom Len.	
\$62.85	\$57.39	\$57.61	\$57.84	\$58.28	\$58.70	See Web	

Part No. <a href="#">PE3058</a>					Cable Dia.	Attn. @ 1 GHz	Power @ 1 GHz
1 piece price shown. See web or call for volume pricing.					0.072" dia.	44 dB/100ft	55 W
6"	12"	18"	24"	36"	48"	Custom Len.	
\$69.63	\$66.17	\$66.66	\$67.14	\$72.26	\$73.38	See Web	

Part No. <a href="#">PE3669</a>					Cable Dia.	Attn. @ 1 GHz	Power @ 1 GHz
1 piece price shown. See web or call for volume pricing.					0.098" dia.	58 dB/100ft	160 W
6"	12"	18"	24"	36"	48"	Custom Len.	
\$63.47	\$64.99	\$66.56	\$63.06	\$65.95	\$68.84	See Web	

Part No. <a href="#">PE37401</a>					Cable Dia.	Attn. @ 1 GHz	Power @ 1 GHz
1 piece price shown. See web or call for volume pricing.					0.114" dia.	26 dB/100ft	160 W
12"	24"	36"	48"	60"	-	Custom Len.	
\$63.82	\$66.94	\$64.90	\$67.82	\$70.72	-	See Web	

## SMA MALE TO SSMC PLUG



### Low Loss Flexible Cable Assemblies

Part No. <a href="#">PE3C4422</a>					Cable Dia.	Attn. @ 1 GHz	Power @ 1 GHz
1 piece price shown. See web or call for volume pricing.					0.110" dia.	24 dB/100ft	W
6"	12"	18"	24"	36"	48"	Custom Len.	
\$49.61	\$49.98	\$45.80	\$46.17	\$51.50	\$47.64	See Web	

Part No. <a href="#">PE3C4444</a>					Cable Dia.	Attn. @ 1 GHz	Power @ 1 GHz
1 piece price shown. See web or call for volume pricing.					0.105" dia.	20 dB/100ft	122 W
6"	12"	18"	24"	36"	48"	Custom Len.	
\$61.70	\$65.84	\$70.11	\$74.38	\$74.90	\$82.42	See Web	

Part No. <a href="#">PE3C4391</a>					Cable Dia.	Attn. @ 1 GHz	Power @ 1 GHz
1 piece price shown. See web or call for volume pricing.					0.072" dia.	44 dB/100ft	55 W
6"	12"	18"	24"	36"	48"	Custom Len.	
\$64.58	\$71.57	\$72.45	\$72.71	\$73.84	\$74.97	See Web	

Part No. <a href="#">PE3W06410</a>					Cable Dia.	Attn. @ 1 GHz	Power @ 1 GHz
1 piece price shown. See web or call for volume pricing.					0.080" dia.	49 dB/100ft	78 W
12"	24"	36"	48"	60"	50CM	Custom Len.	
\$65.98	\$67.46	\$68.95	\$70.43	\$71.92	\$66.92	See Web	

Part No. <a href="#">PE3C4405</a>					Cable Dia.	Attn. @ 1 GHz	Power @ 1 GHz
1 piece price shown. See web or call for volume pricing.					0.098" dia.	58 dB/100ft	160 W
6"	12"	18"	24"	36"	48"	Custom Len.	
\$55.64	\$57.05	\$62.04	\$59.85	\$62.66	\$65.45	See Web	

## SMA MALE TO SSMC PLUG RIGHT ANGLE



### Low Loss Flexible Cable Assemblies

Part No. <a href="#">PE3C4423</a>					Cable Dia.	Attn. @ 1 GHz	Power @ 1 GHz
1 piece price shown. See web or call for volume pricing.					0.110" dia.	24 dB/100ft	W
6"	12"	18"	24"	36"	48"	Custom Len.	
\$44.15	\$44.52	\$44.90	\$42.73	\$43.47	\$46.84	See Web	

Part No. <a href="#">PE3C4484</a>					Cable Dia.	Attn. @ 1 GHz	Power @ 1 GHz
1 piece price shown. See web or call for volume pricing.					0.105" dia.	20 dB/100ft	122 W
6"	12"	18"	24"	36"	48"	Custom Len.	
\$52.99	\$56.76	\$60.52	\$64.28	\$79.51	\$79.33	See Web	

Part No. <a href="#">PE3C4463</a>					Cable Dia.	Attn. @ 1 GHz	Power @ 1 GHz
1 piece price shown. See web or call for volume pricing.					0.072" dia.	44 dB/100ft	55 W
6"	18"	36"	12"	24"	48"	Custom Len.	
\$56.17	\$57.11	\$58.51	\$56.65	\$57.58	\$59.44	See Web	

Part No. <a href="#">PE3C4406</a>					Cable Dia.	Attn. @ 1 GHz	Power @ 1 GHz
1 piece price shown. See web or call for volume pricing.					0.098" dia.	58 dB/100ft	160 W
6"	12"	18"	24"	36"	48"	Custom Len.	
\$50.10	\$51.45	\$52.80	\$54.13	\$56.83	\$59.51	See Web	

Part No. <a href="#">PE3C4471</a>					Cable Dia.	Attn. @ 1 GHz	Power @ 1 GHz
1 piece price shown. See web or call for volume pricing.					0.114" dia.	9 dB/100ft	85 W
6"	12"	18"	24"	36"	48"	Custom Len.	
\$47.15	\$48.57	\$54.99	\$51.40	\$54.23	\$57.05	See Web	

## SMA MALE TO SSMC JACK



### Standard Flexible Cable Assemblies

Part No. <a href="#">PE3C4471</a>					Cable Dia.	Attn. @ 1 GHz	Power @ 1 GHz
1 piece price shown. See web or call for volume pricing.					0.114" dia.	9 dB/100ft	85 W
6"	12"	18"	24"	36"	48"	Custom Len.	
\$47.15	\$48.57	\$54.99	\$51.40	\$54.23	\$57.05	See Web	

Cable Assemblies

See Our Website For Current Pricing & Real-Time Stock Availability!

Continued on Next Page

For Custom Lengths, Metric Lengths or Special Configurations, Please call (949) 261-1920



Technical Support  
+1 (949) 261-1920



Same-Day Shipping,  
Even Custom Cable Assemblies

For our complete selection of cable assemblies, please visit our website

Part No.	Cable Dia.				Attn. @ 1 GHz	Power @ 1 GHz
Part No. <a href="#">PE3W04458</a>	0.114" dia.				9 dB/100ft	85 W
1 piece price shown. See web or call for volume pricing.	12"	24"	36"	48"	60"	50CM Custom Len.
	\$51.97	\$55.21	\$58.46	\$61.72	\$64.97	\$54.05 See Web
<b>SMA MALE TO SSMC JACK BULKHEAD</b>						
SEE MOUNTING HOLE SECTION ON PAGE 369						
<b>Standard Formable Cable Assemblies</b>						
<b>PE-SR405FLJ Coax, 50 Ohm</b>						
Part No. <a href="#">PE3C4445</a>	0.105" dia.				20 dB/100ft	122 W
1 piece price shown. See web or call for volume pricing.	6"	12"	18"	24"	36"	48" Custom Len.
	\$49.27	\$53.03	\$56.80	\$60.55	\$68.09	\$75.61 See Web
<b>Standard Flexible Cable Assemblies</b>						
<b>RG178B/U Coax, 50 Ohm</b>						
Part No. <a href="#">PE3C4392</a>	0.072" dia.				44 dB/100ft	55 W
1 piece price shown. See web or call for volume pricing.	6"	12"	18"	24"	36"	48" Custom Len.
	\$60.62	\$61.08	\$61.55	\$62.02	\$62.95	\$63.88 See Web
<b>SMA MALE TO TNC MALE</b>						
<b>Low Loss Flexible Cable Assemblies</b>						
<b>PE-C195 Coax, 50 Ohm</b>						
Part No. <a href="#">PE36058</a>	0.195" dia.				11 dB/100ft	150 W
1 piece price shown. See web or call for volume pricing.	12"	24"	36"	48"	60"	Custom Len.
	\$38.66	\$39.44	\$40.22	\$37.94	\$38.65	- See Web
<b>PE-C240 Coax, 50 Ohm</b>						
Part No. <a href="#">PE38642</a>	0.240" dia.				9 dB/100ft	250 W
1 piece price shown. See web or call for volume pricing.	12"	24"	36"	48"	60"	Custom Len.
	\$47.48	\$48.45	\$49.59	\$52.36	\$55.18	- See Web
<b>LMR-100A-PVC Coax, 50 Ohm</b>						
Part No. <a href="#">PE3C0114</a>	0.110" dia.				24 dB/100ft	W
1 piece price shown. See web or call for volume pricing.	12"	24"	36"	48"	60"	Custom Len.
	\$53.72	\$54.47	\$52.19	\$52.96	\$56.81	- See Web
<b>LMR-195 Coax, 50 Ohm</b>						
Part No. <a href="#">PE3C4164</a>	0.195" dia.				12 dB/100ft	W
1 piece price shown. See web or call for volume pricing.	12"	24"	36"	48"	60"	Custom Len.
	\$52.98	\$53.71	\$54.43	\$55.16	\$55.89	- See Web
<b>PE-P142LL Coax, 50 Ohm</b>						
Part No. <a href="#">PE3C0847</a>	0.195" dia.				7 dB/100ft	W
1 piece price shown. See web or call for volume pricing.	12"	24"	36"	48"	60"	50CM Custom Len.
	\$144.38	\$160.62	\$176.86	\$193.09	\$209.33	\$154.78 See Web
<b>PE-P142LL-2748 Coax, 50 Ohm</b>						
Part No. <a href="#">PE3M0129</a>	0.195" dia.				dB/100ft	W
1 piece price shown. See web or call for volume pricing.	12"	18"	24"	36"	48"	60" Custom Len.
	\$367.28	\$375.75	\$384.23	\$401.19	\$418.15	\$435.10 See Web
<b>PE-P160LL-2748 Coax, 50 Ohm</b>						
Part No. <a href="#">PE3M0183</a>	0.160" dia.				dB/100ft	W
1 piece price shown. See web or call for volume pricing.	8"	12"	18"	24"	30"	36" Custom Len.
	\$353.68	\$358.58	\$365.93	\$373.28	\$380.63	\$387.98 See Web
<b>PE-P300LL-2748 Coax, 50 Ohm</b>						
Part No. <a href="#">PE3M0227</a>	0.300" dia.				dB/100ft	W
1 piece price shown. See web or call for volume pricing.	12"	18"	24"	36"	48"	60" Custom Len.
	\$401.44	\$415.59	\$429.74	\$458.04	\$486.35	\$514.65 See Web
<b>PE-P160LL Coax, 50 Ohm</b>						
Part No. <a href="#">PE3C5258</a>	0.160" dia.				dB/100ft	W
1 piece price shown. See web or call for volume pricing.	12"	24"	36"	48"	60"	50CM Custom Len.
	\$205.44	\$226.16	\$246.87	\$267.58	\$288.29	\$218.71 See Web
<b>Low Loss Test Flexible Cable Assemblies</b>						
<b>PE-P300LL Coax, 50 Ohm</b>						
Part No. <a href="#">PE3C3242</a>	0.300" dia.				6 dB/100ft	W
1 piece price shown. See web or call for volume pricing.	12"	24"	36"	48"	60"	50CM Custom Len.
	\$218.25	\$243.46	\$268.66	\$293.87	\$319.07	\$234.40 See Web
<b>PE-P300LL Coax, 50 Ohm</b>						
Part No. <a href="#">PE338</a>	0.300" dia.				6 dB/100ft	W
1 piece price shown. See web or call for volume pricing.	12"	24"	48"	60"	50CM	100CM Custom Len.
	\$275.40	\$301.33	\$353.22	\$379.14	\$292.02	\$334.56 See Web
<b>Standard Formable Cable Assemblies</b>						
<b>PE-SR401FL Coax, 50 Ohm</b>						

Part No.	Cable Dia.				Attn. @ 1 GHz	Power @ 1 GHz
Part No. <a href="#">PE34422</a>	" dia.				8 dB/100ft	1400 W
1 piece price shown. See web or call for volume pricing.	6"	12"	18"	24"	36"	48" Custom Len.
	\$155.30	\$163.23	\$161.69	\$169.39	\$184.78	\$200.18 See Web
<b>PE-SR402FL Coax, 50 Ohm</b>						
Part No. <a href="#">PE33928</a>	" dia.				12 dB/100ft	450 W
1 piece price shown. See web or call for volume pricing.	6"	12"	18"	24"	36"	48" Custom Len.
	\$78.64	\$78.64	\$82.82	\$87.00	\$95.35	\$103.70 See Web
<b>PE-SR405FL Coax, 50 Ohm</b>						
Part No. <a href="#">PE34416</a>	" dia.				23 dB/100ft	130 W
1 piece price shown. See web or call for volume pricing.	6"	12"	18"	24"	36"	48" Custom Len.
	\$68.36	\$68.39	\$73.60	\$78.77	\$89.15	\$99.55 See Web
<b>Standard Flexible Cable Assemblies</b>						
<b>RG8A/U Coax, 50 Ohm</b>						
Part No. <a href="#">PE33669</a>	0.405" dia.				8 dB/100ft	190 W
1 piece price shown. See web or call for volume pricing.	12"	24"	36"	48"	60"	Custom Len.
	\$112.61	\$115.18	\$125.51	\$120.42	\$123.05	- See Web
<b>RG58C/U Coax, 50 Ohm</b>						
Part No. <a href="#">PE3154</a>	0.195" dia.				20 dB/100ft	44 W
1 piece price shown. See web or call for volume pricing.	12"	24"	36"	48"	60"	72" Custom Len.
	\$42.15	\$42.96	\$43.77	\$44.64	\$45.47	\$46.30 See Web
<b>RG141A/U Coax, 50 Ohm</b>						
Part No. <a href="#">PE37580</a>	0.190" dia.				13 dB/100ft	650 W
1 piece price shown. See web or call for volume pricing.	12"	24"	36"	48"	60"	Custom Len.
	\$48.22	\$54.15	\$60.11	\$66.04	\$72.03	- See Web
<b>RG142B/U Coax, 50 Ohm</b>						
Part No. <a href="#">PE3664</a>	0.195" dia.				13 dB/100ft	650 W
1 piece price shown. See web or call for volume pricing.	12"	24"	36"	48"	60"	72" Custom Len.
	\$45.46	\$54.27	\$60.35	\$66.78	\$72.97	\$74.12 See Web
<b>RG174A/U Coax, 50 Ohm</b>						
Part No. <a href="#">PE3178</a>	0.110" dia.				32 dB/100ft	17 W
1 piece price shown. See web or call for volume pricing.	12"	24"	36"	48"	60"	72" Custom Len.
	\$56.45	\$53.69	\$57.60	\$54.55	\$54.98	\$59.39 See Web
<b>RG178B/U Coax, 50 Ohm</b>						
Part No. <a href="#">PE34248</a>	0.072" dia.				44 dB/100ft	78 W
1 piece price shown. See web or call for volume pricing.	12"	24"	36"	48"	60"	72" Custom Len.
	\$70.25	\$71.31	\$68.18	\$69.15	\$70.09	\$71.06 See Web
<b>RG188A/U Coax, 50 Ohm</b>						
Part No. <a href="#">PE33361</a>	0.110" dia.				28 dB/100ft	160 W
1 piece price shown. See web or call for volume pricing.	12"	24"	36"	48"	60"	72" Custom Len.
	\$55.08	\$57.30	\$59.51	\$61.74	\$63.96	\$66.17 See Web
<b>RG213/U Coax, 50 Ohm</b>						
Part No. <a href="#">PE33673</a>	0.405" dia.				8 dB/100ft	190 W
1 piece price shown. See web or call for volume pricing.	12"	24"	36"	48"	60"	Custom Len.
	\$125.36	\$127.01	\$128.68	\$130.33	\$132.00	\$133.66 See Web
<b>RG214/U Coax, 50 Ohm</b>						
Part No. <a href="#">PE3176</a>	0.425" dia.				7 dB/100ft	170 W
1 piece price shown. See web or call for volume pricing.	12"	24"	36"	48"	60"	72" Custom Len.
	\$139.80	\$147.12	\$154.46	\$161.77	\$169.10	\$176.43 See Web
<b>RG223/U Coax, 50 Ohm</b>						
Part No. <a href="#">PE3535</a>	0.210" dia.				13 dB/100ft	53 W
1 piece price shown. See web or call for volume pricing.	12"	24"	36"	48"	60"	72" Custom Len.
	\$46.07	\$49.19	\$52.29	\$55.60	\$55.07	\$61.95 See Web
<b>RG316/U Coax, 50 Ohm</b>						
Part No. <a href="#">PE3174</a>	0.102" dia.				38 dB/100ft	W
1 piece price shown. See web or call for volume pricing.	12"	24"	36"	48"	60"	72" Custom Len.
	\$60.50	\$63.63	\$66.76	\$70.06	\$73.25	\$76.43 See Web
<b>RG316-DS Coax, 50 Ohm</b>						
Part No. <a href="#">PE34246</a>	0.114" dia.				26 dB/100ft	160 W
1 piece price shown. See web or call for volume pricing.	12"	24"	36"	48"	60"	72" Custom Len.
	\$50.19	\$53.11	\$56.02	\$58.92	\$61.83	\$71.14 See Web
<b>RG400/U Coax, 50 Ohm</b>						
Part No. <a href="#">PE33948</a>	0.195" dia.				15 dB/100ft	650 W
1 piece price shown. See web or call for volume pricing.	12"	24"	36"	48"	60"	72" Custom Len.
	\$57.82	\$65.22	\$72.61	\$80.44	\$87.97	\$89.40 See Web
<b>PE-P195 Coax, 50 Ohm</b>						
Part No. <a href="#">PE33396</a>	0.195" dia.				13 dB/100ft	650 W
1 piece price shown. See web or call for volume pricing.	12"	24"	36"	48"	60"	Custom Len.
	\$47.87	\$56.73	\$69.89	\$74.42	\$89.79	- See Web

Cable Assemblies See Our Website For Current Pricing & Real-Time Stock Availability!

\*Coax Performance at 1 GHz Notes: Cable assembly max frequency may be lower than connector or coax max frequency



For our complete selection of cable assemblies, please visit our website

Standard Semi-Rigid Cable Assemblies						
<b>PE-047SR Coax, 50 Ohm</b>						
Part No. <b>PE34408</b>	Cable Dia.	Attn. @ 1 GHz	Power @ 1 GHz			
1 piece price shown. See web or call for volume pricing.	" dia.	40 dB/100ft	32 W			
6" 12" 18" 24"	36" 48"	Custom Len.				
\$80.56 \$85.54 \$90.52 \$95.45	\$105.41 \$115.32	See Web				
<b>PE-SR402AL Coax, 50 Ohm</b>						
Part No. <b>PE34406</b>	Cable Dia.	Attn. @ 1 GHz	Power @ 1 GHz			
1 piece price shown. See web or call for volume pricing.	0.141" dia.	13 dB/100ft	450 W			
6" 12" 18" 24"	36" 48"	Custom Len.				
\$69.83 \$74.77 \$75.10 \$79.67	\$88.78 \$97.90	See Web				
<b>PE-SR405AL Coax, 50 Ohm</b>						
Part No. <b>PE34414</b>	Cable Dia.	Attn. @ 1 GHz	Power @ 1 GHz			
1 piece price shown. See web or call for volume pricing.	" dia.	23 dB/100ft	130 W			
6" 12" 18" 24"	36" 48"	Custom Len.				
\$62.20 \$66.40 \$70.59 \$74.74	\$83.15 \$91.48	See Web				
<b>RG401/U Coax, 50 Ohm</b>						
Part No. <b>PE34418</b>	Cable Dia.	Attn. @ 1 GHz	Power @ 1 GHz			
1 piece price shown. See web or call for volume pricing.	" dia.	8 dB/100ft	870 W			
6" 12" 18" 24"	36" 48"	Custom Len.				
\$149.73 \$160.73 \$162.25 \$172.93	\$194.24 \$215.48	See Web				
<b>RG402/U Coax, 50 Ohm</b>						
Part No. <b>PE3089</b>	Cable Dia.	Attn. @ 1 GHz	Power @ 1 GHz			
1 piece price shown. See web or call for volume pricing.	" dia.	11 dB/100ft	450 W			
6" 12" 18" 24"	36" 48"	Custom Len.				
\$71.25 \$71.25 \$74.90 \$78.55	\$85.86 \$93.17	See Web				
<b>RG405/U Coax, 50 Ohm</b>						
Part No. <b>PE33420</b>	Cable Dia.	Attn. @ 1 GHz	Power @ 1 GHz			
1 piece price shown. See web or call for volume pricing.	" dia.	22 dB/100ft	130 W			
6" 12" 18" 24"	36" 48"	Custom Len.				
\$69.83 \$69.83 \$77.74 \$76.71	\$83.58 \$90.44	See Web				
<b>PE-SR401AL-STRAIGHT Coax, 50 Ohm</b>						
Part No. <b>PE34420</b>	Cable Dia.	Attn. @ 1 GHz	Power @ 1 GHz			
1 piece price shown. See web or call for volume pricing.	0.250" dia.	8 dB/100ft	1400 W			
6" 12" 18" 24"	36" 48"	Custom Len.				
\$161.01 \$156.79 \$165.86 \$174.93	\$193.07 \$211.22	See Web				
<b>Standard Flexible Cable Assemblies</b>						
<b>RG55B/U Coax, 53 Ohm</b>						
Part No. <b>PE34250</b>	Cable Dia.	Attn. @ 1 GHz	Power @ 1 GHz			
1 piece price shown. See web or call for volume pricing.	0.202" dia.	17 dB/100ft	53 W			
12" 24" 36" 48"	60" 72"	Custom Len.				
\$42.61 \$44.84 \$47.09 \$49.33	\$51.58 \$53.81	See Web				
<b>RG59B/U Coax, 75 Ohm</b>						
Part No. <b>PE36848</b>	Cable Dia.	Attn. @ 1 GHz	Power @ 1 GHz			
1 piece price shown. See web or call for volume pricing.	0.242" dia.	12 dB/100ft	77 W			
12" 24" 36" 48"	60"	Custom Len.				
\$48.64 \$49.59 \$52.66 \$51.50	\$52.47 -	See Web				
<b>SMA MALE TO TNC MALE RIGHT ANGLE</b>						
<b>Low Loss Flexible Cable Assemblies</b>						
<b>PE-P142LL Coax, 50 Ohm</b>						
Part No. <b>PE3C0780</b>	Cable Dia.	Attn. @ 1 GHz	Power @ 1 GHz			
1 piece price shown. See web or call for volume pricing.	0.195" dia.	7 dB/100ft	W			
12" 24" 36" 48"	60" 50CM	Custom Len.				
\$225.01 \$241.25 \$257.47 \$273.71	\$289.95 \$235.42	See Web				
<b>PE-P142LL-27478 Coax, 50 Ohm</b>						
Part No. <b>PE3M0131</b>	Cable Dia.	Attn. @ 1 GHz	Power @ 1 GHz			
1 piece price shown. See web or call for volume pricing.	0.195" dia.	dB/100ft	W			
12" 18" 24" 36"	48" 60"	Custom Len.				
\$473.95 \$482.43 \$490.91 \$507.86	\$524.82 \$541.78	See Web				
<b>PE-P160LL-27478 Coax, 50 Ohm</b>						
Part No. <b>PE3M0185</b>	Cable Dia.	Attn. @ 1 GHz	Power @ 1 GHz			
1 piece price shown. See web or call for volume pricing.	0.160" dia.	dB/100ft	W			
8" 12" 18" 24"	30" 36"	Custom Len.				
\$438.69 \$443.59 \$450.94 \$458.29	\$465.64 \$472.99	See Web				
<b>PE-P300LL-27478 Coax, 50 Ohm</b>						
Part No. <b>PE3M0228</b>	Cable Dia.	Attn. @ 1 GHz	Power @ 1 GHz			
1 piece price shown. See web or call for volume pricing.	0.300" dia.	dB/100ft	W			
12" 18" 24" 36"	48" 60"	Custom Len.				
\$545.72 \$559.88 \$574.03 \$602.33	\$630.63 \$658.93	See Web				
<b>PE-P160LL Coax, 50 Ohm</b>						
Part No. <b>PE3C5259</b>	Cable Dia.	Attn. @ 1 GHz	Power @ 1 GHz			
1 piece price shown. See web or call for volume pricing.	0.160" dia.	dB/100ft	W			
12" 24" 36" 48"	60" 50CM	Custom Len.				
\$264.21 \$284.92 \$305.63 \$326.35	\$347.06 \$277.48	See Web				
<b>Standard Formable Cable Assemblies</b>						
<b>PE-SR405FLJ Coax, 50 Ohm</b>						
Part No. <b>PE3W07181</b>	Cable Dia.	Attn. @ 1 GHz	Power @ 1 GHz			
1 piece price shown. See web or call for volume pricing.	0.105" dia.	20 dB/100ft	122 W			
12" 24" 36" 48"	60" 50CM	Custom Len.				
\$49.04 \$57.99 \$66.94 \$75.90	\$84.86 \$54.78	See Web				

SMA MALE TO TNC FEMALE						
<b>Flexible Cable Assemblies</b>						
<b>LMR-195-FR Coax, 50 Ohm</b>						
Part No. <b>PE3C5480</b>	Cable Dia.	Attn. @ 1 GHz	Power @ 1 GHz			
1 piece price shown. See web or call for volume pricing.	0.195" dia.	12 dB/100ft	W			
12" 24" 36" 48"	60" 50CM	Custom Len.				
\$37.03 \$38.04 \$39.05 \$40.05	\$41.06 \$37.67	See Web				
<b>SMA MALE TO TNC FEMALE BULKHEAD</b>						
SEE MOUNTING HOLE SECTION ON PAGE 369						
<b>Precision Formable Cable Assemblies</b>						
<b>PE-SR405FL Coax, 50 Ohm</b>						
Part No. <b>PE39475</b>	Cable Dia.	Attn. @ 1 GHz	Power @ 1 GHz			
1 piece price shown. See web or call for volume pricing.	" dia.	23 dB/100ft	130 W			
6" 9" 12" 18"	24" -	Custom Len.				
\$52.06 \$49.31 \$52.06 \$57.86	\$63.66 -	See Web				
<b>PE-SR405FLJ Coax, 50 Ohm</b>						
Part No. <b>PE39489</b>	Cable Dia.	Attn. @ 1 GHz	Power @ 1 GHz			
1 piece price shown. See web or call for volume pricing.	0.098" dia.	20 dB/100ft	130 W			
6" 9" 12" 18"	24" -	Custom Len.				
\$47.86 \$45.14 \$47.86 \$52.34	\$56.83 -	See Web				
<b>Low Loss Flexible Cable Assemblies</b>						
<b>PE-P142LL Coax, 50 Ohm</b>						
Part No. <b>PE3C2449</b>	Cable Dia.	Attn. @ 1 GHz	Power @ 1 GHz			
1 piece price shown. See web or call for volume pricing.	0.195" dia.	10 dB/100ft	W			
12" 24" 36" 48"	60" 50CM	Custom Len.				
\$178.75 \$194.99 \$211.22 \$227.46	\$243.70 \$189.15	See Web				
<b>PE-P142LL-27478 Coax, 50 Ohm</b>						
Part No. <b>PE3M0130</b>	Cable Dia.	Attn. @ 1 GHz	Power @ 1 GHz			
1 piece price shown. See web or call for volume pricing.	0.195" dia.	dB/100ft	W			
12" 18" 24" 36"	48" 60"	Custom Len.				
\$446.13 \$454.60 \$463.08 \$480.04	\$497.00 \$513.95	See Web				
<b>PE-P160LL-27478 Coax, 50 Ohm</b>						
Part No. <b>PE3M0184</b>	Cable Dia.	Attn. @ 1 GHz	Power @ 1 GHz			
1 piece price shown. See web or call for volume pricing.	0.160" dia.	dB/100ft	W			
8" 12" 18" 24"	30" 36"	Custom Len.				
\$434.75 \$439.65 \$447.00 \$454.35	\$461.70 \$469.06	See Web				
<b>PE-P160LL Coax, 50 Ohm</b>						
Part No. <b>PE3C5260</b>	Cable Dia.	Attn. @ 1 GHz	Power @ 1 GHz			
1 piece price shown. See web or call for volume pricing.	0.160" dia.	dB/100ft	W			
12" 24" 36" 48"	60" 50CM	Custom Len.				
\$231.73 \$252.45 \$273.15 \$293.87	\$314.58 \$245.00	See Web				
<b>Standard Formable Cable Assemblies</b>						
<b>PE-SR402FL Coax, 50 Ohm</b>						
Part No. <b>PE39483</b>	Cable Dia.	Attn. @ 1 GHz	Power @ 1 GHz			
1 piece price shown. See web or call for volume pricing.	" dia.	12 dB/100ft	400 W			
6" 9" 12" 18"	24" -	Custom Len.				
\$48.25 \$45.52 \$48.25 \$52.43	\$56.60 -	See Web				
<b>PE-SR402FLJ Coax, 50 Ohm</b>						
Part No. <b>PE39497</b>	Cable Dia.	Attn. @ 1 GHz	Power @ 1 GHz			
1 piece price shown. See web or call for volume pricing.	0.161" dia.	12 dB/100ft	303 W			
6" 9" 12" 18"	24" -	Custom Len.				
\$54.74 \$51.64 \$54.74 \$59.23	\$63.72 -	See Web				
<b>Standard Flexible Cable Assemblies</b>						
<b>RG316/U Coax, 50 Ohm</b>						
Part No. <b>PE3W05224</b>	Cable Dia.	Attn. @ 1 GHz	Power @ 1 GHz			
1 piece price shown. See web or call for volume pricing.	0.098" dia.	58 dB/100ft	160 W			
12" 24" 36" 48"	60" 50CM	Custom Len.				
\$54.19 \$57.47 \$60.75 \$64.03	\$67.32 \$56.29	See Web				
<b>SMA MALE TO REVERSE POLARITY TNC MALE</b>						
<b>Low Loss Flexible Cable Assemblies</b>						
<b>PE-C195 Coax, 50 Ohm</b>						
Part No. <b>PE37120</b>	Cable Dia.	Attn. @ 1 GHz	Power @ 1 GHz			
1 piece price shown. See web or call for volume pricing.	0.195" dia.	11 dB/100ft	150 W			
12" 24" 36" 48"	60" -	Custom Len.				
\$43.24 \$40.02 \$40.74 \$41.45	\$46.43 -	See Web				
<b>Standard Flexible Cable Assemblies</b>						
<b>RG58C/U Coax, 50 Ohm</b>						
Part No. <b>PE34853</b>	Cable Dia.	Attn. @ 1 GHz	Power @ 1 GHz			
1 piece price shown. See web or call for volume pricing.	0.195" dia.	20 dB/100ft	44 W			
12" 24" 36" 48"	60" 72"	Custom Len.				
\$45.91 \$46.64 \$47.38 \$48.12	\$48.85 \$49.59	See Web				
<b>RG142B/U Coax, 50 Ohm</b>						

Cable Assemblies

See Our Website For Current Pricing & Real-Time Stock Availability!

Continued on Next Page

For Custom Lengths, Metric Lengths or Special Configurations, Please call (949) 261-1920



Technical Support  
+1 (949) 261-1920



Same-Day Shipping,  
Even Custom Cable Assemblies

For our complete selection of cable assemblies, please visit our website

Part No.	Cable Dia.	Attn. @ 1 GHz	Power @ 1 GHz
<b>PE34854</b>	0.195" dia.	13 dB/100ft	650 W
1 piece price shown. See web or call for volume pricing.			
12"	24"	36"	48"
\$46.89	\$56.72	\$62.80	\$64.09
RG223/U Coax, 50 Ohm			
<b>PE34397</b>	0.210" dia.	13 dB/100ft	53 W
1 piece price shown. See web or call for volume pricing.			
12"	24"	36"	48"
\$43.99	\$46.89	\$49.79	\$52.69
RG316/U Coax, 50 Ohm			
<b>PE34396</b>	0.098" dia.	38 dB/100ft	160 W
1 piece price shown. See web or call for volume pricing.			
12"	24"	36"	48"
\$53.44	\$60.83	\$63.96	\$62.43
SMA MALE TO HMCX32 1.2 PLUG			
Standard Flexible Cable Assemblies			
PE-81mm Coax, 50 Ohm			
<b>PE3CA1030</b>	0.032" dia.	dB/100ft	W
1 piece price shown. See web or call for volume pricing.			
3"	6"	12"	-
\$11.21	\$12.93	\$12.93	-
SMA MALE TO UMCX PLUG			
Standard Flexible Cable Assemblies			
RG178B/U Coax, 50 Ohm			
<b>PE38881</b>	0.072" dia.	dB/100ft	W
1 piece price shown. See web or call for volume pricing.			
3"	6"	9"	12"
\$65.24	\$66.95	\$68.67	\$70.38
SMA MALE TO UMCX 2.1 PLUG			
Standard Flexible Cable Assemblies			
PE-81mm Coax, 50 Ohm			
<b>PE3CA1028</b>	0.032" dia.	dB/100ft	W
1 piece price shown. See web or call for volume pricing.			
3"	6"	12"	-
\$12.93	\$14.57	\$12.93	-
SMA MALE TO UMCX 2.5 PLUG			
Standard Flexible Cable Assemblies			
RG178B/U Coax, 50 Ohm			
<b>PE3CA1026</b>	0.070" dia.	dB/100ft	W
1 piece price shown. See web or call for volume pricing.			
6"	9"	12"	-
\$11.21	\$12.93	\$12.93	-
RG178-DS Coax, 50 Ohm			
<b>PE3CA1027</b>	0.086" dia.	dB/100ft	W
1 piece price shown. See web or call for volume pricing.			
3"	6"	9"	12"
\$11.21	\$14.05	\$11.21	\$14.05
PE-81mm Coax, 50 Ohm			
<b>PE3CA1023</b>	0.032" dia.	dB/100ft	W
1 piece price shown. See web or call for volume pricing.			
3"	6"	12"	-
\$12.93	\$11.21	\$14.57	-
PE-113mm Coax, 50 Ohm			
<b>PE3CA1024</b>	0.044" dia.	dB/100ft	W
1 piece price shown. See web or call for volume pricing.			
3"	6"	12"	18"
\$12.93	\$12.93	\$12.93	\$12.25
PE-137mm Coax, 50 Ohm			
<b>PE3CA1025</b>	0.053" dia.	dB/100ft	W
1 piece price shown. See web or call for volume pricing.			
3"	6"	12"	-
\$14.57	\$12.93	\$12.93	-
SMA MALE TO WMCX 1.6 PLUG			
Standard Flexible Cable Assemblies			
PE-81mm Coax, 50 Ohm			

Part No.	Cable Dia.	Attn. @ 1 GHz	Power @ 1 GHz
<b>PE3CA1029</b>	0.032" dia.	dB/100ft	W
1 piece price shown. See web or call for volume pricing.			
3"	6"	12"	-
\$12.93	\$12.93	\$12.93	-
REVERSE POLARITY SMA MALE TO BNC MALE			
Standard Flexible Cable Assemblies			
RG58C/U Coax, 50 Ohm			
<b>PE35207</b>	0.195" dia.	20 dB/100ft	44 W
1 piece price shown. See web or call for volume pricing.			
12"	24"	36"	48"
\$50.45	\$55.31	\$56.12	\$52.67
RG142B/U Coax, 50 Ohm			
<b>PE35209</b>	0.195" dia.	13 dB/100ft	650 W
1 piece price shown. See web or call for volume pricing.			
12"	24"	36"	48"
\$46.37	\$52.11	\$57.84	\$68.67
RG174A/U Coax, 50 Ohm			
<b>PE3C3332</b>	0.110" dia.	32 dB/100ft	17 W
1 piece price shown. See web or call for volume pricing.			
12"	24"	36"	48"
\$43.05	\$47.93	\$43.86	\$44.32
RG178B/U Coax, 50 Ohm			
<b>PE35213</b>	0.072" dia.	44 dB/100ft	78 W
1 piece price shown. See web or call for volume pricing.			
12"	24"	36"	48"
\$68.74	\$69.71	\$70.65	\$71.62
RG188A/U Coax, 50 Ohm			
<b>PE3C3412</b>	0.110" dia.	26 dB/100ft	160 W
1 piece price shown. See web or call for volume pricing.			
12"	24"	36"	48"
\$44.68	\$46.69	\$48.77	\$50.85
RG223/U Coax, 50 Ohm			
<b>PE35217</b>	0.210" dia.	13 dB/100ft	53 W
1 piece price shown. See web or call for volume pricing.			
12"	24"	36"	48"
\$46.12	\$46.42	\$52.36	\$52.22
RG316/U Coax, 50 Ohm			
<b>PE3C3413</b>	0.102" dia.	38 dB/100ft	160 W
1 piece price shown. See web or call for volume pricing.			
12"	24"	36"	48"
\$45.48	\$53.14	\$56.27	\$54.13
REVERSE POLARITY SMA MALE TO MCX PLUG RIGHT ANGLE			
Standard Flexible Cable Assemblies			
RG316/U Coax, 50 Ohm			
<b>PE3C0481</b>	0.098" dia.	38 dB/100ft	160 W
1 piece price shown. See web or call for volume pricing.			
12"	24"	36"	48"
\$58.03	\$61.16	\$60.52	\$63.40
REVERSE POLARITY SMA MALE TO N MALE			
Low Loss Flexible Cable Assemblies			
PE-C195 Coax, 50 Ohm			
<b>PE36072</b>	0.195" dia.	11 dB/100ft	150 W
1 piece price shown. See web or call for volume pricing.			
12"	24"	36"	48"
\$48.51	\$49.22	\$49.93	\$50.65
Standard Flexible Cable Assemblies			
RG58C/U Coax, 50 Ohm			
<b>PE34727</b>	0.195" dia.	20 dB/100ft	44 W
1 piece price shown. See web or call for volume pricing.			
12"	24"	36"	48"
\$54.09	\$54.83	\$60.04	\$56.30
RG142B/U Coax, 50 Ohm			
<b>PE34361</b>	0.195" dia.	13 dB/100ft	650 W
1 piece price shown. See web or call for volume pricing.			
12"	24"	36"	48"
\$57.23	\$59.71	\$69.38	\$75.82
RG174A/U Coax, 50 Ohm			
<b>PE35221</b>	0.100" dia.	32 dB/100ft	16 W
1 piece price shown. See web or call for volume pricing.			
12"	24"	36"	48"
\$55.44	\$60.46	\$56.31	\$56.75
RG178B/U Coax, 50 Ohm			

Cable Assemblies See Our Website For Current Pricing & Real-Time Stock Availability!

\*Coax Performance at 1 GHz Notes: Cable assembly max frequency may be lower than connector or coax max frequency

For our complete selection of cable assemblies, please visit our website

<b>Part No. PE35223</b>				Cable Dia.	Attn. @ 1 GHz	Power @ 1 GHz	78
1 piece price shown. See web or call for volume pricing.				0.072" dia.	44 dB/100ft	78 W	
12"	24"	36"	48"	60"	72"	Custom Len.	
\$73.72	\$79.20	\$75.65	\$76.61	\$77.56	\$78.52	See Web	

<b>Part No. PE35225</b>				Cable Dia.	Attn. @ 1 GHz	Power @ 1 GHz	79
1 piece price shown. See web or call for volume pricing.				0.110" dia.	26 dB/100ft	160 W	
12"	24"	36"	48"	60"	72"	Custom Len.	
\$60.68	\$59.45	\$61.68	\$63.89	\$66.11	\$68.34	See Web	

<b>Part No. PE35227</b>				Cable Dia.	Attn. @ 1 GHz	Power @ 1 GHz	80
1 piece price shown. See web or call for volume pricing.				0.210" dia.	13 dB/100ft	53 W	
12"	24"	36"	48"	60"	72"	Custom Len.	
\$51.17	\$54.07	\$56.98	\$63.76	\$66.94	\$65.66	See Web	

<b>Part No. PE34770</b>				Cable Dia.	Attn. @ 1 GHz	Power @ 1 GHz	81
1 piece price shown. See web or call for volume pricing.				0.098" dia.	38 dB/100ft	160 W	
12"	24"	36"	48"	60"	72"	Custom Len.	
\$61.60	\$61.00	\$63.89	\$66.79	\$69.66	\$72.55	See Web	

<b>Part No. PE34323</b>				Cable Dia.	Attn. @ 1 GHz	Power @ 1 GHz	82
1 piece price shown. See web or call for volume pricing.				0.195" dia.	15 dB/100ft	650 W	
12"	24"	36"	48"	60"	-	Custom Len.	
\$61.33	\$64.83	\$76.13	\$78.77	\$91.48	-	See Web	

<b>Part No. PE35508</b>				Cable Dia.	Attn. @ 1 GHz	Power @ 1 GHz	83
1 piece price shown. See web or call for volume pricing.				0.195" dia.	13 dB/100ft	650 W	
12"	24"	36"	48"	60"	-	Custom Len.	
\$62.05	\$70.91	\$79.76	\$88.61	\$97.47	-	See Web	

**REVERSE POLARITY SMA MALE TO N FEMALE BULKHEAD**

SEE MOUNTING HOLE SECTION ON PAGE 369



**Standard Flexible Cable Assemblies**

<b>Part No. PE3W02336</b>				Cable Dia.	Attn. @ 1 GHz	Power @ 1 GHz	84
1 piece price shown. See web or call for volume pricing.				0.195" dia.	20 dB/100ft	80 W	
12"	24"	36"	48"	60"	50CM	Custom Len.	
\$56.18	\$56.96	\$57.74	\$58.53	\$59.31	\$56.68	See Web	

<b>Part No. PE34575</b>				Cable Dia.	Attn. @ 1 GHz	Power @ 1 GHz	85
1 piece price shown. See web or call for volume pricing.				0.195" dia.	13 dB/100ft	650 W	
12"	24"	36"	48"	60"	-	Custom Len.	
\$58.37	\$64.10	\$69.82	\$75.57	\$81.29	-	See Web	

**REVERSE POLARITY SMA MALE TO REVERSE POLARITY SMA MALE**



**Standard Flexible Cable Assemblies**

<b>Part No. PE34750</b>				Cable Dia.	Attn. @ 1 GHz	Power @ 1 GHz	86
1 piece price shown. See web or call for volume pricing.				0.195" dia.	13 dB/100ft	650 W	
12"	18"	24"	36"	48"	60"	Custom Len.	
\$55.66	\$58.70	\$61.74	\$67.82	\$69.20	\$74.77	See Web	

**REVERSE POLARITY SMA MALE TO TNC MALE**



**Standard Flexible Cable Assemblies**

<b>Part No. PE35214</b>				Cable Dia.	Attn. @ 1 GHz	Power @ 1 GHz	87
1 piece price shown. See web or call for volume pricing.				0.195" dia.	20 dB/100ft	44 W	
12"	24"	36"	48"	60"	72"	Custom Len.	
\$55.12	\$55.93	\$52.51	\$53.25	\$53.99	\$54.72	See Web	

<b>Part No. PE35216</b>				Cable Dia.	Attn. @ 1 GHz	Power @ 1 GHz	88
1 piece price shown. See web or call for volume pricing.				0.195" dia.	13 dB/100ft	650 W	
12"	24"	36"	48"	60"	72"	Custom Len.	
\$52.58	\$58.33	\$64.05	\$69.79	\$75.51	\$81.25	See Web	

<b>Part No. PE35220</b>				Cable Dia.	Attn. @ 1 GHz	Power @ 1 GHz	89
1 piece price shown. See web or call for volume pricing.				0.072" dia.	44 dB/100ft	78 W	
12"	24"	36"	48"	60"	72"	Custom Len.	
\$71.20	\$79.38	\$73.12	\$74.07	\$75.05	\$76.00	See Web	

<b>Part No. PE35226</b>				Cable Dia.	Attn. @ 1 GHz	Power @ 1 GHz	90
1 piece price shown. See web or call for volume pricing.				0.098" dia.	38 dB/100ft	160 W	
12"	24"	36"	48"	60"	72"	Custom Len.	
\$62.51	\$65.39	\$68.28	\$71.17	\$79.00	\$76.95	See Web	

**REVERSE THREAD SMA MALE TO REVERSE THREAD SMA MALE**



**Standard Flexible Cable Assemblies**

<b>Part No. PE35349</b>				Cable Dia.	Attn. @ 1 GHz	Power @ 1 GHz	91
1 piece price shown. See web or call for volume pricing.				0.195" dia.	20 dB/100ft	44 W	
12"	24"	36"	48"	60"	72"	Custom Len.	
\$61.54	\$62.32	\$63.04	\$63.76	\$64.48	\$65.21	See Web	

<b>Part No. PE35353</b>				Cable Dia.	Attn. @ 1 GHz	Power @ 1 GHz	92
1 piece price shown. See web or call for volume pricing.				0.195" dia.	13 dB/100ft	650 W	
12"	24"	36"	48"	60"	72"	Custom Len.	
\$64.42	\$69.94	\$75.51	\$81.04	\$86.57	\$92.15	See Web	

<b>Part No. PE35357</b>				Cable Dia.	Attn. @ 1 GHz	Power @ 1 GHz	93
1 piece price shown. See web or call for volume pricing.				0.100" dia.	32 dB/100ft	16 W	
12"	24"	36"	48"	60"	72"	Custom Len.	
\$69.24	\$69.69	\$70.11	\$70.55	\$70.98	\$71.42	See Web	

<b>Part No. PE35361</b>				Cable Dia.	Attn. @ 1 GHz	Power @ 1 GHz	94
1 piece price shown. See web or call for volume pricing.				0.072" dia.	44 dB/100ft	78 W	
12"	24"	36"	48"	60"	72"	Custom Len.	
\$65.80	\$66.76	\$67.71	\$68.69	\$69.64	\$77.78	See Web	

<b>Part No. PE35369</b>				Cable Dia.	Attn. @ 1 GHz	Power @ 1 GHz	95
1 piece price shown. See web or call for volume pricing.				0.210" dia.	13 dB/100ft	53 W	
12"	24"	36"	48"	60"	72"	Custom Len.	
\$66.73	\$69.64	\$72.54	\$75.43	\$78.33	\$81.24	See Web	

<b>Part No. PE35373</b>				Cable Dia.	Attn. @ 1 GHz	Power @ 1 GHz	96
1 piece price shown. See web or call for volume pricing.				0.098" dia.	38 dB/100ft	160 W	
12"	24"	36"	48"	60"	72"	Custom Len.	
\$67.85	\$70.84	\$73.84	\$76.84	\$79.84	\$82.85	See Web	

**SMA MALE RIGHT ANGLE TO SMA MALE RIGHT ANGLE**



**Standard Flexible Cable Assemblies**

<b>Part No. PE3M0025</b>				Cable Dia.	Attn. @ 1 GHz	Power @ 1 GHz	97
1 piece price shown. See web or call for volume pricing.				0.195" dia.	dB/100ft	W	
12"	18"	24"	30"	36"	48"	Custom Len.	
\$286.19	\$288.91	\$291.65	\$294.37	\$297.10	\$302.56	See Web	

<b>Part No. PE3M0053</b>				Cable Dia.	Attn. @ 1 GHz	Power @ 1 GHz	98
1 piece price shown. See web or call for volume pricing.				0.212" dia.	dB/100ft	W	
12"	18"	24"	30"	36"	48"	Custom Len.	
\$290.49	\$295.37	\$300.25	\$305.12	\$310.01	\$319.76	See Web	

<b>Part No. PE3M0081</b>				Cable Dia.	Attn. @ 1 GHz	Power @ 1 GHz	99
1 piece price shown. See web or call for volume pricing.				0.195" dia.	dB/100ft	W	
12"	18"	24"	30"	36"	48"	Custom Len.	
\$287.68	\$291.14	\$294.62	\$298.08	\$301.56	\$308.50	See Web	

<b>Part No. PE3M0093</b>				Cable Dia.	Attn. @ 1 GHz	Power @ 1 GHz	1
1 piece price shown. See web or call for volume pricing.				0.098" dia.	dB/100ft	W	
6"	8"	12"	16"	18"	24"	Custom Len.	
\$204.89	\$205.22	\$205.90	\$206.55	\$206.90	\$207.90	See Web	

<b>Part No. PE3M0108</b>				Cable Dia.	Attn. @ 1 GHz	Power @ 1 GHz	2
1 piece price shown. See web or call for volume pricing.				0.110" dia.	dB/100ft	W	
6"	8"	12"	16"	18"	24"	Custom Len.	
\$204.28	\$204.40	\$204.67	\$204.92	\$205.06	\$205.45	See Web	

<b>Part No. PE3M0121</b>				Cable Dia.	Attn. @ 1 GHz	Power @ 1 GHz	3
1 piece price shown. See web or call for volume pricing.				0.195" dia.	dB/100ft	W	
12"	18"	24"	30"	36"	48"	Custom Len.	
\$201.78	\$202.37	\$202.98	\$203.56	\$204.17	\$205.37	See Web	

**SMA MALE RIGHT ANGLE TO SMA FEMALE BULKHEAD**

SEE MOUNTING HOLE SECTION ON PAGE 369



**Standard Flexible Cable Assemblies**

<b>Part No. PE3M0094</b>				Cable Dia.	Attn. @ 1 GHz	Power @ 1 GHz	4
1 piece price shown. See web or call for volume pricing.				0.098" dia.	dB/100ft	W	
6"	8"	12"	16"	18"	24"	Custom Len.	
\$195.65	\$195.98	\$196.65	\$197.32	\$197.66	\$198.66	See Web	

Cable Assemblies

See Our Website For Current Pricing & Real-Time Stock Availability!

Continued on Next Page

For Custom Lengths, Metric Lengths or Special Configurations, Please call (949) 261-1920



Technical Support  
+1 (949) 261-1920



Same-Day Shipping,  
Even Custom Cable Assemblies

For our complete selection of cable assemblies, please visit our website

Part No.	Cable Dia.	Attn. @ 1 GHz	Power @ 1 GHz
<b>PE3M0109</b>	0.110" dia.	dB/100ft	W
1 piece price shown. See web or call for volume pricing.			
6"	8"	12"	16"
\$195.04	\$195.17	\$195.43	\$195.69
\$195.82	\$196.20	See Web	
<b>SMA MALE RIGHT ANGLE TO TNC MALE</b>			
<b>Standard Flexible Cable Assemblies</b>			
<b>M17/60-RG142-27478 Coax, 50 Ohm</b>			
<b>PE3M0027</b>	0.195" dia.	dB/100ft	W
1 piece price shown. See web or call for volume pricing.			
12"	18"	24"	30"
\$223.99	\$226.71	\$229.44	\$232.16
\$234.90	\$240.35	See Web	
<b>M17/84-RG223-0XDS2 Coax, 50 Ohm</b>			
<b>PE3M0055</b>	0.212" dia.	dB/100ft	W
1 piece price shown. See web or call for volume pricing.			
12"	18"	24"	30"
\$228.29	\$233.16	\$238.05	\$242.92
\$247.80	\$257.56	See Web	
<b>M17/128-RG400-27478 Coax, 50 Ohm</b>			
<b>PE3M0083</b>	0.195" dia.	dB/100ft	W
1 piece price shown. See web or call for volume pricing.			
12"	18"	24"	30"
\$225.47	\$228.93	\$232.41	\$235.89
\$239.35	\$246.29	See Web	
<b>M17/113-RG316-27478 Coax, 50 Ohm</b>			
<b>PE3M0097</b>	0.098" dia.	dB/100ft	W
1 piece price shown. See web or call for volume pricing.			
6"	8"	12"	16"
\$196.61	\$196.94	\$197.62	\$198.27
\$198.62	\$199.62	See Web	
<b>M17/119-RG174-0XDS2 Coax, 50 Ohm</b>			
<b>PE3M0112</b>	0.110" dia.	dB/100ft	W
1 piece price shown. See web or call for volume pricing.			
6"	8"	12"	16"
\$196.00	\$196.12	\$196.39	\$196.64
\$196.78	\$197.17	See Web	
<b>M17/28-RG058-0XDS2 Coax, 50 Ohm</b>			
<b>PE3M0123</b>	0.195" dia.	dB/100ft	W
1 piece price shown. See web or call for volume pricing.			
12"	18"	24"	30"
\$230.86	\$231.45	\$232.05	\$232.64
\$233.25	\$234.44	See Web	
<b>SMA MALE RIGHT ANGLE TO BNC MALE</b>			
<b>Low Loss Flexible Cable Assemblies</b>			
<b>PE-C195 Coax, 50 Ohm</b>			
<b>PE38093</b>	0.195" dia.	11 dB/100ft	150 W
1 piece price shown. See web or call for volume pricing.			
12"	24"	36"	48"
\$45.50	\$42.08	\$42.79	\$43.49
\$48.69	See Web		
<b>Standard Flexible Cable Assemblies</b>			
<b>RG58C/U Coax, 50 Ohm</b>			
<b>PE3850</b>	0.195" dia.	20 dB/100ft	44 W
1 piece price shown. See web or call for volume pricing.			
6"	12"	18"	24"
\$52.55	\$52.55	\$52.93	\$58.62
\$59.43	\$54.77	See Web	
<b>RG142B/U Coax, 50 Ohm</b>			
<b>PE3780</b>	0.195" dia.	13 dB/100ft	650 W
1 piece price shown. See web or call for volume pricing.			
6"	12"	18"	24"
\$45.37	\$45.59	\$48.46	\$51.34
\$57.06	\$62.80	See Web	
<b>RG174A/U Coax, 50 Ohm</b>			
<b>PE3C3448</b>	0.110" dia.	32 dB/100ft	17 W
1 piece price shown. See web or call for volume pricing.			
6"	12"	18"	24"
\$51.76	\$52.04	\$52.32	\$52.61
\$53.20	\$53.04	See Web	
<b>RG178B/U Coax, 50 Ohm</b>			
<b>PE33257</b>	0.072" dia.	44 dB/100ft	78 W
1 piece price shown. See web or call for volume pricing.			
12"	24"	36"	48"
\$83.44	\$84.50	\$85.56	\$86.67
\$87.75	See Web		
<b>RG188A/U Coax, 50 Ohm</b>			
<b>PE3C3437</b>	0.110" dia.	26 dB/100ft	160 W
1 piece price shown. See web or call for volume pricing.			
6"	12"	18"	24"
\$51.79	\$55.94	\$52.91	\$54.02
\$60.93	\$63.57	See Web	
<b>RG223/U Coax, 50 Ohm</b>			
<b>PE3733</b>	0.210" dia.	13 dB/100ft	53 W
1 piece price shown. See web or call for volume pricing.			
6"	12"	18"	24"
\$59.91	\$61.42	\$57.29	\$64.53
\$67.65	\$70.94	See Web	
<b>RG303/U Coax, 50 Ohm</b>			

Part No.	Cable Dia.	Attn. @ 1 GHz	Power @ 1 GHz
<b>PE39138</b>	0.170" dia.	14 dB/100ft	650 W
1 piece price shown. See web or call for volume pricing.			
12"	24"	36"	48"
\$42.93	\$51.08	\$54.40	\$60.13
\$65.86	See Web		
<b>RG316/U Coax, 50 Ohm</b>			
<b>PE3C3350</b>	0.102" dia.	38 dB/100ft	160 W
1 piece price shown. See web or call for volume pricing.			
6"	12"	18"	24"
\$54.76	\$59.14	\$56.19	\$62.26
\$65.38	\$68.69	See Web	
<b>RG400/U Coax, 50 Ohm</b>			
<b>PE3642</b>	0.195" dia.	15 dB/100ft	650 W
1 piece price shown. See web or call for volume pricing.			
6"	12"	18"	24"
\$60.18	\$62.59	\$63.66	\$67.15
\$74.12	\$81.08	See Web	
<b>PE-P195 Coax, 50 Ohm</b>			
<b>PE33889</b>	0.195" dia.	13 dB/100ft	650 W
1 piece price shown. See web or call for volume pricing.			
12"	24"	36"	48"
\$51.76	\$60.62	\$69.47	\$78.32
\$93.93	See Web		
<b>SMA MALE RIGHT ANGLE TO BNC FEMALE BULKHEAD</b>			
SEE MOUNTING HOLE SECTION ON PAGE 369			
<b>Standard Flexible Cable Assemblies</b>			
<b>RG316/U Coax, 50 Ohm</b>			
<b>PE3681</b>	0.098" dia.	38 dB/100ft	160 W
1 piece price shown. See web or call for volume pricing.			
12"	24"	36"	48"
\$66.04	\$69.17	\$68.09	\$75.60
\$73.85	See Web		
<b>RG400/U Coax, 50 Ohm</b>			
<b>PE34957</b>	0.195" dia.	15 dB/100ft	650 W
1 piece price shown. See web or call for volume pricing.			
12"	24"	36"	48"
\$76.49	\$77.80	\$84.76	\$91.73
\$98.71	See Web		
<b>SMA MALE RIGHT ANGLE TO MCX PLUG RIGHT ANGLE</b>			
<b>Standard Semi-Rigid Cable Assemblies</b>			
<b>PE-SR405AL Coax, 50 Ohm</b>			
<b>PE3W02882</b>	" dia.	50CM	Custom Len.
1 piece price shown. See web or call for volume pricing.			
12"	24"	36"	48"
\$53.80	\$63.04	\$72.27	\$81.51
\$90.75	\$59.72	See Web	
<b>SMA MALE RIGHT ANGLE TO MCX JACK</b>			
<b>Standard Flexible Cable Assemblies</b>			
<b>RG316/U Coax, 50 Ohm</b>			
<b>PE3W02744</b>	0.102" dia.	38 dB/100ft	160 W
1 piece price shown. See web or call for volume pricing.			
12"	24"	36"	48"
\$65.83	\$68.86	\$71.89	\$74.92
\$77.96	\$67.76	See Web	
<b>RG316-DS Coax, 50 Ohm</b>			
<b>PE3W01114</b>	0.114" dia.	50CM	Custom Len.
1 piece price shown. See web or call for volume pricing.			
12"	24"	36"	48"
\$58.27	\$61.30	\$64.33	\$67.37
\$70.40	\$60.21	See Web	
<b>SMA MALE RIGHT ANGLE TO MMCX PLUG RIGHT ANGLE</b>			
<b>Standard Flexible Cable Assemblies</b>			
<b>RG174A/U Coax, 50 Ohm</b>			
<b>PE36507</b>	0.100" dia.	32 dB/100ft	16 W
1 piece price shown. See web or call for volume pricing.			
12"	24"	36"	48"
\$66.94	\$67.51	\$68.10	\$68.71
\$62.58	See Web		
<b>SMA MALE RIGHT ANGLE TO N MALE</b>			
<b>Low Loss Flexible Cable Assemblies</b>			
<b>PE-P142LL-27478 Coax, 50 Ohm</b>			
<b>PE3M0156</b>	0.195" dia.	dB/100ft	W
1 piece price shown. See web or call for volume pricing.			
12"	18"	24"	36"
\$459.11	\$467.59	\$476.07	\$493.03
\$509.98	\$526.94	See Web	

Cable Assemblies  
See Our Website For Current Pricing & Real-Time Stock Availability!

\*Coax Performance at 1 GHz Notes: Cable assembly max frequency may be lower than connector or coax max frequency

# For our complete selection of cable assemblies, please visit our website

PE-P160LL-27478 Coax, 50 Ohm						
Part No. <b>PE3M0201</b>	Cable Dia.		Attn. @ 1 GHz	Power @ 1 GHz		
1 piece price shown. See web or call for volume pricing.						
8"	12"	18"	24"	30"	36"	Custom Len.
\$446.55	\$451.46	\$458.81	\$466.16	\$473.51	\$480.86	See Web
PE-P300LL-27478 Coax, 50 Ohm						
Part No. <b>PE3M0235</b>	Cable Dia.		Attn. @ 1 GHz	Power @ 1 GHz		
1 piece price shown. See web or call for volume pricing.						
12"	18"	24"	36"	48"	60"	Custom Len.
\$530.27	\$544.43	\$558.58	\$586.88	\$615.18	\$643.48	See Web
Low Loss Test Flexible Cable Assemblies						
PE-P300LL Coax, 50 Ohm						
Part No. <b>PE3C3238</b>	Cable Dia.		Attn. @ 1 GHz	Power @ 1 GHz		
1 piece price shown. See web or call for volume pricing.						
12"	24"	36"	48"	60"	50CM	Custom Len.
\$249.68	\$274.87	\$300.04	\$325.23	\$350.41	\$265.83	See Web
Standard Flexible Cable Assemblies						
RG142B/U Coax, 50 Ohm						
Part No. <b>PE3W00921</b>	Cable Dia.		Attn. @ 1 GHz	Power @ 1 GHz		
1 piece price shown. See web or call for volume pricing.						
12"	24"	36"	48"	60"	50CM	Custom Len.
\$52.74	\$58.64	\$64.54	\$70.44	\$76.35	\$56.52	See Web
SMA MALE RIGHT ANGLE TO N MALE RIGHT ANGLE						
Flexible Cable Assemblies						
LMR-195-FR Coax, 50 Ohm						
Part No. <b>PE3W05298</b>	Cable Dia.		Attn. @ 1 GHz	Power @ 1 GHz		
1 piece price shown. See web or call for volume pricing.						
12"	24"	36"	48"	60"	50CM	Custom Len.
\$54.57	\$55.57	\$56.56	\$57.56	\$58.56	\$55.20	See Web
Low Loss Flexible Cable Assemblies						
LMR-195 Coax, 50 Ohm						
Part No. <b>PE3W00852</b>	Cable Dia.		Attn. @ 1 GHz	Power @ 1 GHz		
1 piece price shown. See web or call for volume pricing.						
12"	24"	36"	48"	60"	50CM	Custom Len.
\$52.83	\$53.56	\$54.29	\$55.02	\$55.74	\$53.29	See Web
PE-P142LL Coax, 50 Ohm						
Part No. <b>PE3C1528</b>	Cable Dia.		Attn. @ 1 GHz	Power @ 1 GHz		
1 piece price shown. See web or call for volume pricing.						
12"	24"	36"	48"	60"	50CM	Custom Len.
\$304.33	\$320.56	\$336.80	\$353.04	\$369.27	\$314.73	See Web
PE-P142LL-27478 Coax, 50 Ohm						
Part No. <b>PE3M0158</b>	Cable Dia.		Attn. @ 1 GHz	Power @ 1 GHz		
1 piece price shown. See web or call for volume pricing.						
12"	18"	24"	36"	48"	60"	Custom Len.
\$574.14	\$582.62	\$591.10	\$608.05	\$625.01	\$641.97	See Web
PE-P160LL-27478 Coax, 50 Ohm						
Part No. <b>PE3M0203</b>	Cable Dia.		Attn. @ 1 GHz	Power @ 1 GHz		
1 piece price shown. See web or call for volume pricing.						
8"	12"	18"	24"	30"	36"	Custom Len.
\$544.61	\$549.52	\$556.86	\$564.22	\$571.56	\$578.92	See Web
PE-P300LL-27478 Coax, 50 Ohm						
Part No. <b>PE3M0237</b>	Cable Dia.		Attn. @ 1 GHz	Power @ 1 GHz		
1 piece price shown. See web or call for volume pricing.						
12"	18"	24"	36"	48"	60"	Custom Len.
\$675.21	\$689.37	\$693.13	\$731.82	\$763.24	\$788.42	See Web
Low Loss Test Flexible Cable Assemblies						
PE-P300LL Coax, 50 Ohm						
Part No. <b>PE3C3249</b>	Cable Dia.		Attn. @ 1 GHz	Power @ 1 GHz		
1 piece price shown. See web or call for volume pricing.						
12"	24"	36"	48"	60"	50CM	Custom Len.
\$451.55	\$476.76	\$501.96	\$527.17	\$552.36	\$467.70	See Web
SMA MALE RIGHT ANGLE TO N FEMALE BULKHEAD						
SEE MOUNTING HOLE SECTION ON PAGE 369						
Precision Formable Cable Assemblies						
PE-SR402FL Coax, 50 Ohm						
Part No. <b>PE39456</b>	Cable Dia.		Attn. @ 1 GHz	Power @ 1 GHz		
1 piece price shown. See web or call for volume pricing.						
6"	9"	12"	18"	24"	-	Custom Len.
\$54.05	\$50.04	\$54.05	\$58.23	\$62.40	-	See Web
PE-SR402FLJ Coax, 50 Ohm						
Part No. <b>PE39470</b>	Cable Dia.		Attn. @ 1 GHz	Power @ 1 GHz		
1 piece price shown. See web or call for volume pricing.						
6"	9"	12"	18"	24"	-	Custom Len.
\$55.41	\$52.27	\$55.41	\$59.90	\$64.39	-	See Web
Low Loss Flexible Cable Assemblies						

PE-P142LL Coax, 50 Ohm						
Part No. <b>PE3C2985</b>	Cable Dia.		Attn. @ 1 GHz	Power @ 1 GHz		
1 piece price shown. See web or call for volume pricing.						
12"	24"	36"	48"	60"	50CM	Custom Len.
\$258.08	\$274.31	\$290.55	\$306.79	\$323.01	\$268.48	See Web
PE-P142LL-27478 Coax, 50 Ohm						
Part No. <b>PE3M0157</b>	Cable Dia.		Attn. @ 1 GHz	Power @ 1 GHz		
1 piece price shown. See web or call for volume pricing.						
12"	18"	24"	36"	48"	60"	Custom Len.
\$546.32	\$554.79	\$563.27	\$580.23	\$597.19	\$614.14	See Web
PE-P160LL-27478 Coax, 50 Ohm						
Part No. <b>PE3M0202</b>	Cable Dia.		Attn. @ 1 GHz	Power @ 1 GHz		
1 piece price shown. See web or call for volume pricing.						
8"	12"	18"	24"	30"	36"	Custom Len.
\$548.55	\$553.44	\$560.80	\$568.15	\$575.50	\$582.85	See Web
PE-P300LL-27478 Coax, 50 Ohm						
Part No. <b>PE3M0236</b>	Cable Dia.		Attn. @ 1 GHz	Power @ 1 GHz		
1 piece price shown. See web or call for volume pricing.						
12"	18"	24"	36"	48"	60"	Custom Len.
\$605.94	\$620.10	\$634.25	\$662.55	\$690.85	\$719.15	See Web
Low Loss Test Flexible Cable Assemblies						
PE-P300LL Coax, 50 Ohm						
Part No. <b>PE3C3245</b>	Cable Dia.		Attn. @ 1 GHz	Power @ 1 GHz		
1 piece price shown. See web or call for volume pricing.						
12"	24"	36"	48"	60"	50CM	Custom Len.
\$417.12	\$442.31	\$467.52	\$492.72	\$517.93	\$433.25	See Web
Standard Formable Cable Assemblies						
PE-SR405FL Coax, 50 Ohm						
Part No. <b>PE39448</b>	Cable Dia.		Attn. @ 1 GHz	Power @ 1 GHz		
1 piece price shown. See web or call for volume pricing.						
6"	9"	12"	18"	24"	-	Custom Len.
\$65.98	\$55.56	\$65.98	\$71.84	\$77.70	-	See Web
PE-SR405FLJ Coax, 50 Ohm						
Part No. <b>PE39462</b>	Cable Dia.		Attn. @ 1 GHz	Power @ 1 GHz		
1 piece price shown. See web or call for volume pricing.						
6"	9"	12"	18"	24"	-	Custom Len.
\$62.10	\$52.49	\$62.10	\$66.59	\$71.08	-	See Web
Standard Flexible Cable Assemblies						
RG174A/U Coax, 50 Ohm						
Part No. <b>PE34351</b>	Cable Dia.		Attn. @ 1 GHz	Power @ 1 GHz		
1 piece price shown. See web or call for volume pricing.						
12"	24"	36"	48"	60"	-	Custom Len.
\$84.02	\$78.24	\$85.18	\$79.10	\$79.54	-	See Web
RG316/U Coax, 50 Ohm						
Part No. <b>PE33014</b>	Cable Dia.		Attn. @ 1 GHz	Power @ 1 GHz		
1 piece price shown. See web or call for volume pricing.						
12"	24"	36"	48"	60"	-	Custom Len.
\$75.68	\$75.66	\$78.55	\$85.24	\$84.33	-	See Web
RG400/U Coax, 50 Ohm						
Part No. <b>PE3179</b>	Cable Dia.		Attn. @ 1 GHz	Power @ 1 GHz		
1 piece price shown. See web or call for volume pricing.						
12"	24"	36"	48"	60"	-	Custom Len.
\$77.59	\$80.18	\$92.38	\$94.12	\$101.08	-	See Web
SMA MALE RIGHT ANGLE TO SMA MALE						
Low Loss Flexible Cable Assemblies						
PE-P142LL Coax, 50 Ohm						
Part No. <b>PE342</b>	Cable Dia.		Attn. @ 1 GHz	Power @ 1 GHz		
1 piece price shown. See web or call for volume pricing.						
12"	24"	36"	48"	60"	50CM	Custom Len.
\$196.16	\$212.40	\$228.63	\$244.87	\$261.11	\$206.57	See Web
Standard Formable Cable Assemblies						
PE-SR405FLJ Coax, 50 Ohm						
Part No. <b>PE39431</b>	Cable Dia.		Attn. @ 1 GHz	Power @ 1 GHz		
1 piece price shown. See web or call for volume pricing.						
6"	9"	12"	18"	24"	-	Custom Len.
\$42.12	\$40.04	\$42.12	\$46.61	\$51.10	-	See Web
Standard Flexible Cable Assemblies						
RG316/U Coax, 50 Ohm						
Part No. <b>PE3W06425</b>	Cable Dia.		Attn. @ 1 GHz	Power @ 1 GHz		
1 piece price shown. See web or call for volume pricing.						
12"	24"	36"	48"	60"	50CM	Custom Len.
\$54.29	\$57.56	\$60.84	\$64.13	\$67.41	\$56.39	See Web
RG316-DS Coax, 50 Ohm						
Part No. <b>PE3W06660</b>	Cable Dia.		Attn. @ 1 GHz	Power @ 1 GHz		
1 piece price shown. See web or call for volume pricing.						
12"	24"	36"	48"	60"	50CM	Custom Len.
\$59.38	\$62.55	\$65.87	\$69.12	\$72.38	\$61.46	See Web

Cable Assemblies

See Our Website For Current Pricing & Real-Time Stock Availability!

For Custom Lengths, Metric Lengths or Special Configurations, Please call (949) 261-1920



Technical Support  
+1 (949) 261-1920



Same-Day Shipping,  
Even Custom Cable Assemblies

For our complete selection of cable assemblies, please visit our website

**SMA MALE RIGHT ANGLE TO SMA MALE RIGHT ANGLE**



**Precision Formable Cable Assemblies**

**PE-SR402FLJ Coax, 50 Ohm**

Part No. <b>PE39438</b>	Cable Dia.	Attn. @ 1 GHz	Power @ 1 GHz
1 piece price shown. See web or call for volume pricing.			
6"	12"	18"	24"
\$30.28	\$28.33	\$30.28	\$34.60
		\$38.92	-
			See Web

**Low Loss Flexible Cable Assemblies**

**PE-C195 Coax, 50 Ohm**

Part No. <b>PE35347</b>	Cable Dia.	Attn. @ 1 GHz	Power @ 1 GHz
1 piece price shown. See web or call for volume pricing.			
12"	24"	36"	48"
\$55.15	\$51.77	\$52.49	\$53.21
			\$53.92
			See Web

**PE-C240 Coax, 50 Ohm**

Part No. <b>PE38920</b>	Cable Dia.	Attn. @ 1 GHz	Power @ 1 GHz
1 piece price shown. See web or call for volume pricing.			
12"	24"	36"	48"
\$79.10	\$77.44	\$80.26	\$82.57
			\$83.72
			See Web

**PE-P142LL Coax, 50 Ohm**

Part No. <b>PE3C1425</b>	Cable Dia.	Attn. @ 1 GHz	Power @ 1 GHz
1 piece price shown. See web or call for volume pricing.			
12"	24"	36"	48"
\$282.83	\$299.07	\$315.31	\$331.53
			\$347.77
			\$293.23
			See Web

**PE-P142LL-27478 Coax, 50 Ohm**

Part No. <b>PE3M0152</b>	Cable Dia.	Attn. @ 1 GHz	Power @ 1 GHz
1 piece price shown. See web or call for volume pricing.			
12"	18"	24"	36"
\$548.17	\$556.64	\$565.12	\$582.08
			\$599.04
			\$615.99
			See Web

**PE-P160LL-27478 Coax, 50 Ohm**

Part No. <b>PE3M0197</b>	Cable Dia.	Attn. @ 1 GHz	Power @ 1 GHz
1 piece price shown. See web or call for volume pricing.			
8"	12"	18"	24"
\$552.49	\$557.38	\$564.74	\$572.08
			\$579.44
			\$586.79
			See Web

**PE-P300LL-27478 Coax, 50 Ohm**

Part No. <b>PE3M0232</b>	Cable Dia.	Attn. @ 1 GHz	Power @ 1 GHz
1 piece price shown. See web or call for volume pricing.			
12"	18"	24"	36"
\$642.49	\$656.64	\$670.79	\$699.09
			\$727.39
			\$755.70
			See Web

**PE-P160LL Coax, 50 Ohm**

Part No. <b>PE3C5248</b>	Cable Dia.	Attn. @ 1 GHz	Power @ 1 GHz
1 piece price shown. See web or call for volume pricing.			
12"	24"	36"	48"
\$279.67	\$300.39	\$321.09	\$341.80
			\$362.52
			\$292.94
			See Web

**Low PIM Corrugated Cable Assemblies**

**SPP-250-LLPL Coax, 50 Ohm**

Part No. <b>PE3C5895</b>	Cable Dia.	Attn. @ 1 GHz	Power @ 1 GHz
1 piece price shown. See web or call for volume pricing.			
12"	24"	36"	48"
\$60.26	\$65.84	\$71.42	\$77.00
			\$82.58
			\$63.84
			See Web

**Low Loss Test Flexible Cable Assemblies**

**PE-P300LL Coax, 50 Ohm**

Part No. <b>PE3C2884</b>	Cable Dia.	Attn. @ 1 GHz	Power @ 1 GHz
1 piece price shown. See web or call for volume pricing.			
12"	24"	36"	48"
\$316.76	\$341.95	\$367.13	\$392.31
			\$417.49
			\$332.91
			See Web

**Standard Formable Cable Assemblies**

**PE-SR047FL Coax, 50 Ohm**

Part No. <b>PE34209</b>	Cable Dia.	Attn. @ 1 GHz	Power @ 1 GHz
1 piece price shown. See web or call for volume pricing.			
6"	12"	18"	24"
\$154.09	\$154.09	\$157.79	\$161.47
			\$168.84
			\$176.21
			See Web

**PE-SR401FL Coax, 50 Ohm**

Part No. <b>PE34217</b>	Cable Dia.	Attn. @ 1 GHz	Power @ 1 GHz
1 piece price shown. See web or call for volume pricing.			
6"	12"	18"	24"
\$160.89	\$159.26	\$166.96	\$174.67
			\$190.06
			\$205.46
			See Web

**PE-SR402FL Coax, 50 Ohm**

Part No. <b>PE3417</b>	Cable Dia.	Attn. @ 1 GHz	Power @ 1 GHz
1 piece price shown. See web or call for volume pricing.			
6"	12"	18"	24"
\$80.12	\$84.04	\$88.08	\$92.12
			\$100.20
			\$104.21
			See Web

Part No. <b>PE39424</b>	Cable Dia.	Attn. @ 1 GHz	Power @ 1 GHz
1 piece price shown. See web or call for volume pricing.			
6"	9"	12"	18"
\$61.32	\$59.35	\$61.32	\$65.50
			\$69.68
			See Web

**PE-SR405FL Coax, 50 Ohm**

Part No. <b>PE39416</b>	Cable Dia.	Attn. @ 1 GHz	Power @ 1 GHz
1 piece price shown. See web or call for volume pricing.			
6"	9"	12"	18"
\$61.19	\$61.19	\$64.85	\$70.53
			\$76.20
			See Web

Part No. <b>PE3646</b>	Cable Dia.	Attn. @ 1 GHz	Power @ 1 GHz
1 piece price shown. See web or call for volume pricing.			
6"	12"	18"	24"
\$100.03	\$104.04	\$109.71	\$110.73
			\$121.41
			\$132.11
			See Web

**PE-SR405FLJ Coax, 50 Ohm**

Part No. <b>PE39430</b>	Cable Dia.	Attn. @ 1 GHz	Power @ 1 GHz
1 piece price shown. See web or call for volume pricing.			
6"	9"	12"	18"
\$32.19	\$30.11	\$32.19	\$36.68
			\$41.17
			See Web

**Standard Flexible Cable Assemblies**

**RG58C/U Coax, 50 Ohm**

Part No. <b>PE3655</b>	Cable Dia.	Attn. @ 1 GHz	Power @ 1 GHz
1 piece price shown. See web or call for volume pricing.			
6"	12"	18"	24"
\$58.35	\$58.75	\$58.15	\$56.14
			\$60.38
			\$57.57
			See Web

**RG142B/U Coax, 50 Ohm**

Part No. <b>PE3514</b>	Cable Dia.	Attn. @ 1 GHz	Power @ 1 GHz
1 piece price shown. See web or call for volume pricing.			
6"	12"	18"	24"
\$65.17	\$68.12	\$67.13	\$70.00
			\$80.27
			\$86.70
			See Web

**RG174A/U Coax, 50 Ohm**

Part No. <b>PE3775</b>	Cable Dia.	Attn. @ 1 GHz	Power @ 1 GHz
1 piece price shown. See web or call for volume pricing.			
6"	12"	18"	24"
\$64.38	\$64.66	\$64.95	\$65.24
			\$63.05
			\$66.42
			See Web

**RG178B/U Coax, 50 Ohm**

Part No. <b>PE3876</b>	Cable Dia.	Attn. @ 1 GHz	Power @ 1 GHz
1 piece price shown. See web or call for volume pricing.			
6"	12"	18"	24"
\$86.51	\$82.09	\$87.55	\$88.08
			\$84.00
			\$84.96
			See Web

**RG188A/U Coax, 50 Ohm**

Part No. <b>PE3511</b>	Cable Dia.	Attn. @ 1 GHz	Power @ 1 GHz
1 piece price shown. See web or call for volume pricing.			
6"	12"	18"	24"
\$70.34	\$66.25	\$72.79	\$74.04
			\$76.53
			\$72.91
			See Web

**RG188-DS Coax, 50 Ohm**

Part No. <b>PE3347</b>	Cable Dia.	Attn. @ 1 GHz	Power @ 1 GHz
1 piece price shown. See web or call for volume pricing.			
6"	12"	18"	24"
\$69.20	\$73.35	\$70.90	\$72.59
			\$75.99
			\$79.39
			See Web

**RG223/U Coax, 50 Ohm**

Part No. <b>PE3428</b>	Cable Dia.	Attn. @ 1 GHz	Power @ 1 GHz
1 piece price shown. See web or call for volume pricing.			
6"	12"	18"	24"
\$62.38	\$63.89	\$61.72	\$63.17
			\$66.07
			\$73.42
			See Web

**RG316/U Coax, 50 Ohm**

Part No. <b>PE3515</b>	Cable Dia.	Attn. @ 1 GHz	Power @ 1 GHz
1 piece price shown. See web or call for volume pricing.			
6"	12"	18"	24"
\$65.80	\$67.32	\$68.89	\$70.44
			\$73.57
			\$76.88
			See Web

**RG316-DS Coax, 50 Ohm**

Part No. <b>PE3987</b>	Cable Dia.	Attn. @ 1 GHz	Power @ 1 GHz
1 piece price shown. See web or call for volume pricing.			
6"	12"	18"	24"
\$68.71	\$70.23	\$71.78	\$73.34
			\$76.47
			\$74.97
			See Web

**RG400/U Coax, 50 Ohm**

Part No. <b>PE3713</b>	Cable Dia.	Attn. @ 1 GHz	Power @ 1 GHz
1 piece price shown. See web or call for volume pricing.			
6"	12"	18"	24"
\$73.71	\$73.71	\$83.30	\$80.68
			\$94.39
			\$94.63
			See Web

**PE-P086EAM Coax, 50 Ohm**

Part No. <b>PE3CA1041</b>	Cable Dia.	Attn. @ 1 GHz	Power @ 1 GHz
1 piece price shown. See web or call for volume pricing.			
12"	24"	36"	50CM
\$69.91	\$82.15	\$94.39	\$77.68
			\$97.82
			See Web

**PE-P141EAM Coax, 50 Ohm**

Part No. <b>PE3CA1037</b>	Cable Dia.	Attn. @ 1 GHz	Power @ 1 GHz
1 piece price shown. See web or call for volume pricing.			
12"	24"	36"	50CM
\$81.30	\$100.39	\$119.49	\$93.53
			\$124.83
			See Web

**Standard Semi-Rigid Cable Assemblies**

**PE-020SR Coax, 50 Ohm**

Part No. <b>PE34211</b>	Cable Dia.	Attn. @ 1 GHz	Power @ 1 GHz
1 piece price shown. See web or call for volume pricing.			
6"	12"	18"	24"
\$154.80	\$163.57	\$172.38	\$181.16
			\$198.74
			\$216.32
			See Web

**PE-047SR Coax, 50 Ohm**

Part No. <b>PE3147</b>	Cable Dia.	Attn. @ 1 GHz	Power @ 1 GHz
1 piece price shown. See web or call for volume pricing.			
6"	12"	18"	24"
\$143.22	\$148.20	\$153.13	\$158.10
			\$168.01
			\$177.96
			See Web

**PE-SR047AL Coax, 50 Ohm**

Cable Assemblies  
See Our Website For Current Pricing & Real-Time Stock Availability!

\*Coax Performance at 1 GHz Notes: Cable assembly max frequency may be lower than connector or coax max frequency

For our complete selection of cable assemblies, please visit our website

Part No.	Cable Dia.				Attn. @ 1 GHz	Power @ 1 GHz
Part No. <b>PE3259</b>	" dia.				41 dB/100ft	32 W
1 piece price shown. See web or call for volume pricing.						
6"	12"	18"	24"	36"	48"	Custom Len.
\$142.68	\$147.06	\$151.44	\$155.83	\$164.65	\$173.46	See Web
<b>PE-SR402AL Coax, 50 Ohm</b>						
Part No. <b>PE34208</b>	0.141" dia.				13 dB/100ft	450 W
1 piece price shown. See web or call for volume pricing.						
6"	12"	18"	24"	36"	48"	Custom Len.
\$85.16	\$90.27	\$95.36	\$100.44	\$103.97	\$113.39	See Web
<b>PE-SR405AL Coax, 50 Ohm</b>						
Part No. <b>PE34213</b>	" dia.				23 dB/100ft	130 W
1 piece price shown. See web or call for volume pricing.						
6"	12"	18"	24"	36"	48"	Custom Len.
\$89.99	\$94.19	\$98.32	\$102.53	\$110.88	\$119.27	See Web
<b>RG401/U Coax, 50 Ohm</b>						
Part No. <b>PE34223</b>	" dia.				8 dB/100ft	870 W
1 piece price shown. See web or call for volume pricing.						
6"	12"	18"	24"	36"	48"	Custom Len.
\$165.99	\$165.99	\$176.97	\$187.94	\$209.89	\$231.83	See Web
<b>RG402/U Coax, 50 Ohm</b>						
Part No. <b>PE3819</b>	" dia.				12 dB/100ft	650 W
1 piece price shown. See web or call for volume pricing.						
6"	12"	18"	24"	36"	48"	Custom Len.
\$84.17	\$87.96	\$86.65	\$90.30	\$103.61	\$104.90	See Web
<b>RG405/U Coax, 50 Ohm</b>						
Part No. <b>PE3820</b>	" dia.				22 dB/100ft	130 W
1 piece price shown. See web or call for volume pricing.						
6"	12"	18"	24"	36"	48"	Custom Len.
\$89.15	\$92.45	\$95.74	\$99.10	\$105.77	\$112.37	See Web
<b>PE-SR401AL-STRAIGHT Coax, 50 Ohm</b>						
Part No. <b>PE34215</b>	0.250" dia.				8 dB/100ft	1400 W
1 piece price shown. See web or call for volume pricing.						
6"	12"	18"	24"	36"	48"	Custom Len.
\$162.06	\$162.06	\$171.13	\$180.21	\$198.35	\$216.49	See Web

**Standard Flexible Cable Assemblies**

Part No.	Cable Dia.				Attn. @ 1 GHz	Power @ 1 GHz
Part No. <b>PE3380</b>	0.242" dia.				12 dB/100ft	77 W
1 piece price shown. See web or call for volume pricing.						
6"	12"	18"	24"	36"	48"	Custom Len.
\$80.38	\$80.80	\$81.28	\$81.71	\$82.60	\$83.50	See Web
<b>RG179B/U Coax, 75 Ohm</b>						
Part No. <b>PE3858</b>	0.100" dia.				25 dB/100ft	200 W
1 piece price shown. See web or call for volume pricing.						
6"	12"	18"	24"	36"	48"	Custom Len.
\$73.46	\$73.46	\$74.64	\$75.83	\$78.20	\$80.55	See Web
<b>RG180B/U Coax, 95 Ohm</b>						
Part No. <b>PE3141</b>	0.141" dia.				dB/100ft	250 W
1 piece price shown. See web or call for volume pricing.						
6"	12"	18"	24"	36"	48"	Custom Len.
\$64.53	\$64.69	\$66.69	\$68.69	\$72.68	\$76.68	See Web

**SMA MALE RIGHT ANGLE TO SMA FEMALE**



**Low Loss Flexible Cable Assemblies**

Part No.	Cable Dia.				Attn. @ 1 GHz	Power @ 1 GHz
Part No. <b>PE3C2305</b>	0.195" dia.				10 dB/100ft	W
1 piece price shown. See web or call for volume pricing.						
12"	24"	36"	48"	60"	50CM	Custom Len.
\$225.89	\$242.13	\$258.37	\$274.61	\$290.84	\$236.30	See Web

**Standard Formable Cable Assemblies**

Part No.	Cable Dia.				Attn. @ 1 GHz	Power @ 1 GHz
Part No. <b>PE3W02994</b>	0.098" dia.				20 dB/100ft	122 W
1 piece price shown. See web or call for volume pricing.						
12"	24"	36"	48"	60"	50CM	Custom Len.
\$48.53	\$57.48	\$66.43	\$75.39	\$84.35	\$54.27	See Web

**SMA MALE RIGHT ANGLE TO SMA FEMALE BULKHEAD**  
SEE MOUNTING HOLE SECTION ON PAGE 369



**Precision Formable Cable Assemblies**

Part No.	Cable Dia.				Attn. @ 1 GHz	Power @ 1 GHz
Part No. <b>PE39428</b>	" dia.				12 dB/100ft	450 W
1 piece price shown. See web or call for volume pricing.						
6"	9"	12"	18"	24"	-	Custom Len.
\$42.92	\$40.96	\$42.92	\$47.10	\$51.27	-	See Web
<b>PE-SR402FLJ Coax, 50 Ohm</b>						
Part No. <b>PE39442</b>	0.161" dia.				12 dB/100ft	450 W
1 piece price shown. See web or call for volume pricing.						
6"	9"	12"	18"	24"	-	Custom Len.
\$44.31	\$42.30	\$44.31	\$48.80	\$53.29	-	See Web

**Low Loss Flexible Cable Assemblies**

Part No.	Cable Dia.				Attn. @ 1 GHz	Power @ 1 GHz
Part No. <b>PE38574</b>	0.109" dia.				25 dB/100ft	W
1 piece price shown. See web or call for volume pricing.						
12"	24"	36"	48"	60"	-	Custom Len.
\$51.88	\$53.08	\$54.29	\$55.49	\$56.69	-	See Web
<b>PE-P160LL Coax, 50 Ohm</b>						
Part No. <b>PE3C5244</b>	0.160" dia.				dB/100ft	W
1 piece price shown. See web or call for volume pricing.						
12"	24"	36"	48"	60"	50CM	Custom Len.
\$259.56	\$280.28	\$300.99	\$321.70	\$342.41	\$272.83	See Web

**Standard Formable Cable Assemblies**

Part No.	Cable Dia.				Attn. @ 1 GHz	Power @ 1 GHz
Part No. <b>PE34319</b>	" dia.				8 dB/100ft	1400 W
1 piece price shown. See web or call for volume pricing.						
6"	12"	18"	24"	36"	48"	Custom Len.
\$125.27	\$132.78	\$140.21	\$147.73	\$162.67	\$177.60	See Web
<b>PE-SR402FL Coax, 50 Ohm</b>						
Part No. <b>PE34299</b>	" dia.				12 dB/100ft	450 W
1 piece price shown. See web or call for volume pricing.						
6"	12"	18"	24"	36"	48"	Custom Len.
\$73.54	\$71.72	\$75.48	\$79.25	\$86.80	\$94.33	See Web
<b>PE-SR405FL Coax, 50 Ohm</b>						
Part No. <b>PE34313</b>	" dia.				23 dB/100ft	130 W
1 piece price shown. See web or call for volume pricing.						
6"	12"	18"	24"	36"	48"	Custom Len.
\$85.47	\$85.47	\$96.26	\$96.17	\$106.86	\$117.56	See Web
<b>PE39420</b>						
1 piece price shown. See web or call for volume pricing.						
6"	9"	12"	18"	24"	-	Custom Len.
\$50.94	\$48.29	\$50.94	\$56.52	\$62.10	-	See Web

**Standard Flexible Cable Assemblies**

Part No.	Cable Dia.				Attn. @ 1 GHz	Power @ 1 GHz
Part No. <b>PE3759</b>	0.195" dia.				13 dB/100ft	650 W
1 piece price shown. See web or call for volume pricing.						
6"	12"	18"	24"	36"	48"	Custom Len.
\$60.57	\$58.82	\$61.69	\$64.54	\$70.28	\$76.00	See Web
<b>RG174A/U Coax, 50 Ohm</b>						
Part No. <b>PE3149</b>	0.110" dia.				32 dB/100ft	17 W
1 piece price shown. See web or call for volume pricing.						
6"	12"	18"	24"	36"	48"	Custom Len.
\$65.56	\$65.56	\$71.10	\$65.99	\$71.96	\$72.57	See Web
<b>RG178B/U Coax, 50 Ohm</b>						
Part No. <b>PE3152</b>	0.072" dia.				44 dB/100ft	55 W
1 piece price shown. See web or call for volume pricing.						
6"	12"	18"	24"	36"	48"	Custom Len.
\$66.63	\$69.30	\$69.83	\$67.60	\$71.41	\$69.51	See Web
<b>RG188A/U Coax, 50 Ohm</b>						
Part No. <b>PE3050</b>	0.110" dia.				26 dB/100ft	160 W
1 piece price shown. See web or call for volume pricing.						
6"	12"	18"	24"	36"	48"	Custom Len.
\$67.37	\$72.76	\$68.48	\$69.58	\$77.75	\$74.03	See Web
<b>RG188-DS Coax, 50 Ohm</b>						
Part No. <b>PE34179</b>	0.122" dia.				30 dB/100ft	160 W
1 piece price shown. See web or call for volume pricing.						
6"	12"	18"	24"	36"	48"	Custom Len.
\$70.40	\$68.03	\$69.74	\$71.44	\$74.84	\$78.25	See Web
<b>RG196A/U Coax, 50 Ohm</b>						
Part No. <b>PE34141</b>	0.080" dia.				49 dB/100ft	78 W
1 piece price shown. See web or call for volume pricing.						
6"	12"	18"	24"	36"	48"	Custom Len.
\$68.28	\$68.28	\$68.98	\$69.66	\$71.04	\$72.41	See Web
<b>RG223/U Coax, 50 Ohm</b>						
Part No. <b>PE3800</b>	0.210" dia.				13 dB/100ft	53 W
1 piece price shown. See web or call for volume pricing.						
6"	12"	18"	24"	36"	48"	Custom Len.
\$58.93	\$55.97	\$57.42	\$58.87	\$61.77	\$64.67	See Web
<b>RG316/U Coax, 50 Ohm</b>						
Part No. <b>PE3836</b>	0.098" dia.				38 dB/100ft	160 W
1 piece price shown. See web or call for volume pricing.						
6"	12"	18"	24"	36"	48"	Custom Len.
\$67.02	\$67.02	\$68.46	\$69.91	\$72.79	\$75.68	See Web
<b>RG316-DS Coax, 50 Ohm</b>						
Part No. <b>PE34061</b>	0.114" dia.				26 dB/100ft	160 W
1 piece price shown. See web or call for volume pricing.						
6"	12"	18"	24"	36"	48"	Custom Len.
\$68.84	\$67.66	\$69.12	\$70.57	\$73.49	\$76.40	See Web
<b>PE-P195 Coax, 50 Ohm</b>						
Part No. <b>PE33749</b>	0.195" dia.				13 dB/100ft	650 W
1 piece price shown. See web or call for volume pricing.						
6"	12"	18"	24"	36"	48"	Custom Len.
\$68.52	\$68.52	\$72.95	\$77.38	\$86.24	\$95.09	See Web

Cable Assemblies

See Our Website For Current Pricing & Real-Time Stock Availability!

For Custom Lengths, Metric Lengths or Special Configurations, Please call (949) 261-1920



Technical Support  
+1 (949) 261-1920



Same-Day Shipping,  
Even Custom Cable Assemblies

For our complete selection of cable assemblies, please visit our website

Cable Assemblies

See Our Website For Current Pricing & Real-Time Stock Availability!

Standard Semi-Rigid Cable Assemblies						
PE-SR402AL Coax, 50 Ohm						
Part No. <a href="#">PE34297</a>	Cable Dia.	Attn. @ 1 GHz	Power @ 1 GHz			
1 piece price shown. See web or call for volume pricing.						
6"	12"	18"	24"	36"	48"	Custom Len.
\$63.64	\$68.20	\$72.77	\$77.32	\$86.44	\$95.57	See Web
PE-SR405AL Coax, 50 Ohm						
Part No. <a href="#">PE34311</a>	Cable Dia.	Attn. @ 1 GHz	Power @ 1 GHz			
1 piece price shown. See web or call for volume pricing.						
6"	12"	18"	24"	36"	48"	Custom Len.
\$83.37	\$83.37	\$87.69	\$92.01	\$100.66	\$109.29	See Web
RG402/U Coax, 50 Ohm						
Part No. <a href="#">PE3679</a>	Cable Dia.	Attn. @ 1 GHz	Power @ 1 GHz			
1 piece price shown. See web or call for volume pricing.						
6"	12"	18"	24"	36"	48"	Custom Len.
\$70.13	\$70.13	\$73.78	\$77.44	\$84.73	\$92.05	See Web
RG405/U Coax, 50 Ohm						
Part No. <a href="#">PE3925</a>	Cable Dia.	Attn. @ 1 GHz	Power @ 1 GHz			
1 piece price shown. See web or call for volume pricing.						
6"	12"	18"	24"	36"	48"	Custom Len.
\$81.53	\$81.53	\$90.13	\$88.39	\$95.27	\$102.13	See Web
PE-SR401AL-STRAIGHT Coax, 50 Ohm						
Part No. <a href="#">PE34317</a>	Cable Dia.	Attn. @ 1 GHz	Power @ 1 GHz			
1 piece price shown. See web or call for volume pricing.						
6"	12"	18"	24"	36"	48"	Custom Len.
\$143.54	\$143.54	\$152.62	\$161.69	\$179.83	\$197.96	See Web
Standard Flexible Cable Assemblies						
RG179B/U Coax, 75 Ohm						
Part No. <a href="#">PE34135</a>	Cable Dia.	Attn. @ 1 GHz	Power @ 1 GHz			
1 piece price shown. See web or call for volume pricing.						
6"	12"	18"	24"	36"	48"	Custom Len.
\$61.43	\$62.62	\$63.83	\$64.96	\$67.37	\$69.76	See Web
SMA MALE RIGHT ANGLE TO REVERSE POLARITY SMA MALE RIGHT ANGLE						
Standard Flexible Cable Assemblies						
RG174A/U Coax, 50 Ohm						
Part No. <a href="#">PE3W05106</a>	Cable Dia.	Attn. @ 1 GHz	Power @ 1 GHz			
1 piece price shown. See web or call for volume pricing.						
12"	24"	36"	48"	60"	50CM	Custom Len.
\$87.05	\$98.43	\$99.00	\$99.56	\$100.12	\$98.23	See Web
SMA MALE RIGHT ANGLE TO REVERSE POLARITY SMA FEMALE						
Standard Flexible Cable Assemblies						
RG142B/U Coax, 50 Ohm						
Part No. <a href="#">PE3W03763</a>	Cable Dia.	Attn. @ 1 GHz	Power @ 1 GHz			
1 piece price shown. See web or call for volume pricing.						
12"	24"	36"	48"	60"	50CM	Custom Len.
\$66.65	\$72.54	\$78.44	\$84.35	\$90.25	\$70.42	See Web
SMA MALE RIGHT ANGLE TO SMB PLUG						
Standard Flexible Cable Assemblies						
RG174A/U Coax, 50 Ohm						
Part No. <a href="#">PE33482</a>	Cable Dia.	Attn. @ 1 GHz	Power @ 1 GHz			
1 piece price shown. See web or call for volume pricing.						
12"	24"	36"	48"	60"	-	Custom Len.
\$66.48	\$67.06	\$67.63	\$68.24	\$68.83	-	See Web
SMA MALE RIGHT ANGLE TO SMB PLUG RIGHT ANGLE						
Standard Formable Cable Assemblies						
PE-SR405FL Coax, 50 Ohm						
Part No. <a href="#">PE3W01739</a>	Cable Dia.	Attn. @ 1 GHz	Power @ 1 GHz			
1 piece price shown. See web or call for volume pricing.						
12"	24"	36"	48"	60"	50CM	Custom Len.
\$67.08	\$78.09	\$89.10	\$100.12	\$111.13	\$74.13	See Web
SMA MALE RIGHT ANGLE TO SMC PLUG RIGHT ANGLE						
Standard Flexible Cable Assemblies						
RG316/U Coax, 50 Ohm						

Part No. <a href="#">PE3740</a>	Cable Dia.	Attn. @ 1 GHz	Power @ 1 GHz			
1 piece price shown. See web or call for volume pricing.						
12"	24"	36"	48"	60"	50CM	Custom Len.
\$57.16	\$60.19	\$63.22	\$66.26	\$72.32	\$59.10	See Web
SMA MALE RIGHT ANGLE TO SSMC PLUG						
Low Loss Flexible Cable Assemblies						
LMR-100A-PVC Coax, 50 Ohm						
Part No. <a href="#">PE3C4424</a>	Cable Dia.	Attn. @ 1 GHz	Power @ 1 GHz			
1 piece price shown. See web or call for volume pricing.						
6"	12"	18"	24"	36"	48"	Custom Len.
\$59.79	\$60.18	\$60.54	\$60.92	\$61.65	\$62.39	See Web
Standard Formable Cable Assemblies						
PE-SR405FLJ Coax, 50 Ohm						
Part No. <a href="#">PE3C4446</a>	Cable Dia.	Attn. @ 1 GHz	Power @ 1 GHz			
1 piece price shown. See web or call for volume pricing.						
6"	12"	18"	24"	36"	48"	Custom Len.
\$57.98	\$61.75	\$65.52	\$69.27	\$76.79	\$84.33	See Web
Standard Flexible Cable Assemblies						
RG316/U Coax, 50 Ohm						
Part No. <a href="#">PE3C4407</a>	Cable Dia.	Attn. @ 1 GHz	Power @ 1 GHz			
1 piece price shown. See web or call for volume pricing.						
6"	12"	18"	24"	36"	48"	Custom Len.
\$62.96	\$64.31	\$65.66	\$66.99	\$69.70	\$72.38	See Web
SMA MALE RIGHT ANGLE TO SSMC PLUG RIGHT ANGLE						
Low Loss Flexible Cable Assemblies						
LMR-100A-PVC Coax, 50 Ohm						
Part No. <a href="#">PE3C4425</a>	Cable Dia.	Attn. @ 1 GHz	Power @ 1 GHz			
1 piece price shown. See web or call for volume pricing.						
6"	12"	18"	24"	36"	48"	Custom Len.
\$56.37	\$60.16	\$57.11	\$57.48	\$58.22	\$58.95	See Web
Standard Formable Cable Assemblies						
PE-SR405FLJ Coax, 50 Ohm						
Part No. <a href="#">PE3C4485</a>	Cable Dia.	Attn. @ 1 GHz	Power @ 1 GHz			
1 piece price shown. See web or call for volume pricing.						
6"	12"	18"	24"	36"	48"	Custom Len.
\$58.03	\$58.65	\$62.42	\$66.17	\$73.70	\$81.23	See Web
Standard Flexible Cable Assemblies						
RG316/U Coax, 50 Ohm						
Part No. <a href="#">PE3C4408</a>	Cable Dia.	Attn. @ 1 GHz	Power @ 1 GHz			
1 piece price shown. See web or call for volume pricing.						
6"	12"	18"	24"	36"	48"	Custom Len.
\$62.18	\$69.95	\$65.00	\$66.38	\$69.20	\$71.99	See Web
RG316-DS Coax, 50 Ohm						
Part No. <a href="#">PE3C4472</a>	Cable Dia.	Attn. @ 1 GHz	Power @ 1 GHz			
1 piece price shown. See web or call for volume pricing.						
6"	12"	18"	24"	36"	48"	Custom Len.
\$60.44	\$61.85	\$63.28	\$64.68	\$67.50	\$70.33	See Web
SMA MALE RIGHT ANGLE TO SSMC JACK BULKHEAD						
SEE MOUNTING HOLE SECTION ON PAGE 369						
Standard Formable Cable Assemblies						
PE-SR405FLJ Coax, 50 Ohm						
Part No. <a href="#">PE3C4447</a>	Cable Dia.	Attn. @ 1 GHz	Power @ 1 GHz			
1 piece price shown. See web or call for volume pricing.						
6"	12"	18"	24"	36"	48"	Custom Len.
\$56.28	\$54.93	\$58.69	\$62.45	\$69.98	\$77.50	See Web
SMA MALE RIGHT ANGLE TO TNC MALE						
Low Loss Flexible Cable Assemblies						
LMR-100A-PVC Coax, 50 Ohm						
Part No. <a href="#">PE3W01985</a>	Cable Dia.	Attn. @ 1 GHz	Power @ 1 GHz			
1 piece price shown. See web or call for volume pricing.						
12"	24"	36"	48"	60"	50CM	Custom Len.
\$57.05	\$57.79	\$58.53	\$59.25	\$59.99	\$57.53	See Web
PE-P142LL Coax, 50 Ohm						
Part No. <a href="#">PE3C1179</a>	Cable Dia.	Attn. @ 1 GHz	Power @ 1 GHz			
1 piece price shown. See web or call for volume pricing.						
12"	24"	36"	48"	60"	50CM	Custom Len.
\$223.69	\$239.93	\$256.16	\$272.39	\$288.63	\$234.10	See Web

\*Coax Performance at 1 GHz Notes: Cable assembly max frequency may be lower than connector or coax max frequency



# For our complete selection of cable assemblies, please visit our website

PE-P142LL-27478 Coax, 50 Ohm						
Part No. <a href="#">PE3M0153</a>	Cable Dia.	Attn. @ 1 GHz	Power @ 1 GHz			
1 piece price shown. See web or call for volume pricing.						
12"	18"	24"	36"	48"	60"	Custom Len.
\$467.46	\$475.93	\$484.41	\$501.37	\$518.33	\$535.28	See Web
PE-P160LL-27478 Coax, 50 Ohm						
Part No. <a href="#">PE3M0198</a>	Cable Dia.	Attn. @ 1 GHz	Power @ 1 GHz			
1 piece price shown. See web or call for volume pricing.						
8"	12"	18"	24"	30"	36"	Custom Len.
\$459.60	\$464.51	\$471.85	\$479.21	\$486.55	\$493.91	See Web
PE-P300LL-27478 Coax, 50 Ohm						
Part No. <a href="#">PE3M0233</a>	Cable Dia.	Attn. @ 1 GHz	Power @ 1 GHz			
1 piece price shown. See web or call for volume pricing.						
12"	18"	24"	36"	48"	60"	Custom Len.
\$526.30	\$540.45	\$554.60	\$582.90	\$611.20	\$639.50	See Web
PE-P160LL Coax, 50 Ohm						
Part No. <a href="#">PE3C5261</a>	Cable Dia.	Attn. @ 1 GHz	Power @ 1 GHz			
1 piece price shown. See web or call for volume pricing.						
12"	24"	36"	48"	60"	50CM	Custom Len.
\$242.55	\$263.27	\$283.98	\$304.70	\$325.40	\$255.82	See Web
Standard Flexible Cable Assemblies						
RG142B/U Coax, 50 Ohm						
Part No. <a href="#">PE3W06829</a>	Cable Dia.	Attn. @ 1 GHz	Power @ 1 GHz			
1 piece price shown. See web or call for volume pricing.						
12"	24"	36"	48"	60"	50CM	Custom Len.
\$62.29	\$68.18	\$74.08	\$79.98	\$85.88	\$66.06	See Web
SMA MALE RIGHT ANGLE TO TNC MALE RIGHT ANGLE						
Low Loss Flexible Cable Assemblies						
PE-P142LL Coax, 50 Ohm						
Part No. <a href="#">PE3C1409</a>	Cable Dia.	Attn. @ 1 GHz	Power @ 1 GHz			
1 piece price shown. See web or call for volume pricing.						
12"	24"	36"	48"	60"	50CM	Custom Len.
\$304.33	\$320.56	\$336.80	\$353.04	\$370.58	\$314.73	See Web
PE-P142LL-27478 Coax, 50 Ohm						
Part No. <a href="#">PE3M0155</a>	Cable Dia.	Attn. @ 1 GHz	Power @ 1 GHz			
1 piece price shown. See web or call for volume pricing.						
12"	18"	24"	36"	48"	60"	Custom Len.
\$574.14	\$582.62	\$591.10	\$608.05	\$625.01	\$641.97	See Web
PE-P160LL-27478 Coax, 50 Ohm						
Part No. <a href="#">PE3M0200</a>	Cable Dia.	Attn. @ 1 GHz	Power @ 1 GHz			
1 piece price shown. See web or call for volume pricing.						
8"	12"	18"	24"	30"	36"	Custom Len.
\$544.61	\$549.52	\$556.86	\$564.22	\$571.56	\$578.92	See Web
PE-P300LL-27478 Coax, 50 Ohm						
Part No. <a href="#">PE3M0234</a>	Cable Dia.	Attn. @ 1 GHz	Power @ 1 GHz			
1 piece price shown. See web or call for volume pricing.						
12"	18"	24"	36"	48"	60"	Custom Len.
\$670.58	\$684.73	\$698.88	\$727.19	\$755.49	\$783.79	See Web
PE-P160LL Coax, 50 Ohm						
Part No. <a href="#">PE3C5262</a>	Cable Dia.	Attn. @ 1 GHz	Power @ 1 GHz			
1 piece price shown. See web or call for volume pricing.						
12"	24"	36"	48"	60"	50CM	Custom Len.
\$301.32	\$322.04	\$342.75	\$363.45	\$384.17	\$314.59	See Web
SMA MALE RIGHT ANGLE TO TNC FEMALE BULKHEAD						
SEE MOUNTING HOLE SECTION ON PAGE 369						
Precision Formable Cable Assemblies						
PE-SR402FL Coax, 50 Ohm						
Part No. <a href="#">PE39484</a>	Cable Dia.	Attn. @ 1 GHz	Power @ 1 GHz			
1 piece price shown. See web or call for volume pricing.						
6"	9"	12"	18"	24"	-	Custom Len.
\$46.71	\$43.25	\$46.71	\$50.73	\$54.75	-	See Web
PE-SR402FLJ Coax, 50 Ohm						
Part No. <a href="#">PE39498</a>	Cable Dia.	Attn. @ 1 GHz	Power @ 1 GHz			
1 piece price shown. See web or call for volume pricing.						
6"	9"	12"	18"	24"	-	Custom Len.
\$50.72	\$46.96	\$50.72	\$55.21	\$59.70	-	See Web
PE-SR405FL Coax, 50 Ohm						
Part No. <a href="#">PE39476</a>	Cable Dia.	Attn. @ 1 GHz	Power @ 1 GHz			
1 piece price shown. See web or call for volume pricing.						
6"	9"	12"	18"	24"	-	Custom Len.
\$51.70	\$53.29	\$51.70	\$57.50	\$63.30	-	See Web
Low Loss Flexible Cable Assemblies						
LMR-195 Coax, 50 Ohm						
Part No. <a href="#">PE3C0056</a>	Cable Dia.	Attn. @ 1 GHz	Power @ 1 GHz			
1 piece price shown. See web or call for volume pricing.						
12"	24"	36"	48"	60"	-	Custom Len.
\$53.31	\$54.06	\$50.86	\$51.61	\$52.36	-	See Web

Part No. <a href="#">PE3C1173</a>						
Cable Dia.	Attn. @ 1 GHz	Power @ 1 GHz				
1 piece price shown. See web or call for volume pricing.						
12"	24"	36"	48"	60"	50CM	Custom Len.
\$259.03	\$275.26	\$291.50	\$307.74	\$323.98	\$269.44	See Web
PE-P142LL-27478 Coax, 50 Ohm						
Part No. <a href="#">PE3M0154</a>	Cable Dia.	Attn. @ 1 GHz	Power @ 1 GHz			
1 piece price shown. See web or call for volume pricing.						
12"	18"	24"	36"	48"	60"	Custom Len.
\$546.32	\$554.79	\$563.27	\$580.23	\$597.19	\$614.14	See Web
PE-P160LL-27478 Coax, 50 Ohm						
Part No. <a href="#">PE3M0199</a>	Cable Dia.	Attn. @ 1 GHz	Power @ 1 GHz			
1 piece price shown. See web or call for volume pricing.						
8"	12"	18"	24"	30"	36"	Custom Len.
\$540.67	\$545.58	\$552.92	\$560.28	\$567.63	\$574.98	See Web
PE-P160LL Coax, 50 Ohm						
Part No. <a href="#">PE3C5263</a>	Cable Dia.	Attn. @ 1 GHz	Power @ 1 GHz			
1 piece price shown. See web or call for volume pricing.						
12"	24"	36"	48"	60"	50CM	Custom Len.
\$268.84	\$289.56	\$310.27	\$330.97	\$351.69	\$282.11	See Web
Standard Formable Cable Assemblies						
PE-SR402FL Coax, 50 Ohm						
Part No. <a href="#">PE3W00169</a>	Cable Dia.	Attn. @ 1 GHz	Power @ 1 GHz			
1 piece price shown. See web or call for volume pricing.						
12"	24"	36"	48"	60"	50CM	Custom Len.
\$81.35	\$89.20	\$97.04	\$104.89	\$114.92	\$86.73	See Web
PE-SR405FLJ Coax, 50 Ohm						
Part No. <a href="#">PE39490</a>	Cable Dia.	Attn. @ 1 GHz	Power @ 1 GHz			
1 piece price shown. See web or call for volume pricing.						
6"	9"	12"	18"	24"	-	Custom Len.
\$53.52	\$44.52	\$53.52	\$57.84	\$62.16	-	See Web
Standard Flexible Cable Assemblies						
RG316/U Coax, 50 Ohm						
Part No. <a href="#">PE33073</a>	Cable Dia.	Attn. @ 1 GHz	Power @ 1 GHz			
1 piece price shown. See web or call for volume pricing.						
12"	24"	36"	48"	60"	-	Custom Len.
\$80.15	\$83.27	\$81.37	\$89.70	\$87.16	-	See Web
RG400/U Coax, 50 Ohm						
Part No. <a href="#">PE33759</a>	Cable Dia.	Attn. @ 1 GHz	Power @ 1 GHz			
1 piece price shown. See web or call for volume pricing.						
12"	24"	36"	48"	60"	-	Custom Len.
\$78.86	\$79.99	\$86.96	\$93.93	\$100.90	-	See Web
REVERSE POLARITY SMA MALE RIGHT ANGLE TO N MALE						
Standard Flexible Cable Assemblies						
RG400/U Coax, 50 Ohm						
Part No. <a href="#">PE35991</a>	Cable Dia.	Attn. @ 1 GHz	Power @ 1 GHz			
1 piece price shown. See web or call for volume pricing.						
12"	24"	36"	48"	60"	-	Custom Len.
\$82.86	\$96.89	\$104.27	\$112.11	\$110.74	-	See Web
REVERSE POLARITY SMA MALE RIGHT ANGLE TO N MALE RIGHT ANGLE						
Low Loss Flexible Cable Assemblies						
LMR-195 Coax, 50 Ohm						
Part No. <a href="#">PE3W02390</a>	Cable Dia.	Attn. @ 1 GHz	Power @ 1 GHz			
1 piece price shown. See web or call for volume pricing.						
12"	24"	36"	48"	60"	50CM	Custom Len.
\$74.03	\$74.76	\$75.48	\$76.21	\$76.94	\$74.50	See Web
REVERSE POLARITY SMA MALE RIGHT ANGLE TO SMA MALE						
Standard Flexible Cable Assemblies						
RG400/U Coax, 50 Ohm						
Part No. <a href="#">PE3W06085</a>	Cable Dia.	Attn. @ 1 GHz	Power @ 1 GHz			
1 piece price shown. See web or call for volume pricing.						
12"	24"	36"	48"	60"	50CM	Custom Len.
\$83.18	\$90.80	\$98.41	\$106.03	\$113.65	\$80.45	See Web
SMA FEMALE TO FAKRA PLUG						
Low Loss Flexible Cable Assemblies						
PE-C100-LSZH Coax, 50 Ohm						
Part No. <a href="#">PE39344A</a>	Cable Dia.	Attn. @ 1 GHz	Power @ 1 GHz			
1 piece price shown. See web or call for volume pricing.						
12"	24"	36"	48"	60"	-	Custom Len.
\$41.22	\$38.66	\$39.87	\$41.08	\$42.29	-	See Web

Cable Assemblies

See Our Website For Current Pricing & Real-Time Stock Availability!

For Custom Lengths, Metric Lengths or Special Configurations, Please call (949) 261-1920



Technical Support  
+1 (949) 261-1920



Same-Day Shipping,  
Even Custom Cable Assemblies

For our complete selection of cable assemblies, please visit our website

Cable Assemblies  
See Our Website For Current Pricing & Real-Time Stock Availability!

Part No.	Cable Dia.				Attn. @ 1 GHz	Power @ 1 GHz
<b>PE39344C</b>	0.109" dia.				25 dB/100ft	W
12"	24"	36"	48"	60"	-	Custom Len.
\$41.22	\$38.66	\$39.87	\$41.08	\$42.29	-	See Web
<b>PE39344D</b>	0.109" dia.				25 dB/100ft	W
12"	24"	36"	48"	60"	-	Custom Len.
\$41.22	\$42.54	\$39.87	\$41.08	\$42.29	-	See Web
<b>PE39344H</b>	0.109" dia.				25 dB/100ft	W
12"	24"	36"	48"	60"	-	Custom Len.
\$42.43	\$39.79	\$41.00	\$42.19	\$43.40	-	See Web
<b>PE39344I</b>	0.109" dia.				25 dB/100ft	W
12"	24"	36"	48"	60"	-	Custom Len.
\$41.22	\$38.66	\$39.87	\$41.08	\$42.29	-	See Web
<b>PE39344K</b>	0.109" dia.				25 dB/100ft	W
12"	24"	36"	48"	60"	-	Custom Len.
\$37.47	\$42.54	\$39.87	\$41.08	\$42.29	-	See Web
<b>PE39344Z</b>	0.109" dia.				25 dB/100ft	W
12"	24"	36"	48"	60"	-	Custom Len.
\$37.47	\$41.79	\$39.87	\$41.08	\$42.29	-	See Web
<b>Standard Flexible Cable Assemblies</b>						
RG174A/U Coax, 50 Ohm						
<b>PE39345C</b>	0.100" dia.				32 dB/100ft	16 W
12"	24"	36"	48"	60"	-	Custom Len.
\$48.88	\$44.98	\$45.46	\$46.00	\$46.54	-	See Web
<b>PE39345Z</b>	0.100" dia.				32 dB/100ft	16 W
12"	24"	36"	48"	60"	-	Custom Len.
\$48.88	\$44.98	\$45.46	\$46.00	\$46.54	-	See Web
<b>RG316/U Coax, 50 Ohm</b>						
<b>PE39346A</b>	0.098" dia.				38 dB/100ft	160 W
12"	24"	36"	48"	60"	-	Custom Len.
\$51.46	\$54.34	\$57.24	\$60.13	\$63.02	-	See Web
<b>PE39346I</b>	0.098" dia.				38 dB/100ft	160 W
12"	24"	36"	48"	60"	-	Custom Len.
\$51.46	\$54.34	\$57.24	\$60.13	\$63.02	-	See Web
<b>PE39346K</b>	0.098" dia.				38 dB/100ft	160 W
12"	24"	36"	48"	60"	-	Custom Len.
\$51.45	\$49.65	\$52.54	\$55.42	\$58.30	-	See Web
<b>PE39346Z</b>	0.098" dia.				38 dB/100ft	160 W
12"	24"	36"	48"	60"	-	Custom Len.
\$46.78	\$49.65	\$52.54	\$55.42	\$58.30	-	See Web
<b>SMA FEMALE TO FAKRA JACK</b>						
<b>Low Loss Flexible Cable Assemblies</b>						
PE-C100-LSZH Coax, 50 Ohm						
<b>PE39349A</b>	0.109" dia.				25 dB/100ft	W
12"	24"	36"	48"	60"	-	Custom Len.
\$41.22	\$38.66	\$39.87	\$41.08	\$42.29	-	See Web
<b>PE39349B</b>	0.109" dia.				25 dB/100ft	W
12"	24"	36"	48"	60"	-	Custom Len.
\$41.22	\$38.66	\$39.87	\$41.08	\$42.29	-	See Web
<b>PE39349C</b>	0.109" dia.				25 dB/100ft	W
12"	24"	36"	48"	60"	-	Custom Len.
\$41.22	\$38.66	\$39.87	\$41.08	\$46.62	-	See Web
<b>PE39349D</b>	0.109" dia.				25 dB/100ft	W
12"	24"	36"	48"	60"	-	Custom Len.
\$38.98	\$40.31	\$39.20	\$40.40	\$44.40	-	See Web
<b>PE39349H</b>	0.109" dia.				25 dB/100ft	W
12"	24"	36"	48"	60"	-	Custom Len.
\$41.22	\$38.66	\$39.87	\$41.08	\$42.29	-	See Web
<b>PE39349I</b>	0.109" dia.				25 dB/100ft	W
12"	24"	36"	48"	60"	-	Custom Len.
\$41.22	\$38.66	\$39.87	\$41.08	\$42.29	-	See Web
<b>PE39349K</b>	0.109" dia.				25 dB/100ft	W
12"	24"	36"	48"	60"	-	Custom Len.
\$37.47	\$42.54	\$39.87	\$41.08	\$42.29	-	See Web

Part No.	Cable Dia.				Attn. @ 1 GHz	Power @ 1 GHz
<b>PE39349Z</b>	0.109" dia.				25 dB/100ft	W
12"	24"	36"	48"	60"	-	Custom Len.
\$41.22	\$38.66	\$43.87	\$41.08	\$46.62	-	See Web
<b>Standard Flexible Cable Assemblies</b>						
RG174A/U Coax, 50 Ohm						
<b>PE39350A</b>	0.100" dia.				32 dB/100ft	16 W
12"	24"	36"	48"	60"	-	Custom Len.
\$48.88	\$49.32	\$49.75	\$50.18	\$50.63	-	See Web
<b>PE39350B</b>	0.100" dia.				32 dB/100ft	16 W
12"	24"	36"	48"	60"	-	Custom Len.
\$48.00	\$48.43	\$48.86	\$49.30	\$49.73	-	See Web
<b>PE39350C</b>	0.100" dia.				32 dB/100ft	16 W
12"	24"	36"	48"	60"	-	Custom Len.
\$48.88	\$49.32	\$49.75	\$50.18	\$50.63	-	See Web
<b>PE39350D</b>	0.100" dia.				32 dB/100ft	16 W
12"	24"	36"	48"	60"	-	Custom Len.
\$47.11	\$44.98	\$45.46	\$46.00	\$46.54	-	See Web
<b>PE39350Z</b>	0.100" dia.				32 dB/100ft	16 W
12"	24"	36"	48"	60"	-	Custom Len.
\$53.78	\$49.32	\$49.75	\$50.18	\$50.63	-	See Web
<b>RG316/U Coax, 50 Ohm</b>						
<b>PE39351A</b>	0.098" dia.				38 dB/100ft	160 W
12"	24"	36"	48"	60"	-	Custom Len.
\$51.46	\$54.34	\$57.24	\$60.13	\$63.02	-	See Web
<b>PE39351C</b>	0.098" dia.				38 dB/100ft	160 W
12"	24"	36"	48"	60"	-	Custom Len.
\$56.60	\$54.34	\$57.24	\$60.13	\$63.02	-	See Web
<b>SMA FEMALE TO MCX PLUG RIGHT ANGLE</b>						
<b>Standard Formable Cable Assemblies</b>						
PE-SR405FLJ Coax, 50 Ohm						
<b>PE3W03859</b>	0.105" dia.				20 dB/100ft	122 W
12"	24"	36"	48"	60"	-	Custom Len.
\$67.42	\$76.38	\$85.33	\$94.29	\$103.25	\$73.16	See Web
<b>SMA FEMALE TO MMCX PLUG</b>						
<b>Standard Flexible Cable Assemblies</b>						
RG188-DS Coax, 50 Ohm						
<b>PE3W03032</b>	0.118" dia.				30 dB/100ft	160 W
12"	24"	36"	48"	60"	-	Custom Len.
\$59.35	\$63.05	\$66.75	\$70.44	\$74.14	\$61.72	See Web
<b>SMA FEMALE TO N MALE</b>						
<b>Precision Flexible Cable Assemblies</b>						
PE-P141 Coax, 50 Ohm						
<b>PE356</b>	0.163" dia.				dB/100ft	W
12"	24"	36"	48"	60"	72"	Custom Len.
\$174.22	\$175.07	\$196.93	\$208.94	\$207.18	\$232.09	See Web
<b>Low Loss Flexible Cable Assemblies</b>						
PE-P142LL-27478 Coax, 50 Ohm						
<b>PE3M0141</b>	0.195" dia.				dB/100ft	W
12"	18"	24"	36"	48"	60"	Custom Len.
\$425.72	\$434.20	\$442.68	\$459.63	\$476.59	\$493.55	See Web
<b>SMA FEMALE TO N MALE RIGHT ANGLE</b>						
<b>Low Loss Flexible Cable Assemblies</b>						
PE-P142LL-27478 Coax, 50 Ohm						
<b>PE3M0143</b>	0.195" dia.				dB/100ft	W
12"	18"	24"	36"	48"	60"	Custom Len.
\$540.75	\$549.23	\$557.70	\$574.66	\$591.62	\$608.57	See Web

\*Coax Performance at 1 GHz Notes: Cable assembly max frequency may be lower than connector or coax max frequency

For our complete selection of cable assemblies, please visit our website

**SMA FEMALE TO N FEMALE BULKHEAD**

SEE MOUNTING HOLE SECTION ON PAGE 369



**Low Loss Flexible Cable Assemblies**

**PE-P142LL Coax, 50 Ohm**

Part No. <b>PE3C3159</b>	Cable Dia.	Attn. @ 1 GHz	Power @ 1 GHz
1 piece price shown. See web or call for volume pricing.			
12"	0.195" dia.	10 dB/100ft	W
24"	60"	50CM	Custom Len.
\$196.36	\$212.12	\$227.89	\$243.65
\$259.41	\$206.46	See Web	

98

**PE-P142LL-27478 Coax, 50 Ohm**

Part No. <b>PE3M0142</b>	Cable Dia.	Attn. @ 1 GHz	Power @ 1 GHz
1 piece price shown. See web or call for volume pricing.			
12"	0.195" dia.	dB/100ft	W
18"	60"	50CM	Custom Len.
\$512.91	\$521.39	\$529.87	\$546.83
\$563.78	\$580.74	See Web	

99

**SMA FEMALE TO QMA MALE**



**Standard Flexible Cable Assemblies**

**RG58C/U Coax, 50 Ohm**

Part No. <b>PE38277</b>	Cable Dia.	Attn. @ 1 GHz	Power @ 1 GHz
1 piece price shown. See web or call for volume pricing.			
12"	0.195" dia.	20 dB/100ft	44 W
24"	60"	72"	Custom Len.
\$55.06	\$60.27	\$56.56	\$57.28
\$58.00	\$58.71	See Web	

1

**RG316/U Coax, 50 Ohm**

Part No. <b>PE38276</b>	Cable Dia.	Attn. @ 1 GHz	Power @ 1 GHz
1 piece price shown. See web or call for volume pricing.			
12"	0.098" dia.	38 dB/100ft	160 W
24"	60"	72"	Custom Len.
\$68.61	\$71.73	\$69.29	\$72.19
\$75.08	\$77.96	See Web	

2

**SMA FEMALE TO SMA MALE RIGHT ANGLE**



**Low Loss Flexible Cable Assemblies**

**PE-P142LL-27478 Coax, 50 Ohm**

Part No. <b>PE3M0137</b>	Cable Dia.	Attn. @ 1 GHz	Power @ 1 GHz
1 piece price shown. See web or call for volume pricing.			
12"	0.195" dia.	dB/100ft	W
18"	60"	50CM	Custom Len.
\$514.77	\$523.25	\$531.73	\$548.69
\$565.64	\$582.60	See Web	

3

**Standard Flexible Cable Assemblies**

**RG174A/U Coax, 50 Ohm**

Part No. <b>PE3W03981</b>	Cable Dia.	Attn. @ 1 GHz	Power @ 1 GHz
1 piece price shown. See web or call for volume pricing.			
12"	0.110" dia.	32 dB/100ft	17 W
24"	60"	50CM	Custom Len.
\$48.67	\$49.23	\$49.79	\$50.35
\$50.91	\$49.02	See Web	

4

**SMA FEMALE TO SMA FEMALE**



**Low Loss Flexible Cable Assemblies**

**LMR-100A-PVC Coax, 50 Ohm**

Part No. <b>PE3C0045</b>	Cable Dia.	Attn. @ 1 GHz	Power @ 1 GHz
1 piece price shown. See web or call for volume pricing.			
12"	0.110" dia.	24 dB/100ft	W
24"	60"	-	Custom Len.
\$53.39	\$54.15	\$54.90	\$55.66
\$60.76	-	See Web	

5

**PE-P142LL Coax, 50 Ohm**

Part No. <b>PE3C1239</b>	Cable Dia.	Attn. @ 1 GHz	Power @ 1 GHz
1 piece price shown. See web or call for volume pricing.			
12"	0.195" dia.	10 dB/100ft	W
24"	60"	50CM	Custom Len.
\$182.99	\$199.23	\$215.47	\$231.70
\$247.94	\$193.40	See Web	

6

**PE-P142LL-27478 Coax, 50 Ohm**

Part No. <b>PE3M0135</b>	Cable Dia.	Attn. @ 1 GHz	Power @ 1 GHz
1 piece price shown. See web or call for volume pricing.			
12"	0.195" dia.	dB/100ft	W
18"	60"	50CM	Custom Len.
\$481.38	\$489.86	\$498.34	\$515.29
\$532.25	\$549.21	See Web	

7

**Standard Formable Cable Assemblies**

**PE-SR047FL Coax, 50 Ohm**

Part No. <b>PE34833</b>	Cable Dia.	Attn. @ 1 GHz	Power @ 1 GHz
1 piece price shown. See web or call for volume pricing.			
6"	0.047" dia.	36 dB/100ft	32 W
12"	36"	48"	Custom Len.
\$111.03	\$106.46	\$110.14	\$123.09
\$121.20	\$128.57	See Web	

8

**PE-SR402FL Coax, 50 Ohm**

Part No. <b>PE33964</b>	Cable Dia.	Attn. @ 1 GHz	Power @ 1 GHz
1 piece price shown. See web or call for volume pricing.			
6"	" dia.	12 dB/100ft	450 W
12"	36"	48"	Custom Len.
\$62.05	\$62.05	\$65.82	\$69.58
\$77.12	\$84.67	See Web	

9

**PE-SR405FL Coax, 50 Ohm**

Part No. <b>PE34292</b>	Cable Dia.	Attn. @ 1 GHz	Power @ 1 GHz
1 piece price shown. See web or call for volume pricing.			
6"	" dia.	23 dB/100ft	130 W
12"	36"	48"	Custom Len.
\$87.63	\$87.63	\$93.43	\$99.22
\$110.82	\$122.41	See Web	

10

**Standard Flexible Cable Assemblies**

**RG58C/U Coax, 50 Ohm**

Part No. <b>PE33547</b>	Cable Dia.	Attn. @ 1 GHz	Power @ 1 GHz
1 piece price shown. See web or call for volume pricing.			
12"	0.195" dia.	20 dB/100ft	44 W
24"	60"	-	Custom Len.
\$63.12	\$59.18	\$59.92	\$65.60
\$61.39	-	See Web	

11

**RG142B/U Coax, 50 Ohm**

Part No. <b>PE3578</b>	Cable Dia.	Attn. @ 1 GHz	Power @ 1 GHz
1 piece price shown. See web or call for volume pricing.			
12"	0.195" dia.	13 dB/100ft	650 W
24"	60"	-	Custom Len.
\$47.49	\$53.22	\$58.95	\$69.88
\$70.41	-	See Web	

12

**RG174A/U Coax, 50 Ohm**

Part No. <b>PE33120</b>	Cable Dia.	Attn. @ 1 GHz	Power @ 1 GHz
1 piece price shown. See web or call for volume pricing.			
12"	0.110" dia.	32 dB/100ft	17 W
24"	60"	-	Custom Len.
\$57.86	\$63.07	\$58.72	\$64.26
\$59.61	-	See Web	

13

**RG223/U Coax, 50 Ohm**

Part No. <b>PE33254</b>	Cable Dia.	Attn. @ 1 GHz	Power @ 1 GHz
1 piece price shown. See web or call for volume pricing.			
12"	0.210" dia.	13 dB/100ft	53 W
24"	60"	-	Custom Len.
\$42.45	\$45.09	\$47.74	\$54.53
\$53.06	-	See Web	

14

**RG316/U Coax, 50 Ohm**

Part No. <b>PE33047</b>	Cable Dia.	Attn. @ 1 GHz	Power @ 1 GHz
1 piece price shown. See web or call for volume pricing.			
12"	0.102" dia.	38 dB/100ft	W
24"	60"	-	Custom Len.
\$63.96	\$67.09	\$66.11	\$73.52
\$76.71	-	See Web	

15

**Standard Semi-Rigid Cable Assemblies**

**PE-020SR Coax, 50 Ohm**

Part No. <b>PE34917</b>	Cable Dia.	Attn. @ 1 GHz	Power @ 1 GHz
1 piece price shown. See web or call for volume pricing.			
6"	" dia.	85 dB/100ft	3 W
12"	36"	48"	Custom Len.
\$171.22	\$181.49	\$180.28	\$189.35
\$207.49	\$225.64	See Web	

16

**PE-034SR Coax, 50 Ohm**

Part No. <b>PE34405</b>	Cable Dia.	Attn. @ 1 GHz	Power @ 1 GHz
1 piece price shown. See web or call for volume pricing.			
6"	" dia.	60 dB/100ft	10 W
12"	36"	48"	Custom Len.
\$151.25	\$157.22	\$154.46	\$160.61
\$172.89	\$185.18	See Web	

17

**PE-047SR Coax, 50 Ohm**

Part No. <b>PE3758</b>	Cable Dia.	Attn. @ 1 GHz	Power @ 1 GHz
1 piece price shown. See web or call for volume pricing.			
6"	" dia.	40 dB/100ft	32 W
12"	36"	48"	Custom Len.
\$106.34	\$111.71	\$112.53	\$122.78
\$133.84	\$138.12	See Web	

18

**PE-SR047AL Coax, 50 Ohm**

Part No. <b>PE34835</b>	Cable Dia.	Attn. @ 1 GHz	Power @ 1 GHz
1 piece price shown. See web or call for volume pricing.			
6"	0.047" dia.	41 dB/100ft	32 W
12"	36"	48"	Custom Len.
\$111.90	\$106.22	\$110.75	\$115.29
\$124.37	\$133.44	See Web	

19

**PE-SR402AL Coax, 50 Ohm**

Part No. <b>PE34836</b>	Cable Dia.	Attn. @ 1 GHz	Power @ 1 GHz
1 piece price shown. See web or call for volume pricing.			
6"	0.141" dia.	13 dB/100ft	450 W
12"	36"	48"	Custom Len.
\$63.97	\$67.81	\$68.68	\$73.37
\$82.80	\$92.20	See Web	

20

**PE-SR405AL Coax, 50 Ohm**

Part No. <b>PE34834</b>	Cable Dia.	Attn. @ 1 GHz	Power @ 1 GHz
1 piece price shown. See web or call for volume pricing.			
6"	" dia.	23 dB/100ft	130 W
12"	36"	48"	Custom Len.
\$73.01	\$81.84	\$81.41	\$85.54
\$93.95	\$102.29	See Web	

21

**RG401/U Coax, 50 Ohm**

Part No. <b>PE3521</b>	Cable Dia.	Attn. @ 1 GHz	Power @ 1 GHz
1 piece price shown. See web or call for volume pricing.			
6"	" dia.	8 dB/100ft	870 W
12"	36"	48"	Custom Len.
\$109.20	\$109.20	\$120.18	\$131.14
\$153.09	\$175.05	See Web	

22

**RG402/U Coax, 50 Ohm**

Part No. <b>PE3931</b>	Cable Dia.	Attn. @ 1 GHz	Power @ 1 GHz
1 piece price shown. See web or call for volume pricing.			
6"	" dia.	12 dB/100ft	650 W
12"	36"	48"	Custom Len.
\$61.71	\$65.51	\$69.42	\$69.10
\$76.41	\$83.71	See Web	

23

**RG405/U Coax, 50 Ohm**

Part No. <b>PE3109</b>	Cable Dia.	Attn. @ 1 GHz	Power @ 1 GHz
1 piece price shown. See web or call for volume pricing.			
6"	" dia.	22 dB/100ft	130 W
12"	36"	48"	Custom Len.
\$62.71	\$62.71	\$66.15	\$69.58
\$76.45	\$83.33	See Web	

24

**Standard Flexible Cable Assemblies**

**RG62A/U Coax, 93 Ohm**

Part No. <b>PE3424</b>	Cable Dia.	Attn. @ 1 GHz	Power @ 1 GHz
1 piece price shown. See web or call for volume pricing.			
12"	0.242" dia.	13 dB/100ft	77 W
24"	60"	-	Custom Len.
\$63.64	\$64.90	\$66.15	\$67.42
\$68.69	-	See Web	

25

**SMA FEMALE TO SMA FEMALE BULKHEAD**

SEE MOUNTING HOLE SECTION ON PAGE 369



**Low Loss Flexible Cable Assemblies**

For our complete selection of cable assemblies, please visit our website

Cable Assemblies

See Our Website For Current Pricing & Real-Time Stock Availability!

PE-P142LL-27478 Coax, 50 Ohm						
Part No. <a href="#">PE3M0136</a>	1 piece price shown. See web or call for volume pricing.			Cable Dia. 0.195" dia.	Attn. @ 1 GHz dB/100ft	Power @ 1 GHz W
12"	18"	24"	36"	48"	60"	Custom Len.
\$514.03	\$522.51	\$530.99	\$547.95	\$564.90	\$581.86	See Web
<b>SMA FEMALE TO SSMC PLUG</b>						
<b>Flexible Cable Assemblies</b>						
LMR-100A-PVC Coax, 50 Ohm						
Part No. <a href="#">PE3W06055</a>	1 piece price shown. See web or call for volume pricing.			Cable Dia. 0.110" dia.	Attn. @ 1 GHz 24 dB/100ft	Power @ 1 GHz W
12"	24"	36"	48"	60"	50CM	Custom Len.
\$44.50	\$45.22	\$45.94	\$46.67	\$47.40	\$44.96	See Web
<b>Low Loss Flexible Cable Assemblies</b>						
LMR-100A-PVC Coax, 50 Ohm						
Part No. <a href="#">PE3C4426</a>	1 piece price shown. See web or call for volume pricing.			Cable Dia. 0.110" dia.	Attn. @ 1 GHz 24 dB/100ft	Power @ 1 GHz W
6"	12"	18"	24"	36"	48"	Custom Len.
\$54.27	\$54.64	\$60.48	\$55.38	\$56.12	\$56.85	See Web
<b>Standard Flexible Cable Assemblies</b>						
RG178B/U Coax, 50 Ohm						
Part No. <a href="#">PE3C4393</a>	1 piece price shown. See web or call for volume pricing.			Cable Dia. 0.072" dia.	Attn. @ 1 GHz 44 dB/100ft	Power @ 1 GHz 55 W
6"	12"	18"	24"	36"	48"	Custom Len.
\$73.00	\$80.82	\$73.94	\$74.40	\$75.34	\$76.26	See Web
<b>Standard Flexible Cable Assemblies</b>						
RG316/U Coax, 50 Ohm						
Part No. <a href="#">PE3C4409</a>	1 piece price shown. See web or call for volume pricing.			Cable Dia. 0.098" dia.	Attn. @ 1 GHz 58 dB/100ft	Power @ 1 GHz 160 W
6"	12"	18"	24"	36"	48"	Custom Len.
\$64.85	\$66.27	\$67.67	\$69.05	\$71.87	\$74.66	See Web
<b>SMA FEMALE TO SSMC PLUG RIGHT ANGLE</b>						
<b>Low Loss Flexible Cable Assemblies</b>						
LMR-100A-PVC Coax, 50 Ohm						
Part No. <a href="#">PE3C4427</a>	1 piece price shown. See web or call for volume pricing.			Cable Dia. 0.110" dia.	Attn. @ 1 GHz 24 dB/100ft	Power @ 1 GHz W
6"	12"	18"	24"	36"	48"	Custom Len.
\$50.84	\$51.21	\$54.66	\$51.95	\$52.69	\$53.43	See Web
<b>Standard Flexible Cable Assemblies</b>						
RG178B/U Coax, 50 Ohm						
Part No. <a href="#">PE3C4464</a>	1 piece price shown. See web or call for volume pricing.			Cable Dia. 0.072" dia.	Attn. @ 1 GHz 44 dB/100ft	Power @ 1 GHz 55 W
6"	12"	18"	24"	36"	48"	Custom Len.
\$64.58	\$65.06	\$65.53	\$65.99	\$66.92	\$67.86	See Web
<b>Standard Flexible Cable Assemblies</b>						
RG316/U Coax, 50 Ohm						
Part No. <a href="#">PE3C4410</a>	1 piece price shown. See web or call for volume pricing.			Cable Dia. 0.098" dia.	Attn. @ 1 GHz 58 dB/100ft	Power @ 1 GHz 160 W
6"	12"	18"	24"	36"	48"	Custom Len.
\$61.43	\$62.83	\$64.24	\$65.62	\$68.44	\$71.23	See Web
<b>Standard Flexible Cable Assemblies</b>						
RG316-DS Coax, 50 Ohm						
Part No. <a href="#">PE3C4473</a>	1 piece price shown. See web or call for volume pricing.			Cable Dia. 0.114" dia.	Attn. @ 1 GHz 9 dB/100ft	Power @ 1 GHz 85 W
6"	12"	18"	24"	36"	48"	Custom Len.
\$60.43	\$61.84	\$63.26	\$64.67	\$67.49	\$70.32	See Web
<b>SMA FEMALE TO TNC MALE</b>						
<b>Low Loss Flexible Cable Assemblies</b>						
LMR-100A-PVC Coax, 50 Ohm						
Part No. <a href="#">PE3W00825</a>	1 piece price shown. See web or call for volume pricing.			Cable Dia. 0.110" dia.	Attn. @ 1 GHz 24 dB/100ft	Power @ 1 GHz W
12"	24"	36"	48"	60"	50CM	Custom Len.
\$52.83	\$53.57	\$54.31	\$55.05	\$55.78	\$53.31	See Web
<b>PE-P142LL Coax, 50 Ohm</b>						
Part No. <a href="#">PE3C3205</a>	1 piece price shown. See web or call for volume pricing.			Cable Dia. 0.195" dia.	Attn. @ 1 GHz 10 dB/100ft	Power @ 1 GHz W
12"	24"	36"	48"	60"	50CM	Custom Len.
\$172.82	\$189.06	\$205.29	\$221.53	\$237.76	\$183.22	See Web
<b>PE-P142LL-27478 Coax, 50 Ohm</b>						
Part No. <a href="#">PE3M0138</a>	1 piece price shown. See web or call for volume pricing.			Cable Dia. 0.195" dia.	Attn. @ 1 GHz dB/100ft	Power @ 1 GHz W
12"	18"	24"	36"	48"	60"	Custom Len.
\$434.06	\$442.54	\$451.02	\$467.98	\$484.93	\$501.89	See Web
<b>SMA FEMALE TO TNC MALE RIGHT ANGLE</b>						

Low Loss Flexible Cable Assemblies						
PE-P142LL-27478 Coax, 50 Ohm						
Part No. <a href="#">PE3M0140</a>	1 piece price shown. See web or call for volume pricing.			Cable Dia. 0.195" dia.	Attn. @ 1 GHz dB/100ft	Power @ 1 GHz W
12"	18"	24"	36"	48"	60"	Custom Len.
\$540.75	\$549.23	\$557.70	\$574.66	\$591.62	\$608.57	See Web
<b>SMA FEMALE TO TNC FEMALE BULKHEAD</b>						
SEE MOUNTING HOLE SECTION ON PAGE 369						
Low Loss Flexible Cable Assemblies						
PE-P142LL-27478 Coax, 50 Ohm						
Part No. <a href="#">PE3M0139</a>	1 piece price shown. See web or call for volume pricing.			Cable Dia. 0.195" dia.	Attn. @ 1 GHz dB/100ft	Power @ 1 GHz W
12"	18"	24"	36"	48"	60"	Custom Len.
\$512.91	\$521.39	\$529.87	\$546.83	\$563.78	\$580.74	See Web
<b>SMA FEMALE BULKHEAD TO SMA FEMALE BULKHEAD</b>						
SEE MOUNTING HOLE SECTION ON PAGE 369						
Standard Flexible Cable Assemblies						
M17/113-RG316-27478 Coax, 50 Ohm						
Part No. <a href="#">PE3M0095</a>	1 piece price shown. See web or call for volume pricing.			Cable Dia. 0.098" dia.	Attn. @ 1 GHz dB/100ft	Power @ 1 GHz W
6"	8"	12"	16"	18"	24"	Custom Len.
\$186.41	\$186.73	\$187.40	\$188.07	\$188.41	\$189.41	See Web
<b>Standard Flexible Cable Assemblies</b>						
M17/119-RG174-0XDS2 Coax, 50 Ohm						
Part No. <a href="#">PE3M0110</a>	1 piece price shown. See web or call for volume pricing.			Cable Dia. 0.110" dia.	Attn. @ 1 GHz dB/100ft	Power @ 1 GHz W
6"	8"	12"	16"	18"	24"	Custom Len.
\$185.79	\$185.92	\$186.18	\$186.44	\$186.56	\$186.96	See Web
<b>SMA FEMALE BULKHEAD TO TNC MALE</b>						
SEE MOUNTING HOLE SECTION ON PAGE 369						
Standard Flexible Cable Assemblies						
M17/113-RG316-27478 Coax, 50 Ohm						
Part No. <a href="#">PE3M0098</a>	1 piece price shown. See web or call for volume pricing.			Cable Dia. 0.098" dia.	Attn. @ 1 GHz dB/100ft	Power @ 1 GHz W
6"	8"	12"	16"	18"	24"	Custom Len.
\$187.37	\$187.70	\$188.37	\$189.04	\$189.38	\$190.38	See Web
<b>Standard Flexible Cable Assemblies</b>						
M17/119-RG174-0XDS2 Coax, 50 Ohm						
Part No. <a href="#">PE3M0113</a>	1 piece price shown. See web or call for volume pricing.			Cable Dia. 0.110" dia.	Attn. @ 1 GHz dB/100ft	Power @ 1 GHz W
6"	8"	12"	16"	18"	24"	Custom Len.
\$186.76	\$186.87	\$187.14	\$187.39	\$187.54	\$187.92	See Web
<b>SMA FEMALE BULKHEAD TO MCX PLUG RIGHT ANGLE</b>						
SEE MOUNTING HOLE SECTION ON PAGE 369						
Precision Formable Cable Assemblies						
PE-SR405FL Coax, 50 Ohm						
Part No. <a href="#">PE39421</a>	1 piece price shown. See web or call for volume pricing.			Cable Dia. " dia.	Attn. @ 1 GHz dB/100ft	Power @ 1 GHz 130 W
6"	9"	12"	18"	24"	-	Custom Len.
\$43.35	\$39.40	\$43.35	\$49.14	\$54.94	-	See Web
<b>Standard Formable Cable Assemblies</b>						
PE-SR405FLJ Coax, 50 Ohm						
Part No. <a href="#">PE39435</a>	1 piece price shown. See web or call for volume pricing.			Cable Dia. 0.105" dia.	Attn. @ 1 GHz 23 dB/100ft	Power @ 1 GHz 122 W
6"	9"	12"	18"	24"	-	Custom Len.
\$38.12	\$36.04	\$38.12	\$42.61	\$47.10	-	See Web
<b>SMA FEMALE BULKHEAD TO MMCX PLUG</b>						
SEE MOUNTING HOLE SECTION ON PAGE 369						
Standard Flexible Cable Assemblies						
RG316/U Coax, 50 Ohm						
Part No. <a href="#">PE35575</a>	1 piece price shown. See web or call for volume pricing.			Cable Dia. 0.098" dia.	Attn. @ 1 GHz 38 dB/100ft	Power @ 1 GHz 160 W
12"	24"	36"	48"	60"	-	Custom Len.
\$58.15	\$61.28	\$64.40	\$63.53	\$66.41	-	See Web
<b>SMA FEMALE BULKHEAD TO MMCX PLUG RIGHT ANGLE</b>						
SEE MOUNTING HOLE SECTION ON PAGE 369						
Precision Formable Cable Assemblies						
PE-SR405FL Coax, 50 Ohm						

\*Coax Performance at 1 GHz Notes: Cable assembly max frequency may be lower than connector or coax max frequency

For our complete selection of cable assemblies, please visit our website

Part No. <a href="#">PE39422</a>	Cable Dia.	Attn. @ 1 GHz	Power @ 1 GHz
1 piece price shown. See web or call for volume pricing.			
6"	9"	12"	18"
\$43.13	\$40.37	\$43.13	\$48.93
		24"	24"
		\$54.72	-
		-	Custom Len.
		-	See Web

**Standard Formable Cable Assemblies**

**PE-SR405FLJ Coax, 50 Ohm**

Part No. <a href="#">PE39436</a>	Cable Dia.	Attn. @ 1 GHz	Power @ 1 GHz
1 piece price shown. See web or call for volume pricing.			
6"	9"	12"	18"
\$58.53	\$56.45	\$58.53	\$63.02
		24"	24"
		\$67.50	-
		-	Custom Len.
		-	See Web

**Standard Flexible Cable Assemblies**

**RG174A/U Coax, 50 Ohm**

Part No. <a href="#">PE34786</a>	Cable Dia.	Attn. @ 1 GHz	Power @ 1 GHz
1 piece price shown. See web or call for volume pricing.			
12"	24"	36"	48"
\$58.17	\$58.72	\$59.27	\$59.84
		60"	60"
		\$60.39	\$60.39
		\$58.54	-
		-	Custom Len.
		-	See Web

**RG178B/U Coax, 50 Ohm**

Part No. <a href="#">PE3C3821</a>	Cable Dia.	Attn. @ 1 GHz	Power @ 1 GHz
1 piece price shown. See web or call for volume pricing.			
12"	24"	36"	48"
\$60.66	\$61.69	\$62.71	\$63.74
		60"	60"
		\$64.77	\$64.77
		\$61.31	-
		-	Custom Len.
		-	See Web

**RG188-DS Coax, 50 Ohm**

Part No. <a href="#">PE3W00934</a>	Cable Dia.	Attn. @ 1 GHz	Power @ 1 GHz
1 piece price shown. See web or call for volume pricing.			
12"	24"	36"	48"
\$69.07	\$72.49	\$75.91	\$79.33
		60"	60"
		\$82.75	\$82.75
		Call	-
		-	Custom Len.
		-	See Web

**RG316/U Coax, 50 Ohm**

Part No. <a href="#">PE3C1081</a>	Cable Dia.	Attn. @ 1 GHz	Power @ 1 GHz
1 piece price shown. See web or call for volume pricing.			
12"	24"	36"	48"
\$55.41	\$58.44	\$61.48	\$64.51
		60"	60"
		\$67.55	\$67.55
		Call	-
		-	Custom Len.
		-	See Web

Part No. <a href="#">PE34686</a>	Cable Dia.	Attn. @ 1 GHz	Power @ 1 GHz
1 piece price shown. See web or call for volume pricing.			
12"	24"	36"	48"
\$59.05	\$62.16	\$65.29	\$65.43
		60"	60"
		\$71.78	\$71.78
		-	-
		-	Custom Len.
		-	See Web

**SMA FEMALE BULKHEAD TO N MALE**

SEE MOUNTING HOLE SECTION ON PAGE 369



**Low Loss Flexible Cable Assemblies**

**PE-P142LL-27478 Coax, 50 Ohm**

Part No. <a href="#">PE3M0149</a>	Cable Dia.	Attn. @ 1 GHz	Power @ 1 GHz
1 piece price shown. See web or call for volume pricing.			
12"	18"	24"	36"
\$458.37	\$466.84	\$475.32	\$492.28
		48"	60"
		\$509.23	\$526.19
		-	Custom Len.
		-	See Web

**PE-P160LL-27478 Coax, 50 Ohm**

Part No. <a href="#">PE3M0194</a>	Cable Dia.	Attn. @ 1 GHz	Power @ 1 GHz
1 piece price shown. See web or call for volume pricing.			
8"	12"	18"	24"
\$442.62	\$447.52	\$454.87	\$462.22
		30"	36"
		\$469.58	\$476.92
		-	Custom Len.
		-	See Web

**SMA FEMALE BULKHEAD TO N MALE RIGHT ANGLE**

SEE MOUNTING HOLE SECTION ON PAGE 369



**Low Loss Flexible Cable Assemblies**

**PE-P142LL-27478 Coax, 50 Ohm**

Part No. <a href="#">PE3M0151</a>	Cable Dia.	Attn. @ 1 GHz	Power @ 1 GHz
1 piece price shown. See web or call for volume pricing.			
12"	18"	24"	36"
\$573.40	\$581.88	\$590.36	\$607.32
		48"	60"
		\$624.27	\$641.23
		-	Custom Len.
		-	See Web

**PE-P160LL-27478 Coax, 50 Ohm**

Part No. <a href="#">PE3M0196</a>	Cable Dia.	Attn. @ 1 GHz	Power @ 1 GHz
1 piece price shown. See web or call for volume pricing.			
8"	12"	18"	24"
\$540.67	\$545.58	\$552.92	\$560.28
		30"	36"
		\$567.63	\$574.98
		-	Custom Len.
		-	See Web

**SMA FEMALE BULKHEAD TO N FEMALE BULKHEAD**

SEE MOUNTING HOLE SECTION ON PAGE 369



**Low Loss Flexible Cable Assemblies**

**PE-P142LL-27478 Coax, 50 Ohm**

Part No. <a href="#">PE3M0150</a>	Cable Dia.	Attn. @ 1 GHz	Power @ 1 GHz
1 piece price shown. See web or call for volume pricing.			
12"	18"	24"	36"
\$545.57	\$554.05	\$562.52	\$579.48
		48"	60"
		\$596.44	\$613.39
		-	Custom Len.
		-	See Web

**PE-P160LL-27478 Coax, 50 Ohm**

Part No. <a href="#">PE3M0195</a>	Cable Dia.	Attn. @ 1 GHz	Power @ 1 GHz
1 piece price shown. See web or call for volume pricing.			
8"	12"	18"	24"
\$544.61	\$549.52	\$556.86	\$564.22
		30"	36"
		\$571.56	\$578.92
		-	Custom Len.
		-	See Web

**SMA FEMALE BULKHEAD TO SMA MALE**

SEE MOUNTING HOLE SECTION ON PAGE 369



**Standard Formable Cable Assemblies**

**PE-SR402FL Coax, 50 Ohm**

Part No. <a href="#">PE39427</a>	Cable Dia.	Attn. @ 1 GHz	Power @ 1 GHz
1 piece price shown. See web or call for volume pricing.			
6"	9"	12"	18"
\$52.44	\$50.47	\$52.44	\$56.62
		24"	24"
		\$60.79	-
		-	Custom Len.
		-	See Web

Part No. <a href="#">PE3468</a>	Cable Dia.	Attn. @ 1 GHz	Power @ 1 GHz
1 piece price shown. See web or call for volume pricing.			
6"	12"	18"	24"
\$59.25	\$63.17	\$67.21	\$67.13
		36"	48"
		\$74.67	\$82.21
		-	Custom Len.
		-	See Web

**PE-SR402FLJ Coax, 50 Ohm**

Part No. <a href="#">PE3W04417</a>	Cable Dia.	Attn. @ 1 GHz	Power @ 1 GHz
1 piece price shown. See web or call for volume pricing.			
12"	24"	36"	48"
\$49.05	\$57.93	\$66.82	\$75.70
		60"	60"
		\$84.58	\$84.58
		\$54.73	-
		-	Custom Len.
		-	See Web

**Standard Flexible Cable Assemblies**

**RG316-DS Coax, 50 Ohm**

Part No. <a href="#">PE3973</a>	Cable Dia.	Attn. @ 1 GHz	Power @ 1 GHz
1 piece price shown. See web or call for volume pricing.			
6"	12"	18"	24"
\$53.35	\$54.87	\$56.43	\$58.00
		36"	48"
		\$57.58	\$60.49
		\$60.49	-
		-	Custom Len.
		-	See Web

**PE-P141EAM Coax, 50 Ohm**

Part No. <a href="#">PE3CA1038</a>	Cable Dia.	Attn. @ 1 GHz	Power @ 1 GHz
1 piece price shown. See web or call for volume pricing.			
12"	24"	36"	50CM
\$79.67	\$101.60	\$123.54	\$83.67
		100CM	115.80
		-	-
		-	Custom Len.
		-	See Web

**SMA FEMALE BULKHEAD TO SMA MALE RIGHT ANGLE**

SEE MOUNTING HOLE SECTION ON PAGE 369



**Flexible Cable Assemblies**

**LMR-195 Coax, 50 Ohm**

Part No. <a href="#">PE3W05962</a>	Cable Dia.	Attn. @ 1 GHz	Power @ 1 GHz
1 piece price shown. See web or call for volume pricing.			
12"	24"	36"	48"
\$33.03	\$33.67	\$34.32	\$34.96
		60"	60"
		\$35.61	\$33.44
		-	Custom Len.
		-	See Web

**Low Loss Flexible Cable Assemblies**

**PE-P142LL-27478 Coax, 50 Ohm**

Part No. <a href="#">PE3M0145</a>	Cable Dia.	Attn. @ 1 GHz	Power @ 1 GHz
1 piece price shown. See web or call for volume pricing.			
12"	18"	24"	36"
\$547.43	\$555.91	\$564.38	\$581.34
		48"	60"
		\$598.30	\$615.25
		-	Custom Len.
		-	See Web

**PE-P160LL-27478 Coax, 50 Ohm**

Part No. <a href="#">PE3M0190</a>	Cable Dia.	Attn. @ 1 GHz	Power @ 1 GHz
1 piece price shown. See web or call for volume pricing.			
8"	12"	18"	24"
\$548.55	\$553.44	\$560.80	\$568.15
		30"	36"
		\$575.50	\$582.85
		-	Custom Len.
		-	See Web

**Standard Formable Cable Assemblies**

**PE-SR405FLJ Coax, 50 Ohm**

Part No. <a href="#">PE39434</a>	Cable Dia.	Attn. @ 1 GHz	Power @ 1 GHz
1 piece price shown. See web or call for volume pricing.			
6"	9"	12"	18"
\$52.84	\$54.64	\$54.64	\$60.94
		24"	24"
		\$62.10	-
		-	Custom Len.
		-	See Web

**SMA FEMALE BULKHEAD TO SMA FEMALE**

SEE MOUNTING HOLE SECTION ON PAGE 369



**Standard Flexible Cable Assemblies**

**RG316/U Coax, 50 Ohm**

Part No. <a href="#">PE3W07334</a>	Cable Dia.	Attn. @ 1 GHz	Power @ 1 GHz
1 piece price shown. See web or call for volume pricing.			
12"	24"	36"	48"
\$49.30	\$52.57	\$55.86	\$59.14
		60"	60"
		\$62.42	\$51.40
		-	Custom Len.
		-	See Web

**SMA FEMALE BULKHEAD TO SMA FEMALE BULKHEAD**

SEE MOUNTING HOLE SECTION ON PAGE 369



**Low Loss Flexible Cable Assemblies**

**PE-P142LL-27478 Coax, 50 Ohm**

Part No. <a href="#">PE3M0144</a>	Cable Dia.	Attn. @ 1 GHz	Power @ 1 GHz
1 piece price shown. See web or call for volume pricing.			
12"	18"	24"	36"
\$546.68	\$555.16	\$563.64	\$580.59
		48"	60"
		\$597.55	\$614.51
		-	Custom Len.
		-	See Web

**PE-P160LL-27478 Coax, 50 Ohm**

Part No. <a href="#">PE3M0189</a>	Cable Dia.	Attn. @ 1 GHz	Power @ 1 GHz
1 piece price shown. See web or call for volume pricing.			
8"	12"	18"	24"
\$544.61	\$549.52	\$556.86	\$564.22
		30"	36"
		\$571.56	\$578.92
		-	Custom Len.</

For our complete selection of cable assemblies, please visit our website

Cable Assemblies  
See Our Website For Current Pricing & Real-Time Stock Availability!

PE-P160LL Coax, 50 Ohm						
Part No.	PE3C5247	Cable Dia.	Attn. @ 1 GHz	Power @ 1 GHz		
1 piece price shown. See web or call for volume pricing.						
12"	24"	36"	48"	60"	50CM	Custom Len.
\$239.46	\$284.75	\$276.68	\$297.07	\$317.48	\$248.93	See Web
Standard Formable Cable Assemblies						
PE-SR401FL Coax, 50 Ohm						
Part No.	PE3794	Cable Dia.	Attn. @ 1 GHz	Power @ 1 GHz		
1 piece price shown. See web or call for volume pricing.						
6"	12"	18"	24"	36"	48"	Custom Len.
\$107.82	\$122.24	\$122.76	\$130.26	\$145.21	\$160.15	See Web
PE-SR402FL Coax, 50 Ohm						
Part No.	PE33864	Cable Dia.	Attn. @ 1 GHz	Power @ 1 GHz		
1 piece price shown. See web or call for volume pricing.						
6"	12"	18"	24"	36"	48"	Custom Len.
\$71.62	\$71.62	\$75.80	\$79.97	\$88.33	\$96.68	See Web
PE-SR405FL Coax, 50 Ohm						
Part No.	PE34070	Cable Dia.	Attn. @ 1 GHz	Power @ 1 GHz		
1 piece price shown. See web or call for volume pricing.						
6"	12"	18"	24"	36"	48"	Custom Len.
\$76.84	\$76.84	\$87.13	\$87.54	\$98.24	\$108.93	See Web
Standard Flexible Cable Assemblies						
RG58C/U Coax, 50 Ohm						
Part No.	PE35404	Cable Dia.	Attn. @ 1 GHz	Power @ 1 GHz		
1 piece price shown. See web or call for volume pricing.						
12"	24"	36"	48"	60"	-	Custom Len.
\$56.29	\$57.03	\$57.76	\$64.41	\$59.22	-	See Web
RG174A/U Coax, 50 Ohm						
Part No.	PE33382	Cable Dia.	Attn. @ 1 GHz	Power @ 1 GHz		
1 piece price shown. See web or call for volume pricing.						
12"	24"	36"	48"	60"	-	Custom Len.
\$52.91	\$53.44	\$53.92	\$54.45	\$54.94	-	See Web
RG178B/U Coax, 50 Ohm						
Part No.	PE33084	Cable Dia.	Attn. @ 1 GHz	Power @ 1 GHz		
1 piece price shown. See web or call for volume pricing.						
12"	24"	36"	48"	60"	-	Custom Len.
\$70.88	\$71.85	\$77.25	\$78.37	\$74.71	-	See Web
RG316/U Coax, 50 Ohm						
Part No.	PE33158	Cable Dia.	Attn. @ 1 GHz	Power @ 1 GHz		
1 piece price shown. See web or call for volume pricing.						
12"	24"	36"	48"	60"	-	Custom Len.
\$58.56	\$65.20	\$64.32	\$67.21	\$70.10	-	See Web
RG316-DS Coax, 50 Ohm						
Part No.	PE38184	Cable Dia.	Attn. @ 1 GHz	Power @ 1 GHz		
1 piece price shown. See web or call for volume pricing.						
12"	24"	36"	48"	60"	-	Custom Len.
\$64.54	\$71.54	\$70.36	\$77.98	\$81.16	-	See Web
Standard Semi-Rigid Cable Assemblies						
PE-SR405AL Coax, 50 Ohm						
Part No.	PE34071	Cable Dia.	Attn. @ 1 GHz	Power @ 1 GHz		
1 piece price shown. See web or call for volume pricing.						
6"	12"	18"	24"	36"	48"	Custom Len.
\$73.25	\$73.25	\$77.57	\$81.89	\$90.54	\$99.17	See Web
RG401/U Coax, 50 Ohm						
Part No.	PE3634	Cable Dia.	Attn. @ 1 GHz	Power @ 1 GHz		
1 piece price shown. See web or call for volume pricing.						
6"	12"	18"	24"	36"	48"	Custom Len.
\$110.99	\$121.61	\$132.30	\$142.91	\$164.22	\$185.52	See Web
RG402/U Coax, 50 Ohm						
Part No.	PE33518	Cable Dia.	Attn. @ 1 GHz	Power @ 1 GHz		
1 piece price shown. See web or call for volume pricing.						
6"	12"	18"	24"	36"	48"	Custom Len.
\$64.84	\$64.84	\$68.49	\$72.15	\$79.45	\$86.76	See Web
RG405/U Coax, 50 Ohm						
Part No.	PE33176	Cable Dia.	Attn. @ 1 GHz	Power @ 1 GHz		
1 piece price shown. See web or call for volume pricing.						
6"	12"	18"	24"	36"	48"	Custom Len.
\$72.82	\$77.20	\$76.25	\$79.69	\$86.56	\$93.43	See Web
SMA FEMALE BULKHEAD TO REVERSE POLARITY SMA MALE						
SEE MOUNTING HOLE SECTION ON PAGE 369						
Standard Flexible Cable Assemblies						
RG141A/U Coax, 50 Ohm						
Part No.	PE3W02965	Cable Dia.	Attn. @ 1 GHz	Power @ 1 GHz		
1 piece price shown. See web or call for volume pricing.						
12"	24"	36"	48"	60"	50CM	Custom Len.
\$70.05	\$77.43	\$84.80	\$92.18	\$99.56	\$74.78	See Web
SMA FEMALE BULKHEAD TO SMB PLUG RIGHT ANGLE						
SEE MOUNTING HOLE SECTION ON PAGE 369						
Low Loss Flexible Cable Assemblies						

PE-C100-LSZH Coax, 50 Ohm						
Part No.	PE3W00135	Cable Dia.	Attn. @ 1 GHz	Power @ 1 GHz		
1 piece price shown. See web or call for volume pricing.						
12"	24"	36"	48"	60"	50CM	Custom Len.
\$42.53	\$43.81	\$45.10	\$46.39	\$47.68	\$43.36	See Web
SMA FEMALE BULKHEAD TO SMP FEMALE						
SEE MOUNTING HOLE SECTION ON PAGE 369						
Standard Flexible Cable Assemblies						
PE-P086 Coax, 50 Ohm						
Part No.	PE3C5233	Cable Dia.	Attn. @ 1 GHz	Power @ 1 GHz		
1 piece price shown. See web or call for volume pricing.						
12"	24"	36"	48"	60"	50CM	Custom Len.
\$61.82	\$69.53	\$77.24	\$84.95	\$92.66	\$66.76	See Web
SMA FEMALE BULKHEAD TO SMP FEMALE RIGHT ANGLE						
SEE MOUNTING HOLE SECTION ON PAGE 369						
Low Loss Flexible Cable Assemblies						
LMR-100A-PVC Coax, 50 Ohm						
Part No.	PE3C3937	Cable Dia.	Attn. @ 1 GHz	Power @ 1 GHz		
1 piece price shown. See web or call for volume pricing.						
12"	24"	36"	48"	60"	50CM	Custom Len.
\$48.24	\$48.98	\$49.72	\$50.45	\$51.19	\$48.72	See Web
SMA FEMALE BULKHEAD TO SSMC PLUG						
SEE MOUNTING HOLE SECTION ON PAGE 369						
Low Loss Flexible Cable Assemblies						
LMR-100A-PVC Coax, 50 Ohm						
Part No.	PE3C4428	Cable Dia.	Attn. @ 1 GHz	Power @ 1 GHz		
1 piece price shown. See web or call for volume pricing.						
6"	12"	18"	24"	36"	48"	Custom Len.
\$49.38	\$53.84	\$51.16	\$53.58	\$52.26	\$59.19	See Web
Standard Formable Cable Assemblies						
PE-SR405FLJ Coax, 50 Ohm						
Part No.	PE3C4448	Cable Dia.	Attn. @ 1 GHz	Power @ 1 GHz		
1 piece price shown. See web or call for volume pricing.						
6"	12"	18"	24"	36"	48"	Custom Len.
\$58.69	\$68.71	\$66.23	\$69.99	\$77.51	\$85.03	See Web
Standard Flexible Cable Assemblies						
RG178B/U Coax, 50 Ohm						
Part No.	PE3C4395	Cable Dia.	Attn. @ 1 GHz	Power @ 1 GHz		
1 piece price shown. See web or call for volume pricing.						
6"	12"	18"	24"	36"	48"	Custom Len.
\$74.22	\$67.94	\$68.41	\$68.88	\$69.80	\$70.74	See Web
RG316/U Coax, 50 Ohm						
Part No.	PE3C4411	Cable Dia.	Attn. @ 1 GHz	Power @ 1 GHz		
1 piece price shown. See web or call for volume pricing.						
6"	12"	18"	24"	36"	48"	Custom Len.
\$61.00	\$62.41	\$63.82	\$65.20	\$72.41	\$75.71	See Web
SMA FEMALE BULKHEAD TO SSMC PLUG RIGHT ANGLE						
SEE MOUNTING HOLE SECTION ON PAGE 369						
Low Loss Flexible Cable Assemblies						
LMR-100A-PVC Coax, 50 Ohm						
Part No.	PE3C4429	Cable Dia.	Attn. @ 1 GHz	Power @ 1 GHz		
1 piece price shown. See web or call for volume pricing.						
6"	12"	18"	24"	36"	48"	Custom Len.
\$45.95	\$47.36	\$47.73	\$50.15	\$48.83	\$55.76	See Web
Standard Formable Cable Assemblies						
PE-SR405FLJ Coax, 50 Ohm						
Part No.	PE3C4486	Cable Dia.	Attn. @ 1 GHz	Power @ 1 GHz		
1 piece price shown. See web or call for volume pricing.						
6"	12"	18"	24"	36"	48"	Custom Len.
\$55.60	\$59.37	\$63.13	\$73.84	\$74.41	\$81.94	See Web
Standard Flexible Cable Assemblies						
RG178B/U Coax, 50 Ohm						
Part No.	PE3C4465	Cable Dia.	Attn. @ 1 GHz	Power @ 1 GHz		
1 piece price shown. See web or call for volume pricing.						
6"	12"	18"	24"	36"	48"	Custom Len.
\$59.06	\$59.52	\$59.99	\$60.46	\$61.39	\$62.32	See Web
RG316/U Coax, 50 Ohm						
Part No.	PE3C4412	Cable Dia.	Attn. @ 1 GHz	Power @ 1 GHz		
1 piece price shown. See web or call for volume pricing.						
6"	12"	18"	24"	36"	48"	Custom Len.
\$57.57	\$58.97	\$64.08	\$61.77	\$64.58	\$67.38	See Web
RG316-DS Coax, 50 Ohm						

\*Coax Performance at 1 GHz Notes: Cable assembly max frequency may be lower than connector or coax max frequency

For our complete selection of cable assemblies, please visit our website

Part No. <a href="#">PE3C4474</a>				Cable Dia.	Attn. @ 1 GHz	Power @ 1 GHz	97
1 piece price shown. See web or call for volume pricing.				0.114" dia.	9 dB/100ft	85 W	
6"	12"	18"	24"	36"	48"	Custom Len.	
\$63.33	\$71.22	\$72.79	\$67.58	\$70.40	\$73.23	See Web	

**SMA FEMALE BULKHEAD TO TNC MALE**

SEE MOUNTING HOLE SECTION ON PAGE 369



**Low Loss Flexible Cable Assemblies**

PE-P142LL-27478 Coax, 50 Ohm

Part No. <a href="#">PE3M0146</a>				Cable Dia.	Attn. @ 1 GHz	Power @ 1 GHz	98
1 piece price shown. See web or call for volume pricing.				0.195" dia.	dB/100ft	W	
12"	18"	24"	36"	48"	60"	Custom Len.	
\$466.72	\$475.20	\$483.68	\$500.63	\$517.59	\$534.54	See Web	

PE-P160LL-27478 Coax, 50 Ohm

Part No. <a href="#">PE3M0191</a>				Cable Dia.	Attn. @ 1 GHz	Power @ 1 GHz	99
1 piece price shown. See web or call for volume pricing.				0.160" dia.	dB/100ft	W	
8"	12"	18"	24"	30"	36"	Custom Len.	
\$455.66	\$460.57	\$467.92	\$475.27	\$482.63	\$489.97	See Web	

PE-P160LL Coax, 50 Ohm

Part No. <a href="#">PE3C5264</a>				Cable Dia.	Attn. @ 1 GHz	Power @ 1 GHz	1
1 piece price shown. See web or call for volume pricing.				0.160" dia.	dB/100ft	W	
12"	24"	36"	48"	60"	50CM	Custom Len.	
\$222.45	\$243.17	\$263.87	\$284.59	\$305.30	\$235.72	See Web	

**SMA FEMALE BULKHEAD TO TNC MALE RIGHT ANGLE**

SEE MOUNTING HOLE SECTION ON PAGE 369



**Low Loss Flexible Cable Assemblies**

PE-P142LL-27478 Coax, 50 Ohm

Part No. <a href="#">PE3M0148</a>				Cable Dia.	Attn. @ 1 GHz	Power @ 1 GHz	2
1 piece price shown. See web or call for volume pricing.				0.195" dia.	dB/100ft	W	
12"	18"	24"	36"	48"	60"	Custom Len.	
\$573.40	\$581.88	\$590.36	\$607.32	\$624.27	\$641.23	See Web	

PE-P160LL-27478 Coax, 50 Ohm

Part No. <a href="#">PE3M0193</a>				Cable Dia.	Attn. @ 1 GHz	Power @ 1 GHz	3
1 piece price shown. See web or call for volume pricing.				0.160" dia.	dB/100ft	W	
8"	12"	18"	24"	30"	36"	Custom Len.	
\$540.67	\$545.58	\$552.92	\$560.28	\$567.63	\$574.98	See Web	

PE-P160LL Coax, 50 Ohm

Part No. <a href="#">PE3C5265</a>				Cable Dia.	Attn. @ 1 GHz	Power @ 1 GHz	4
1 piece price shown. See web or call for volume pricing.				0.160" dia.	dB/100ft	W	
12"	24"	36"	48"	60"	50CM	Custom Len.	
\$281.22	\$243.17	\$263.87	\$284.59	\$305.30	\$235.72	See Web	

**SMA FEMALE BULKHEAD TO TNC FEMALE BULKHEAD**

SEE MOUNTING HOLE SECTION ON PAGE 369



**Low Loss Flexible Cable Assemblies**

PE-P142LL-27478 Coax, 50 Ohm

Part No. <a href="#">PE3M0147</a>				Cable Dia.	Attn. @ 1 GHz	Power @ 1 GHz	5
1 piece price shown. See web or call for volume pricing.				0.195" dia.	dB/100ft	W	
12"	18"	24"	36"	48"	60"	Custom Len.	
\$545.81	\$554.05	\$562.52	\$579.48	\$596.44	\$613.39	See Web	

PE-P160LL-27478 Coax, 50 Ohm

Part No. <a href="#">PE3M0192</a>				Cable Dia.	Attn. @ 1 GHz	Power @ 1 GHz	6
1 piece price shown. See web or call for volume pricing.				0.160" dia.	dB/100ft	W	
8"	12"	18"	24"	30"	36"	Custom Len.	
\$536.74	\$541.64	\$549.00	\$556.34	\$563.70	\$571.04	See Web	

PE-P160LL Coax, 50 Ohm

Part No. <a href="#">PE3C5266</a>				Cable Dia.	Attn. @ 1 GHz	Power @ 1 GHz	7
1 piece price shown. See web or call for volume pricing.				0.160" dia.	dB/100ft	W	
12"	24"	36"	48"	60"	50CM	Custom Len.	
\$248.74	\$269.45	\$290.16	\$310.87	\$331.59	\$262.00	See Web	

**SMA FEMALE BULKHEAD TO HMCX32 1.2 PLUG**

SEE MOUNTING HOLE SECTION ON PAGE 369



**Standard Flexible Cable Assemblies**

PE-81mm Coax, 50 Ohm

Part No. <a href="#">PE3CA1007</a>				Cable Dia.	Attn. @ 1 GHz	Power @ 1 GHz	8
1 piece price shown. See web or call for volume pricing.				0.032" dia.	dB/100ft	W	
3"	6"	12"	-	-	-	Custom Len.	
\$13.92	\$12.93	\$12.93	-	-	-	See Web	

**SMA FEMALE BULKHEAD TO UMCX PLUG RIGHT ANGLE**

SEE MOUNTING HOLE SECTION ON PAGE 369



**Standard Flexible Cable Assemblies**

RG178B/U Coax, 50 Ohm

Part No. <a href="#">PE3E299</a>				Cable Dia.	Attn. @ 1 GHz	Power @ 1 GHz	9
1 piece price shown. See web or call for volume pricing.				0.072" dia.	44 dB/100ft	78 W	
3"	6"	9"	12"	18"	24"	Custom Len.	
\$66.75	\$68.46	\$70.17	\$71.89	\$75.42	\$76.48	See Web	

**SMA FEMALE BULKHEAD TO UMCX 2.1 PLUG**

SEE MOUNTING HOLE SECTION ON PAGE 369



**Standard Flexible Cable Assemblies**

PE-81mm Coax, 50 Ohm

Part No. <a href="#">PE3CA1005</a>				Cable Dia.	Attn. @ 1 GHz	Power @ 1 GHz	10
1 piece price shown. See web or call for volume pricing.				0.032" dia.	dB/100ft	W	
3"	6"	12"	-	-	-	Custom Len.	
\$11.21	\$12.93	\$12.33	-	-	-	See Web	

**SMA FEMALE BULKHEAD TO UMCX 2.5 PLUG**

SEE MOUNTING HOLE SECTION ON PAGE 369



**Standard Flexible Cable Assemblies**

RG178B/U Coax, 50 Ohm

Part No. <a href="#">PE3CA1003</a>				Cable Dia.	Attn. @ 1 GHz	Power @ 1 GHz	11
1 piece price shown. See web or call for volume pricing.				0.070" dia.	dB/100ft	W	
6"	9"	12"	-	-	-	Custom Len.	
\$12.93	\$12.93	\$11.88	-	-	-	See Web	

RG178-DS Coax, 50 Ohm

Part No. <a href="#">PE3CA1004</a>				Cable Dia.	Attn. @ 1 GHz	Power @ 1 GHz	12
1 piece price shown. See web or call for volume pricing.				0.086" dia.	dB/100ft	W	
6"	9"	12"	-	-	-	Custom Len.	
\$13.42	\$13.60	\$14.05	-	-	-	See Web	

PE-81mm Coax, 50 Ohm

Part No. <a href="#">PE3CA1000</a>				Cable Dia.	Attn. @ 1 GHz	Power @ 1 GHz	13
1 piece price shown. See web or call for volume pricing.				0.032" dia.	dB/100ft	W	
3"	6"	12"	-	-	-	Custom Len.	
\$12.93	\$11.44	\$12.93	-	-	-	See Web	

PE-113mm Coax, 50 Ohm

Part No. <a href="#">PE3CA1001</a>				Cable Dia.	Attn. @ 1 GHz	Power @ 1 GHz	14
1 piece price shown. See web or call for volume pricing.				0.044" dia.	dB/100ft	W	
3"	6"	9"	12"	-	-	Custom Len.	
\$14.28	\$12.38	\$12.56	\$12.38	-	-	See Web	

PE-137mm Coax, 50 Ohm

Part No. <a href="#">PE3CA1002</a>				Cable Dia.	Attn. @ 1 GHz	Power @ 1 GHz	15
1 piece price shown. See web or call for volume pricing.				0.053" dia.	dB/100ft	W	
3"	6"	12"	-	-	-	Custom Len.	
\$12.93	\$13.51	\$12.93	-	-	-	See Web	

**SMA FEMALE BULKHEAD TO WMCX 1.6 PLUG**

SEE MOUNTING HOLE SECTION ON PAGE 369



**Standard Flexible Cable Assemblies**

PE-81mm Coax, 50 Ohm

Part No. <a href="#">PE3CA1006</a>				Cable Dia.	Attn. @ 1 GHz	Power @ 1 GHz	16
1 piece price shown. See web or call for volume pricing.				0.032" dia.	dB/100ft	W	
3"	6"	12"	-	-	-	Custom Len.	
\$11.21	\$12.93	\$12.93	-	-	-	See Web	

**REVERSE POLARITY SMA FEMALE BULKHEAD TO SMA MALE**

SEE MOUNTING HOLE SECTION ON PAGE 369



**Standard Formable Cable Assemblies**

PE-SR405FLJ Coax, 50 Ohm

Part No. <a href="#">PE3W04623</a>				Cable Dia.	Attn. @ 1 GHz	Power @ 1 GHz	17
1 piece price shown. See web or call for volume pricing.				0.105" dia.	20 dB/100ft	122 W	
12"	24"	36"	48"	60"	50CM	Custom Len.	
\$68.32	\$77.27	\$86.23	\$95.18	\$104.14	\$74.06	See Web	

**REVERSE POLARITY SMA FEMALE BULKHEAD TO SMA MALE RIGHT ANGLE**

SEE MOUNTING HOLE SECTION ON PAGE 369



**Standard Formable Cable Assemblies**

PE-SR405FLJ Coax, 50 Ohm

Part No. <a href="#">PE3W04625</a>				Cable Dia.	Attn. @ 1 GHz	Power @ 1 GHz	18
1 piece price shown. See web or call for volume pricing.				0.105" dia.	20 dB/100ft	122 W	
12"	24"	36"	48"	60"	50CM	Custom Len.	
\$89.00	\$97.95	\$106.90	\$115.86	\$124.82	\$94.74	See Web	

**REVERSE POLARITY SMA FEMALE BULKHEAD TO HMCX32 1.2 PLUG**

SEE MOUNTING HOLE SECTION ON PAGE 369



**Standard Flexible Cable Assemblies**

Cable Assemblies

See Our Website For Current Pricing & Real-Time Stock Availability!

Continued on Next Page

For Custom Lengths, Metric Lengths or Special Configurations, Please call (949) 261-1920

Technical Support  
+1 (949) 261-1920

Same-Day Shipping,  
Even Custom Cable Assemblies

For our complete selection of cable assemblies, please visit our website

Cable Assemblies

See Our Website For Current Pricing & Real-Time Stock Availability!

PE-81mm Coax, 50 Ohm				
Part No. <a href="#">PE3CA1022</a>	Cable Dia.	Attn. @ 1 GHz	Power @ 1 GHz	
1 piece price shown. See web or call for volume pricing.				
3"	6"	12"	-	Custom Len.
\$12.93	\$12.93	\$12.38	-	See Web
<b>REVERSE POLARITY SMA FEMALE BULKHEAD TO UMCX PLUG</b> SEE MOUNTING HOLE SECTION ON PAGE 369				
Standard Flexible Cable Assemblies				
RG178B/U Coax, 50 Ohm				
Part No. <a href="#">PE38300</a>	Cable Dia.	Attn. @ 1 GHz	Power @ 1 GHz	
1 piece price shown. See web or call for volume pricing.				
3"	6"	9"	12"	18"
\$55.12	\$55.12	\$55.12	\$55.12	\$58.81
\$65.49	-	-	-	See Web
<b>REVERSE POLARITY SMA FEMALE BULKHEAD TO UMCX 2.1 PLUG</b> SEE MOUNTING HOLE SECTION ON PAGE 369				
Standard Flexible Cable Assemblies				
PE-81mm Coax, 50 Ohm				
Part No. <a href="#">PE3CA1033</a>	Cable Dia.	Attn. @ 1 GHz	Power @ 1 GHz	
1 piece price shown. See web or call for volume pricing.				
3"	6"	12"	-	Custom Len.
\$12.93	\$14.28	\$12.93	-	See Web
<b>REVERSE POLARITY SMA FEMALE BULKHEAD TO UMCX 2.5 PLUG</b> SEE MOUNTING HOLE SECTION ON PAGE 369				
Standard Flexible Cable Assemblies				
RG178B/U Coax, 50 Ohm				
Part No. <a href="#">PE3CA1019</a>	Cable Dia.	Attn. @ 1 GHz	Power @ 1 GHz	
1 piece price shown. See web or call for volume pricing.				
6"	9"	12"	-	Custom Len.
\$11.21	\$12.33	\$12.93	-	See Web
<b>REVERSE POLARITY SMA FEMALE BULKHEAD TO WMCX 1.6 PLUG</b> SEE MOUNTING HOLE SECTION ON PAGE 369				
Standard Flexible Cable Assemblies				
PE-81mm Coax, 50 Ohm				
Part No. <a href="#">PE3CA1016</a>	Cable Dia.	Attn. @ 1 GHz	Power @ 1 GHz	
1 piece price shown. See web or call for volume pricing.				
3"	6"	12"	-	Custom Len.
\$11.21	\$12.93	\$11.21	-	See Web
<b>REVERSE POLARITY SMA FEMALE BULKHEAD TO SMA FEMALE 2 HOLE FLANGE</b> SEE MOUNTING HOLE SECTION ON PAGE 369				
Standard Formable Cable Assemblies				
PE-SR407FL Coax, 50 Ohm				
Part No. <a href="#">PE35154</a>	Cable Dia.	Attn. @ 1 GHz	Power @ 1 GHz	
1 piece price shown. See web or call for volume pricing.				
6"	12"	18"	24"	36"
\$87.11	\$95.82	\$90.80	\$94.49	\$101.86
\$109.22	-	-	-	See Web
<b>SMA FEMALE 2 HOLE FLANGE TO SMA FEMALE 2 HOLE FLANGE</b> SEE MOUNTING HOLE SECTION ON PAGE 369				
Standard Formable Cable Assemblies				
PE-SR402FL Coax, 50 Ohm				
Part No. <a href="#">PE35108</a>	Cable Dia.	Attn. @ 1 GHz	Power @ 1 GHz	
1 piece price shown. See web or call for volume pricing.				
6"	12"	18"	24"	36"
\$76.84	\$80.44	\$84.11	\$87.76	\$95.09
\$102.35	-	-	-	See Web
<b>SMA FEMALE 4 HOLE FLANGE TO SMA FEMALE 4 HOLE FLANGE</b> SEE MOUNTING HOLE SECTION ON PAGE 369				
Standard Formable Cable Assemblies				
PE-SR405FL Coax, 50 Ohm				
Part No. <a href="#">PE35102</a>	Cable Dia.	Attn. @ 1 GHz	Power @ 1 GHz	
1 piece price shown. See web or call for volume pricing.				
6"	12"	18"	24"	36"
\$101.04	\$101.04	\$104.70	\$114.92	\$122.75
\$131.03	-	-	-	See Web

PE-047SR Coax, 50 Ohm				
Part No. <a href="#">PE35114</a>	Cable Dia.	Attn. @ 1 GHz	Power @ 1 GHz	
1 piece price shown. See web or call for volume pricing.				
6"	12"	18"	24"	36"
\$68.08	\$73.24	\$78.40	\$83.62	\$100.33
\$104.33	-	-	-	See Web
Standard Semi-Rigid Cable Assemblies				
PE-047SR Coax, 50 Ohm				
Part No. <a href="#">PE35064</a>	Cable Dia.	Attn. @ 1 GHz	Power @ 1 GHz	
1 piece price shown. See web or call for volume pricing.				
6"	12"	18"	24"	36"
\$90.08	\$95.45	\$95.17	\$106.52	\$110.52
\$120.76	-	-	-	See Web
Standard Semi-Rigid Cable Assemblies				
RG402/U Coax, 50 Ohm				
Part No. <a href="#">PE3525</a>	Cable Dia.	Attn. @ 1 GHz	Power @ 1 GHz	
1 piece price shown. See web or call for volume pricing.				
6"	12"	18"	24"	36"
\$76.72	\$80.26	\$83.81	\$96.11	\$94.43
\$101.50	-	-	-	See Web
Standard Semi-Rigid Cable Assemblies				
RG405/U Coax, 50 Ohm				
Part No. <a href="#">PE33191</a>	Cable Dia.	Attn. @ 1 GHz	Power @ 1 GHz	
1 piece price shown. See web or call for volume pricing.				
6"	12"	18"	24"	36"
\$77.45	\$81.05	\$77.12	\$80.55	\$87.43
\$94.29	-	-	-	See Web
<b>SMA FEMALE 2 HOLE FLANGE TO SMP FEMALE</b> SEE MOUNTING HOLE SECTION ON PAGE 369				
Standard Semi-Rigid Cable Assemblies				
PE-047SR Coax, 50 Ohm				
Part No. <a href="#">PE3W05930</a>	Cable Dia.	Attn. @ 1 GHz	Power @ 1 GHz	
1 piece price shown. See web or call for volume pricing.				
12"	24"	36"	48"	60"
\$79.53	\$101.09	\$111.84	\$122.58	\$133.32
\$97.23	-	-	-	See Web
<b>SMA FEMALE 2 HOLE FLANGE TO SMP FEMALE RIGHT ANGLE</b> SEE MOUNTING HOLE SECTION ON PAGE 369				
Standard Formable Cable Assemblies				
PE-SR405FLJ Coax, 50 Ohm				
Part No. <a href="#">PE3W05557</a>	Cable Dia.	Attn. @ 1 GHz	Power @ 1 GHz	
1 piece price shown. See web or call for volume pricing.				
12"	24"	36"	48"	60"
\$107.85	\$116.83	\$125.80	\$134.78	\$143.76
\$113.63	-	-	-	See Web
<b>SMA FEMALE 4 HOLE FLANGE TO MMCX PLUG RIGHT ANGLE</b> SEE MOUNTING HOLE SECTION ON PAGE 369				
Low Loss Flexible Cable Assemblies				
LMR-100A-PVC Coax, 50 Ohm				
Part No. <a href="#">PE3C0064</a>	Cable Dia.	Attn. @ 1 GHz	Power @ 1 GHz	
1 piece price shown. See web or call for volume pricing.				
12"	24"	36"	48"	60"
\$92.30	\$93.05	\$93.81	\$94.57	\$95.33
-	-	-	-	See Web
<b>SMA FEMALE 4 HOLE FLANGE TO SMA FEMALE 4 HOLE FLANGE</b> SEE MOUNTING HOLE SECTION ON PAGE 369				
Standard Formable Cable Assemblies				
PE-SR047FL Coax, 50 Ohm				
Part No. <a href="#">PE35112</a>	Cable Dia.	Attn. @ 1 GHz	Power @ 1 GHz	
1 piece price shown. See web or call for volume pricing.				
6"	12"	18"	24"	36"
\$104.08	\$103.54	\$107.10	\$110.68	\$117.83
\$124.98	-	-	-	See Web
Standard Formable Cable Assemblies				
PE-SR402FL Coax, 50 Ohm				
Part No. <a href="#">PE35110</a>	Cable Dia.	Attn. @ 1 GHz	Power @ 1 GHz	
1 piece price shown. See web or call for volume pricing.				
6"	12"	18"	24"	36"
\$91.85	\$95.52	\$99.17	\$102.82	\$110.09
\$117.42	-	-	-	See Web
Standard Formable Cable Assemblies				
PE-SR405FL Coax, 50 Ohm				
Part No. <a href="#">PE35116</a>	Cable Dia.	Attn. @ 1 GHz	Power @ 1 GHz	
1 piece price shown. See web or call for volume pricing.				
6"	12"	18"	24"	36"
\$96.43	\$102.22	\$101.76	\$107.11	\$117.81
\$128.50	-	-	-	See Web
Standard Semi-Rigid Cable Assemblies				
PE-047SR Coax, 50 Ohm				
Part No. <a href="#">PE35118</a>	Cable Dia.	Attn. @ 1 GHz	Power @ 1 GHz	
1 piece price shown. See web or call for volume pricing.				
6"	12"	18"	24"	36"
\$112.70	\$119.46	\$124.99	\$122.92	\$133.17
\$143.40	-	-	-	See Web
Standard Semi-Rigid Cable Assemblies				
RG402/U Coax, 50 Ohm				
Part No. <a href="#">PE33502</a>	Cable Dia.	Attn. @ 1 GHz	Power @ 1 GHz	
1 piece price shown. See web or call for volume pricing.				
6"	12"	18"	24"	36"
\$101.04	\$101.04	\$104.70	\$114.92	\$122.75
\$131.03	-	-	-	See Web

\*Coax Performance at 1 GHz Notes: Cable assembly max frequency may be lower than connector or coax max frequency



For our complete selection of cable assemblies, please visit our website

RG405/U Coax, 50 Ohm						
Part No. <b>PE3223</b>	Cable Dia.			Attn. @ 1 GHz	Power @ 1 GHz	
1 piece price shown. See web or call for volume pricing.						
6"	12"	18"	24"	36"	48"	Custom Len.
\$100.48	\$100.48	\$110.23	\$113.94	\$114.23	\$121.09	See Web

**SMB PLUG TO BNC MALE**



**Standard Flexible Cable Assemblies**

RG58C/U Coax, 50 Ohm						
Part No. <b>PE3242</b>	Cable Dia.			Attn. @ 1 GHz	Power @ 1 GHz	
1 piece price shown. See web or call for volume pricing.						
12"	24"	36"	48"	60"	72"	Custom Len.
\$48.53	\$49.35	\$50.16	\$51.03	\$51.86	\$52.68	See Web

RG142B/U Coax, 50 Ohm						
Part No. <b>PE3349</b>	Cable Dia.			Attn. @ 1 GHz	Power @ 1 GHz	
1 piece price shown. See web or call for volume pricing.						
12"	24"	36"	48"	60"	72"	Custom Len.
\$47.62	\$53.70	\$59.78	\$66.22	\$67.85	\$78.60	See Web

RG174A/U Coax, 50 Ohm						
Part No. <b>PE3C3318</b>	Cable Dia.			Attn. @ 1 GHz	Power @ 1 GHz	
1 piece price shown. See web or call for volume pricing.						
12"	24"	36"	48"	60"	72"	Custom Len.
\$37.91	\$38.49	\$39.08	\$39.68	\$40.27	\$40.86	See Web

RG178B/U Coax, 50 Ohm						
Part No. <b>PE33825</b>	Cable Dia.			Attn. @ 1 GHz	Power @ 1 GHz	
1 piece price shown. See web or call for volume pricing.						
12"	24"	36"	48"	60"	-	Custom Len.
\$59.06	\$60.12	\$61.18	\$62.30	\$63.38	-	See Web

RG188A/U Coax, 50 Ohm						
Part No. <b>PE3C3428</b>	Cable Dia.			Attn. @ 1 GHz	Power @ 1 GHz	
1 piece price shown. See web or call for volume pricing.						
12"	24"	36"	48"	60"	72"	Custom Len.
\$42.78	\$49.55	\$47.22	\$54.68	\$57.22	\$59.76	See Web

RG223/U Coax, 50 Ohm						
Part No. <b>PE3236</b>	Cable Dia.			Attn. @ 1 GHz	Power @ 1 GHz	
1 piece price shown. See web or call for volume pricing.						
12"	24"	36"	48"	60"	72"	Custom Len.
\$44.57	\$47.68	\$50.80	\$54.09	\$57.27	\$60.45	See Web

PE-P195 Coax, 50 Ohm						
Part No. <b>PE37250</b>	Cable Dia.			Attn. @ 1 GHz	Power @ 1 GHz	
1 piece price shown. See web or call for volume pricing.						
12"	24"	36"	48"	60"	-	Custom Len.
\$53.07	\$62.65	\$67.77	\$76.63	\$85.48	-	See Web

**SMB PLUG TO N FEMALE**



**Standard Flexible Cable Assemblies**

RG141A/U Coax, 50 Ohm						
Part No. <b>PE3W04161</b>	Cable Dia.			Attn. @ 1 GHz	Power @ 1 GHz	
1 piece price shown. See web or call for volume pricing.						
12"	24"	36"	48"	60"	50CM	Custom Len.
\$57.50	\$64.88	\$72.25	\$79.63	\$87.01	\$62.23	See Web

**SMB PLUG TO SMB PLUG**



**Standard Flexible Cable Assemblies**

PE-B100 Coax, 50 Ohm						
Part No. <b>PE34488</b>	Cable Dia.			Attn. @ 1 GHz	Power @ 1 GHz	
1 piece price shown. See web or call for volume pricing.						
12"	24"	36"	48"	60"	72"	Custom Len.
\$48.33	\$60.26	\$67.36	\$68.92	\$75.75	\$82.65	See Web

RG58C/U Coax, 50 Ohm						
Part No. <b>PE33650</b>	Cable Dia.			Attn. @ 1 GHz	Power @ 1 GHz	
1 piece price shown. See web or call for volume pricing.						
12"	24"	36"	48"	60"	72"	Custom Len.
\$58.27	\$63.74	\$64.55	\$60.47	\$61.21	\$61.93	See Web

RG142B/U Coax, 50 Ohm						
Part No. <b>PE33652</b>	Cable Dia.			Attn. @ 1 GHz	Power @ 1 GHz	
1 piece price shown. See web or call for volume pricing.						
12"	24"	36"	48"	60"	72"	Custom Len.
\$50.67	\$61.82	\$67.90	\$67.31	\$72.88	\$86.73	See Web

RG174A/U Coax, 50 Ohm						
Part No. <b>PE3853</b>	Cable Dia.			Attn. @ 1 GHz	Power @ 1 GHz	
1 piece price shown. See web or call for volume pricing.						
12"	24"	36"	48"	60"	72"	Custom Len.
\$44.45	\$44.88	\$45.31	\$45.75	\$46.18	\$46.62	See Web

RG178B/U Coax, 50 Ohm						
Part No. <b>PE33672</b>	Cable Dia.			Attn. @ 1 GHz	Power @ 1 GHz	
1 piece price shown. See web or call for volume pricing.						
12"	24"	36"	48"	60"	72"	Custom Len.
\$53.74	\$56.74	\$59.74	\$62.73	\$65.73	\$68.74	See Web

RG188A/U Coax, 50 Ohm						
Part No. <b>PE33165</b>	Cable Dia.			Attn. @ 1 GHz	Power @ 1 GHz	
1 piece price shown. See web or call for volume pricing.						
12"	24"	36"	48"	60"	72"	Custom Len.
\$56.94	\$58.00	\$59.06	\$56.59	\$61.26	\$62.34	See Web

RG188-DS Coax, 50 Ohm						
Part No. <b>PE3587</b>	Cable Dia.			Attn. @ 1 GHz	Power @ 1 GHz	
1 piece price shown. See web or call for volume pricing.						
12"	24"	36"	48"	60"	72"	Custom Len.
\$50.87	\$53.36	\$51.53	\$53.76	\$55.98	\$63.58	See Web

RG196A/U Coax, 50 Ohm						
Part No. <b>PE3721</b>	Cable Dia.			Attn. @ 1 GHz	Power @ 1 GHz	
1 piece price shown. See web or call for volume pricing.						
12"	24"	36"	48"	60"	72"	Custom Len.
\$48.32	\$51.72	\$55.12	\$58.54	\$61.93	\$65.33	See Web

RG223/U Coax, 50 Ohm						
Part No. <b>PE3166</b>	Cable Dia.			Attn. @ 1 GHz	Power @ 1 GHz	
1 piece price shown. See web or call for volume pricing.						
12"	24"	36"	48"	60"	72"	Custom Len.
\$56.00	\$59.12	\$62.24	\$61.54	\$64.43	\$67.34	See Web

RG316/U Coax, 50 Ohm						
Part No. <b>PE3915</b>	Cable Dia.			Attn. @ 1 GHz	Power @ 1 GHz	
1 piece price shown. See web or call for volume pricing.						
12"	24"	36"	48"	60"	72"	Custom Len.
\$50.88	\$54.00	\$57.12	\$60.44	\$63.62	\$66.81	See Web

RG316-DS Coax, 50 Ohm						
Part No. <b>PE33704</b>	Cable Dia.			Attn. @ 1 GHz	Power @ 1 GHz	
1 piece price shown. See web or call for volume pricing.						
12"	24"	36"	48"	60"	72"	Custom Len.
\$49.83	\$52.96	\$56.09	\$56.66	\$59.58	\$65.77	See Web

RG400/U Coax, 50 Ohm						
Part No. <b>PE34269</b>	Cable Dia.			Attn. @ 1 GHz	Power @ 1 GHz	
1 piece price shown. See web or call for volume pricing.						
12"	24"	36"	48"	60"	72"	Custom Len.
\$63.99	\$71.39	\$72.23	\$79.23	\$94.14	\$93.28	See Web

**SMB PLUG TO SMB PLUG RIGHT ANGLE**



**Standard Flexible Cable Assemblies**

PE-B100 Coax, 50 Ohm						
Part No. <b>PE34490</b>	Cable Dia.			Attn. @ 1 GHz	Power @ 1 GHz	
1 piece price shown. See web or call for volume pricing.						
12"	24"	36"	48"	60"	72"	Custom Len.
\$51.63	\$58.47	\$65.32	\$72.23	\$79.07	\$85.96	See Web

RG58C/U Coax, 50 Ohm						
Part No. <b>PE33666</b>	Cable Dia.			Attn. @ 1 GHz	Power @ 1 GHz	
1 piece price shown. See web or call for volume pricing.						
12"	24"	36"	48"	60"	72"	Custom Len.
\$60.44	\$61.18	\$61.91	\$62.65	\$63.38	\$64.12	See Web

RG174A/U Coax, 50 Ohm						
Part No. <b>PE33175</b>	Cable Dia.			Attn. @ 1 GHz	Power @ 1 GHz	
1 piece price shown. See web or call for volume pricing.						
12"	24"	36"	48"	60"	72"	Custom Len.
\$55.32	\$55.75	\$56.18	\$62.62	\$63.20	\$63.79	See Web

RG178B/U Coax, 50 Ohm						
Part No. <b>PE33356</b>	Cable Dia.			Attn. @ 1 GHz	Power @ 1 GHz	
1 piece price shown. See web or call for volume pricing.						
12"	24"	36"	48"	60"	72"	Custom Len.
\$63.49	\$64.44	\$65.41	\$66.37	\$67.33	\$68.28	See Web

RG188A/U Coax, 50 Ohm						
Part No. <b>PE3592</b>	Cable Dia.			Attn. @ 1 GHz	Power @ 1 GHz	
1 piece price shown. See web or call for volume pricing.						
12"	24"	36"	48"	60"	72"	Custom Len.
\$52.91	\$54.99	\$57.16	\$59.32	\$61.43	\$63.58	See Web

RG188-DS Coax, 50 Ohm						
Part No. <b>PE33143</b>	Cable Dia.			Attn. @ 1 GHz	Power @ 1 GHz	
1 piece price shown. See web or call for volume pricing.						
12"	24"	36"	48"	60"	72"	Custom Len.
\$58.37	\$61.77	\$65.17	\$68.56	\$71.97	\$75.38	See Web

RG223/U Coax, 50 Ohm						
Part No. <b>PE33670</b>	Cable Dia.			Attn. @ 1 GHz	Power @ 1 GHz	
1 piece price shown. See web or call for volume pricing.						
12"	24"	36"	48"	60"	72"	Custom Len.
\$51.16	\$54.04	\$61.48	\$59.86	\$62.80	\$65.73	See Web

RG316/U Coax, 50 Ohm						
Part No. <b>PE33672</b>	Cable Dia.			Attn. @ 1 GHz	Power @ 1 GHz	
1 piece price shown. See web or call for volume pricing.						
12"	24"	36"	48"	60"	72"	Custom Len.
\$53.74	\$56.74	\$59.74	\$62.73	\$65.73	\$68.74	See Web

Cable Assemblies

See Our Website For Current Pricing & Real-Time Stock Availability!

For Custom Lengths, Metric Lengths or Special Configurations, Please call (949) 261-1920



Technical Support  
+1 (949) 261-1920



Same-Day Shipping,  
Even Custom Cable Assemblies

For our complete selection of cable assemblies, please visit our website

Cable Assemblies

See Our Website For Current Pricing & Real-Time Stock Availability!

RG316-DS Coax, 50 Ohm							
Part No.	PE34485				Cable Dia.	Attn. @ 1 GHz	Power @ 1 GHz
1 piece price shown. See web or call for volume pricing.							
12"	24"	36"	48"	60"	72"	Custom Len.	160 W
\$57.98	\$60.90	\$63.80	\$72.17	\$69.62	\$72.53	See Web	

RG400/U Coax, 50 Ohm							
Part No.	PE34481				Cable Dia.	Attn. @ 1 GHz	Power @ 1 GHz
1 piece price shown. See web or call for volume pricing.							
12"	24"	36"	48"	60"	72"	Custom Len.	650 W
\$67.23	\$74.27	\$81.28	\$88.32	\$95.32	\$102.35	See Web	

**SMB PLUG TO SMB JACK BULKHEAD**

SEE MOUNTING HOLE SECTION ON PAGE 369



**Standard Flexible Cable Assemblies**

PE-B100 Coax, 50 Ohm							
Part No.	PE34491				Cable Dia.	Attn. @ 1 GHz	Power @ 1 GHz
1 piece price shown. See web or call for volume pricing.							
12"	24"	36"	48"	60"	72"	Custom Len.	W
\$51.34	\$58.23	\$65.07	\$71.93	\$78.82	\$85.66	See Web	

RG142B/U Coax, 50 Ohm							
Part No.	PE34495				Cable Dia.	Attn. @ 1 GHz	Power @ 1 GHz
1 piece price shown. See web or call for volume pricing.							
12"	24"	36"	48"	60"	72"	Custom Len.	650 W
\$63.76	\$76.22	\$74.81	\$80.38	\$85.90	\$91.48	See Web	

RG174A/U Coax, 50 Ohm							
Part No.	PE33674				Cable Dia.	Attn. @ 1 GHz	Power @ 1 GHz
1 piece price shown. See web or call for volume pricing.							
12"	24"	36"	48"	60"	72"	Custom Len.	16 W
\$51.42	\$52.00	\$49.38	\$53.19	\$53.78	\$50.68	See Web	

RG178B/U Coax, 50 Ohm							
Part No.	PE33676				Cable Dia.	Attn. @ 1 GHz	Power @ 1 GHz
1 piece price shown. See web or call for volume pricing.							
12"	24"	36"	48"	60"	72"	Custom Len.	78 W
\$57.23	\$53.96	\$54.90	\$55.87	\$56.82	\$62.63	See Web	

RG188A/U Coax, 50 Ohm							
Part No.	PE3591				Cable Dia.	Attn. @ 1 GHz	Power @ 1 GHz
1 piece price shown. See web or call for volume pricing.							
12"	24"	36"	48"	60"	72"	Custom Len.	160 W
\$46.59	\$53.74	\$50.92	\$53.01	\$55.18	\$57.28	See Web	

RG188-DS Coax, 50 Ohm							
Part No.	PE34489				Cable Dia.	Attn. @ 1 GHz	Power @ 1 GHz
1 piece price shown. See web or call for volume pricing.							
12"	24"	36"	48"	60"	72"	Custom Len.	160 W
\$55.76	\$59.27	\$58.42	\$61.82	\$65.23	\$68.63	See Web	

RG196A/U Coax, 50 Ohm							
Part No.	PE3130				Cable Dia.	Attn. @ 1 GHz	Power @ 1 GHz
1 piece price shown. See web or call for volume pricing.							
12"	24"	36"	48"	60"	72"	Custom Len.	78 W
\$53.39	\$58.01	\$56.13	\$57.51	\$58.87	\$60.24	See Web	

RG223/U Coax, 50 Ohm							
Part No.	PE34497				Cable Dia.	Attn. @ 1 GHz	Power @ 1 GHz
1 piece price shown. See web or call for volume pricing.							
12"	24"	36"	48"	60"	72"	Custom Len.	53 W
\$61.12	\$64.00	\$66.94	\$69.88	\$72.77	\$75.70	See Web	

RG316/U Coax, 50 Ohm							
Part No.	PE33680				Cable Dia.	Attn. @ 1 GHz	Power @ 1 GHz
1 piece price shown. See web or call for volume pricing.							
12"	24"	36"	48"	60"	72"	Custom Len.	160 W
\$57.47	\$60.59	\$63.71	\$60.91	\$63.79	\$66.68	See Web	

RG316-DS Coax, 50 Ohm							
Part No.	PE34487				Cable Dia.	Attn. @ 1 GHz	Power @ 1 GHz
1 piece price shown. See web or call for volume pricing.							
12"	24"	36"	48"	60"	72"	Custom Len.	160 W
\$57.40	\$55.09	\$58.00	\$60.92	\$63.83	\$66.73	See Web	

RG400/U Coax, 50 Ohm							
Part No.	PE34483				Cable Dia.	Attn. @ 1 GHz	Power @ 1 GHz
1 piece price shown. See web or call for volume pricing.							
12"	24"	36"	48"	60"	72"	Custom Len.	650 W
\$71.20	\$78.24	\$85.24	\$92.25	\$99.30	\$106.31	See Web	

**SMB PLUG RIGHT ANGLE TO BNC MALE**



**Standard Flexible Cable Assemblies**

RG223/U Coax, 50 Ohm							
Part No.	PE3W06905				Cable Dia.	Attn. @ 1 GHz	Power @ 1 GHz
1 piece price shown. See web or call for volume pricing.							
12"	24"	36"	48"	60"	50CM	Custom Len.	50 W
\$43.59	\$46.83	\$50.07	\$53.31	\$56.55	\$45.65	See Web	

**SMB PLUG RIGHT ANGLE TO SMB PLUG RIGHT ANGLE**



**Low Loss Flexible Cable Assemblies**

PE-C195 Coax, 50 Ohm							
Part No.	PE39120				Cable Dia.	Attn. @ 1 GHz	Power @ 1 GHz
1 piece price shown. See web or call for volume pricing.							
12"	24"	36"	48"	60"	-	Custom Len.	150 W
\$53.56	\$54.34	\$50.92	\$51.58	\$52.24	-	See Web	

**Standard Flexible Cable Assemblies**

PE-B100 Coax, 50 Ohm							
Part No.	PE34465				Cable Dia.	Attn. @ 1 GHz	Power @ 1 GHz
1 piece price shown. See web or call for volume pricing.							
12"	24"	36"	48"	60"	72"	Custom Len.	W
\$60.37	\$67.45	\$74.55	\$81.64	\$88.74	\$95.83	See Web	

RG58C/U Coax, 50 Ohm							
Part No.	PE33654				Cable Dia.	Attn. @ 1 GHz	Power @ 1 GHz
1 piece price shown. See web or call for volume pricing.							
12"	24"	36"	48"	60"	72"	Custom Len.	44 W
\$68.77	\$64.41	\$65.15	\$65.88	\$66.62	\$72.92	See Web	

RG142B/U Coax, 50 Ohm							
Part No.	PE33656				Cable Dia.	Attn. @ 1 GHz	Power @ 1 GHz
1 piece price shown. See web or call for volume pricing.							
12"	24"	36"	48"	60"	72"	Custom Len.	650 W
\$67.89	\$73.61	\$84.12	\$85.08	\$90.82	\$102.94	See Web	

RG174A/U Coax, 50 Ohm							
Part No.	PE3916				Cable Dia.	Attn. @ 1 GHz	Power @ 1 GHz
1 piece price shown. See web or call for volume pricing.							
12"	24"	36"	48"	60"	72"	Custom Len.	16 W
\$63.52	\$64.11	\$59.68	\$60.12	\$60.54	\$60.99	See Web	

RG178B/U Coax, 50 Ohm							
Part No.	PE33350				Cable Dia.	Attn. @ 1 GHz	Power @ 1 GHz
1 piece price shown. See web or call for volume pricing.							
12"	24"	36"	48"	60"	72"	Custom Len.	78 W
\$65.69	\$66.64	\$67.61	\$68.56	\$69.52	\$70.49	See Web	

RG188A/U Coax, 50 Ohm							
Part No.	PE3589				Cable Dia.	Attn. @ 1 GHz	Power @ 1 GHz
1 piece price shown. See web or call for volume pricing.							
12"	24"	36"	48"	60"	72"	Custom Len.	160 W
\$60.70	\$69.26	\$65.13	\$67.36	\$69.57	\$71.79	See Web	

RG196A/U Coax, 50 Ohm							
Part No.	PE3590				Cable Dia.	Attn. @ 1 GHz	Power @ 1 GHz
1 piece price shown. See web or call for volume pricing.							
12"	24"	36"	48"	60"	72"	Custom Len.	78 W
\$61.19	\$62.51	\$63.83	\$65.13	\$66.45	\$67.77	See Web	

RG223/U Coax, 50 Ohm							
Part No.	PE33121				Cable Dia.	Attn. @ 1 GHz	Power @ 1 GHz
1 piece price shown. See web or call for volume pricing.							
12"	24"	36"	48"	60"	72"	Custom Len.	50 W
\$65.03	\$67.93	\$70.83	\$73.74	\$76.64	\$79.53	See Web	

RG316/U Coax, 50 Ohm							
Part No.	PE3917				Cable Dia.	Attn. @ 1 GHz	Power @ 1 GHz
1 piece price shown. See web or call for volume pricing.							
12"	24"	36"	48"	60"	72"	Custom Len.	160 W
\$62.75	\$70.89	\$68.52	\$77.32	\$74.30	\$83.69	See Web	

RG316-DS Coax, 50 Ohm							
Part No.	PE33476				Cable Dia.	Attn. @ 1 GHz	Power @ 1 GHz
1 piece price shown. See web or call for volume pricing.							
12"	24"	36"	48"	60"	72"	Custom Len.	160 W
\$66.48	\$69.60	\$67.37	\$70.28	\$73.19	\$76.11	See Web	

RG400/U Coax, 50 Ohm							
Part No.	PE34461				Cable Dia.	Attn. @ 1 GHz	Power @ 1 GHz
1 piece price shown. See web or call for volume pricing.							
12"	24"	36"	48"	60"	72"	Custom Len.	650 W
\$74.51	\$77.32	\$84.35	\$91.37	\$98.38	\$105.41	See Web	

**SMB PLUG RIGHT ANGLE TO SMB JACK BULKHEAD**

SEE MOUNTING HOLE SECTION ON PAGE 369



**Standard Flexible Cable Assemblies**

PE-B100 Coax, 50 Ohm							
Part No.	PE34479				Cable Dia.	Attn. @ 1 GHz	Power @ 1 GHz
1 piece price shown. See web or call for volume pricing.							
12"	24"	36"	48"	60"	72"	Custom Len.	W
\$54.64	\$61.49	\$68.39	\$75.22	\$82.12	\$88.97	See Web	

RG174A/U Coax, 50 Ohm							
Part No.	PE33261				Cable Dia.	Attn. @ 1 GHz	Power @ 1 GHz
1 piece price shown. See web or call for volume pricing.							
12"	24"	36"	48"	60"	72"	Custom Len.	16 W
\$59.64	\$60.07	\$60.51	\$60.95	\$61.38	\$61.81	See Web	

RG178B/U Coax, 50 Ohm							
Part No.	PE34467				Cable Dia.	Attn. @ 1 GHz	Power @ 1 GHz
1 piece price shown. See web or call for volume pricing.							
12"	24"	36"	48"	60"	72"	Custom Len.	78 W
\$62.87	\$58.12	\$59.08	\$60.03	\$60.99	\$61.96	See Web	

RG188A/U Coax, 50 Ohm						
-----------------------	--	--	--	--	--	--

\*Coax Performance at 1 GHz Notes: Cable assembly max frequency may be lower than connector or coax max frequency

For our complete selection of cable assemblies, please visit our website

Part No. <a href="#">PE3594</a>	Cable Dia.	Attn. @ 1 GHz	Power @ 1 GHz
1 piece price shown. See web or call for volume pricing.	0.110" dia.	26 dB/100ft	160 W
12" 24" 36" 48"	60"	72"	Custom Len.
\$60.37 \$62.58 \$64.80 \$67.02	\$69.24	\$71.46	See Web

**RG188-DS Coax, 50 Ohm**

Part No. <a href="#">PE33477</a>	Cable Dia.	Attn. @ 1 GHz	Power @ 1 GHz
1 piece price shown. See web or call for volume pricing.	0.122" dia.	30 dB/100ft	160 W
12" 24" 36" 48"	60"	72"	Custom Len.
\$62.75 \$60.35 \$63.64 \$66.94	\$70.24	\$73.49	See Web

**RG196A/U Coax, 50 Ohm**

Part No. <a href="#">PE33682</a>	Cable Dia.	Attn. @ 1 GHz	Power @ 1 GHz
1 piece price shown. See web or call for volume pricing.	0.080" dia.	49 dB/100ft	78 W
12" 24" 36" 48"	60"	72"	Custom Len.
\$57.52 \$58.84 \$60.16 \$61.49	\$62.80	\$64.12	See Web

**RG316/U Coax, 50 Ohm**

Part No. <a href="#">PE33675</a>	Cable Dia.	Attn. @ 1 GHz	Power @ 1 GHz
1 piece price shown. See web or call for volume pricing.	0.098" dia.	38 dB/100ft	160 W
12" 24" 36" 48"	60"	72"	Custom Len.
\$56.79 \$59.79 \$62.80 \$65.80	\$68.79	\$78.40	See Web

**RG316-DS Coax, 50 Ohm**

Part No. <a href="#">PE33349</a>	Cable Dia.	Attn. @ 1 GHz	Power @ 1 GHz
1 piece price shown. See web or call for volume pricing.	0.114" dia.	26 dB/100ft	160 W
12" 24" 36" 48"	60"	72"	Custom Len.
\$56.68 \$65.47 \$62.56 \$65.51	\$68.44	\$71.32	See Web

**SMB PLUG RIGHT ANGLE TO SSMB PLUG**



**Standard Flexible Cable Assemblies**

**RG174A/U Coax, 50 Ohm**

Part No. <a href="#">PE3W04513</a>	Cable Dia.	Attn. @ 1 GHz	Power @ 1 GHz
1 piece price shown. See web or call for volume pricing.	0.110" dia.	32 dB/100ft	17 W
12" 24" 36" 48"	60"	50CM	Custom Len.
\$56.70 \$57.26 \$57.82 \$58.38	\$58.94	\$56.49	See Web

**SMB PLUG TO 10-32 MALE RIGHT ANGLE**



**Standard Flexible Cable Assemblies**

**RG196A/U Coax, 50 Ohm**

Part No. <a href="#">PE3W00597</a>	Cable Dia.	Attn. @ 1 GHz	Power @ 1 GHz
1 piece price shown. See web or call for volume pricing.	0.080" dia.	dB/100ft	78 W
12" 24" 36" 48"	60"	50CM	Custom Len.
\$71.85 \$73.22 \$74.58 \$75.94	\$77.30	\$72.73	See Web

**SMB PLUG TO BNC MALE**



**Standard Flexible Cable Assemblies**

**RG58C/U Coax, 50 Ohm**

Part No. <a href="#">PE3244</a>	Cable Dia.	Attn. @ 1 GHz	Power @ 1 GHz
1 piece price shown. See web or call for volume pricing.	0.195" dia.	20 dB/100ft	44 W
12" 24" 36" 48"	60"	72"	Custom Len.
\$50.35 \$51.09 \$54.99 \$52.55	\$56.69	\$54.03	See Web

**RG174A/U Coax, 50 Ohm**

Part No. <a href="#">PE3C3425</a>	Cable Dia.	Attn. @ 1 GHz	Power @ 1 GHz
1 piece price shown. See web or call for volume pricing.	0.110" dia.	32 dB/100ft	17 W
12" 24" 36" 48"	60"	72"	Custom Len.
\$43.40 \$43.98 \$44.56 \$41.50	\$45.76	\$42.37	See Web

**RG188A/U Coax, 50 Ohm**

Part No. <a href="#">PE3C2578</a>	Cable Dia.	Attn. @ 1 GHz	Power @ 1 GHz
1 piece price shown. See web or call for volume pricing.	0.110" dia.	26 dB/100ft	160 W
12" 24" 36" 48"	60"	72"	Custom Len.
\$41.17 \$43.39 \$45.60 \$47.83	\$53.80	\$52.26	See Web

**RG223/U Coax, 50 Ohm**

Part No. <a href="#">PE3238</a>	Cable Dia.	Attn. @ 1 GHz	Power @ 1 GHz
1 piece price shown. See web or call for volume pricing.	0.209" dia.	13 dB/100ft	50 W
12" 24" 36" 48"	60"	72"	Custom Len.
\$45.65 \$48.55 \$51.45 \$54.35	\$57.25	\$60.15	See Web

**RG316/U Coax, 50 Ohm**

Part No. <a href="#">PE3C2599</a>	Cable Dia.	Attn. @ 1 GHz	Power @ 1 GHz
1 piece price shown. See web or call for volume pricing.	0.102" dia.	38 dB/100ft	160 W
12" 24" 36" 48"	60"	72"	Custom Len.
\$42.73 \$45.85 \$48.98 \$52.28	\$51.25	\$54.13	See Web

**SMB PLUG TO MCX PLUG**



**Low Loss Flexible Cable Assemblies**

**LMR-100A-PVC Coax, 50 Ohm**

Part No. <a href="#">PE3W04152</a>	Cable Dia.	Attn. @ 1 GHz	Power @ 1 GHz
1 piece price shown. See web or call for volume pricing.	0.110" dia.	24 dB/100ft	W
12" 24" 36" 48"	60"	254CM	Custom Len.
\$34.27 \$35.00 \$35.74 \$36.48	\$37.22	Call	See Web

**SMB PLUG TO SMA MALE**



**Low Loss Flexible Cable Assemblies**

**LMR-100A-PVC Coax, 50 Ohm**

Part No. <a href="#">PE3W04200</a>	Cable Dia.	Attn. @ 1 GHz	Power @ 1 GHz
1 piece price shown. See web or call for volume pricing.	0.110" dia.	24 dB/100ft	W
12" 24" 36" 48"	60"	50CM	Custom Len.
\$39.68 \$40.42 \$41.15 \$41.89	\$42.63	\$40.16	See Web

**SMB PLUG TO SMC PLUG**



**Standard Flexible Cable Assemblies**

**PE-B100 Coax, 50 Ohm**

Part No. <a href="#">PE34501</a>	Cable Dia.	Attn. @ 1 GHz	Power @ 1 GHz
1 piece price shown. See web or call for volume pricing.	0.101" dia.	32 dB/100ft	W
12" 24" 36" 48"	60"	72"	Custom Len.
\$48.27 \$55.12 \$62.01 \$68.86	\$75.75	\$82.60	See Web

**RG58C/U Coax, 50 Ohm**

Part No. <a href="#">PE33641</a>	Cable Dia.	Attn. @ 1 GHz	Power @ 1 GHz
1 piece price shown. See web or call for volume pricing.	0.195" dia.	20 dB/100ft	44 W
12" 24" 36" 48"	60"	72"	Custom Len.
\$63.15 \$63.88 \$64.66 \$65.37	\$66.10	\$66.82	See Web

**RG174A/U Coax, 50 Ohm**

Part No. <a href="#">PE3883</a>	Cable Dia.	Attn. @ 1 GHz	Power @ 1 GHz
1 piece price shown. See web or call for volume pricing.	0.100" dia.	32 dB/100ft	16 W
12" 24" 36" 48"	60"	72"	Custom Len.
\$46.04 \$50.30 \$50.88 \$47.35	\$47.78	\$48.22	See Web

**RG178B/U Coax, 50 Ohm**

Part No. <a href="#">PE3902</a>	Cable Dia.	Attn. @ 1 GHz	Power @ 1 GHz
1 piece price shown. See web or call for volume pricing.	0.072" dia.	44 dB/100ft	78 W
12" 24" 36" 48"	60"	72"	Custom Len.
\$55.64 \$56.60 \$57.56 \$63.33	\$59.47	\$60.44	See Web

**RG188A/U Coax, 50 Ohm**

Part No. <a href="#">PE3595</a>	Cable Dia.	Attn. @ 1 GHz	Power @ 1 GHz
1 piece price shown. See web or call for volume pricing.	0.100" dia.	32 dB/100ft	160 W
12" 24" 36" 48"	60"	72"	Custom Len.
\$49.84 \$49.23 \$51.45 \$53.67	\$55.89	\$58.11	See Web

**RG188-DS Coax, 50 Ohm**

Part No. <a href="#">PE33154</a>	Cable Dia.	Attn. @ 1 GHz	Power @ 1 GHz
1 piece price shown. See web or call for volume pricing.	0.118" dia.	30 dB/100ft	160 W
12" 24" 36" 48"	60"	72"	Custom Len.
\$44.68 \$47.98 \$51.27 \$54.58	\$57.87	\$61.12	See Web

**RG223/U Coax, 50 Ohm**

Part No. <a href="#">PE33647</a>	Cable Dia.	Attn. @ 1 GHz	Power @ 1 GHz
1 piece price shown. See web or call for volume pricing.	0.210" dia.	13 dB/100ft	53 W
12" 24" 36" 48"	60"	72"	Custom Len.
\$61.24 \$64.13 \$67.04 \$69.94	\$72.83	\$75.73	See Web

**RG316/U Coax, 50 Ohm**

Part No. <a href="#">PE3808</a>	Cable Dia.	Attn. @ 1 GHz	Power @ 1 GHz
1 piece price shown. See web or call for volume pricing.	0.098" dia.	38 dB/100ft	160 W
12" 24" 36" 48"	60"	72"	Custom Len.
\$53.78 \$56.90 \$60.02 \$63.33	\$60.44	\$63.33	See Web

**RG316-DS Coax, 50 Ohm**

Part No. <a href="#">PE34721</a>	Cable Dia.	Attn. @ 1 GHz	Power @ 1 GHz
1 piece price shown. See web or call for volume pricing.	0.114" dia.	26 dB/100ft	160 W
12" 24" 36" 48"	60"	72"	Custom Len.
\$48.76 \$51.67 \$54.57 \$57.48	\$60.40	\$67.62	See Web

**SMB PLUG TO SMC PLUG RIGHT ANGLE**



**Standard Flexible Cable Assemblies**

**RG174A/U Coax, 50 Ohm**

Part No. <a href="#">PE33556</a>	Cable Dia.	Attn. @ 1 GHz	Power @ 1 GHz
1 piece price shown. See web or call for volume pricing.	0.100" dia.	32 dB/100ft	16 W
12" 24" 36" 48"	60"	72"	Custom Len.
\$57.66 \$58.24 \$53.31 \$53.74	\$54.22	\$54.64	See Web

**RG178B/U Coax, 50 Ohm**

Part No. <a href="#">PE34492</a>	Cable Dia.	Attn. @ 1 GHz	Power @ 1 GHz
1 piece price shown. See web or call for volume pricing.	0.072" dia.	44 dB/100ft	78 W
12" 24" 36" 48"	60"	72"	Custom Len.
\$61.17 \$67.12 \$63.08 \$64.04	\$65.00	\$65.96	See Web

**RG188A/U Coax, 50 Ohm**

Part No. <a href="#">PE3600</a>	Cable Dia.	Attn. @ 1 GHz	Power @ 1 GHz
1 piece price shown. See web or call for volume pricing.	0.110" dia.	26 dB/100ft	160 W
12" 24" 36" 48"	60"	72"	Custom Len.
\$58.42 \$60.65 \$69.25 \$65.08	\$67.31	\$69.52	See Web

Cable Assemblies

See Our Website For Current Pricing & Real-Time Stock Availability!

For Custom Lengths, Metric Lengths or Special Configurations, Please call (949) 261-1920



Technical Support  
+1 (949) 261-1920



Same-Day Shipping,  
Even Custom Cable Assemblies

For our complete selection of cable assemblies, please visit our website

RG223/U Coax, 50 Ohm				
Part No. <a href="#">PE33664</a>	Cable Dia.	Attn. @ 1 GHz	Power @ 1 GHz	
1 piece price shown. See web or call for volume pricing.				
12"	24"	36"	48"	27
\$59.33	\$62.22	\$65.11	\$68.01	
	60"	72"	Custom Len.	
			\$70.92	\$73.82
				See Web
RG316/U Coax, 50 Ohm				
Part No. <a href="#">PE33363</a>	Cable Dia.	Attn. @ 1 GHz	Power @ 1 GHz	
1 piece price shown. See web or call for volume pricing.				
12"	24"	36"	48"	28
\$66.54	\$63.38	\$66.28	\$69.17	
	60"	72"	Custom Len.	
			\$72.05	\$74.93
				See Web
SMC PLUG TO SMC JACK BULKHEAD				
SEE MOUNTING HOLE SECTION ON PAGE 369				
Standard Flexible Cable Assemblies				
RG58C/U Coax, 50 Ohm				
Part No. <a href="#">PE34503</a>	Cable Dia.	Attn. @ 1 GHz	Power @ 1 GHz	
1 piece price shown. See web or call for volume pricing.				
12"	24"	36"	48"	29
\$66.76	\$67.47	\$68.25	\$68.99	
	60"	72"	Custom Len.	
			\$69.71	\$70.43
				See Web
RG174A/U Coax, 50 Ohm				
Part No. <a href="#">PE33580</a>	Cable Dia.	Attn. @ 1 GHz	Power @ 1 GHz	
1 piece price shown. See web or call for volume pricing.				
12"	24"	36"	48"	30
\$48.51	\$48.95	\$49.38	\$49.82	
	60"	72"	Custom Len.	
			\$50.25	\$50.68
				See Web
RG178B/U Coax, 50 Ohm				
Part No. <a href="#">PE33352</a>	Cable Dia.	Attn. @ 1 GHz	Power @ 1 GHz	
1 piece price shown. See web or call for volume pricing.				
12"	24"	36"	48"	31
\$68.93	\$74.12	\$70.84	\$71.81	
	60"	72"	Custom Len.	
			\$72.76	\$73.72
				See Web
RG316/U Coax, 50 Ohm				
Part No. <a href="#">PE33690</a>	Cable Dia.	Attn. @ 1 GHz	Power @ 1 GHz	
1 piece price shown. See web or call for volume pricing.				
12"	24"	36"	48"	32
\$51.23	\$50.42	\$53.44	\$56.43	
	60"	72"	Custom Len.	
			\$59.44	\$62.43
				See Web
RG316-DS Coax, 50 Ohm				
Part No. <a href="#">PE34511</a>	Cable Dia.	Attn. @ 1 GHz	Power @ 1 GHz	
1 piece price shown. See web or call for volume pricing.				
12"	24"	36"	48"	33
\$51.18	\$59.42	\$57.00	\$65.85	
	60"	72"	Custom Len.	
			\$62.82	\$65.73
				See Web
SMC PLUG RIGHT ANGLE TO BNC MALE				
Standard Flexible Cable Assemblies				
RG174A/U Coax, 50 Ohm				
Part No. <a href="#">PE3C1988</a>	Cable Dia.	Attn. @ 1 GHz	Power @ 1 GHz	
1 piece price shown. See web or call for volume pricing.				
12"	24"	36"	48"	34
\$46.20	\$46.77	\$47.33	\$47.89	
	60"	72"	Custom Len.	
			\$48.45	\$46.57
				See Web
SMC PLUG RIGHT ANGLE TO SMC PLUG RIGHT ANGLE				
Standard Flexible Cable Assemblies				
RG58C/U Coax, 50 Ohm				
Part No. <a href="#">PE33643</a>	Cable Dia.	Attn. @ 1 GHz	Power @ 1 GHz	
1 piece price shown. See web or call for volume pricing.				
12"	24"	36"	48"	35
\$70.17	\$70.90	\$71.63	\$72.37	
	60"	72"	Custom Len.	
			\$80.51	\$73.84
				See Web
RG142B/U Coax, 50 Ohm				
Part No. <a href="#">PE33645</a>	Cable Dia.	Attn. @ 1 GHz	Power @ 1 GHz	
1 piece price shown. See web or call for volume pricing.				
12"	24"	36"	48"	36
\$62.85	\$68.39	\$73.96	\$79.48	
	60"	72"	Custom Len.	
			\$85.00	\$90.60
				See Web
RG174A/U Coax, 50 Ohm				
Part No. <a href="#">PE3918</a>	Cable Dia.	Attn. @ 1 GHz	Power @ 1 GHz	
1 piece price shown. See web or call for volume pricing.				
12"	24"	36"	48"	37
\$62.69	\$63.12	\$63.56	\$63.99	
	60"	72"	Custom Len.	
			\$64.42	\$70.65
				See Web
RG178B/U Coax, 50 Ohm				
Part No. <a href="#">PE3765</a>	Cable Dia.	Attn. @ 1 GHz	Power @ 1 GHz	
1 piece price shown. See web or call for volume pricing.				
12"	24"	36"	48"	38
\$64.99	\$66.05	\$62.09	\$63.06	
	60"	72"	Custom Len.	
			\$64.02	\$64.98
				See Web
RG188A/U Coax, 50 Ohm				
Part No. <a href="#">PE3597</a>	Cable Dia.	Attn. @ 1 GHz	Power @ 1 GHz	
1 piece price shown. See web or call for volume pricing.				
12"	24"	36"	48"	39
\$63.35	\$60.81	\$62.93	\$65.07	
	60"	72"	Custom Len.	
			\$67.23	\$69.35
				See Web
RG316/U Coax, 50 Ohm				

Part No. <a href="#">PE3919</a>				Cable Dia.	Attn. @ 1 GHz	Power @ 1 GHz
1 piece price shown. See web or call for volume pricing.						
12"	24"	36"	48"	0.098" dia.	38 dB/100ft	160 W
\$65.53	\$68.41	\$71.30	\$74.18	60"	72"	Custom Len.
						See Web
RG400/U Coax, 50 Ohm						
Part No. <a href="#">PE34459</a>				Cable Dia.	Attn. @ 1 GHz	Power @ 1 GHz
1 piece price shown. See web or call for volume pricing.						
12"	24"	36"	48"	0.195" dia.	15 dB/100ft	650 W
\$70.29	\$77.32	\$84.35	\$91.37	60"	72"	Custom Len.
						See Web
SMC PLUG RIGHT ANGLE TO SMC JACK BULKHEAD						
SEE MOUNTING HOLE SECTION ON PAGE 369						
Standard Flexible Cable Assemblies						
RG174A/U Coax, 50 Ohm						
Part No. <a href="#">PE34078</a>				Cable Dia.	Attn. @ 1 GHz	Power @ 1 GHz
1 piece price shown. See web or call for volume pricing.						
12"	24"	36"	48"	0.100" dia.	32 dB/100ft	16 W
\$55.48	\$55.89	\$56.38	\$56.79	60"	72"	Custom Len.
						See Web
RG316/U Coax, 50 Ohm						
Part No. <a href="#">PE34472</a>				Cable Dia.	Attn. @ 1 GHz	Power @ 1 GHz
1 piece price shown. See web or call for volume pricing.						
12"	24"	36"	48"	0.098" dia.	38 dB/100ft	160 W
\$58.00	\$60.99	\$64.00	\$67.01	60"	72"	Custom Len.
						See Web
SMC PLUG RIGHT ANGLE TO TNC FEMALE BULKHEAD						
SEE MOUNTING HOLE SECTION ON PAGE 369						
Standard Flexible Cable Assemblies						
RG178B/U Coax, 50 Ohm						
Part No. <a href="#">PE3W05426</a>				Cable Dia.	Attn. @ 1 GHz	Power @ 1 GHz
1 piece price shown. See web or call for volume pricing.						
12"	24"	36"	48"	0.072" dia.	44 dB/100ft	55 W
\$57.87	\$58.99	\$60.13	\$61.26	60"	50CM	Custom Len.
						See Web
SMP MALE BULKHEAD TO SMA MALE						
SEE MOUNTING HOLE SECTION ON PAGE 369						
Standard Formable Cable Assemblies						
PE-SR405FLJ Coax, 50 Ohm						
Part No. <a href="#">PE3W05498</a>				Cable Dia.	Attn. @ 1 GHz	Power @ 1 GHz
1 piece price shown. See web or call for volume pricing.						
12"	24"	36"	48"	0.105" dia.	20 dB/100ft	122 W
\$75.36	\$84.30	\$93.26	\$102.22	60"	50CM	Custom Len.
						See Web
SMP FEMALE TO SMA MALE						
Standard Formable Cable Assemblies						
PE-SR405FL Coax, 50 Ohm						
Part No. <a href="#">PE3W07044</a>				Cable Dia.	Attn. @ 1 GHz	Power @ 1 GHz
1 piece price shown. See web or call for volume pricing.						
12"	24"	36"	48"	" dia.	23 dB/100ft	105 W
\$50.39	\$62.07	\$73.75	\$85.43	60"	50CM	Custom Len.
						See Web
SMP FEMALE TO SMP FEMALE						
Standard Formable Cable Assemblies						
PE-SR407FL Coax, 50 Ohm						
Part No. <a href="#">PE36148</a>				Cable Dia.	Attn. @ 1 GHz	Power @ 1 GHz
1 piece price shown. See web or call for volume pricing.						
12"	24"	36"	48"	0.047" dia.	36 dB/100ft	32 W
\$98.56	\$100.35	\$107.71	\$115.09	60"	72"	Custom Len.
						See Web
PE-SR405FL Coax, 50 Ohm						
Part No. <a href="#">PE36152</a>				Cable Dia.	Attn. @ 1 GHz	Power @ 1 GHz
1 piece price shown. See web or call for volume pricing.						
12"	24"	36"	48"	" dia.	23 dB/100ft	130 W
\$75.21	\$86.56	\$91.66	\$102.04	60"	72"	Custom Len.
						See Web
PE-SR405FL Coax, 50 Ohm						
Part No. <a href="#">PE3C4341</a>				Cable Dia.	Attn. @ 1 GHz	Power @ 1 GHz
1 piece price shown. See web or call for volume pricing.						
12"	24"	36"	48"	" dia.	23 dB/100ft	105 W
\$62.76	\$74.43	\$86.11	\$97.79	60"	50CM	Custom Len.
						See Web
Standard Flexible Cable Assemblies						
PE-P047 Coax, 50 Ohm						
Part No. <a href="#">PE3C0757</a>				Cable Dia.	Attn. @ 1 GHz	Power @ 1 GHz
1 piece price shown. See web or call for volume pricing.						
12"	24"	36"	48"	0.056" dia.	35 dB/100ft	43 W
\$64.40	\$72.17	\$79.94	\$87.71	60"	50CM	Custom Len.
						See Web

Cable Assemblies  
See Our Website For Current Pricing & Real-Time Stock Availability!

\*Coax Performance at 1 GHz Notes: Cable assembly max frequency may be lower than connector or coax max frequency

For our complete selection of cable assemblies, please visit our website

Standard Semi-Rigid Cable Assemblies							
RG405/U Coax, 50 Ohm							
Part No.	PE36150				Cable Dia.	Attn. @ 1 GHz	Power @ 1 GHz
1 piece price shown. See web or call for volume pricing.							
12"	24"	36"	48"	60"	72"	Custom Len.	
\$106.51	\$113.94	\$80.51	\$120.42	\$93.82	\$100.48	See Web	

51

**SMP FEMALE RIGHT ANGLE TO SMP FEMALE RIGHT ANGLE**



**Standard Formable Cable Assemblies**

PE-SR405FL Coax, 50 Ohm							
Part No.	PE36160				Cable Dia.	Attn. @ 1 GHz	Power @ 1 GHz
1 piece price shown. See web or call for volume pricing.							
12"	24"	36"	48"	60"	72"	Custom Len.	
\$86.74	\$97.43	\$114.62	\$118.81	\$129.51	\$140.20	See Web	

52

**PE-SR405FLJ Coax, 50 Ohm**

Part No.	PE3C0438				Cable Dia.	Attn. @ 1 GHz	Power @ 1 GHz
1 piece price shown. See web or call for volume pricing.							
6"	9"	12"	18"	24"	-	Custom Len.	
\$80.84	\$83.62	\$85.70	\$84.72	\$94.24	-	See Web	

53

**Standard Semi-Rigid Cable Assemblies**

RG405/U Coax, 50 Ohm							
Part No.	PE36158				Cable Dia.	Attn. @ 1 GHz	Power @ 1 GHz
1 piece price shown. See web or call for volume pricing.							
12"	24"	36"	48"	60"	72"	Custom Len.	
\$82.79	\$89.66	\$96.52	\$103.40	\$110.26	\$117.14	See Web	

54

**SMP FEMALE RIGHT ANGLE TO MMCX PLUG RIGHT ANGLE**



**Standard Formable Cable Assemblies**

PE-SR405FLJ Coax, 50 Ohm							
Part No.	PE3C3221				Cable Dia.	Attn. @ 1 GHz	Power @ 1 GHz
1 piece price shown. See web or call for volume pricing.							
12"	24"	36"	48"	60"	39.37"	Custom Len.	
\$67.69	\$75.98	\$84.27	\$92.56	\$100.86	Call	See Web	

55

**SMP FEMALE RIGHT ANGLE TO N FEMALE BULKHEAD**

SEE MOUNTING HOLE SECTION ON PAGE 369



**Flexible Cable Assemblies**

LMR-100A-PVC Coax, 50 Ohm							
Part No.	PE3W05673				Cable Dia.	Attn. @ 1 GHz	Power @ 1 GHz
1 piece price shown. See web or call for volume pricing.							
12"	24"	36"	48"	60"	50CM	Custom Len.	
\$53.44	\$54.15	\$54.88	\$55.61	\$56.33	\$53.89	See Web	

56

**SMP FEMALE RIGHT ANGLE TO SMA MALE RIGHT ANGLE**



**Standard Flexible Cable Assemblies**

RG316/U Coax, 50 Ohm							
Part No.	PE3W05056				Cable Dia.	Attn. @ 1 GHz	Power @ 1 GHz
1 piece price shown. See web or call for volume pricing.							
12"	24"	36"	48"	60"	50CM	Custom Len.	
\$57.35	\$60.63	\$63.91	\$67.19	\$70.48	\$59.45	See Web	

57

**SMP FEMALE RIGHT ANGLE TO SMA FEMALE**



**Standard Formable Cable Assemblies**

PE-SR405FL Coax, 50 Ohm							
Part No.	PE3W05740				Cable Dia.	Attn. @ 1 GHz	Power @ 1 GHz
1 piece price shown. See web or call for volume pricing.							
12"	24"	36"	48"	60"	50CM	Custom Len.	
\$70.10	\$81.78	\$93.46	\$105.14	\$116.81	\$77.58	See Web	

58

**SMP FEMALE RIGHT ANGLE TO SMP FEMALE**



**Standard Formable Cable Assemblies**

PE-SR405FL Coax, 50 Ohm							
Part No.	PE3W03777				Cable Dia.	Attn. @ 1 GHz	Power @ 1 GHz
1 piece price shown. See web or call for volume pricing.							
12"	24"	36"	48"	60"	50CM	Custom Len.	
\$76.49	\$88.17	\$99.85	\$111.53	\$123.20	\$83.97	See Web	

59

**SMP FEMALE RIGHT ANGLE TO SMP FEMALE RIGHT ANGLE**



**Standard Flexible Cable Assemblies**

PE-P047 Coax, 50 Ohm							
Part No.	PE3C4969				Cable Dia.	Attn. @ 1 GHz	Power @ 1 GHz
1 piece price shown. See web or call for volume pricing.							
12"	24"	36"	48"	60"	39.37"	Custom Len.	
\$98.81	\$106.57	\$114.34	\$122.11	\$129.89	Call	See Web	

60

**Standard Semi-Rigid Cable Assemblies**

PE-047SR Coax, 50 Ohm							
Part No.	PE3W04802				Cable Dia.	Attn. @ 1 GHz	Power @ 1 GHz
1 piece price shown. See web or call for volume pricing.							
12"	24"	36"	48"	60"	50CM	Custom Len.	
\$57.71	\$68.45	\$79.19	\$89.94	\$100.68	\$64.58	See Web	

61

**SMP FEMALE RIGHT ANGLE TO REVERSE POLARITY TNC FEMALE BULKHEAD**

SEE MOUNTING HOLE SECTION ON PAGE 369



**Flexible Cable Assemblies**

LMR-100A-PVC Coax, 50 Ohm							
Part No.	PE3W05481				Cable Dia.	Attn. @ 1 GHz	Power @ 1 GHz
1 piece price shown. See web or call for volume pricing.							
12"	24"	36"	48"	60"	50CM	Custom Len.	
\$82.93	\$83.65	\$84.38	\$85.10	\$85.83	\$83.39	See Web	

62

**SSMA MALE TO SSMA MALE**



**Standard Flexible Cable Assemblies**

RG174A/U Coax, 50 Ohm							
Part No.	PE3673				Cable Dia.	Attn. @ 1 GHz	Power @ 1 GHz
1 piece price shown. See web or call for volume pricing.							
6"	12"	18"	24"	36"	48"	Custom Len.	
\$64.12	\$64.29	\$64.54	\$64.78	\$65.21	\$65.68	See Web	

63

RG178B/U Coax, 50 Ohm							
Part No.	PE33762				Cable Dia.	Attn. @ 1 GHz	Power @ 1 GHz
1 piece price shown. See web or call for volume pricing.							
6"	12"	18"	24"	36"	48"	Custom Len.	
\$73.44	\$73.44	\$73.92	\$78.90	\$75.37	\$81.08	See Web	

64

RG316/U Coax, 50 Ohm							
Part No.	PE33071				Cable Dia.	Attn. @ 1 GHz	Power @ 1 GHz
1 piece price shown. See web or call for volume pricing.							
6"	12"	18"	24"	36"	48"	Custom Len.	
\$72.23	\$72.23	\$73.67	\$75.11	\$78.00	\$80.89	See Web	

65

**SSMA MALE TO SSMA MALE RIGHT ANGLE**



**Standard Flexible Cable Assemblies**

RG174A/U Coax, 50 Ohm							
Part No.	PE36569				Cable Dia.	Attn. @ 1 GHz	Power @ 1 GHz
1 piece price shown. See web or call for volume pricing.							
6"	12"	18"	24"	36"	48"	Custom Len.	
\$67.77	\$74.82	\$68.25	\$68.44	\$68.92	\$69.35	See Web	

66

RG316/U Coax, 50 Ohm							
Part No.	PE36573				Cable Dia.	Attn. @ 1 GHz	Power @ 1 GHz
1 piece price shown. See web or call for volume pricing.							
6"	12"	18"	24"	36"	48"	Custom Len.	
\$73.25	\$70.54	\$72.03	\$73.54	\$76.54	\$79.54	See Web	

67

**SSMA MALE RIGHT ANGLE TO SSMA MALE RIGHT ANGLE**



**Standard Flexible Cable Assemblies**

RG178B/U Coax, 50 Ohm							
Part No.	PE36572				Cable Dia.	Attn. @ 1 GHz	Power @ 1 GHz
1 piece price shown. See web or call for volume pricing.							
6"	12"	18"	24"	36"	48"	Custom Len.	
\$123.65	\$124.13	\$124.63	\$125.10	\$126.04	\$127.02	See Web	

68

RG316/U Coax, 50 Ohm							
Part No.	PE36574				Cable Dia.	Attn. @ 1 GHz	Power @ 1 GHz
1 piece price shown. See web or call for volume pricing.							
6"	12"	18"	24"	36"	48"	Custom Len.	
\$72.77	\$74.27	\$75.75	\$77.26	\$80.26	\$83.26	See Web	

69

RG316-DS Coax, 50 Ohm							
Part No.	PE38407				Cable Dia.	Attn. @ 1 GHz	Power @ 1 GHz
1 piece price shown. See web or call for volume pricing.							
12"	24"	36"	48"	60"	-	Custom Len.	
\$69.35	\$72.10	\$74.81	\$77.50	\$80.26	-	See Web	

70

Cable Assemblies

See Our Website For Current Pricing & Real-Time Stock Availability!

For Custom Lengths, Metric Lengths or Special Configurations, Please call (949) 261-1920



Technical Support  
+1 (949) 261-1920



Same-Day Shipping,  
Even Custom Cable Assemblies

For our complete selection of cable assemblies, please visit our website

**SSMB PLUG TO SMA MALE**



**Standard Flexible Cable Assemblies**

**RG188-DS Coax, 50 Ohm**

Part No. <a href="#">PE3W06018</a>	Cable Dia.	Attn. @ 1 GHz	Power @ 1 GHz
1 piece price shown. See web or call for volume pricing.			
12"	24"	36"	48"
\$50.99	\$54.69	\$58.39	\$62.09
60"	50CM	Custom Len.	See Web
Part No. <a href="#">PE3W06717</a>	Cable Dia.	Attn. @ 1 GHz	Power @ 1 GHz
1 piece price shown. See web or call for volume pricing.			
12"	24"	36"	48"
\$79.12	\$82.82	\$86.52	\$90.22
60"	50CM	Custom Len.	See Web

**SSMB PLUG TO SSMB PLUG**



**Standard Flexible Cable Assemblies**

**RG188-DS Coax, 50 Ohm**

Part No. <a href="#">PE3W06017</a>	Cable Dia.	Attn. @ 1 GHz	Power @ 1 GHz
1 piece price shown. See web or call for volume pricing.			
12"	24"	36"	48"
\$72.49	\$76.19	\$79.89	\$83.59
60"	50CM	Custom Len.	See Web

**RG196A/U Coax, 50 Ohm**

Part No. <a href="#">PE3122</a>	Cable Dia.	Attn. @ 1 GHz	Power @ 1 GHz
1 piece price shown. See web or call for volume pricing.			
12"	24"	36"	48"
\$76.08	\$83.58	\$78.81	\$80.19
60"	72"	Custom Len.	See Web

**RG316/U Coax, 50 Ohm**

Part No. <a href="#">PE3139</a>	Cable Dia.	Attn. @ 1 GHz	Power @ 1 GHz
1 piece price shown. See web or call for volume pricing.			
12"	24"	36"	48"
\$87.76	\$90.88	\$87.04	\$89.93
60"	72"	Custom Len.	See Web

**SSMB PLUG RIGHT ANGLE TO SSMB PLUG RIGHT ANGLE**



**Standard Flexible Cable Assemblies**

**RG178B/U Coax, 50 Ohm**

Part No. <a href="#">PE3C4801</a>	Cable Dia.	Attn. @ 1 GHz	Power @ 1 GHz
1 piece price shown. See web or call for volume pricing.			
12"	24"	36"	48"
\$53.53	\$54.56	\$55.59	\$56.62
60"	50CM	Custom Len.	See Web

**RG196A/U Coax, 50 Ohm**

Part No. <a href="#">PE3134</a>	Cable Dia.	Attn. @ 1 GHz	Power @ 1 GHz
1 piece price shown. See web or call for volume pricing.			
12"	24"	36"	48"
\$64.92	\$66.30	\$67.66	\$69.03
60"	72"	Custom Len.	See Web

**RG316/U Coax, 50 Ohm**

Part No. <a href="#">PE3157</a>	Cable Dia.	Attn. @ 1 GHz	Power @ 1 GHz
1 piece price shown. See web or call for volume pricing.			
12"	24"	36"	48"
\$85.28	\$88.40	\$86.23	\$89.10
60"	72"	Custom Len.	See Web

**SSMC PLUG TO SMB JACK BULKHEAD**

SEE MOUNTING HOLE SECTION ON PAGE 369



**Standard Flexible Cable Assemblies**

**RG178B/U Coax, 50 Ohm**

Part No. <a href="#">PE3W08023</a>	Cable Dia.	Attn. @ 1 GHz	Power @ 1 GHz
1 piece price shown. See web or call for volume pricing.			
12"	18"	24"	36"
\$61.40	\$61.94	\$62.49	\$63.58
48"	60"	Custom Len.	See Web

**SSMC PLUG TO SSMC PLUG**



**Low Loss Flexible Cable Assemblies**

**LMR-100A-PVC Coax, 50 Ohm**

Part No. <a href="#">PE3C4419</a>	Cable Dia.	Attn. @ 1 GHz	Power @ 1 GHz
1 piece price shown. See web or call for volume pricing.			
6"	12"	18"	24"
\$64.85	\$71.76	\$65.60	\$65.97
36"	48"	Custom Len.	See Web

**Standard Formable Cable Assemblies**

**PE-SR405FLJ Coax, 50 Ohm**

Part No. <a href="#">PE3C4441</a>	Cable Dia.	Attn. @ 1 GHz	Power @ 1 GHz
1 piece price shown. See web or call for volume pricing.			
6"	18"	36"	12"
\$71.64	\$79.18	\$90.46	\$75.41
24"	48"	Custom Len.	See Web

**Standard Flexible Cable Assemblies**

**RG178B/U Coax, 50 Ohm**

Part No. <a href="#">PE3C4388</a>	Cable Dia.	Attn. @ 1 GHz	Power @ 1 GHz
1 piece price shown. See web or call for volume pricing.			
72"	6"	12"	18"
\$79.47	\$78.80	\$74.82	\$79.84
24"	36"	Custom Len.	See Web

**RG316/U Coax, 50 Ohm**

Part No. <a href="#">PE3C4403</a>	Cable Dia.	Attn. @ 1 GHz	Power @ 1 GHz
1 piece price shown. See web or call for volume pricing.			
6"	12"	18"	24"
\$70.67	\$72.08	\$73.49	\$74.87
36"	48"	Custom Len.	See Web

**SSMC PLUG TO SSMC PLUG RIGHT ANGLE**



**Low Loss Flexible Cable Assemblies**

**LMR-100A-PVC Coax, 50 Ohm**

Part No. <a href="#">PE3C4420</a>	Cable Dia.	Attn. @ 1 GHz	Power @ 1 GHz
1 piece price shown. See web or call for volume pricing.			
6"	12"	18"	24"
\$61.43	\$61.80	\$62.17	\$62.54
36"	48"	Custom Len.	See Web

**Standard Flexible Cable Assemblies**

**RG178B/U Coax, 50 Ohm**

Part No. <a href="#">PE3C4455</a>	Cable Dia.	Attn. @ 1 GHz	Power @ 1 GHz
1 piece price shown. See web or call for volume pricing.			
6"	12"	18"	24"
\$65.92	\$66.40	\$66.87	\$67.34
36"	48"	Custom Len.	See Web

**RG316/U Coax, 50 Ohm**

Part No. <a href="#">PE3C4404</a>	Cable Dia.	Attn. @ 1 GHz	Power @ 1 GHz
1 piece price shown. See web or call for volume pricing.			
6"	12"	18"	24"
\$67.23	\$68.65	\$70.05	\$71.44
36"	48"	Custom Len.	See Web

**SSMC PLUG TO SSMC JACK BULKHEAD**

SEE MOUNTING HOLE SECTION ON PAGE 369



**Standard Formable Cable Assemblies**

**PE-SR405FLJ Coax, 50 Ohm**

Part No. <a href="#">PE3C4442</a>	Cable Dia.	Attn. @ 1 GHz	Power @ 1 GHz
1 piece price shown. See web or call for volume pricing.			
6"	12"	18"	24"
\$71.31	\$68.59	\$72.36	\$76.12
36"	48"	Custom Len.	See Web

**Standard Flexible Cable Assemblies**

**RG178B/U Coax, 50 Ohm**

Part No. <a href="#">PE3C4389</a>	Cable Dia.	Attn. @ 1 GHz	Power @ 1 GHz
1 piece price shown. See web or call for volume pricing.			
6"	12"	18"	24"
\$70.36	\$70.84	\$71.31	\$71.77
36"	48"	Custom Len.	See Web

**SSMC PLUG RIGHT ANGLE TO SMA MALE**



**Standard Flexible Cable Assemblies**

**RG188-DS Coax, 50 Ohm**

Part No. <a href="#">PE3W04994</a>	Cable Dia.	Attn. @ 1 GHz	Power @ 1 GHz
1 piece price shown. See web or call for volume pricing.			
12"	24"	36"	48"
\$58.46	\$62.15	\$65.85	\$69.55
60"	50CM	Custom Len.	See Web

**SSMC PLUG RIGHT ANGLE TO SSMC PLUG RIGHT ANGLE**



**Standard Flexible Cable Assemblies**

**RG316/U Coax, 50 Ohm**

Part No. <a href="#">PE3C4374</a>	Cable Dia.	Attn. @ 1 GHz	Power @ 1 GHz
1 piece price shown. See web or call for volume pricing.			
6"	12"	18"	24"
\$63.80	\$65.21	\$66.62	\$68.00
36"	48"	Custom Len.	See Web

**RG316-DS Coax, 50 Ohm**

Part No. <a href="#">PE3C4470</a>	Cable Dia.	Attn. @ 1 GHz	Power @ 1 GHz
1 piece price shown. See web or call for volume pricing.			
6"	12"	18"	24"
\$66.94	\$64.58	\$66.01	\$67.41
36"	48"	Custom Len.	See Web

**SSMC PLUG RIGHT ANGLE TO SSMC JACK BULKHEAD**

SEE MOUNTING HOLE SECTION ON PAGE 369



**Standard Flexible Cable Assemblies**

**RG178B/U Coax, 50 Ohm**

Cable Assemblies See Our Website For Current Pricing & Real-Time Stock Availability!

\*Coax Performance at 1 GHz Notes: Cable assembly max frequency may be lower than connector or coax max frequency

For our complete selection of cable assemblies, please visit our website

Part No. <a href="#">PE3C4458</a>				Cable Dia.	Attn. @ 1 GHz	Power @ 1 GHz	92
1 piece price shown. See web or call for volume pricing.				0.072" dia.	44 dB/100ft	55 W	
6"	12"	18"	24"	36"	48"	Custom Len.	
\$61.96	\$62.43	\$62.89	\$63.36	\$64.29	\$65.23	See Web	

**SSMC PLUG RIGHT ANGLE TO TNC FEMALE BULKHEAD**  
SEE MOUNTING HOLE SECTION ON PAGE 369



**Standard Flexible Cable Assemblies**

RG178B/U Coax, 50 Ohm

Part No. <a href="#">PE3W05518</a>				Cable Dia.	Attn. @ 1 GHz	Power @ 1 GHz	93
1 piece price shown. See web or call for volume pricing.				0.072" dia.	dB/100ft	55 W	
12"	24"	36"	48"	60"	50CM	Custom Len.	
\$60.20	\$61.32	\$62.45	\$63.59	\$64.72	\$60.92	See Web	

**SSMC JACK BULKHEAD TO SSMC JACK RIGHT ANGLE BULKHEAD**  
SEE MOUNTING HOLE SECTION ON PAGE 369



**Standard Flexible Cable Assemblies**

RG178B/U Coax, 50 Ohm

Part No. <a href="#">PE3C4461</a>				Cable Dia.	Attn. @ 1 GHz	Power @ 1 GHz	94
1 piece price shown. See web or call for volume pricing.				0.072" dia.	44 dB/100ft	55 W	
6"	12"	18"	24"	36"	48"	Custom Len.	
\$63.95	\$64.42	\$64.89	\$65.35	\$66.29	\$67.21	See Web	

**SSMC JACK RIGHT ANGLE BULKHEAD TO SSMC JACK RIGHT ANGLE BULKHEAD**  
SEE MOUNTING HOLE SECTION ON PAGE 369



**Standard Flexible Cable Assemblies**

RG178B/U Coax, 50 Ohm

Part No. <a href="#">PE3C4462</a>				Cable Dia.	Attn. @ 1 GHz	Power @ 1 GHz	95
1 piece price shown. See web or call for volume pricing.				0.072" dia.	44 dB/100ft	55 W	
6"	12"	18"	24"	36"	48"	Custom Len.	
\$61.50	\$61.98	\$68.70	\$62.91	\$63.84	\$64.77	See Web	

**TNC MALE TO TNC MALE**



**Standard Flexible Cable Assemblies**

M17/60-RG142-27478 Coax, 50 Ohm

Part No. <a href="#">PE3M0028</a>				Cable Dia.	Attn. @ 1 GHz	Power @ 1 GHz	96
1 piece price shown. See web or call for volume pricing.				0.195" dia.	dB/100ft	W	
12"	18"	24"	30"	36"	48"	Custom Len.	
\$157.19	\$159.91	\$162.65	\$165.37	\$168.10	\$173.55	See Web	

M17/84-RG223-0XDS2 Coax, 50 Ohm

Part No. <a href="#">PE3M0056</a>				Cable Dia.	Attn. @ 1 GHz	Power @ 1 GHz	97
1 piece price shown. See web or call for volume pricing.				0.212" dia.	dB/100ft	W	
12"	18"	24"	30"	36"	48"	Custom Len.	
\$161.49	\$166.36	\$171.25	\$176.12	\$181.00	\$190.76	See Web	

M17/128-RG400-27478 Coax, 50 Ohm

Part No. <a href="#">PE3M0084</a>				Cable Dia.	Attn. @ 1 GHz	Power @ 1 GHz	98
1 piece price shown. See web or call for volume pricing.				0.195" dia.	dB/100ft	W	
12"	18"	24"	30"	36"	48"	Custom Len.	
\$158.68	\$162.15	\$165.62	\$169.09	\$172.56	\$179.50	See Web	

M17/113-RG316-27478 Coax, 50 Ohm

Part No. <a href="#">PE3M0099</a>				Cable Dia.	Attn. @ 1 GHz	Power @ 1 GHz	99
1 piece price shown. See web or call for volume pricing.				0.098" dia.	dB/100ft	W	
6"	8"	12"	16"	18"	24"	Custom Len.	
\$188.33	\$188.66	\$189.34	\$189.96	\$190.33	\$191.34	See Web	

M17/119-RG174-0XDS2 Coax, 50 Ohm

Part No. <a href="#">PE3M0114</a>				Cable Dia.	Attn. @ 1 GHz	Power @ 1 GHz	1
1 piece price shown. See web or call for volume pricing.				0.110" dia.	dB/100ft	W	
6"	8"	12"	16"	18"	24"	Custom Len.	
\$187.72	\$187.84	\$188.11	\$188.36	\$188.50	\$188.89	See Web	

M17/28-RG058-0XDS2 Coax, 50 Ohm

Part No. <a href="#">PE3M0124</a>				Cable Dia.	Attn. @ 1 GHz	Power @ 1 GHz	2
1 piece price shown. See web or call for volume pricing.				0.195" dia.	dB/100ft	W	
12"	18"	24"	30"	36"	48"	Custom Len.	
\$259.93	\$260.52	\$261.12	\$261.71	\$262.32	\$263.51	See Web	

**TNC MALE TO BNC MALE**



**Low Loss Flexible Cable Assemblies**

PE-C195 Coax, 50 Ohm

Part No. <a href="#">PE37885</a>				Cable Dia.	Attn. @ 1 GHz	Power @ 1 GHz	3
1 piece price shown. See web or call for volume pricing.				0.195" dia.	11 dB/100ft	150 W	
12"	24"	36"	48"	60"	-	Custom Len.	
\$30.92	\$31.64	\$32.35	\$35.78	\$36.58	-	See Web	

PE-C240 Coax, 50 Ohm

Part No. <a href="#">PE37594</a>				Cable Dia.	Attn. @ 1 GHz	Power @ 1 GHz	4
1 piece price shown. See web or call for volume pricing.				0.240" dia.	9 dB/100ft	250 W	
12"	24"	36"	48"	60"	-	Custom Len.	
\$41.18	\$41.67	\$44.49	\$47.25	\$50.07	-	See Web	

**Standard Flexible Cable Assemblies**

RG58C/U Coax, 50 Ohm

Part No. <a href="#">PE3497</a>				Cable Dia.	Attn. @ 1 GHz	Power @ 1 GHz	5
1 piece price shown. See web or call for volume pricing.				0.195" dia.	20 dB/100ft	44 W	
12"	24"	36"	48"	60"	72"	Custom Len.	
\$37.12	\$37.94	\$38.75	\$37.24	\$37.98	\$41.27	See Web	

RG58-P Coax, 50 Ohm

Part No. <a href="#">PE35789</a>				Cable Dia.	Attn. @ 1 GHz	Power @ 1 GHz	6
1 piece price shown. See web or call for volume pricing.				0.159" dia.	17 dB/100ft	632 W	
12"	24"	36"	48"	60"	-	Custom Len.	
\$49.65	\$54.64	\$59.65	\$64.64	\$69.64	-	See Web	

RG142B/U Coax, 50 Ohm

Part No. <a href="#">PE3551</a>				Cable Dia.	Attn. @ 1 GHz	Power @ 1 GHz	7
1 piece price shown. See web or call for volume pricing.				0.195" dia.	13 dB/100ft	650 W	
12"	24"	36"	48"	60"	72"	Custom Len.	
\$40.37	\$46.10	\$54.94	\$57.57	\$63.30	\$69.03	See Web	

RG174A/U Coax, 50 Ohm

Part No. <a href="#">PE3C3400</a>				Cable Dia.	Attn. @ 1 GHz	Power @ 1 GHz	8
1 piece price shown. See web or call for volume pricing.				0.110" dia.	32 dB/100ft	17 W	
12"	24"	36"	48"	60"	72"	Custom Len.	
\$44.39	\$44.83	\$45.25	\$45.65	\$46.11	\$46.52	See Web	

RG188A/U Coax, 50 Ohm

Part No. <a href="#">PE3C3401</a>				Cable Dia.	Attn. @ 1 GHz	Power @ 1 GHz	9
1 piece price shown. See web or call for volume pricing.				0.110" dia.	26 dB/100ft	160 W	
12"	24"	36"	48"	60"	72"	Custom Len.	
\$46.00	\$48.07	\$55.59	\$52.18	\$54.26	\$56.28	See Web	

RG213/U Coax, 50 Ohm

Part No. <a href="#">PE33969</a>				Cable Dia.	Attn. @ 1 GHz	Power @ 1 GHz	10
1 piece price shown. See web or call for volume pricing.				0.405" dia.	8 dB/100ft	190 W	
12"	24"	36"	48"	60"	72"	Custom Len.	
\$72.04	\$73.71	\$75.37	\$77.03	\$78.69	\$80.36	See Web	

RG214/U Coax, 50 Ohm

Part No. <a href="#">PE33701</a>				Cable Dia.	Attn. @ 1 GHz	Power @ 1 GHz	11
1 piece price shown. See web or call for volume pricing.				0.425" dia.	7 dB/100ft	190 W	
12"	24"	36"	48"	60"	72"	Custom Len.	
\$82.47	\$89.79	\$97.12	\$104.45	\$111.77	\$127.07	See Web	

RG223/U Coax, 50 Ohm

Part No. <a href="#">PE3498</a>				Cable Dia.	Attn. @ 1 GHz	Power @ 1 GHz	12
1 piece price shown. See web or call for volume pricing.				0.210" dia.	13 dB/100ft	53 W	
12"	24"	36"	48"	60"	72"	Custom Len.	
\$36.85	\$43.65	\$46.77	\$50.06	\$48.45	\$56.41	See Web	

RG316/U Coax, 50 Ohm

Part No. <a href="#">PE3C3393</a>				Cable Dia.	Attn. @ 1 GHz	Power @ 1 GHz	13
1 piece price shown. See web or call for volume pricing.				0.102" dia.	38 dB/100ft	160 W	
12"	24"	36"	48"	60"	72"	Custom Len.	
\$45.82	\$48.71	\$54.82	\$58.12	\$57.37	\$60.26	See Web	

RG393/U Coax, 50 Ohm

Part No. <a href="#">PE37859</a>				Cable Dia.	Attn. @ 1 GHz	Power @ 1 GHz	14
1 piece price shown. See web or call for volume pricing.				0.390" dia.	9 dB/100ft	1700 W	
12"	24"	36"	48"	60"	-	Custom Len.	
\$75.94	\$96.91	\$104.81	\$119.27	\$133.68	-	See Web	

RG400/U Coax, 50 Ohm

Part No. <a href="#">PE33535</a>				Cable Dia.	Attn. @ 1 GHz	Power @ 1 GHz	15
1 piece price shown. See web or call for volume pricing.				0.195" dia.	15 dB/100ft	650 W	
12"	24"	36"	48"	60"	72"	Custom Len.	
\$48.63	\$58.94	\$62.56	\$74.15	\$81.70	\$89.24	See Web	

PE-P195 Coax, 50 Ohm

Part No. <a href="#">PE37478</a>				Cable Dia.	Attn. @ 1 GHz	Power @ 1 GHz	16
1 piece price shown. See web or call for volume pricing.				0.195" dia.	13 dB/100ft	650 W	
12"	24"	36"	48"	60"	-	Custom Len.	
\$40.83	\$49.06	\$57.21	\$65.37	\$73.54	-	See Web	

RG59B/U Coax, 75 Ohm

Part No. <a href="#">PE3023</a>				Cable Dia.	Attn. @ 1 GHz	Power @ 1 GHz	17
1 piece price shown. See web or call for volume pricing.				0.242" dia.	12 dB/100ft	77 W	
12"	24"	36"	48"	60"	72"	Custom Len.	
\$35.21	\$38.36	\$39.40	\$38.09	\$39.05	\$42.62	See Web	

**TNC MALE TO MINI UHF MALE**



**Low Loss Flexible Cable Assemblies**

LMR-195 Coax, 50 Ohm

Part No. <a href="#">PE3C0047</a>				Cable Dia.	Attn. @ 1 GHz	Power @ 1 GHz	18
1 piece price shown. See web or call for volume pricing.				0.195" dia.	12 dB/100ft	W	
12"	24"	36"	48"	60"	-	Custom Len.	
\$29.99	\$30.73	\$31.48	\$32.22	\$32.97	-	See Web	

For Custom Lengths, Metric Lengths or Special Configurations, Please call (949) 261-1920



Technical Support  
+1 (949) 261-1920



Same-Day Shipping,  
Even Custom Cable Assemblies

Cable Assemblies

See Our Website For Current Pricing & Real-Time Stock Availability!

For our complete selection of cable assemblies, please visit our website

**TNC MALE TO N MALE**



**Flexible Cable Assemblies**

**LMR-195 Coax, 50 Ohm**

Part No.	PE3W01959	Cable Dia.	Attn. @ 1 GHz	Power @ 1 GHz
1 piece price shown. See web or call for volume pricing.				
12"	24"	36"	48"	60"
\$44.37	\$45.09	\$45.82	\$46.55	\$47.27

**Low Loss Flexible Cable Assemblies**

**LMR-240 Coax, 50 Ohm**

Part No.	PE3W04201	Cable Dia.	Attn. @ 1 GHz	Power @ 1 GHz
1 piece price shown. See web or call for volume pricing.				
12"	24"	36"	48"	60"
\$40.50	\$41.37	\$42.26	\$43.14	\$44.02

**PE-P142LL-27478 Coax, 50 Ohm**

Part No.	PE3M0162	Cable Dia.	Attn. @ 1 GHz	Power @ 1 GHz
1 piece price shown. See web or call for volume pricing.				
12"	18"	24"	36"	48"
\$378.40	\$386.88	\$395.36	\$412.32	\$429.27

**PE-P160LL-27478 Coax, 50 Ohm**

Part No.	PE3M0207	Cable Dia.	Attn. @ 1 GHz	Power @ 1 GHz
1 piece price shown. See web or call for volume pricing.				
8"	12"	18"	24"	30"
\$353.68	\$358.58	\$365.93	\$373.28	\$380.63

**PE-P300LL-27478 Coax, 50 Ohm**

Part No.	PE3M0240	Cable Dia.	Attn. @ 1 GHz	Power @ 1 GHz
1 piece price shown. See web or call for volume pricing.				
12"	18"	24"	36"	48"
\$414.08	\$428.23	\$442.39	\$470.69	\$498.99

**TNC MALE TO N MALE RIGHT ANGLE**



**Low Loss Flexible Cable Assemblies**

**PE-P142LL-27478 Coax, 50 Ohm**

Part No.	PE3M0164	Cable Dia.	Attn. @ 1 GHz	Power @ 1 GHz
1 piece price shown. See web or call for volume pricing.				
12"	18"	24"	36"	48"
\$493.43	\$501.91	\$510.39	\$527.34	\$544.30

**PE-P160LL-27478 Coax, 50 Ohm**

Part No.	PE3M0209	Cable Dia.	Attn. @ 1 GHz	Power @ 1 GHz
1 piece price shown. See web or call for volume pricing.				
8"	12"	18"	24"	30"
\$451.74	\$456.63	\$463.99	\$471.33	\$478.69

**PE-P300LL-27478 Coax, 50 Ohm**

Part No.	PE3M0242	Cable Dia.	Attn. @ 1 GHz	Power @ 1 GHz
1 piece price shown. See web or call for volume pricing.				
12"	18"	24"	36"	48"
\$559.02	\$573.17	\$587.33	\$615.63	\$643.93

**TNC MALE TO N FEMALE BULKHEAD**



SEE MOUNTING HOLE SECTION ON PAGE 369

**Low Loss Flexible Cable Assemblies**

**PE-P142LL-27478 Coax, 50 Ohm**

Part No.	PE3M0163	Cable Dia.	Attn. @ 1 GHz	Power @ 1 GHz
1 piece price shown. See web or call for volume pricing.				
12"	18"	24"	36"	48"
\$465.61	\$474.09	\$482.56	\$499.52	\$516.48

**PE-P160LL-27478 Coax, 50 Ohm**

Part No.	PE3M0208	Cable Dia.	Attn. @ 1 GHz	Power @ 1 GHz
1 piece price shown. See web or call for volume pricing.				
8"	12"	18"	24"	30"
\$455.66	\$460.57	\$467.92	\$475.27	\$482.63

**PE-P300LL-27478 Coax, 50 Ohm**

Part No.	PE3M0241	Cable Dia.	Attn. @ 1 GHz	Power @ 1 GHz
1 piece price shown. See web or call for volume pricing.				
12"	18"	24"	36"	48"
\$489.75	\$503.90	\$518.06	\$546.36	\$574.66

**TNC MALE TO SMA MALE**



**Low Loss Flexible Cable Assemblies**

**LMR-195-FR Coax, 50 Ohm**

Part No.	PE3W04028	Cable Dia.	Attn. @ 1 GHz	Power @ 1 GHz
1 piece price shown. See web or call for volume pricing.				
12"	24"	36"	48"	60"
\$27.94	\$39.76	\$40.76	\$41.76	\$42.75

**TNC MALE TO SMA MALE RIGHT ANGLE**



**Flexible Cable Assemblies**

**LMR-200 Coax, 50 Ohm**

Part No.	PE3W07265	Cable Dia.	Attn. @ 1 GHz	Power @ 1 GHz
1 piece price shown. See web or call for volume pricing.				
12"	24"	36"	48"	60"
\$60.05	\$60.77	\$61.49	\$62.20	\$62.92

**TNC MALE TO SMB PLUG RIGHT ANGLE**



**Standard Flexible Cable Assemblies**

**RG174AU Coax, 50 Ohm**

Part No.	PE3W00322	Cable Dia.	Attn. @ 1 GHz	Power @ 1 GHz
1 piece price shown. See web or call for volume pricing.				
12"	24"	36"	48"	60"
\$48.38	\$48.93	\$49.48	\$50.04	\$50.59

**TNC MALE TO SMP FEMALE RIGHT ANGLE**



**Standard Flexible Cable Assemblies**

**RG316/U Coax, 50 Ohm**

Part No.	PE3W05738	Cable Dia.	Attn. @ 1 GHz	Power @ 1 GHz
1 piece price shown. See web or call for volume pricing.				
12"	24"	36"	48"	60"
\$56.41	\$59.68	\$62.96	\$66.25	\$69.53

**TNC MALE TO TNC MALE**



**Flexible Cable Assemblies**

**LMR-195-FR Coax, 50 Ohm**

Part No.	PE3W05242	Cable Dia.	Attn. @ 1 GHz	Power @ 1 GHz
1 piece price shown. See web or call for volume pricing.				
12"	24"	36"	48"	60"
\$25.66	\$26.66	\$27.66	\$28.66	\$29.65

**Precision Formable Cable Assemblies**

**PE-SR402FL Coax, 50 Ohm**

Part No.	PE39479	Cable Dia.	Attn. @ 1 GHz	Power @ 1 GHz
1 piece price shown. See web or call for volume pricing.				
6"	9"	12"	18"	24"
\$53.54	\$30.02	\$57.47	\$47.63	\$51.34

**Low Loss Flexible Cable Assemblies**

**PE-C195 Coax, 50 Ohm**

Part No.	PE36555	Cable Dia.	Attn. @ 1 GHz	Power @ 1 GHz
1 piece price shown. See web or call for volume pricing.				
12"	24"	36"	48"	60"
\$38.73	\$39.51	\$36.65	\$41.12	\$41.92

**PE-C240 Coax, 50 Ohm**

Part No.	PE35997	Cable Dia.	Attn. @ 1 GHz	Power @ 1 GHz
1 piece price shown. See web or call for volume pricing.				
12"	24"	36"	48"	60"
\$44.48	\$42.93	\$44.49	\$47.25	\$49.11

**PE-C300 Coax, 50 Ohm**

Part No.	PE35100	Cable Dia.	Attn. @ 1 GHz	Power @ 1 GHz
1 piece price shown. See web or call for volume pricing.				
12"	24"	36"	48"	60"
\$58.42	\$61.26	\$64.09	\$66.92	\$69.76

**PE-C400 Coax, 50 Ohm**

Part No.	PE35886	Cable Dia.	Attn. @ 1 GHz	Power @ 1 GHz
1 piece price shown. See web or call for volume pricing.				
12"	24"	36"	48"	60"
\$90.87	\$87.04	\$90.46	\$95.27	\$96.94

**LMR-100A-PVC Coax, 50 Ohm**

Part No.	PE3C0115	Cable Dia.	Attn. @ 1 GHz	Power @ 1 GHz
1 piece price shown. See web or call for volume pricing.				
12"	24"	36"	48"	60"
\$58.32	\$59.08	\$63.34	\$64.14	\$64.92

**LMR-400-DB Coax, 50 Ohm**

Part No.	PE3W00572	Cable Dia.	Attn. @ 1 GHz	Power @ 1 GHz
1 piece price shown. See web or call for volume pricing.				
12"	24"	36"	48"	60"
\$79.12	\$80.56	\$82.01	\$83.44	\$84.89

**LMR-195 Coax, 50 Ohm**

Cable Assemblies See Our Website For Current Pricing & Real-Time Stock Availability!

\*Coax Performance at 1 GHz Notes: Cable assembly max frequency may be lower than connector or coax max frequency



# For our complete selection of cable assemblies, please visit our website

Part No.	Cable Dia.				Attn. @ 1 GHz	Power @ 1 GHz
<b>PE3C0042</b>	0.195" dia.				12 dB/100ft	W
1 piece price shown. See web or call for volume pricing.						
12"	24"	36"	48"	60"	-	Custom Len.
\$35.86	\$36.60	\$37.36	\$38.15	\$38.91	-	See Web
<b>PE3C0117</b>	0.195" dia.				12 dB/100ft	W
1 piece price shown. See web or call for volume pricing.						
12"	24"	36"	48"	60"	-	Custom Len.
\$50.64	\$53.41	\$54.16	\$54.95	\$53.63	-	See Web
<b>PE-P142LL-27478 Coax, 50 Ohm</b>						
<b>PE3M0159</b>	0.195" dia.				dB/100ft	W
1 piece price shown. See web or call for volume pricing.						
12"	18"	24"	36"	48"	60"	Custom Len.
\$386.76	\$395.24	\$403.71	\$420.67	\$437.63	\$454.58	See Web
<b>PE-P160LL-27478 Coax, 50 Ohm</b>						
<b>PE3M0204</b>	0.160" dia.				dB/100ft	W
1 piece price shown. See web or call for volume pricing.						
8"	12"	18"	24"	30"	36"	Custom Len.
\$366.73	\$371.62	\$378.98	\$386.32	\$393.68	\$401.02	See Web
<b>PE-P300LL-27478 Coax, 50 Ohm</b>						
<b>PE3M0238</b>	0.300" dia.				dB/100ft	W
1 piece price shown. See web or call for volume pricing.						
12"	18"	24"	36"	48"	60"	Custom Len.
\$410.09	\$424.24	\$438.40	\$466.70	\$495.00	\$523.30	See Web
<b>PE-P160LL Coax, 50 Ohm</b>						
<b>PE3C5249</b>	0.160" dia.				dB/100ft	W
1 piece price shown. See web or call for volume pricing.						
12"	24"	36"	48"	60"	50CM	Custom Len.
\$205.44	\$226.16	\$246.87	\$267.58	\$288.29	\$218.71	See Web
<b>Low Loss Test Flexible Cable Assemblies</b>						
<b>PE-P300LL Coax, 50 Ohm</b>						
<b>PE3334</b>	0.300" dia.				5 dB/100ft	W
1 piece price shown. See web or call for volume pricing.						
12"	24"	36"	48"	60"	50CM	Custom Len.
\$314.04	\$339.97	\$365.92	\$391.86	\$417.78	\$330.66	See Web
<b>PE-P142LL Coax, 50 Ohm</b>						
<b>PE347</b>	0.195" dia.				7 dB/100ft	W
1 piece price shown. See web or call for volume pricing.						
12"	24"	36"	48"	60"	50CM	Custom Len.
\$155.85	\$172.09	\$188.33	\$204.56	\$220.80	\$166.25	See Web
<b>Standard Formable Cable Assemblies</b>						
<b>PE-SR401FL Coax, 50 Ohm</b>						
<b>PE34282</b>	" dia.				8 dB/100ft	1400 W
1 piece price shown. See web or call for volume pricing.						
6"	12"	18"	24"	36"	48"	Custom Len.
\$170.58	\$170.58	\$178.29	\$185.99	\$201.39	\$216.80	See Web
<b>PE-SR402FL Coax, 50 Ohm</b>						
<b>PE3466</b>	" dia.				12 dB/100ft	450 W
1 piece price shown. See web or call for volume pricing.						
6"	12"	18"	24"	36"	48"	Custom Len.
\$92.60	\$92.60	\$96.36	\$100.13	\$114.31	\$122.86	See Web
<b>Standard Flexible Cable Assemblies</b>						
<b>RG8A/U Coax, 50 Ohm</b>						
<b>PE3418</b>	0.405" dia.				8 dB/100ft	190 W
1 piece price shown. See web or call for volume pricing.						
12"	24"	36"	48"	60"	72"	Custom Len.
\$66.70	\$65.62	\$68.39	\$71.08	\$73.84	\$76.61	See Web
<b>RG8X Coax, 50 Ohm</b>						
<b>PE35671</b>	0.242" dia.				14 dB/100ft	60 W
1 piece price shown. See web or call for volume pricing.						
12"	24"	36"	48"	60"	-	Custom Len.
\$66.46	\$70.00	\$67.12	\$69.94	\$72.77	-	See Web
<b>RG58C/U Coax, 50 Ohm</b>						
<b>PE3394</b>	0.195" dia.				20 dB/100ft	44 W
1 piece price shown. See web or call for volume pricing.						
12"	18"	24"	30"	36"	48"	Custom Len.
\$37.05	\$37.46	\$37.86	\$38.28	\$38.68	\$39.54	See Web
<b>RG142B/U Coax, 50 Ohm</b>						
<b>PE3544</b>	0.195" dia.				13 dB/100ft	650 W
1 piece price shown. See web or call for volume pricing.						
12"	24"	36"	48"	60"	72"	Custom Len.
\$47.76	\$53.84	\$59.92	\$66.35	\$72.54	\$78.75	See Web
<b>RG174A/U Coax, 50 Ohm</b>						
<b>PE3425</b>	0.100" dia.				32 dB/100ft	16 W
1 piece price shown. See web or call for volume pricing.						
12"	24"	36"	48"	60"	72"	Custom Len.
\$62.41	\$62.85	\$67.32	\$67.93	\$64.15	\$64.58	See Web
<b>RG188A/U Coax, 50 Ohm</b>						
<b>PE3434</b>	0.110" dia.				26 dB/100ft	160 W
1 piece price shown. See web or call for volume pricing.						
12"	24"	36"	48"	60"	72"	Custom Len.
\$63.17	\$65.38	\$67.61	\$69.82	\$72.03	\$74.26	See Web

Part No.	Cable Dia.				Attn. @ 1 GHz	Power @ 1 GHz
<b>PE3421</b>	0.405" dia.				8 dB/100ft	190 W
1 piece price shown. See web or call for volume pricing.						
12"	24"	36"	48"	60"	72"	Custom Len.
\$66.80	\$68.46	\$70.11	\$71.78	\$73.44	\$75.11	See Web
<b>RG214/U Coax, 50 Ohm</b>						
<b>PE3435</b>	0.425" dia.				7 dB/100ft	190 W
1 piece price shown. See web or call for volume pricing.						
12"	24"	36"	48"	60"	72"	Custom Len.
\$89.99	\$103.16	\$110.94	\$119.18	\$119.29	\$135.04	See Web
<b>RG23/U Coax, 50 Ohm</b>						
<b>PE3414</b>	0.210" dia.				13 dB/100ft	53 W
1 piece price shown. See web or call for volume pricing.						
12"	24"	36"	48"	60"	72"	Custom Len.
\$46.53	\$49.63	\$52.75	\$56.04	\$59.22	\$62.39	See Web
<b>RG303/U Coax, 50 Ohm</b>						
<b>PE33013</b>	0.170" dia.				14 dB/100ft	650 W
1 piece price shown. See web or call for volume pricing.						
12"	24"	36"	48"	60"	-	Custom Len.
\$41.92	\$48.36	\$51.01	\$56.75	\$68.16	-	See Web
<b>RG316/U Coax, 50 Ohm</b>						
<b>PE3747</b>	0.098" dia.				38 dB/100ft	160 W
1 piece price shown. See web or call for volume pricing.						
12"	24"	36"	48"	60"	72"	Custom Len.
\$64.06	\$66.95	\$69.83	\$78.75	\$75.62	\$85.11	See Web
<b>RG316-DS Coax, 50 Ohm</b>						
<b>PE34316</b>	0.114" dia.				26 dB/100ft	160 W
1 piece price shown. See web or call for volume pricing.						
12"	24"	36"	48"	60"	-	Custom Len.
\$58.43	\$61.34	\$69.35	\$67.16	\$70.07	-	See Web
<b>RG393/U Coax, 50 Ohm</b>						
<b>PE33185</b>	0.390" dia.				8 dB/100ft	1700 W
1 piece price shown. See web or call for volume pricing.						
12"	24"	36"	48"	60"	-	Custom Len.
\$95.58	\$111.98	\$121.10	\$145.75	\$152.03	-	See Web
<b>RG40/U Coax, 50 Ohm</b>						
<b>PE3608</b>	0.195" dia.				15 dB/100ft	650 W
1 piece price shown. See web or call for volume pricing.						
12"	24"	36"	48"	60"	72"	Custom Len.
\$57.17	\$61.93	\$71.95	\$75.87	\$87.32	\$94.85	See Web
<b>PE-P141EAM Coax, 50 Ohm</b>						
<b>PE3CA1043</b>	0.163" dia.				dB/100ft	W
1 piece price shown. See web or call for volume pricing.						
12"	24"	36"	-	-	-	Custom Len.
\$255.96	\$296.80	\$288.60	-	-	-	See Web
<b>PE-P195 Coax, 50 Ohm</b>						
<b>PE35711</b>	0.195" dia.				13 dB/100ft	650 W
1 piece price shown. See web or call for volume pricing.						
12"	24"	36"	48"	60"	-	Custom Len.
\$48.52	\$56.68	\$70.59	\$73.01	\$81.23	-	See Web
<b>LMR-400-UF Coax, 50 Ohm</b>						
<b>PE3W00808</b>	0.405" dia.				5 dB/100ft	W
1 piece price shown. See web or call for volume pricing.						
12"	24"	36"	48"	60"	50CM	Custom Len.
\$80.31	\$82.87	\$85.43	\$87.98	\$90.54	\$81.96	See Web
<b>Standard Semi-Rigid Cable Assemblies</b>						
<b>PE-SR402AL Coax, 50 Ohm</b>						
<b>PE34279</b>	0.141" dia.				13 dB/100ft	450 W
1 piece price shown. See web or call for volume pricing.						
6"	12"	18"	24"	36"	48"	Custom Len.
\$84.60	\$89.15	\$93.71	\$98.27	\$107.40	\$116.50	See Web
<b>RG401/U Coax, 50 Ohm</b>						
<b>PE34271</b>	" dia.				8 dB/100ft	870 W
1 piece price shown. See web or call for volume pricing.						
6"	12"	18"	24"	36"	48"	Custom Len.
\$173.00	\$184.01	\$177.96	\$188.59	\$209.90	\$253.33	See Web
<b>RG402/U Coax, 50 Ohm</b>						
<b>PE3074</b>	" dia.				11 dB/100ft	450 W
1 piece price shown. See web or call for volume pricing.						
6"	12"	18"	24"	36"	48"	Custom Len.
\$92.33	\$92.33	\$95.97	\$99.63	\$113.51	\$114.24	See Web
<b>PE-SR401AL-STRAIGHT Coax, 50 Ohm</b>						
<b>PE34275</b>	0.250" dia.				8 dB/100ft	1400 W
1 piece price shown. See web or call for volume pricing.						
6"	12"	18"	24"	36"	48"	Custom Len.
\$154.80	\$163.57	\$172.38	\$181.16	\$198.74	\$216.32	See Web
<b>Standard Flexible Cable Assemblies</b>						
<b>RG55B/U Coax, 53 Ohm</b>						
<b>PE3504</b>	0.202" dia.				17 dB/100ft	53 W
1 piece price shown. See web or call for volume pricing.						
12"	24"	36"	48"	60"	72"	Custom Len.
\$43.00	\$45.25	\$47.49	\$49.73	\$51.97	\$54.22	See Web

Cable Assemblies

See Our Website For Current Pricing & Real-Time Stock Availability!

For Custom Lengths, Metric Lengths or Special Configurations, Please call (949) 261-1920



Technical Support  
+1 (949) 261-1920



Same-Day Shipping,  
Even Custom Cable Assemblies

For our complete selection of cable assemblies, please visit our website

Cable Assemblies  
See Our Website For Current Pricing & Real-Time Stock Availability!

RG59B/U Coax, 75 Ohm				
Part No. <b>PE3402</b>	Cable Dia.	Attn. @ 1 GHz	Power @ 1 GHz	74
1 piece price shown. See web or call for volume pricing.	0.242" dia.	12 dB/100ft	77 W	
12" 18" 24" 30"	36" 48"	Custom Len.		
\$37.42 \$37.91 \$40.71 \$38.86	\$39.35 \$40.30	See Web		
RG179B/U Coax, 75 Ohm				
Part No. <b>PE3430</b>	Cable Dia.	Attn. @ 1 GHz	Power @ 1 GHz	75
1 piece price shown. See web or call for volume pricing.	0.100" dia.	25 dB/100ft	200 W	
12" 24" 36" 48"	60" 72"	Custom Len.		
\$63.41 \$65.79 \$68.15 \$70.51	\$72.88 \$75.23	See Web		
RG62A/U Coax, 93 Ohm				
Part No. <b>PE3408</b>	Cable Dia.	Attn. @ 1 GHz	Power @ 1 GHz	76
1 piece price shown. See web or call for volume pricing.	0.242" dia.	13 dB/100ft	77 W	
12" 24" 36" 48"	60" 72"	Custom Len.		
\$37.88 \$39.25 \$43.99 \$42.00	\$43.37 \$44.74	See Web		
TNC MALE TO TNC MALE RIGHT ANGLE				
Precision Formable Cable Assemblies				
PE-SR402FL Coax, 50 Ohm				
Part No. <b>PE39481</b>	Cable Dia.	Attn. @ 1 GHz	Power @ 1 GHz	77
1 piece price shown. See web or call for volume pricing.	" dia.	12 dB/100ft	450 W	
6" 9" 12" 18"	24"	Custom Len.		
\$50.83 \$44.47 \$46.36 \$59.74	\$58.15	See Web		
Low Loss Flexible Cable Assemblies				
LMR-195 Coax, 50 Ohm				
Part No. <b>PE3C0058</b>	Cable Dia.	Attn. @ 1 GHz	Power @ 1 GHz	78
1 piece price shown. See web or call for volume pricing.	0.195" dia.	12 dB/100ft	W	
12" 24" 36" 48"	60"	Custom Len.		
\$46.81 \$50.36 \$51.12 \$51.91	\$52.67	See Web		
PE-P142LL-27478 Coax, 50 Ohm				
Part No. <b>PE3M0161</b>	Cable Dia.	Attn. @ 1 GHz	Power @ 1 GHz	79
1 piece price shown. See web or call for volume pricing.	0.195" dia.	dB/100ft	W	
12" 18" 24" 36"	48" 60"	Custom Len.		
\$493.43 \$501.91 \$510.39 \$527.34	\$544.30 \$561.26	See Web		
PE-P160LL-27478 Coax, 50 Ohm				
Part No. <b>PE3M0206</b>	Cable Dia.	Attn. @ 1 GHz	Power @ 1 GHz	80
1 piece price shown. See web or call for volume pricing.	0.160" dia.	dB/100ft	W	
8" 12" 18" 24"	30" 36"	Custom Len.		
\$451.74 \$456.63 \$463.99 \$471.33	\$478.69 \$486.03	See Web		
PE-P300LL-27478 Coax, 50 Ohm				
Part No. <b>PE3M0239</b>	Cable Dia.	Attn. @ 1 GHz	Power @ 1 GHz	81
1 piece price shown. See web or call for volume pricing.	0.300" dia.	dB/100ft	W	
12" 18" 24" 36"	48" 60"	Custom Len.		
\$554.38 \$568.53 \$582.68 \$610.98	\$639.29 \$667.59	See Web		
PE-P160LL Coax, 50 Ohm				
Part No. <b>PE3C5252</b>	Cable Dia.	Attn. @ 1 GHz	Power @ 1 GHz	82
1 piece price shown. See web or call for volume pricing.	0.160" dia.	dB/100ft	W	
12" 24" 36" 48"	60" 50CM	Custom Len.		
\$264.21 \$284.92 \$305.63 \$326.35	\$347.06 \$277.48	See Web		
Low Loss Test Flexible Cable Assemblies				
PE-P142LL Coax, 50 Ohm				
Part No. <b>PE346</b>	Cable Dia.	Attn. @ 1 GHz	Power @ 1 GHz	83
1 piece price shown. See web or call for volume pricing.	0.195" dia.	7 dB/100ft	W	
12" 24" 36" 48"	60" 50CM	Custom Len.		
\$239.33 \$255.56 \$271.80 \$288.04	\$304.27 \$249.73	See Web		
Standard Flexible Cable Assemblies				
RG142B/U Coax, 50 Ohm				
Part No. <b>PE33867</b>	Cable Dia.	Attn. @ 1 GHz	Power @ 1 GHz	84
1 piece price shown. See web or call for volume pricing.	0.195" dia.	13 dB/100ft	650 W	
12" 24" 36" 48"	60"	Custom Len.		
\$62.75 \$68.82 \$74.90 \$81.33	\$87.53	See Web		
PE-P141EAM Coax, 50 Ohm				
Part No. <b>PE3CA1044</b>	Cable Dia.	Attn. @ 1 GHz	Power @ 1 GHz	85
1 piece price shown. See web or call for volume pricing.	0.163" dia.	dB/100ft	W	
12" 24" 36"	-	Custom Len.		
\$372.53 \$348.93 \$365.24	-	See Web		
TNC MALE TO TNC FEMALE				
Precision Formable Cable Assemblies				
PE-SR405FLJ Coax, 50 Ohm				
Part No. <b>PE39488</b>	Cable Dia.	Attn. @ 1 GHz	Power @ 1 GHz	86
1 piece price shown. See web or call for volume pricing.	0.098" dia.	20 dB/100ft	130 W	
6" 9" 12" 18"	24"	Custom Len.		
\$46.05 \$46.47 \$46.47 \$50.35	\$54.23	See Web		
Standard Formable Cable Assemblies				
PE-SR402FLJ Coax, 50 Ohm				

Part No. <b>PE39496</b>	Cable Dia.	Attn. @ 1 GHz	Power @ 1 GHz	87
1 piece price shown. See web or call for volume pricing.	0.161" dia.	12 dB/100ft	303 W	
6" 9" 12" 18"	24"	Custom Len.		
\$46.28 \$46.28 \$46.28 \$53.21	\$53.83	See Web		
TNC MALE TO TNC FEMALE BULKHEAD				
SEE MOUNTING HOLE SECTION ON PAGE 369				
Low Loss Flexible Cable Assemblies				
LMR-195 Coax, 50 Ohm				
Part No. <b>PE3W00780</b>	Cable Dia.	Attn. @ 1 GHz	Power @ 1 GHz	88
1 piece price shown. See web or call for volume pricing.	0.195" dia.	12 dB/100ft	W	
12" 24" 36" 48"	60" 50CM	Custom Len.		
\$38.47 \$38.55 \$38.62 \$38.70	\$38.78 \$38.52	See Web		
PE-P142LL-27478 Coax, 50 Ohm				
Part No. <b>PE3M0160</b>	Cable Dia.	Attn. @ 1 GHz	Power @ 1 GHz	89
1 piece price shown. See web or call for volume pricing.	0.195" dia.	dB/100ft	W	
12" 18" 24" 36"	48" 60"	Custom Len.		
\$465.61 \$474.09 \$482.56 \$499.52	\$516.48 \$533.43	See Web		
PE-P160LL-27478 Coax, 50 Ohm				
Part No. <b>PE3M0205</b>	Cable Dia.	Attn. @ 1 GHz	Power @ 1 GHz	90
1 piece price shown. See web or call for volume pricing.	0.160" dia.	dB/100ft	W	
8" 12" 18" 24"	36" 36"	Custom Len.		
\$447.80 \$452.69 \$460.05 \$467.39	\$474.75 \$482.10	See Web		
PE-P160LL Coax, 50 Ohm				
Part No. <b>PE3C5253</b>	Cable Dia.	Attn. @ 1 GHz	Power @ 1 GHz	91
1 piece price shown. See web or call for volume pricing.	0.160" dia.	dB/100ft	W	
12" 24" 36" 48"	60" 50CM	Custom Len.		
\$231.73 \$252.45 \$273.15 \$293.87	\$314.58 \$245.00	See Web		
Standard Flexible Cable Assemblies				
PE-P141EAM Coax, 50 Ohm				
Part No. <b>PE3CA1046</b>	Cable Dia.	Attn. @ 1 GHz	Power @ 1 GHz	92
1 piece price shown. See web or call for volume pricing.	0.163" dia.	dB/100ft	W	
12" 24" 36"	-	Custom Len.		
\$360.90 \$338.55 \$354.86	-	See Web		
TNC MALE TO REVERSE POLARITY TNC MALE				
Low Loss Flexible Cable Assemblies				
PE-C195 Coax, 50 Ohm				
Part No. <b>PE37137</b>	Cable Dia.	Attn. @ 1 GHz	Power @ 1 GHz	93
1 piece price shown. See web or call for volume pricing.	0.195" dia.	11 dB/100ft	150 W	
12" 24" 36" 48"	60"	Custom Len.		
\$33.51 \$34.17 \$34.84 \$39.24	\$36.16	See Web		
Standard Flexible Cable Assemblies				
RG58C/U Coax, 50 Ohm				
Part No. <b>PE35228</b>	Cable Dia.	Attn. @ 1 GHz	Power @ 1 GHz	94
1 piece price shown. See web or call for volume pricing.	0.195" dia.	20 dB/100ft	44 W	
12" 24" 36" 48"	60" 72"	Custom Len.		
\$40.23 \$38.68 \$39.45 \$40.18	\$40.90 \$44.38	See Web		
RG142B/U Coax, 50 Ohm				
Part No. <b>PE35230</b>	Cable Dia.	Attn. @ 1 GHz	Power @ 1 GHz	95
1 piece price shown. See web or call for volume pricing.	0.195" dia.	13 dB/100ft	650 W	
12" 24" 36" 48"	60" 50CM	Custom Len.		
\$45.58 \$51.32 \$57.05 \$62.78	\$68.50 \$74.24	See Web		
RG214/U Coax, 50 Ohm				
Part No. <b>PE35234</b>	Cable Dia.	Attn. @ 1 GHz	Power @ 1 GHz	96
1 piece price shown. See web or call for volume pricing.	0.425" dia.	7 dB/100ft	190 W	
12" 24" 36" 48"	60" 72"	Custom Len.		
\$81.82 \$89.22 \$105.56 \$103.97	\$111.35 \$118.74	See Web		
RG223/U Coax, 50 Ohm				
Part No. <b>PE35236</b>	Cable Dia.	Attn. @ 1 GHz	Power @ 1 GHz	97
1 piece price shown. See web or call for volume pricing.	0.210" dia.	13 dB/100ft	53 W	
12" 24" 36" 48"	60" 72"	Custom Len.		
\$42.77 \$43.30 \$46.18 \$49.12	\$51.99 \$58.64	See Web		
REVERSE POLARITY TNC MALE TO BNC MALE				
Standard Flexible Cable Assemblies				
RG58C/U Coax, 50 Ohm				
Part No. <b>PE35229</b>	Cable Dia.	Attn. @ 1 GHz	Power @ 1 GHz	98
1 piece price shown. See web or call for volume pricing.	0.195" dia.	20 dB/100ft	44 W	
12" 24" 36" 48"	60" 72"	Custom Len.		
\$41.15 \$41.89 \$42.63 \$43.37	\$44.11 \$44.83	See Web		
RG142B/U Coax, 50 Ohm				
Part No. <b>PE35231</b>	Cable Dia.	Attn. @ 1 GHz	Power @ 1 GHz	99
1 piece price shown. See web or call for volume pricing.	0.195" dia.	13 dB/100ft	650 W	
12" 24" 36" 48"	60" 72"	Custom Len.		
\$40.23 \$45.95 \$51.68 \$57.42	\$63.14 \$68.89	See Web		

\*Coax Performance at 1 GHz Notes: Cable assembly max frequency may be lower than connector or coax max frequency

For our complete selection of cable assemblies, please visit our website

Cable Assemblies

See Our Website For Current Pricing & Real-Time Stock Availability!

TNC MALE RIGHT ANGLE TO N MALE						
Low Loss Flexible Cable Assemblies						
PE-P142LL Coax, 50 Ohm						
Part No. <b>PE3C1041</b>	Cable Dia.	Attn. @ 1 GHz	Power @ 1 GHz			
1 piece price shown. See web or call for volume pricing.	0.195" dia.	10 dB/100ft	W			
12" 24" 36" 48"	60"	50CM	Custom Len.			
\$215.21 \$244.36 \$246.73 \$262.49	\$278.24	\$225.32	See Web			
PE-P142LL-27478 Coax, 50 Ohm						
Part No. <b>PE3M0171</b>	Cable Dia.	Attn. @ 1 GHz	Power @ 1 GHz			
1 piece price shown. See web or call for volume pricing.	0.195" dia.	dB/100ft	W			
12" 18" 24" 36" 48"	60"	50CM	Custom Len.			
\$485.09 \$493.57 \$502.04 \$519.00	\$535.96	\$552.91	See Web			
PE-P160LL-27478 Coax, 50 Ohm						
Part No. <b>PE3M0216</b>	Cable Dia.	Attn. @ 1 GHz	Power @ 1 GHz			
1 piece price shown. See web or call for volume pricing.	0.160" dia.	dB/100ft	W			
8" 12" 18" 24"	30" 36"	50CM	Custom Len.			
\$438.69 \$443.59 \$450.94 \$458.29	\$465.64	\$472.99	See Web			
PE-P300LL-27478 Coax, 50 Ohm						
Part No. <b>PE3M0244</b>	Cable Dia.	Attn. @ 1 GHz	Power @ 1 GHz			
1 piece price shown. See web or call for volume pricing.	0.300" dia.	dB/100ft	W			
12" 18" 24" 36"	48" 60"	50CM	Custom Len.			
\$558.37 \$572.52 \$586.67 \$614.97	\$643.28	\$671.58	See Web			
TNC MALE RIGHT ANGLE TO N MALE RIGHT ANGLE						
Low Loss Flexible Cable Assemblies						
PE-P142LL-27478 Coax, 50 Ohm						
Part No. <b>PE3M0173</b>	Cable Dia.	Attn. @ 1 GHz	Power @ 1 GHz			
1 piece price shown. See web or call for volume pricing.	0.195" dia.	dB/100ft	W			
12" 18" 24" 36"	48" 60"	50CM	Custom Len.			
\$600.12 \$608.59 \$617.07 \$634.03	\$650.99	\$667.94	See Web			
PE-P160LL-27478 Coax, 50 Ohm						
Part No. <b>PE3M0218</b>	Cable Dia.	Attn. @ 1 GHz	Power @ 1 GHz			
1 piece price shown. See web or call for volume pricing.	0.160" dia.	dB/100ft	W			
8" 12" 18" 24"	30" 36"	50CM	Custom Len.			
\$536.74 \$541.64 \$549.00 \$556.34	\$563.70	\$571.04	See Web			
PE-P300LL-27478 Coax, 50 Ohm						
Part No. <b>PE3M0246</b>	Cable Dia.	Attn. @ 1 GHz	Power @ 1 GHz			
1 piece price shown. See web or call for volume pricing.	0.300" dia.	dB/100ft	W			
12" 18" 24" 36"	48" 60"	50CM	Custom Len.			
\$703.31 \$717.46 \$731.61 \$759.91	\$788.22	\$816.52	See Web			
TNC MALE RIGHT ANGLE TO N FEMALE BULKHEAD						
SEE MOUNTING HOLE SECTION ON PAGE 369						
Low Loss Flexible Cable Assemblies						
PE-P142LL-27478 Coax, 50 Ohm						
Part No. <b>PE3M0172</b>	Cable Dia.	Attn. @ 1 GHz	Power @ 1 GHz			
1 piece price shown. See web or call for volume pricing.	0.195" dia.	dB/100ft	W			
12" 18" 24" 36"	48" 60"	50CM	Custom Len.			
\$572.29 \$580.77 \$589.25 \$606.20	\$623.16	\$640.12	See Web			
PE-P160LL-27478 Coax, 50 Ohm						
Part No. <b>PE3M0217</b>	Cable Dia.	Attn. @ 1 GHz	Power @ 1 GHz			
1 piece price shown. See web or call for volume pricing.	0.160" dia.	dB/100ft	W			
8" 12" 18" 24"	30" 36"	50CM	Custom Len.			
\$540.67 \$545.58 \$552.92 \$560.28	\$567.63	\$574.98	See Web			
PE-P300LL-27478 Coax, 50 Ohm						
Part No. <b>PE3M0245</b>	Cable Dia.	Attn. @ 1 GHz	Power @ 1 GHz			
1 piece price shown. See web or call for volume pricing.	0.300" dia.	dB/100ft	W			
12" 18" 24" 36"	48" 60"	50CM	Custom Len.			
\$634.04 \$648.19 \$662.34 \$690.64	\$718.95	\$747.25	See Web			
TNC MALE RIGHT ANGLE TO TNC MALE						
Standard Semi-Rigid Cable Assemblies						
PE-SR402AL Coax, 50 Ohm						
Part No. <b>PE3W07649</b>	Cable Dia.	Attn. @ 1 GHz	Power @ 1 GHz			
1 piece price shown. See web or call for volume pricing.	" dia.	dB/100ft	450 W			
12" 24" 36" 48"	60"	50CM	Custom Len.			
\$68.68 \$78.56 \$88.44 \$98.32	\$108.20	\$75.01	See Web			
TNC MALE RIGHT ANGLE TO TNC MALE RIGHT ANGLE						
Precision Formable Cable Assemblies						
PE-SR402FLJ Coax, 50 Ohm						

Part No. <b>PE39494</b>	Cable Dia.	Attn. @ 1 GHz	Power @ 1 GHz			
1 piece price shown. See web or call for volume pricing.	0.161" dia.	12dB/100ft	450 W			
6" 9" 12" 18" 24"	-	-	Custom Len.			
\$51.62 \$51.62 \$51.62 \$55.39 \$59.17	-	-	See Web			
PE-SR405FLJ Coax, 50 Ohm						
Part No. <b>PE39486</b>	Cable Dia.	Attn. @ 1 GHz	Power @ 1 GHz			
1 piece price shown. See web or call for volume pricing.	0.098" dia.	20 dB/100ft	130 W			
6" 9" 12" 18" 24"	-	-	Custom Len.			
\$64.57 \$33.60 \$25.63 \$52.66 \$56.38	-	-	See Web			
Low Loss Flexible Cable Assemblies						
PE-P142LL Coax, 50 Ohm						
Part No. <b>PE3C1144</b>	Cable Dia.	Attn. @ 1 GHz	Power @ 1 GHz			
1 piece price shown. See web or call for volume pricing.	0.195" dia.	7 dB/100ft	W			
12" 24" 36" 48"	60"	50CM	Custom Len.			
\$325.84 \$342.08 \$358.30 \$374.54	\$390.78	\$336.24	See Web			
PE-P142LL-27478 Coax, 50 Ohm						
Part No. <b>PE3M0170</b>	Cable Dia.	Attn. @ 1 GHz	Power @ 1 GHz			
1 piece price shown. See web or call for volume pricing.	0.195" dia.	dB/100ft	W			
12" 18" 24" 36"	48" 60"	50CM	Custom Len.			
\$600.12 \$608.64 \$617.07 \$634.03	\$650.99	\$667.94	See Web			
PE-P160LL-27478 Coax, 50 Ohm						
Part No. <b>PE3M0215</b>	Cable Dia.	Attn. @ 1 GHz	Power @ 1 GHz			
1 piece price shown. See web or call for volume pricing.	0.160" dia.	dB/100ft	W			
8" 12" 18" 24"	30" 36"	50CM	Custom Len.			
\$536.74 \$541.64 \$549.00 \$556.34	\$563.70	\$571.04	See Web			
PE-P300LL-27478 Coax, 50 Ohm						
Part No. <b>PE3M0243</b>	Cable Dia.	Attn. @ 1 GHz	Power @ 1 GHz			
1 piece price shown. See web or call for volume pricing.	0.300" dia.	dB/100ft	W			
12" 18" 24" 36"	48" 60"	50CM	Custom Len.			
\$698.67 \$712.82 \$726.97 \$755.27	\$783.57	\$811.87	See Web			
PE-P160LL Coax, 50 Ohm						
Part No. <b>PE3C5250</b>	Cable Dia.	Attn. @ 1 GHz	Power @ 1 GHz			
1 piece price shown. See web or call for volume pricing.	0.160" dia.	dB/100ft	W			
12" 24" 36" 48"	60"	50CM	Custom Len.			
\$322.97 \$343.69 \$364.40 \$385.11	\$405.82	\$336.24	See Web			
Standard Flexible Cable Assemblies						
RG142B/U Coax, 50 Ohm						
Part No. <b>PE3194</b>	Cable Dia.	Attn. @ 1 GHz	Power @ 1 GHz			
1 piece price shown. See web or call for volume pricing.	0.195" dia.	13dB/100ft	W			
12" 24" 36" 48"	-	-	Custom Len.			
\$79.16 \$85.24 \$86.15 \$91.89	-	-	See Web			
RG400/U Coax, 50 Ohm						
Part No. <b>PE3W00037</b>	Cable Dia.	Attn. @ 1 GHz	Power @ 1 GHz			
1 piece price shown. See web or call for volume pricing.	0.195" dia.	15 dB/100ft	650 W			
12" 24" 36" 48"	60"	50CM	Custom Len.			
\$93.47 \$101.07 \$108.69 \$116.31	\$123.92	\$98.34	See Web			
TNC MALE RIGHT ANGLE TO TNC FEMALE						
Low Loss Flexible Cable Assemblies						
LMR-240 Coax, 50 Ohm						
Part No. <b>PE3W06709</b>	Cable Dia.	Attn. @ 1 GHz	Power @ 1 GHz			
1 piece price shown. See web or call for volume pricing.	0.240" dia.	8 dB/100ft	W			
12" 18" 24" 36"	48" 60"	50CM	Custom Len.			
\$53.30 \$53.72 \$54.15 \$55.00	\$55.85	\$56.70	See Web			
TNC MALE RIGHT ANGLE TO TNC FEMALE BULKHEAD						
SEE MOUNTING HOLE SECTION ON PAGE 369						
Low Loss Flexible Cable Assemblies						
PE-P160LL Coax, 50 Ohm						
Part No. <b>PE3C5254</b>	Cable Dia.	Attn. @ 1 GHz	Power @ 1 GHz			
1 piece price shown. See web or call for volume pricing.	0.160" dia.	dB/100ft	W			
12" 24" 36" 48"	60"	50CM	Custom Len.			
\$290.49 \$306.55 \$326.94 \$347.35	\$367.74	\$299.20	See Web			
TNC FEMALE TO SMA MALE						
Standard Flexible Cable Assemblies						
RG55B/U Coax, 53 Ohm						
Part No. <b>PE3W07646</b>	Cable Dia.	Attn. @ 1 GHz	Power @ 1 GHz			
1 piece price shown. See web or call for volume pricing.	0.202" dia.	dB/100ft	53 W			
12" 24" 36" 48"	60"	50CM	Custom Len.			
\$41.92 \$44.70 \$47.47 \$50.25	\$53.02	\$43.70	See Web			
TNC FEMALE TO TNC MALE						
Standard Formable Cable Assemblies						

Continued on Next Page

For Custom Lengths, Metric Lengths or Special Configurations, Please call (949) 261-1920



Technical Support  
+1 (949) 261-1920



Same-Day Shipping,  
Even Custom Cable Assemblies

For our complete selection of cable assemblies, please visit our website

Cable Assemblies

See Our Website For Current Pricing & Real-Time Stock Availability!

PE-SR402FL Coax, 50 Ohm				
Part No. <a href="#">PE39482</a>	Cable Dia.	Attn. @ 1 GHz	Power @ 1 GHz	
1 piece price shown. See web or call for volume pricing.				
6"	9"	12"	18"	24"
\$46.47	\$46.47	\$46.47	\$56.74	\$57.34

REVERSE POLARITY TNC FEMALE TO REVERSE POLARITY SMA MALE				

**Standard Flexible Cable Assemblies**

RG55B/U Coax, 53 Ohm				
Part No. <a href="#">PE3W07647</a>	Cable Dia.	Attn. @ 1 GHz	Power @ 1 GHz	
1 piece price shown. See web or call for volume pricing.				
12"	24"	36"	48"	60"
\$47.27	\$50.05	\$52.82	\$55.60	\$58.37

TNC FEMALE BULKHEAD TO MCX PLUG RIGHT ANGLE				
SEE MOUNTING HOLE SECTION ON PAGE 369				

**Precision Formable Cable Assemblies**

PE-SR405FL Coax, 50 Ohm				
Part No. <a href="#">PE39477</a>	Cable Dia.	Attn. @ 1 GHz	Power @ 1 GHz	
1 piece price shown. See web or call for volume pricing.				
6"	9"	12"	18"	24"
\$17.52	\$20.17	\$22.83	\$66.90	\$51.77

PE-SR405FLJ Coax, 50 Ohm				
Part No. <a href="#">PE39491</a>	Cable Dia.	Attn. @ 1 GHz	Power @ 1 GHz	
1 piece price shown. See web or call for volume pricing.				
6"	9"	12"	18"	24"
\$41.39	\$42.71	\$44.70	\$45.12	\$48.85

**Standard Flexible Cable Assemblies**

RG174A/U Coax, 50 Ohm				
Part No. <a href="#">PE33799</a>	Cable Dia.	Attn. @ 1 GHz	Power @ 1 GHz	
1 piece price shown. See web or call for volume pricing.				
12"	24"	36"	48"	60"
\$65.58	\$61.16	\$61.58	\$62.02	\$62.46

TNC FEMALE BULKHEAD TO MMCX PLUG RIGHT ANGLE				
SEE MOUNTING HOLE SECTION ON PAGE 369				

**Precision Formable Cable Assemblies**

PE-SR405FL Coax, 50 Ohm				
Part No. <a href="#">PE39478</a>	Cable Dia.	Attn. @ 1 GHz	Power @ 1 GHz	
1 piece price shown. See web or call for volume pricing.				
6"	9"	12"	18"	24"
\$44.84	\$46.62	\$50.35	\$51.97	\$57.32

**Standard Formable Cable Assemblies**

PE-SR405FLJ Coax, 50 Ohm				
Part No. <a href="#">PE39492</a>	Cable Dia.	Attn. @ 1 GHz	Power @ 1 GHz	
1 piece price shown. See web or call for volume pricing.				
6"	9"	12"	18"	24"
\$42.87	\$44.95	\$47.01	\$51.29	\$55.56

**Standard Flexible Cable Assemblies**

RG188A/U Coax, 50 Ohm				
Part No. <a href="#">PE35635</a>	Cable Dia.	Attn. @ 1 GHz	Power @ 1 GHz	
1 piece price shown. See web or call for volume pricing.				
12"	24"	36"	48"	60"
\$72.14	\$74.63	\$77.12	\$73.45	\$75.67

RG316/U Coax, 50 Ohm				
Part No. <a href="#">PE3W04293</a>	Cable Dia.	Attn. @ 1 GHz	Power @ 1 GHz	
1 piece price shown. See web or call for volume pricing.				
12"	24"	36"	48"	60"
\$84.23	\$87.50	\$90.79	\$94.07	\$97.35

TNC FEMALE BULKHEAD TO N MALE				
SEE MOUNTING HOLE SECTION ON PAGE 369				

**Low Loss Flexible Cable Assemblies**

PE-P142LL-27478 Coax, 50 Ohm				
Part No. <a href="#">PE3M0167</a>	Cable Dia.	Attn. @ 1 GHz	Power @ 1 GHz	
1 piece price shown. See web or call for volume pricing.				
12"	18"	24"	36"	48"
\$457.25	\$465.73	\$474.21	\$491.17	\$508.12

PE-P160LL-27478 Coax, 50 Ohm				
Part No. <a href="#">PE3M0212</a>	Cable Dia.	Attn. @ 1 GHz	Power @ 1 GHz	
1 piece price shown. See web or call for volume pricing.				
8"	12"	18"	24"	30"
\$434.75	\$439.65	\$447.00	\$454.35	\$461.70

TNC FEMALE BULKHEAD TO N MALE RIGHT ANGLE				
SEE MOUNTING HOLE SECTION ON PAGE 369				

**Low Loss Flexible Cable Assemblies**

PE-P142LL-27478 Coax, 50 Ohm				
Part No. <a href="#">PE3M0169</a>	Cable Dia.	Attn. @ 1 GHz	Power @ 1 GHz	
1 piece price shown. See web or call for volume pricing.				
12"	18"	24"	36"	48"
\$572.29	\$580.77	\$589.25	\$606.20	\$623.16

PE-P160LL-27478 Coax, 50 Ohm				
Part No. <a href="#">PE3M0214</a>	Cable Dia.	Attn. @ 1 GHz	Power @ 1 GHz	
1 piece price shown. See web or call for volume pricing.				
8"	12"	18"	24"	30"
\$532.81	\$537.70	\$545.06	\$552.41	\$559.76

TNC FEMALE BULKHEAD TO N FEMALE BULKHEAD				
SEE MOUNTING HOLE SECTION ON PAGE 369				

**Low Loss Flexible Cable Assemblies**

PE-P142LL-27478 Coax, 50 Ohm				
Part No. <a href="#">PE3M0168</a>	Cable Dia.	Attn. @ 1 GHz	Power @ 1 GHz	
1 piece price shown. See web or call for volume pricing.				
12"	18"	24"	36"	48"
\$544.46	\$552.94	\$561.41	\$578.37	\$595.33

PE-P160LL-27478 Coax, 50 Ohm				
Part No. <a href="#">PE3M0213</a>	Cable Dia.	Attn. @ 1 GHz	Power @ 1 GHz	
1 piece price shown. See web or call for volume pricing.				
8"	12"	18"	24"	30"
\$536.74	\$541.64	\$549.00	\$556.34	\$563.70

TNC FEMALE BULKHEAD TO SMA MALE RIGHT ANGLE				
SEE MOUNTING HOLE SECTION ON PAGE 369				

**Standard Formable Cable Assemblies**

PE-SR405FLJ Coax, 50 Ohm				
Part No. <a href="#">PE3W03175</a>	Cable Dia.	Attn. @ 1 GHz	Power @ 1 GHz	
1 piece price shown. See web or call for volume pricing.				
12"	18"	24"	36"	48"
\$68.50	\$72.81	\$77.12	\$85.74	\$94.36

**Standard Flexible Cable Assemblies**

RG174A/U Coax, 50 Ohm				
Part No. <a href="#">PE3W03417</a>	Cable Dia.	Attn. @ 1 GHz	Power @ 1 GHz	
1 piece price shown. See web or call for volume pricing.				
12"	24"	36"	48"	60"
\$65.08	\$65.64	\$66.21	\$66.77	\$67.33

RG178B/U Coax, 50 Ohm				
Part No. <a href="#">PE3W05425</a>	Cable Dia.	Attn. @ 1 GHz	Power @ 1 GHz	
1 piece price shown. See web or call for volume pricing.				
12"	24"	36"	48"	60"
\$69.73	\$70.85	\$71.98	\$73.11	\$74.25

TNC FEMALE BULKHEAD TO SMC PLUG RIGHT ANGLE				
SEE MOUNTING HOLE SECTION ON PAGE 369				

**Standard Flexible Cable Assemblies**

RG174A/U Coax, 50 Ohm				
Part No. <a href="#">PE36779</a>	Cable Dia.	Attn. @ 1 GHz	Power @ 1 GHz	
1 piece price shown. See web or call for volume pricing.				
12"	24"	36"	48"	60"
\$76.32	\$69.81	\$70.25	\$70.69	\$71.12

TNC FEMALE BULKHEAD TO SMP FEMALE RIGHT ANGLE				
SEE MOUNTING HOLE SECTION ON PAGE 369				

**Standard Formable Cable Assemblies**

PE-SR405FL Coax, 50 Ohm				
Part No. <a href="#">PE3W05541</a>	Cable Dia.	Attn. @ 1 GHz	Power @ 1 GHz	
1 piece price shown. See web or call for volume pricing.				
12"	24"	36"	48"	60"
\$113.57	\$125.25	\$136.93	\$148.61	\$160.29

TNC FEMALE BULKHEAD TO SSMC PLUG RIGHT ANGLE				
SEE MOUNTING HOLE SECTION ON PAGE 369				

**Standard Flexible Cable Assemblies**

RG188A/U Coax, 50 Ohm				
Part No. <a href="#">PE3W05752</a>	Cable Dia.	Attn. @ 1 GHz	Power @ 1 GHz	
1 piece price shown. See web or call for volume pricing.				
12"	24"	36"	48"	60"
\$103.94	\$116.23	\$118.90	\$121.57	\$124.24

\*Coax Performance at 1 GHz Notes: Cable assembly max frequency may be lower than connector or coax max frequency

For our complete selection of cable assemblies, please visit our website

**TNC FEMALE BULKHEAD TO TNC MALE**

SEE MOUNTING HOLE SECTION ON PAGE 369



**Low Loss Flexible Cable Assemblies**

PE-P142LL Coax, 50 Ohm

Part No. <b>PE348</b>	Cable Dia.	Attn. @ 1 GHz	Power @ 1 GHz
1 piece price shown. See web or call for volume pricing.	0.195" dia.	10 dB/100ft	W
12" 24" 36" 48"	60"	50CM	Custom Len.
\$198.94 \$215.17 \$231.41 \$247.65	\$263.87	\$209.35	See Web

45

**TNC FEMALE BULKHEAD TO TNC MALE RIGHT ANGLE**

SEE MOUNTING HOLE SECTION ON PAGE 369



**Low Loss Flexible Cable Assemblies**

PE-P142LL-27478 Coax, 50 Ohm

Part No. <b>PE3M0166</b>	Cable Dia.	Attn. @ 1 GHz	Power @ 1 GHz
1 piece price shown. See web or call for volume pricing.	0.195" dia.	dB/100ft	W
12" 18" 24" 36"	48" 60"	50CM	Custom Len.
\$572.29 \$580.77 \$589.25 \$606.20	\$623.16	\$640.12	See Web

46

PE-P160LL-27478 Coax, 50 Ohm

Part No. <b>PE3M0211</b>	Cable Dia.	Attn. @ 1 GHz	Power @ 1 GHz
1 piece price shown. See web or call for volume pricing.	0.160" dia.	dB/100ft	W
8" 12" 18" 24"	30" 36"	50CM	Custom Len.
\$532.81 \$537.70 \$545.06 \$552.41	\$559.76	\$567.11	See Web

47

**TNC FEMALE BULKHEAD TO TNC FEMALE BULKHEAD**

SEE MOUNTING HOLE SECTION ON PAGE 369



**Low Loss Flexible Cable Assemblies**

PE-P142LL Coax, 50 Ohm

Part No. <b>PE3C2180</b>	Cable Dia.	Attn. @ 1 GHz	Power @ 1 GHz
1 piece price shown. See web or call for volume pricing.	0.195" dia.	10 dB/100ft	W
12" 24" 36" 48"	60"	50CM	Custom Len.
\$235.24 \$251.48 \$267.72 \$283.95	\$300.19	\$245.64	See Web

48

PE-P142LL-27478 Coax, 50 Ohm

Part No. <b>PE3M0165</b>	Cable Dia.	Attn. @ 1 GHz	Power @ 1 GHz
1 piece price shown. See web or call for volume pricing.	0.195" dia.	dB/100ft	W
12" 18" 24" 36"	48" 60"	50CM	Custom Len.
\$544.46 \$552.94 \$561.41 \$578.37	\$595.33	\$612.28	See Web

49

PE-P160LL-27478 Coax, 50 Ohm

Part No. <b>PE3M0210</b>	Cable Dia.	Attn. @ 1 GHz	Power @ 1 GHz
1 piece price shown. See web or call for volume pricing.	0.160" dia.	dB/100ft	W
8" 12" 18" 24"	30" 36"	50CM	Custom Len.
\$528.87 \$533.77 \$541.12 \$548.47	\$555.82	\$563.17	See Web

50

PE-P160LL Coax, 50 Ohm

Part No. <b>PE3C5251</b>	Cable Dia.	Attn. @ 1 GHz	Power @ 1 GHz
1 piece price shown. See web or call for volume pricing.	0.160" dia.	dB/100ft	W
12" 24" 36" 48"	60"	50CM	Custom Len.
\$258.01 \$278.73 \$299.44 \$320.15	\$340.86	\$271.28	See Web

51

**TNC FEMALE BULKHEAD TO UMCX PLUG RIGHT ANGLE**

SEE MOUNTING HOLE SECTION ON PAGE 369



**Standard Flexible Cable Assemblies**

RG178B/U Coax, 50 Ohm

Part No. <b>PE38304</b>	Cable Dia.	Attn. @ 1 GHz	Power @ 1 GHz
1 piece price shown. See web or call for volume pricing.	0.072" dia.	44 dB/100ft	78 W
3" 6" 9" 12"	18" 24"	50CM	Custom Len.
\$53.28 \$54.99 \$56.71 \$58.42	\$58.81	\$62.48	See Web

52

**REVERSE POLARITY TNC FEMALE BULKHEAD TO MMCX PLUG**

SEE MOUNTING HOLE SECTION ON PAGE 369



**Low Loss Flexible Cable Assemblies**

LMR-100A-PVC Coax, 50 Ohm

Part No. <b>PE3W01379</b>	Cable Dia.	Attn. @ 1 GHz	Power @ 1 GHz
1 piece price shown. See web or call for volume pricing.	0.110" dia.	dB/100ft	W
12" 24" 36" 48"	60"	50CM	Custom Len.
\$78.66 \$79.39 \$80.13 \$80.87	\$81.60	\$79.13	See Web

53

**REVERSE POLARITY TNC FEMALE BULKHEAD TO SMC PLUG RIGHT ANGLE**

SEE MOUNTING HOLE SECTION ON PAGE 369



**Standard Flexible Cable Assemblies**

RG188A/U Coax, 50 Ohm

Part No. <b>PE3W05762</b>	Cable Dia.	Attn. @ 1 GHz	Power @ 1 GHz
1 piece price shown. See web or call for volume pricing.	0.110" dia.	26 dB/100ft	160 W
12" 24" 36" 48"	60"	50CM	Custom Len.
\$93.76 \$96.42 \$99.09 \$101.76	\$104.43	\$95.46	See Web

54

**REVERSE POLARITY TNC FEMALE BULKHEAD TO REVERSE POLARITY TNC**

SEE MOUNTING HOLE SECTION ON PAGE 369



**Standard Formable Cable Assemblies**

PE-SR402FLJ Coax, 50 Ohm

Part No. <b>PE3W05610</b>	Cable Dia.	Attn. @ 1 GHz	Power @ 1 GHz
1 piece price shown. See web or call for volume pricing.	0.161" dia.	12 dB/100ft	303 W
12" 24" 36" 48"	60"	50CM	Custom Len.
\$82.39 \$91.28 \$100.16 \$109.04	\$117.93	\$88.08	See Web

55

**REVERSE POLARITY TNC FEMALE BULKHEAD TO UMCX PLUG**

SEE MOUNTING HOLE SECTION ON PAGE 369



**Standard Flexible Cable Assemblies**

RG178B/U Coax, 50 Ohm

Part No. <b>PE38303</b>	Cable Dia.	Attn. @ 1 GHz	Power @ 1 GHz
1 piece price shown. See web or call for volume pricing.	0.072" dia.	dB/100ft	W
3" 6" 9" 12"	18" 24"	50CM	Custom Len.
\$53.56 \$53.56 \$53.56 \$55.70	\$57.24	\$60.92	See Web

56

**UHF MALE TO BNC MALE**



**Low Loss Flexible Cable Assemblies**

PE-C195 Coax, 50 Ohm

Part No. <b>PE38674</b>	Cable Dia.	Attn. @ 1 GHz	Power @ 1 GHz
1 piece price shown. See web or call for volume pricing.	0.195" dia.	11 dB/100ft	150 W
12" 24" 36" 48"	60"	-	Custom Len.
\$26.16 \$26.88 \$27.60 \$30.12	\$29.49	-	See Web

57

**Standard Flexible Cable Assemblies**

RG8A/U Coax, 50 Ohm

Part No. <b>PE34581</b>	Cable Dia.	Attn. @ 1 GHz	Power @ 1 GHz
1 piece price shown. See web or call for volume pricing.	0.405" dia.	8 dB/100ft	190 W
12" 24" 36" 48"	60" 72"	50CM	Custom Len.
\$63.83 \$66.58 \$73.80 \$72.03	\$74.74	\$77.50	See Web

58

RG58C/U Coax, 50 Ohm

Part No. <b>PE3057</b>	Cable Dia.	Attn. @ 1 GHz	Power @ 1 GHz
1 piece price shown. See web or call for volume pricing.	0.195" dia.	20 dB/100ft	44 W
12" 24" 36" 48"	60" 72"	50CM	Custom Len.
\$36.43 \$37.24 \$38.05 \$38.91	\$39.74	\$40.57	See Web

59

RG142B/U Coax, 50 Ohm

Part No. <b>PE3898</b>	Cable Dia.	Attn. @ 1 GHz	Power @ 1 GHz
1 piece price shown. See web or call for volume pricing.	0.195" dia.	13 dB/100ft	650 W
12" 24" 36" 48"	60" 72"	50CM	Custom Len.
\$35.42 \$41.14 \$46.88 \$52.61	\$58.34	\$64.08	See Web

60

RG213/U Coax, 50 Ohm

Part No. <b>PE34583</b>	Cable Dia.	Attn. @ 1 GHz	Power @ 1 GHz
1 piece price shown. See web or call for volume pricing.	0.405" dia.	8 dB/100ft	190 W
12" 24" 36" 48"	60" 72"	50CM	Custom Len.
\$66.50 \$68.17 \$69.82 \$71.49	\$73.15	\$74.82	See Web

61

RG214/U Coax, 50 Ohm

Part No. <b>PE33438</b>	Cable Dia.	Attn. @ 1 GHz	Power @ 1 GHz
1 piece price shown. See web or call for volume pricing.	0.425" dia.	7 dB/100ft	190 W
12" 24" 36" 48"	60" 72"	50CM	Custom Len.
\$65.98 \$73.36 \$80.74 \$93.73	\$95.52	\$102.88	See Web

62

RG223/U Coax, 50 Ohm

Part No. <b>PE3803</b>	Cable Dia.	Attn. @ 1 GHz	Power @ 1 GHz
1 piece price shown. See web or call for volume pricing.	0.210" dia.	13 dB/100ft	53 W
12" 24" 36" 48"	60" 72"	50CM	Custom Len.
\$32.63 \$35.53 \$38.43 \$41.33	\$44.23	\$47.13	See Web

63

RG225/U Coax, 50 Ohm

Part No. <b>PE34589</b>	Cable Dia.	Attn. @ 1 GHz	Power @ 1 GHz
1 piece price shown. See web or call for volume pricing.	0.430" dia.	dB/100ft	1700 W
12" 24" 36" 48"	60" 72"	50CM	Custom Len.
\$96.27 \$121.74 \$154.32 \$186.91	\$219.49	\$252.07	See Web

64

RG400/U Coax, 50 Ohm

Part No. <b>PE3231</b>	Cable Dia.	Attn. @ 1 GHz	Power @ 1 GHz
1 piece price shown. See web or call for volume pricing.	0.195" dia.	15 dB/100ft	600 W
12" 24" 36" 48"	60" 72"	50CM	Custom Len.
\$43.51 \$53.52 \$60.92 \$64.42	\$71.39	\$78.36	See Web

65

RG55B/U Coax, 53 Ohm

Part No. <b>PE34591</b>	Cable Dia.	Attn. @ 1 GHz	Power @ 1 GHz
1 piece price shown. See web or call for volume pricing.	0.202" dia.	17 dB/100ft	53 W
12" 24" 36" 48"	60" 72"	50CM	Custom Len.
\$31.78 \$34.02 \$36.26 \$38.51	\$40.75	\$42.98	See Web

66

RG59B/U Coax, 75 Ohm

Part No. <b>PE3543</b>	Cable Dia.	Attn. @ 1 GHz	Power @ 1 GHz
1 piece price shown. See web or call for volume pricing.	0.242" dia.	12 dB/100ft	77 W
12" 24" 36" 48"	60" 72"	50CM	Custom Len.
\$28.71 \$29.61 \$30.51 \$31.40	\$32.32	\$33.21	See Web

67

Cable Assemblies

See Our Website For Current Pricing & Real-Time Stock Availability!

For Custom Lengths, Metric Lengths or Special Configurations, Please call (949) 261-1920



Technical Support  
+1 (949) 261-1920



Same-Day Shipping,  
Even Custom Cable Assemblies

For our complete selection of cable assemblies, please visit our website

Cable Assemblies  
See Our Website For Current Pricing & Real-Time Stock Availability!

RG62A/U Coax, 93 Ohm						
Part No. <a href="#">PE34587</a>	Cable Dia.	Attn. @ 1 GHz	Power @ 1 GHz			
1 piece price shown. See web or call for volume pricing.						
12"	24"	36"	48"	60"	72"	Custom Len.
\$31.46	\$32.82	\$34.19	\$38.06	\$36.94	\$38.31	See Web
<b>UHF MALE TO UHF MALE</b>						
<b>Low Loss Flexible Cable Assemblies</b>						
PE-C195 Coax, 50 Ohm						
Part No. <a href="#">PE38632</a>	Cable Dia.	Attn. @ 1 GHz	Power @ 1 GHz			
1 piece price shown. See web or call for volume pricing.						
12"	24"	36"	48"	60"	-	Custom Len.
\$25.23	\$25.89	\$26.72	\$28.04	\$29.42	-	See Web
<b>Standard Flexible Cable Assemblies</b>						
RG8A/U Coax, 50 Ohm						
Part No. <a href="#">PE3623</a>	Cable Dia.	Attn. @ 1 GHz	Power @ 1 GHz			
1 piece price shown. See web or call for volume pricing.						
12"	24"	36"	48"	60"	72"	Custom Len.
\$64.15	\$62.23	\$65.06	\$67.90	\$70.72	\$73.56	See Web
<b>RG58C/U Coax, 50 Ohm</b>						
Part No. <a href="#">PE3015</a>	Cable Dia.	Attn. @ 1 GHz	Power @ 1 GHz			
1 piece price shown. See web or call for volume pricing.						
12"	24"	36"	48"	60"	72"	Custom Len.
\$37.11	\$37.93	\$38.74	\$39.61	\$40.44	\$41.26	See Web
<b>RG142B/U Coax, 50 Ohm</b>						
Part No. <a href="#">PE33053</a>	Cable Dia.	Attn. @ 1 GHz	Power @ 1 GHz			
1 piece price shown. See web or call for volume pricing.						
12"	24"	36"	48"	60"	-	Custom Len.
\$37.12	\$43.20	\$49.28	\$52.22	\$57.96	-	See Web
<b>RG213/U Coax, 50 Ohm</b>						
Part No. <a href="#">PE3635</a>	Cable Dia.	Attn. @ 1 GHz	Power @ 1 GHz			
1 piece price shown. See web or call for volume pricing.						
12"	24"	36"	48"	60"	72"	Custom Len.
\$57.24	\$58.89	\$60.55	\$62.22	\$63.88	\$65.54	See Web
<b>RG214/U Coax, 50 Ohm</b>						
Part No. <a href="#">PE3796</a>	Cable Dia.	Attn. @ 1 GHz	Power @ 1 GHz			
1 piece price shown. See web or call for volume pricing.						
12"	24"	48"	60"	72"	-	Custom Len.
\$68.31	\$70.58	\$85.23	\$92.56	\$107.97	-	See Web
<b>RG223/U Coax, 50 Ohm</b>						
Part No. <a href="#">PE3845</a>	Cable Dia.	Attn. @ 1 GHz	Power @ 1 GHz			
1 piece price shown. See web or call for volume pricing.						
12"	24"	36"	48"	60"	72"	Custom Len.
\$31.53	\$34.43	\$37.33	\$40.24	\$43.13	\$46.03	See Web
<b>RG393/U Coax, 50 Ohm</b>						
Part No. <a href="#">PE33267</a>	Cable Dia.	Attn. @ 1 GHz	Power @ 1 GHz			
1 piece price shown. See web or call for volume pricing.						
12"	24"	36"	48"	60"	72"	Custom Len.
\$71.72	\$83.13	\$104.53	\$114.06	\$129.53	\$144.99	See Web
<b>RG400/U Coax, 50 Ohm</b>						
Part No. <a href="#">PE3743</a>	Cable Dia.	Attn. @ 1 GHz	Power @ 1 GHz			
1 piece price shown. See web or call for volume pricing.						
12"	24"	36"	48"	60"	-	Custom Len.
\$41.63	\$48.60	\$55.58	\$62.54	\$69.51	-	See Web
<b>RG59B/U Coax, 75 Ohm</b>						
Part No. <a href="#">PE3580</a>	Cable Dia.	Attn. @ 1 GHz	Power @ 1 GHz			
1 piece price shown. See web or call for volume pricing.						
12"	24"	36"	48"	60"	72"	Custom Len.
\$28.12	\$29.01	\$29.91	\$33.54	\$31.70	\$32.62	See Web
<b>HMCX32 1.2 PLUG TO HMCX32 1.2 PLUG</b>						
<b>Standard Flexible Cable Assemblies</b>						
PE-81mm Coax, 50 Ohm						
Part No. <a href="#">PE3CA1058</a>	Cable Dia.	Attn. @ 1 GHz	Power @ 1 GHz			
1 piece price shown. See web or call for volume pricing.						
6"	9"	12"	-	-	-	Custom Len.
\$10.04	\$10.80	\$11.57	-	-	-	See Web
<b>UMCX PLUG RIGHT ANGLE TO MCX PLUG</b>						
<b>Standard Flexible Cable Assemblies</b>						
RG178B/U Coax, 50 Ohm						
Part No. <a href="#">PE38890</a>	Cable Dia.	Attn. @ 1 GHz	Power @ 1 GHz			
1 piece price shown. See web or call for volume pricing.						
3"	6"	9"	12"	18"	24"	Custom Len.
\$62.00	\$63.52	\$62.00	\$66.95	\$65.66	\$69.35	See Web

<b>UMCX PLUG RIGHT ANGLE TO MCX PLUG RIGHT ANGLE</b>						
<b>Standard Flexible Cable Assemblies</b>						
RG178B/U Coax, 50 Ohm						
Part No. <a href="#">PE38502</a>	Cable Dia.	Attn. @ 1 GHz	Power @ 1 GHz			
1 piece price shown. See web or call for volume pricing.						
3"	6"	9"	12"	18"	24"	Custom Len.
\$57.29	\$58.44	\$57.29	\$57.29	\$60.97	\$64.65	See Web
<b>UMCX PLUG RIGHT ANGLE TO MCX JACK BULKHEAD</b>						
SEE MOUNTING HOLE SECTION ON PAGE 369						
<b>Standard Flexible Cable Assemblies</b>						
RG178B/U Coax, 50 Ohm						
Part No. <a href="#">PE38889</a>	Cable Dia.	Attn. @ 1 GHz	Power @ 1 GHz			
1 piece price shown. See web or call for volume pricing.						
3"	6"	9"	12"	18"	24"	Custom Len.
\$72.93	\$72.93	\$72.93	\$78.77	\$76.62	\$80.29	See Web
<b>PE-113mm Coax, 50 Ohm</b>						
Part No. <a href="#">PE38298</a>	Cable Dia.	Attn. @ 1 GHz	Power @ 1 GHz			
1 piece price shown. See web or call for volume pricing.						
6"	12"	-	-	-	-	Custom Len.
\$23.38	\$22.77	-	-	-	-	See Web
<b>UMCX PLUG RIGHT ANGLE TO MMCX PLUG RIGHT ANGLE</b>						
<b>Standard Flexible Cable Assemblies</b>						
RG178B/U Coax, 50 Ohm						
Part No. <a href="#">PE39078</a>	Cable Dia.	Attn. @ 1 GHz	Power @ 1 GHz			
1 piece price shown. See web or call for volume pricing.						
3"	6"	9"	12"	18"	24"	Custom Len.
\$62.85	\$64.56	\$66.28	\$67.99	\$71.52	\$75.06	See Web
<b>UMCX 2.1 PLUG TO UMCX 2.1 PLUG</b>						
<b>Standard Flexible Cable Assemblies</b>						
PE-81mm Coax, 50 Ohm						
Part No. <a href="#">PE3CA1056</a>	Cable Dia.	Attn. @ 1 GHz	Power @ 1 GHz			
1 piece price shown. See web or call for volume pricing.						
6"	9"	12"	-	-	-	Custom Len.
\$7.97	\$9.70	\$10.47	-	-	-	See Web
<b>UMCX 2.5 PLUG TO UMCX 2.5 PLUG</b>						
<b>Standard Flexible Cable Assemblies</b>						
RG178B/U Coax, 50 Ohm						
Part No. <a href="#">PE3CA1054</a>	Cable Dia.	Attn. @ 1 GHz	Power @ 1 GHz			
1 piece price shown. See web or call for volume pricing.						
6"	9"	12"	-	-	-	Custom Len.
\$10.25	\$11.70	\$12.88	-	-	-	See Web
<b>RG178-DS Coax, 50 Ohm</b>						
Part No. <a href="#">PE3CA1055</a>	Cable Dia.	Attn. @ 1 GHz	Power @ 1 GHz			
1 piece price shown. See web or call for volume pricing.						
6"	9"	12"	-	-	-	Custom Len.
\$10.71	\$12.88	\$16.57	-	-	-	See Web
<b>PE-113mm Coax, 50 Ohm</b>						
Part No. <a href="#">PE3CA1052</a>	Cable Dia.	Attn. @ 1 GHz	Power @ 1 GHz			
1 piece price shown. See web or call for volume pricing.						
6"	9"	12"	-	-	-	Custom Len.
\$8.78	\$8.67	\$10.47	-	-	-	See Web
<b>PE-137mm Coax, 50 Ohm</b>						
Part No. <a href="#">PE3CA1053</a>	Cable Dia.	Attn. @ 1 GHz	Power @ 1 GHz			
1 piece price shown. See web or call for volume pricing.						
6"	9"	12"	-	-	-	Custom Len.
\$9.16	\$10.04	\$10.92	-	-	-	See Web
<b>WMCX 1.6 PLUG TO WMCX 1.6 PLUG</b>						
<b>Standard Flexible Cable Assemblies</b>						
PE-81mm Coax, 50 Ohm						
Part No. <a href="#">PE3CA1057</a>	Cable Dia.	Attn. @ 1 GHz	Power @ 1 GHz			
1 piece price shown. See web or call for volume pricing.						
6"	9"	12"	-	-	-	Custom Len.
\$8.47	\$9.15	\$11.04	-	-	-	See Web

\*Coax Performance at 1 GHz Notes: Cable assembly max frequency may be lower than connector or coax max frequency

For our complete selection of cable assemblies, please visit our website

**2.92MM NMD FEMALE TO 2.92MM MALE**



**Standard Flexible Cable Assemblies**

PE-VNA-R Coax, 50 Ohm

Part No. <a href="#">PE3VNA4007</a>	Cable Dia.	Attn. @ 1 GHz	Power @ 1 GHz
1 piece price shown. See web or call for volume pricing.			
24"	0.430" dia.	dB/100ft	W
36"	-	-	-
48"	-	-	-
60"	-	-	-
180"	-	-	-
Custom Len.	-	-	-
\$2,266.15	\$2,373.30	\$2,477.20	-
-	-	-	See Web

91

**2.92MM NMD FEMALE TO 2.92MM FEMALE**



**Standard Flexible Cable Assemblies**

PE-VNA-R Coax, 50 Ohm

Part No. <a href="#">PE3VNA4008</a>	Cable Dia.	Attn. @ 1 GHz	Power @ 1 GHz
1 piece price shown. See web or call for volume pricing.			
24"	0.430" dia.	dB/100ft	W
36"	-	-	-
48"	-	-	-
60"	-	-	-
180"	-	-	-
Custom Len.	-	-	-
\$2,331.09	\$2,438.24	\$2,538.89	-
-	-	-	See Web

92

**MCX PLUG TO 75 OHM BNC MALE**



**Standard Flexible Cable Assemblies**

RG187A/U Coax, 75 Ohm

Part No. <a href="#">PE3C5491</a>	Cable Dia.	Attn. @ 1 GHz	Power @ 1 GHz
1 piece price shown. See web or call for volume pricing.			
12"	0.102" dia.	25 dB/100ft	200 W
24"	-	-	-
36"	-	-	-
48"	-	-	-
60"	-	-	-
180"	-	-	-
Custom Len.	-	-	-
\$44.20	\$47.91	\$51.62	\$55.33
-	-	-	\$59.04
-	-	-	\$46.58
-	-	-	See Web

93

**BNC MALE TO NMO MOUNT SEXLESS**



**Standard Flexible Cable Assemblies**

RG58C/U Coax, 50 Ohm

Part No. <a href="#">PE37844</a>	Cable Dia.	Attn. @ 1 GHz	Power @ 1 GHz
1 piece price shown. See web or call for volume pricing.			
60"	0.195" dia.	20 dB/100ft	44 W
120"	-	-	-
180"	-	-	-
Custom Len.	-	-	-
\$42.45	\$50.14	\$49.81	-
-	-	-	See Web

94

**BNC MALE TO CUT LEAD SEXLESS**



**Standard Flexible Cable Assemblies**

RG188A/U Coax, 50 Ohm

Part No. <a href="#">PE3C3583</a>	Cable Dia.	Attn. @ 1 GHz	Power @ 1 GHz
1 piece price shown. See web or call for volume pricing.			
12"	0.110" dia.	26 dB/100ft	160 W
24"	-	-	-
36"	-	-	-
48"	-	-	-
60"	-	-	-
180"	-	-	-
Custom Len.	-	-	-
\$23.15	\$25.57	\$27.99	\$30.41
-	-	-	\$32.83
-	-	-	Call
-	-	-	See Web

95

**BNC FEMALE TO NMO MOUNT SEXLESS**



**Standard Flexible Cable Assemblies**

RG58C/U Coax, 50 Ohm

Part No. <a href="#">PE37845</a>	Cable Dia.	Attn. @ 1 GHz	Power @ 1 GHz
1 piece price shown. See web or call for volume pricing.			
60"	0.195" dia.	20 dB/100ft	44 W
120"	-	-	-
180"	-	-	-
Custom Len.	-	-	-
\$41.37	\$45.04	\$48.69	-
-	-	-	See Web

96

**MINI UHF MALE TO NMO MOUNT SEXLESS**



**Standard Flexible Cable Assemblies**

RG58C/U Coax, 50 Ohm

Part No. <a href="#">PE37846</a>	Cable Dia.	Attn. @ 1 GHz	Power @ 1 GHz
1 piece price shown. See web or call for volume pricing.			
60"	0.195" dia.	20 dB/100ft	44 W
120"	-	-	-
180"	-	-	-
Custom Len.	-	-	-
\$41.30	\$44.98	\$48.66	-
-	-	-	See Web

97

**N MALE TO NMO MOUNT SEXLESS**



**Standard Flexible Cable Assemblies**

RG58C/U Coax, 50 Ohm

Part No. <a href="#">PE37850</a>	Cable Dia.	Attn. @ 1 GHz	Power @ 1 GHz
1 piece price shown. See web or call for volume pricing.			
60"	0.195" dia.	20 dB/100ft	44 W
120"	-	-	-
180"	-	-	-
Custom Len.	-	-	-
\$52.39	\$56.53	\$60.68	-
-	-	-	See Web

98

**N FEMALE TO NMO MOUNT SEXLESS**



**Standard Flexible Cable Assemblies**

RG58C/U Coax, 50 Ohm

Part No. <a href="#">PE37851</a>	Cable Dia.	Attn. @ 1 GHz	Power @ 1 GHz
1 piece price shown. See web or call for volume pricing.			
60"	0.195" dia.	20 dB/100ft	44 W
120"	-	-	-
180"	-	-	-
Custom Len.	-	-	-
\$47.98	\$51.63	\$60.26	-
-	-	-	See Web

99

**SMA MALE TO NMO MOUNT SEXLESS**



**Standard Flexible Cable Assemblies**

RG58C/U Coax, 50 Ohm

Part No. <a href="#">PE37840</a>	Cable Dia.	Attn. @ 1 GHz	Power @ 1 GHz
1 piece price shown. See web or call for volume pricing.			
60"	0.195" dia.	20 dB/100ft	44 W
120"	-	-	-
180"	-	-	-
Custom Len.	-	-	-
\$51.10	\$50.87	\$59.39	-
-	-	-	See Web

1

**SMA FEMALE TO NMO MOUNT SEXLESS**



**Standard Flexible Cable Assemblies**

RG58C/U Coax, 50 Ohm

Part No. <a href="#">PE37841</a>	Cable Dia.	Attn. @ 1 GHz	Power @ 1 GHz
1 piece price shown. See web or call for volume pricing.			
60"	0.195" dia.	20 dB/100ft	44 W
120"	-	-	-
180"	-	-	-
Custom Len.	-	-	-
\$60.05	\$59.16	\$62.84	-
-	-	-	See Web

2

**SMA FEMALE TO TRIMMED LEAD SEXLESS**



**Standard Semi-Rigid Cable Assemblies**

PE-020SR Coax, 50 Ohm

Part No. <a href="#">PE3CA1104</a>	Cable Dia.	Attn. @ 1 GHz	Power @ 1 GHz
1 piece price shown. See web or call for volume pricing.			
3"	0.020" dia.	dB/100ft	W
6"	-	-	-
9"	-	-	-
12"	-	-	-
Custom Len.	-	-	-
\$95.25	\$112.74	\$130.25	\$147.75
-	-	-	See Web

3

PE-034SR Coax, 50 Ohm

Part No. <a href="#">PE3CA1105</a>	Cable Dia.	Attn. @ 1 GHz	Power @ 1 GHz
1 piece price shown. See web or call for volume pricing.			
3"	0.034" dia.	dB/100ft	W
6"	-	-	-
9"	-	-	-
12"	-	-	-
Custom Len.	-	-	-
\$35.59	\$42.13	\$48.68	\$55.22
-	-	-	Call
-	-	-	See Web

4

PE-SR047TN Coax, 50 Ohm

Part No. <a href="#">PE3CA1106</a>	Cable Dia.	Attn. @ 1 GHz	Power @ 1 GHz
1 piece price shown. See web or call for volume pricing.			
3"	0.047" dia.	dB/100ft	W
6"	-	-	-
9"	-	-	-
12"	-	-	-
Custom Len.	-	-	-
\$38.17	\$41.95	\$47.20	\$52.43
-	-	-	See Web

5

**SMA FEMALE TO CUT LEAD SEXLESS**



**Standard Semi-Rigid Cable Assemblies**

PE-020SR Coax, 50 Ohm

Part No. <a href="#">PE3CA1107</a>	Cable Dia.	Attn. @ 1 GHz	Power @ 1 GHz
1 piece price shown. See web or call for volume pricing.			
3"	0.020" dia.	dB/100ft	W
6"	-	-	-
9"	-	-	-
12"	-	-	-
Custom Len.	-	-	-
\$61.56	\$80.37	\$99.17	\$117.98
-	-	-	See Web

6

PE-034SR Coax, 50 Ohm

Part No. <a href="#">PE3CA1102</a>	Cable Dia.	Attn. @ 1 GHz	Power @ 1 GHz
1 piece price shown. See web or call for volume pricing.			
3"	0.034" dia.	dB/100ft	W
6"	-	-	-
9"	-	-	-
12"	-	-	-
Custom Len.	-	-	-
\$31.34	\$36.59	\$41.87	\$47.17
-	-	-	See Web

7

PE-047SR Coax, 50 Ohm

Part No. <a href="#">PE3CA1103</a>	Cable Dia.	Attn. @ 1 GHz	Power @ 1 GHz
1 piece price shown. See web or call for volume pricing.			
3"	0.047" dia.	dB/100ft	W
6"	-	-	-
9"	-	-	-
12"	-	-	-
Custom Len.	-	-	-
\$31.15	\$36.42	\$41.68	\$46.99
-	-	-	See Web

8

**TNC FEMALE TO NMO MOUNT SEXLESS**



**Standard Flexible Cable Assemblies**

RG58C/U Coax, 50 Ohm

Part No. <a href="#">PE37849</a>	Cable Dia.	Attn. @ 1 GHz	Power @ 1 GHz
1 piece price shown. See web or call for volume pricing.			
60"	0.195" dia.	20 dB/100ft	44 W
120"	-	-	-
180"	-	-	-
Custom Len.	-	-	-
\$49.73	\$53.41	\$57.09	-
-	-	-	See Web

9

For Custom Lengths, Metric Lengths or Special Configurations, Please call (949) 261-1920



Technical Support  
+1 (949) 261-1920



Same-Day Shipping,  
Even Custom Cable Assemblies

Cable Assemblies

See Our Website For Current Pricing & Real-Time Stock Availability!





For our complete selection of cable assemblies, please visit our website

Part No. <a href="#">PE33448</a>		Cable Dia.	Attn. @ 1 GHz	Power @ 1 GHz	34		
1 piece price shown. See web or call for volume pricing.		0.332" dia.	11 dB/100ft	125 W			
12"	24"	36"	48"	60"		72"	Custom Len.
\$101.39	\$103.24	\$105.05	\$106.90	\$108.70		\$110.57	See Web
<b>RG59B/U Coax, 75 Ohm</b>							
Part No. <a href="#">PE33452</a>		Cable Dia.	Attn. @ 1 GHz	Power @ 1 GHz	35		
1 piece price shown. See web or call for volume pricing.		0.242" dia.	12 dB/100ft	77 W			
12"	24"	36"	48"	60"		72"	Custom Len.
\$48.82	\$49.71	\$50.62	\$51.51	\$52.42		\$53.31	See Web
<b>RG179B/U Coax, 75 Ohm</b>							
Part No. <a href="#">PE33451</a>		Cable Dia.	Attn. @ 1 GHz	Power @ 1 GHz	36		
1 piece price shown. See web or call for volume pricing.		0.100" dia.	25 dB/100ft	200 W			
12"	24"	36"	48"	60"		72"	Custom Len.
\$53.69	\$56.07	\$58.47	\$60.81	\$63.22		\$69.95	See Web
<b>RG187A/U Coax, 75 Ohm</b>							
Part No. <a href="#">PE33456</a>		Cable Dia.	Attn. @ 1 GHz	Power @ 1 GHz	37		
1 piece price shown. See web or call for volume pricing.		0.110" dia.	25 dB/100ft	200 W			
12"	24"	36"	48"	60"		72"	Custom Len.
\$54.64	\$57.87	\$61.19	\$64.48	\$67.77		\$71.08	See Web
<b>75 OHM BNC FEMALE BULKHEAD TO 75 OHM BNC FEMALE BULKHEAD</b>							
SEE MOUNTING HOLE SECTION ON PAGE 369							
<b>Flexible Cable Assemblies</b>							
<b>RG187A/U Coax, 75 Ohm</b>							
Part No. <a href="#">PE3W07034</a>		Cable Dia.	Attn. @ 1 GHz	Power @ 1 GHz	38		
1 piece price shown. See web or call for volume pricing.		0.102" dia.	25 dB/100ft	200 W			
12"	24"	36"	48"	60"		50CM	Custom Len.
\$66.81	\$70.97	\$73.00	\$77.21	\$81.37		\$67.39	See Web
<b>Standard Flexible Cable Assemblies</b>							
<b>RG62A/U Coax, 93 Ohm</b>							
Part No. <a href="#">PE3W06444</a>		Cable Dia.	Attn. @ 1 GHz	Power @ 1 GHz	39		
1 piece price shown. See web or call for volume pricing.		0.239" dia.	9 dB/100ft	77 W			
12"	24"	36"	48"	60"		50CM	Custom Len.
\$67.33	\$69.63	\$71.95	\$74.27	\$76.58		\$68.80	See Web
<b>75 OHM F MALE TO 75 OHM BNC MALE</b>							
<b>Standard Flexible Cable Assemblies</b>							
<b>RG6-CATV Coax, 75 Ohm</b>							
Part No. <a href="#">PE36145</a>		Cable Dia.	Attn. @ 1 GHz	Power @ 1 GHz	40		
1 piece price shown. See web or call for volume pricing.		0.275" dia.	7 dB/100ft	7 W			
12"	24"	36"	48"	60"		72"	Custom Len.
\$32.81	\$34.01	\$33.03	\$36.48	\$37.69		\$36.14	See Web
<b>RG11A/U Coax, 75 Ohm</b>							
Part No. <a href="#">PE36147</a>		Cable Dia.	Attn. @ 1 GHz	Power @ 1 GHz	41		
1 piece price shown. See web or call for volume pricing.		0.405" dia.	dB/100ft	150 W			
12"	24"	36"	48"	60"		72"	Custom Len.
\$53.30	\$55.03	\$56.74	\$58.45	\$60.18		\$61.89	See Web
<b>RG59B/U Coax, 75 Ohm</b>							
Part No. <a href="#">PE36149</a>		Cable Dia.	Attn. @ 1 GHz	Power @ 1 GHz	42		
1 piece price shown. See web or call for volume pricing.		0.242" dia.	12 dB/100ft	77 W			
12"	24"	36"	48"	60"		72"	Custom Len.
\$28.84	\$27.66	\$30.91	\$32.01	\$33.07		\$31.50	See Web
<b>RG179B/U Coax, 75 Ohm</b>							
Part No. <a href="#">PE36153</a>		Cable Dia.	Attn. @ 1 GHz	Power @ 1 GHz	43		
1 piece price shown. See web or call for volume pricing.		0.100" dia.	29 dB/100ft	W			
12"	24"	36"	48"	60"		72"	Custom Len.
\$39.46	\$42.03	\$44.58	\$43.65	\$46.01		\$48.37	See Web
<b>RG187A/U Coax, 75 Ohm</b>							
Part No. <a href="#">PE36155</a>		Cable Dia.	Attn. @ 1 GHz	Power @ 1 GHz	44		
1 piece price shown. See web or call for volume pricing.		0.110" dia.	25 dB/100ft	200 W			
12"	24"	36"	48"	60"		72"	Custom Len.
\$42.53	\$42.78	\$46.18	\$49.59	\$52.99		\$56.39	See Web
<b>75 OHM F MALE TO 75 OHM F MALE</b>							
<b>Low Loss Flexible Cable Assemblies</b>							
<b>PE-SF200LL75 Coax, 75 Ohm</b>							
Part No. <a href="#">PE3TC1202</a>		Cable Dia.	Attn. @ 1 GHz	Power @ 1 GHz	45		
1 piece price shown. See web or call for volume pricing.		0.195" dia.	dB/100ft	W			
24"	36"	48"	72"	100CM		200CM	Custom Len.
\$85.89	\$97.15	\$108.41	\$130.92	\$100.32		\$137.25	See Web
<b>Standard Flexible Cable Assemblies</b>							
<b>RG6A/U Coax, 75 Ohm</b>							
Part No. <a href="#">PE37163</a>		Cable Dia.	Attn. @ 1 GHz	Power @ 1 GHz	46		
1 piece price shown. See web or call for volume pricing.		0.332" dia.	11 dB/100ft	125 W			
12"	24"	36"	48"	60"		-	Custom Len.
\$16.46	\$20.94	\$24.43	\$28.12	\$31.67		-	See Web
<b>RG6-CATV Coax, 75 Ohm</b>							

Part No. <a href="#">PE36132</a>		Cable Dia.	Attn. @ 1 GHz	Power @ 1 GHz	47		
1 piece price shown. See web or call for volume pricing.		0.275" dia.	7 dB/100ft	7 W			
12"	24"	36"	48"	60"		72"	Custom Len.
\$18.88	\$20.07	\$21.28	\$22.55	\$23.76		\$24.99	See Web
<b>RG11A/U Coax, 75 Ohm</b>							
Part No. <a href="#">PE36135</a>		Cable Dia.	Attn. @ 1 GHz	Power @ 1 GHz	48		
1 piece price shown. See web or call for volume pricing.		0.405" dia.	dB/100ft	150 W			
12"	24"	36"	48"	60"		72"	Custom Len.
\$39.63	\$41.35	\$46.13	\$44.78	\$46.51		\$48.22	See Web
<b>RG59B/U Coax, 75 Ohm</b>							
Part No. <a href="#">PE36141</a>		Cable Dia.	Attn. @ 1 GHz	Power @ 1 GHz	49		
1 piece price shown. See web or call for volume pricing.		0.242" dia.	12 dB/100ft	77 W			
12"	24"	36"	48"	60"		72"	Custom Len.
\$16.39	\$17.42	\$18.46	\$19.56	\$19.30		\$20.26	See Web
<b>RG59-WHITE Coax, 75 Ohm</b>							
Part No. <a href="#">PE36143</a>		Cable Dia.	Attn. @ 1 GHz	Power @ 1 GHz	50		
1 piece price shown. See web or call for volume pricing.		0.242" dia.	8 dB/100ft	77 W			
12"	24"	36"	48"	60"		72"	Custom Len.
\$16.23	\$18.21	\$20.18	\$22.16	\$24.15		\$26.07	See Web
<b>RG179B/U Coax, 75 Ohm</b>							
Part No. <a href="#">PE36137</a>		Cable Dia.	Attn. @ 1 GHz	Power @ 1 GHz	51		
1 piece price shown. See web or call for volume pricing.		0.100" dia.	25 dB/100ft	200 W			
12"	24"	36"	48"	60"		72"	Custom Len.
\$27.10	\$27.88	\$32.21	\$32.68	\$35.01		\$37.41	See Web
<b>RG187A/U Coax, 75 Ohm</b>							
Part No. <a href="#">PE36139</a>		Cable Dia.	Attn. @ 1 GHz	Power @ 1 GHz	52		
1 piece price shown. See web or call for volume pricing.		0.110" dia.	25 dB/100ft	200 W			
12"	24"	36"	48"	60"		72"	Custom Len.
\$27.97	\$28.62	\$31.80	\$34.90	\$38.09		\$41.26	See Web
<b>75 OHM F MALE TO 75 OHM F MALE RIGHT ANGLE</b>							
<b>Standard Flexible Cable Assemblies</b>							
<b>RG59B/U Coax, 75 Ohm</b>							
Part No. <a href="#">PE38343</a>		Cable Dia.	Attn. @ 1 GHz	Power @ 1 GHz	53		
1 piece price shown. See web or call for volume pricing.		0.242" dia.	12 dB/100ft	77 W			
12"	24"	36"	48"	60"		-	Custom Len.
\$21.15	\$24.31	\$23.07	\$24.03	\$24.98		-	See Web
<b>75 OHM F MALE TO 75 OHM F FEMALE</b>							
<b>Low Loss Flexible Cable Assemblies</b>							
<b>PE-SF200LL75 Coax, 75 Ohm</b>							
Part No. <a href="#">PE3TC1203</a>		Cable Dia.	Attn. @ 1 GHz	Power @ 1 GHz	54		
1 piece price shown. See web or call for volume pricing.		0.195" dia.	dB/100ft	W			
24"	36"	48"	72"	100CM		200CM	Custom Len.
\$85.89	\$97.15	\$108.41	\$130.92	\$100.32		\$137.25	See Web
<b>75 OHM F MALE TO 75 OHM F FEMALE BULKHEAD</b>							
SEE MOUNTING HOLE SECTION ON PAGE 369							
<b>Standard Flexible Cable Assemblies</b>							
<b>RG179B/U Coax, 75 Ohm</b>							
Part No. <a href="#">PE3C5570</a>		Cable Dia.	Attn. @ 1 GHz	Power @ 1 GHz	55		
1 piece price shown. See web or call for volume pricing.		0.100" dia.	25 dB/100ft	W			
12"	24"	36"	48"	60"		-	Custom Len.
\$26.90	\$29.27	\$31.63	\$33.99	\$36.37		-	See Web
<b>75 OHM MINI SMB PLUG TO 75 OHM BNC MALE</b>							
<b>Standard Flexible Cable Assemblies</b>							
<b>RG59B/U Coax, 75 Ohm</b>							
Part No. <a href="#">PE34701</a>		Cable Dia.	Attn. @ 1 GHz	Power @ 1 GHz	56		
1 piece price shown. See web or call for volume pricing.		0.242" dia.	12 dB/100ft	77 W			
12"	24"	36"	48"	60"		72"	Custom Len.
\$47.50	\$48.54	\$46.73	\$47.68	\$51.73		\$49.61	See Web
<b>RG179B/U Coax, 75 Ohm</b>							
Part No. <a href="#">PE34703</a>		Cable Dia.	Attn. @ 1 GHz	Power @ 1 GHz	57		
1 piece price shown. See web or call for volume pricing.		0.100" dia.	25 dB/100ft	200 W			
12"	24"	36"	48"	60"		72"	Custom Len.
\$53.50	\$56.06	\$58.62	\$61.32	\$59.94		\$62.30	See Web
<b>RG187A/U Coax, 75 Ohm</b>							
Part No. <a href="#">PE34705</a>		Cable Dia.	Attn. @ 1 GHz	Power @ 1 GHz	58		
1 piece price shown. See web or call for volume pricing.		0.110" dia.	25 dB/100ft	200 W			
12"	24"	36"	48"	60"		72"	Custom Len.
\$54.52	\$54.84	\$58.24	\$66.21	\$65.04		\$68.44	See Web

Cable Assemblies

See Our Website For Current Pricing & Real-Time Stock Availability!

For Custom Lengths, Metric Lengths or Special Configurations, Please call (949) 261-1920



Technical Support  
+1 (949) 261-1920



Same-Day Shipping,  
Even Custom Cable Assemblies



For our complete selection of cable assemblies, please visit our website

75 OHM N FEMALE TO 75 OHM N FEMALE							
<b>Standard Flexible Cable Assemblies</b>							
<b>RG11A/U Coax, 75 Ohm</b>							
Part No. <a href="#">PE3W04530</a>		Cable Dia.	Attn. @ 1 GHz	Power @ 1 GHz			
1 piece price shown. See web or call for volume pricing.		0.405" dia.	dB/100ft	150 W			
12"	24"	36"	48"	60"	72"	Custom Len.	82
\$87.05	\$89.26	\$91.47	\$93.69	\$95.90	\$88.46	See Web	
<b>75 OHM SMB PLUG TO 75 OHM BNC MALE</b>							
<b>Standard Flexible Cable Assemblies</b>							
<b>RG59B/U Coax, 75 Ohm</b>							
Part No. <a href="#">PE33270</a>		Cable Dia.	Attn. @ 1 GHz	Power @ 1 GHz			
1 piece price shown. See web or call for volume pricing.		0.242" dia.	12 dB/100ft	77 W			
12"	24"	36"	48"	60"	72"	Custom Len.	83
\$52.72	\$53.76	\$54.80	\$51.69	\$52.66	\$53.60	See Web	
<b>75 OHM SMB PLUG TO 75 OHM BNC MALE</b>							
<b>Standard Flexible Cable Assemblies</b>							
<b>RG179B/U Coax, 75 Ohm</b>							
Part No. <a href="#">PE33247</a>		Cable Dia.	Attn. @ 1 GHz	Power @ 1 GHz			
1 piece price shown. See web or call for volume pricing.		0.100" dia.	25 dB/100ft	200 W			
12"	24"	36"	48"	60"	72"	Custom Len.	84
\$57.43	\$55.54	\$62.55	\$65.25	\$67.86	\$70.46	See Web	
<b>75 OHM SMB PLUG TO 75 OHM SMB PLUG</b>							
<b>Standard Flexible Cable Assemblies</b>							
<b>RG59B/U Coax, 75 Ohm</b>							
Part No. <a href="#">PE3041</a>		Cable Dia.	Attn. @ 1 GHz	Power @ 1 GHz			
1 piece price shown. See web or call for volume pricing.		0.242" dia.	12 dB/100ft	77 W			
12"	24"	36"	48"	60"	72"	Custom Len.	86
\$59.87	\$60.82	\$61.78	\$62.75	\$63.70	\$64.66	See Web	
<b>75 OHM SMC PLUG TO 75 OHM BNC MALE</b>							
<b>Standard Flexible Cable Assemblies</b>							
<b>RG179B/U Coax, 75 Ohm</b>							
Part No. <a href="#">PE3100</a>		Cable Dia.	Attn. @ 1 GHz	Power @ 1 GHz			
1 piece price shown. See web or call for volume pricing.		0.100" dia.	29 dB/100ft	W			
12"	24"	36"	48"	60"	72"	Custom Len.	87
\$54.22	\$61.11	\$58.95	\$61.34	\$63.76	\$71.59	See Web	
<b>75 OHM SMC PLUG TO 75 OHM SMC PLUG</b>							
<b>Standard Flexible Cable Assemblies</b>							
<b>RG59B/U Coax, 75 Ohm</b>							
Part No. <a href="#">PE33330</a>		Cable Dia.	Attn. @ 1 GHz	Power @ 1 GHz			
1 piece price shown. See web or call for volume pricing.		0.242" dia.	12 dB/100ft	77 W			
12"	24"	36"	48"	60"	72"	Custom Len.	88
\$46.08	\$49.88	\$48.01	\$48.96	\$53.08	\$50.88	See Web	
<b>75 OHM SMC PLUG TO 75 OHM SMC PLUG</b>							
<b>Standard Flexible Cable Assemblies</b>							
<b>RG179B/U Coax, 75 Ohm</b>							
Part No. <a href="#">PE33586</a>		Cable Dia.	Attn. @ 1 GHz	Power @ 1 GHz			
1 piece price shown. See web or call for volume pricing.		0.100" dia.	25 dB/100ft	200 W			
12"	24"	36"	48"	60"	72"	Custom Len.	89
\$60.15	\$59.10	\$65.26	\$63.83	\$70.57	\$73.18	See Web	
<b>75 OHM SMC PLUG TO 75 OHM SMC PLUG</b>							
<b>Standard Flexible Cable Assemblies</b>							
<b>PE-B150 Coax, 75 Ohm</b>							
Part No. <a href="#">PE33646</a>		Cable Dia.	Attn. @ 1 GHz	Power @ 1 GHz			
1 piece price shown. See web or call for volume pricing.		0.150" dia.	20 dB/100ft	25 W			
12"	24"	36"	48"	60"	72"	Custom Len.	90
\$63.20	\$67.92	\$64.78	\$65.57	\$66.36	\$71.69	See Web	
<b>75 OHM SMC PLUG TO 75 OHM SMC PLUG</b>							
<b>Standard Flexible Cable Assemblies</b>							
<b>RG59B/U Coax, 75 Ohm</b>							
Part No. <a href="#">PE3362</a>		Cable Dia.	Attn. @ 1 GHz	Power @ 1 GHz			
1 piece price shown. See web or call for volume pricing.		0.242" dia.	12 dB/100ft	77 W			
12"	24"	36"	48"	60"	72"	Custom Len.	91
\$56.84	\$57.80	\$64.61	\$59.71	\$60.68	\$61.64	See Web	
<b>75 OHM SMC PLUG TO 75 OHM SMC PLUG</b>							
<b>Standard Flexible Cable Assemblies</b>							
<b>RG179B/U Coax, 75 Ohm</b>							
Part No. <a href="#">PE3376</a>		Cable Dia.	Attn. @ 1 GHz	Power @ 1 GHz			
1 piece price shown. See web or call for volume pricing.		0.100" dia.	25 dB/100ft	200 W			
12"	24"	36"	48"	60"	72"	Custom Len.	92
\$58.95	\$61.29	\$63.70	\$66.04	\$68.44	\$70.84	See Web	

PE-B150 Coax, 75 Ohm							
Part No. <a href="#">PE3388</a>		Cable Dia.	Attn. @ 1 GHz	Power @ 1 GHz			
1 piece price shown. See web or call for volume pricing.		0.150" dia.	20 dB/100ft	25 W			
12"	24"	36"	48"	60"	72"	Custom Len.	93
\$71.42	\$76.63	\$73.00	\$73.79	\$74.58	\$75.37	See Web	
<b>75 OHM TNC MALE TO 75 OHM BNC MALE</b>							
<b>Standard Flexible Cable Assemblies</b>							
<b>RG6A/U Coax, 75 Ohm</b>							
Part No. <a href="#">PE35350</a>		Cable Dia.	Attn. @ 1 GHz	Power @ 1 GHz			
1 piece price shown. See web or call for volume pricing.		0.332" dia.	11 dB/100ft	125 W			
12"	24"	36"	48"	60"	72"	Custom Len.	94
\$50.73	\$50.55	\$53.22	\$55.89	\$58.57	\$61.25	See Web	
<b>75 OHM TNC MALE TO 75 OHM TNC MALE</b>							
<b>Standard Flexible Cable Assemblies</b>							
<b>RG11A/U Coax, 75 Ohm</b>							
Part No. <a href="#">PE35354</a>		Cable Dia.	Attn. @ 1 GHz	Power @ 1 GHz			
1 piece price shown. See web or call for volume pricing.		0.405" dia.	dB/100ft	150 W			
12"	24"	36"	48"	60"	72"	Custom Len.	95
\$80.05	\$81.78	\$83.48	\$85.21	\$86.93	\$88.64	See Web	
<b>75 OHM TNC MALE TO 75 OHM TNC MALE</b>							
<b>Standard Flexible Cable Assemblies</b>							
<b>RG59B/U Coax, 75 Ohm</b>							
Part No. <a href="#">PE35358</a>		Cable Dia.	Attn. @ 1 GHz	Power @ 1 GHz			
1 piece price shown. See web or call for volume pricing.		0.242" dia.	12 dB/100ft	77 W			
12"	24"	36"	48"	60"	72"	Custom Len.	96
\$43.59	\$44.53	\$45.50	\$46.45	\$47.41	\$51.49	See Web	
<b>75 OHM TNC MALE TO 75 OHM TNC MALE</b>							
<b>Standard Flexible Cable Assemblies</b>							
<b>RG179B/U Coax, 75 Ohm</b>							
Part No. <a href="#">PE35362</a>		Cable Dia.	Attn. @ 1 GHz	Power @ 1 GHz			
1 piece price shown. See web or call for volume pricing.		0.100" dia.	25 dB/100ft	200 W			
12"	24"	36"	48"	60"	72"	Custom Len.	97
\$57.78	\$60.33	\$58.23	\$60.60	\$62.96	\$65.32	See Web	
<b>75 OHM TNC MALE TO 75 OHM TNC MALE</b>							
<b>Standard Flexible Cable Assemblies</b>							
<b>RG6A/U Coax, 75 Ohm</b>							
Part No. <a href="#">PE35348</a>		Cable Dia.	Attn. @ 1 GHz	Power @ 1 GHz			
1 piece price shown. See web or call for volume pricing.		0.332" dia.	11 dB/100ft	125 W			
12"	24"	36"	48"	60"	72"	Custom Len.	98
\$53.24	\$55.91	\$58.59	\$61.26	\$63.94	\$66.62	See Web	
<b>75 OHM TNC MALE TO 75 OHM TNC MALE</b>							
<b>Standard Flexible Cable Assemblies</b>							
<b>RG11A/U Coax, 75 Ohm</b>							
Part No. <a href="#">PE35352</a>		Cable Dia.	Attn. @ 1 GHz	Power @ 1 GHz			
1 piece price shown. See web or call for volume pricing.		0.405" dia.	dB/100ft	150 W			
12"	24"	36"	48"	60"	72"	Custom Len.	99
\$88.37	\$89.99	\$91.66	\$93.28	\$94.96	\$96.65	See Web	
<b>75 OHM TNC MALE TO 75 OHM TNC MALE</b>							
<b>Standard Flexible Cable Assemblies</b>							
<b>RG59B/U Coax, 75 Ohm</b>							
Part No. <a href="#">PE35356</a>		Cable Dia.	Attn. @ 1 GHz	Power @ 1 GHz			
1 piece price shown. See web or call for volume pricing.		0.242" dia.	12 dB/100ft	77 W			
12"	24"	36"	48"	60"	72"	Custom Len.	1
\$51.10	\$55.20	\$56.24	\$53.98	\$54.93	\$59.45	See Web	
<b>75 OHM TNC MALE TO 75 OHM TNC MALE</b>							
<b>Standard Flexible Cable Assemblies</b>							
<b>RG179B/U Coax, 75 Ohm</b>							
Part No. <a href="#">PE35360</a>		Cable Dia.	Attn. @ 1 GHz	Power @ 1 GHz			
1 piece price shown. See web or call for volume pricing.		0.100" dia.	25 dB/100ft	200 W			
12"	24"	36"	48"	60"	72"	Custom Len.	2
\$65.05	\$62.60	\$64.96	\$67.33	\$69.70	\$78.09	See Web	
<b>BNC TWINAX PLUG TO BNC TWINAX PLUG</b>							
<b>Standard Flexible Cable Assemblies</b>							
<b>RG108A/U Coax, 78 Ohm</b>							
Part No. <a href="#">PE3480</a>		Cable Dia.	Attn. @ 1 GHz	Power @ 1 GHz			
1 piece price shown. See web or call for volume pricing.		0.235" dia.	26 dB/100ft	30 W			
18"	36"	60"	90"	120"	180"	Custom Len.	3
\$75.77	\$79.51	\$84.69	\$110.09	\$97.41	\$110.11	See Web	
<b>3/4"-20 TWINAX MALE TO 3/4"-20 TWINAX MALE</b>							
<b>Standard Flexible Cable Assemblies</b>							
<b>PE-S330 Coax, 100 Ohm</b>							
Part No. <a href="#">PE3930</a>		Cable Dia.	Attn. @ 1 GHz	Power @ 1 GHz			
1 piece price shown. See web or call for volume pricing.		0.330" dia.	dB/100ft	W			
18"	36"	60"	90"	120"	180"	Custom Len.	4
\$80.29	\$84.27	\$89.58	\$96.22	\$102.85	\$116.12	See Web	

Cable Assemblies

See Our Website For Current Pricing & Real-Time Stock Availability!

For Custom Lengths, Metric Lengths or Special Configurations, Please call (949) 261-1920



Technical Support  
+1 (949) 261-1920



Same-Day Shipping,  
Even Custom Cable Assemblies

# CIRCULATORS AND ISOLATORS

## Circulators

### Dual Junction



Connector	Frequency Range (MHz.)	Maximum Power	VSWR Max.	Isolation (dB Min.)	Model No	1 Pc. Price	See Web for Volume Pricing	ROW
N	1,000 - 2,000	10 Watt	1.35:1	36	<a href="#">PE83CR1014</a>	\$1,358.22	See Web for Volume Pricing	1
	1,700 - 2,200		1.25:1	40	<a href="#">PE83CR1016</a>	\$859.74		2
	2,000 - 4,000	5 Watt	1.3:1	36	<a href="#">PE83CR1018</a>	\$863.37		3
	4,000 - 8,000			40	<a href="#">PE83CR1022</a>	\$609.75		4
7,000 - 12,400	10 Watt	1.35:1	36	<a href="#">PE83CR1013</a>	\$1,467.64	5		
1,000 - 2,000		1.25:1	40	<a href="#">PE83CR1015</a>	\$893.27	6		
1,700 - 2,200		1.3:1	36	<a href="#">PE83CR1017</a>	\$776.17	7		
2,000 - 4,000			40	<a href="#">PE83CR1019</a>	\$765.65	8		
4,000 - 8,000			40	<a href="#">PE83CR1021</a>	\$609.75	9		
7,000 - 12,400	5 Watt	1.45:1	32	<a href="#">PE83CR1023</a>	\$754.25	10		
8,000 - 18,000		1.25:1	40	<a href="#">PE83CR1024</a>	\$791.94	11		
11,000 - 18,000		1.4:1	34	<a href="#">PE83CR1025</a>	\$889.19	12		
18,000 - 26,500								13

### Single Junction



Connector	Frequency Range (MHz.)	Maximum Power	VSWR Max.	Isolation (dB Min.)	Model No	1 Pc. Price	See Web for Volume Pricing	ROW	
2.92mm	18,000 - 26,500	10 Watt	1.8:1	12	<a href="#">PE83CR1027</a>	\$980.00	See Web for Volume Pricing	14	
	22,000 - 33,000		1.7:1	13	<a href="#">PE83CR1028</a>	\$940.00		15	
	26,500 - 40,000		1.8:1	12	<a href="#">PE83CR1032</a>	\$1,062.86		16	
	32,000 - 36,000			14	<a href="#">PE83CR1029</a>	\$1,008.57		17	
N	135 - 175	150 Watt	1.3:1	20	<a href="#">PE8427</a>	\$1,518.57		18	
	330 - 403				<a href="#">PE8429</a>	\$1,353.30		19	
	380 - 460	1000 Watt	1.25:1		<a href="#">PE8423</a>	\$525.78		20	
	450 - 520	150 Watt			<a href="#">PE8431</a>	\$1,293.60		21	
	698 - 960	1000 Watt	1.3:1		<a href="#">PE8419</a>	\$432.08		22	
	1,000 - 2,000	10 Watt	1.35:1		18	<a href="#">PE8410</a>		\$970.81	23
	1,000 - 2,000	50 Watt		<a href="#">PE83CR1001</a>	\$1,154.11	24			
	1,700 - 2,200	10 Watt	1.25:1	20	<a href="#">PE8415</a>	\$445.35		25	
	1,700 - 2,200	50 Watt			<a href="#">PE83CR1003</a>	\$715.23		26	
	2,000 - 4,000	10 Watt	1.3:1	18	<a href="#">PE8411</a>	\$744.97		27	
	2,000 - 4,000	50 Watt		20	<a href="#">PE83CR1005</a>	\$689.40		28	
	2,000 - 4,000	100 Watt	1.35:1	18	<a href="#">PE83CR1031</a>	\$362.86		29	
	4,000 - 8,000	10 Watt			<a href="#">PE8412</a>	\$599.62		30	
	4,000 - 8,000	50 Watt	1.3:1	20	<a href="#">PE83CR1007</a>	\$543.71		31	
	7,000 - 12,400	10 Watt			<a href="#">PE8413</a>	\$513.76		32	
	7,000 - 12,400	50 Watt	1.25:1		<a href="#">PE83CR1009</a>	\$447.18		33	
SMA	135 - 175	150 Watt	1.3:1	20	<a href="#">PE8426</a>	\$1,548.94		34	
	330 - 403				<a href="#">PE8428</a>	\$1,406.08		35	
	380 - 460	1000 Watt	1.25:1		<a href="#">PE8422</a>	\$525.78		36	
	450 - 520	150 Watt			<a href="#">PE8430</a>	\$1,293.60		37	
	698 - 960	1000 Watt	1.3:1		18	<a href="#">PE8418</a>		\$457.10	38
	700 - 800	10 Watt	1.25:1		19	<a href="#">PE83CR001</a>		\$194.91	39
	800 - 960			18	<a href="#">PE83CR007</a>	\$248.59		40	
	1,000 - 2,000	1 Watt	1.35:1	18	<a href="#">PE8400</a>	\$763.20		41	
	1,000 - 2,000	10 Watt		17	<a href="#">PE83CR003</a>	\$385.19	42		
	1,000 - 2,000	50 Watt	1.25:1	18	<a href="#">PE83CR1000</a>	\$1,154.11	43		
	1,700 - 2,200	10 Watt			<a href="#">PE8414</a>	\$472.44	44		
	1,700 - 2,200	50 Watt	1.3:1	20	<a href="#">PE83CR1002</a>	\$687.72	45		
	1,700 - 2,400	10 Watt		17	<a href="#">PE83CR004</a>	\$191.33	46		
	2,000 - 4,000	1 Watt	1.3:1	18	<a href="#">PE8401</a>	\$508.30	47		
	2,000 - 4,000	10 Watt			<a href="#">PE83CR005</a>	\$306.59	48		
	2,000 - 4,000	50 Watt	1.3:1	20	<a href="#">PE83CR1004</a>	\$650.75	49		
	2,000 - 4,000	100 Watt	1.35:1	18	<a href="#">PE83CR1030</a>	\$391.43	50		
	2,000 - 6,000	25 Watt	1.5:1	14	<a href="#">PE8432</a>	\$882.93	51		
	3,000 - 5,000	10 Watt	1.3:1	18	<a href="#">PE83CR1033</a>	\$437.14	52		
	4,000 - 8,000		1.35:1	17	<a href="#">PE83CR006</a>	\$296.39	53		
	4,000 - 8,000		1.3:1	18	<a href="#">PE8402</a>	\$311.38	54		
	4,000 - 8,000		50 Watt	<a href="#">PE83CR1006</a>	\$523.30	55			
	4,000 - 8,000	80 Watt	1.4:1	17	<a href="#">PE83CR1034</a>	\$408.57	56		
	6,000 - 18,000	10 Watt	1.5:1	14	<a href="#">PE8433</a>	\$789.38	57		

Circulators & Isolators

See Our Website For Current Pricing & Real-Time Stock Availability!

## Circulators

### Single Junction



Connector	Frequency Range (MHz.)	Maximum Power	VSWR Max.	Isolation (dB Min.)	Model No	1 Pc. Price	See Web for Volume Pricing	ROW
SMA	7,000 - 12,400	10 Watt	1.3:1	18	<a href="#">PE83CR000</a>	\$303.06	See Web for Volume Pricing	58
	7,000 - 12,400				<a href="#">PE8403</a>	\$291.70		59
	7,000 - 12,400	50 Watt	1.25:1	20	<a href="#">PE83CR1008</a>	\$464.62		60
	8,000 - 18,000				<a href="#">PE83CR002</a>	\$311.26		61
	8,000 - 18,000	50 Watt	1.45:1	16	<a href="#">PE83CR1010</a>	\$470.92		62
	8,000 - 12,000				<a href="#">PE83CR1026</a>	\$505.71		63
	8,000 - 18,000	10 Watt	1.45:1	16	<a href="#">PE8404</a>	\$347.67		64
	11,000 - 18,000				<a href="#">PE8405</a>	\$354.03		65
	11,000 - 18,000	50 Watt	1.25:1	20	<a href="#">PE83CR1011</a>	\$453.31		66
	18,000 - 26,500				<a href="#">PE8406</a>	\$355.56		67
	18,000 - 26,500	50 Watt	1.4:1	17	<a href="#">PE83CR1012</a>	\$529.49		68

## Isolators

### Dual Junction



Connector	Frequency Range (MHz.)	Maximum Power	VSWR Max.	Isolation (dB Min.)	Model No	1 Pc. Price	See Web for Volume Pricing	ROW
N	1,000 - 2,000	10 Watt	1.35:1	36	<a href="#">PE83IR1014</a>	\$1,411.19	See Web for Volume Pricing	69
	1,700 - 2,200				<a href="#">PE83IR1016</a>	\$826.67		70
	2,000 - 4,000		1.3:1	40	<a href="#">PE83IR1018</a>	\$794.52		71
	4,000 - 8,000				<a href="#">PE83IR1020</a>	\$681.36		72
7,000 - 12,400	5 Watt	1.25:1	40	<a href="#">PE83IR1022</a>	\$586.86	73		
1,000 - 2,000				<a href="#">PE83IR1013</a>	\$1,411.19	74		
SMA	1,700 - 2,200	10 Watt	1.25:1	40	<a href="#">PE83IR1015</a>	\$858.91		75
	2,000 - 4,000				<a href="#">PE83IR1017</a>	\$810.41		76
	4,000 - 8,000		1.3:1	36	<a href="#">PE83IR1019</a>	\$750.93		77
	7,000 - 12,400	<a href="#">PE83IR1021</a>			\$634.14	78		
	8,000 - 18,000	5 Watt	1.25:1	32	<a href="#">PE83IR1023</a>	\$754.25		79
	11,000 - 18,000				<a href="#">PE83IR1024</a>	\$761.47		80
	18,000 - 26,500		1.4:1	34	<a href="#">PE83IR1025</a>	\$889.19	81	

### Single Junction



Connector	Frequency Range (MHz.)	Maximum Power	VSWR Max.	Isolation (dB Min.)	Model No	1 Pc. Price	See Web for Volume Pricing	ROW
2.4mm	35,000 - 42,500	10 Watt	1.6:1	14	<a href="#">PE83IR1038</a>	\$951.43	See Web for Volume Pricing	82
2.92mm	18,000 - 26,500	10 Watt	1.7:1	14	<a href="#">PE83IR1033</a>	\$748.57		83
	18,000 - 26,500				<a href="#">PE83IR1041</a>	\$1,622.86		84
	22,000 - 33,000		1.8:1	13	<a href="#">PE83IR1035</a>	\$748.57		85
	26,500 - 40,000	<a href="#">PE83IR1036</a>			\$748.57	86		
	26,500 - 40,000	5 Watt	1.5:1	14	<a href="#">PE83IR1037</a>	\$748.57		87
	26,500 - 40,000				<a href="#">PE8320</a>	\$1,136.04		88
27,000 - 31,000	<a href="#">PE8319</a>				\$1,003.36	89		
N	135 - 175	150 Watt	1.3:1	20	<a href="#">PE8322</a>	\$1,518.57		90
	330 - 403				<a href="#">PE8324</a>	\$1,037.96		91
	380 - 460	100 Watt	1.25:1	18	<a href="#">PE8425</a>	\$538.12		92
	450 - 520	150 Watt			<a href="#">PE8326</a>	\$999.00		93
	698 - 960	1000 Watt	1.3:1	18	<a href="#">PE8421</a>	\$467.99	94	
	1,000 - 2,000	<a href="#">PE8310</a>			\$1,124.82	95		
	1,000 - 2,000	10 Watt	1.35:1	17	<a href="#">PE83IR003</a>	\$400.48	96	
	1,000 - 2,000				<a href="#">PE83IR1001</a>	\$1,245.76	97	
	1,700 - 2,200	10 Watt	1.25:1	18	<a href="#">PE8417</a>	\$258.09	98	
	1,700 - 2,200	50 Watt			<a href="#">PE83IR1003</a>	\$743.12	99	
	2,000 - 4,000	10 Watt	1.3:1	18	<a href="#">PE8311</a>	\$702.27	1	
	2,000 - 4,000	50 Watt			<a href="#">PE83IR1005</a>	\$695.09	2	
4,000 - 8,000	10 Watt			<a href="#">PE8312</a>	\$599.61	3		

Circulators & Isolators

See Our Website For Current Pricing & Real-Time Stock Availability!



Technical Support  
+1 (949) 261-1920



Same-Day Shipping,  
Even Custom Cable Assemblies

## Isolators

### Single Junction



Connector	Frequency Range (MHz.)	Maximum Power	VSWR Max.	Isolation (dB Min.)	Model No	1 Pc. Price	See Web for Volume Pricing			ROW	
N	4,000 - 8,000	50 Watt	1.3:1	18	<a href="#">PE83JR1007</a>	\$611.97				4	
	7,000 - 12,400	10 Watt	1.25:1	20	<a href="#">PE8313</a>	\$760.82				5	
SMA	135 - 175	150 Watt	1.3:1	20	<a href="#">PE8321</a>	\$1,718.28				6	
	330 - 403				<a href="#">PE8323</a>	\$1,406.08				7	
	380 - 460	100 Watt	1.25:1	20	<a href="#">PE8424</a>	\$502.91				8	
	450 - 520	150 Watt			<a href="#">PE8325</a>	\$1,293.60				9	
	698 - 960	1000 Watt	1.3:1	18	<a href="#">PE8420</a>	\$448.93				10	
	800 - 900	100 Watt	1.25:1	20	<a href="#">PE83JR007</a>	\$227.39				11	
	1,000 - 2,000	10 Watt	1.35:1	18	<a href="#">PE8300</a>	\$699.97					12
	1,000 - 2,000				<a href="#">PE83JR002</a>	\$315.42					13
	1,000 - 2,000				<a href="#">PE83JR1032</a>	\$654.29					14
	1,000 - 2,000	50 Watt	1.35:1	18	<a href="#">PE83JR1000</a>	\$1,175.61				15	
	1,700 - 2,200	10 Watt	1.25:1		<a href="#">PE8416</a>	\$472.44				16	
	1,700 - 2,200	50 Watt		20	<a href="#">PE83JR1002</a>	\$743.12				17	
	1,700 - 2,400	10 Watt	1.35:1	18	<a href="#">PE83JR004</a>	\$220.36				18	
	2,000 - 4,000	1 Watt	1.3:1		<a href="#">PE8301</a>	\$519.47				19	
	2,000 - 4,000	10 Watt	1.4:1	20	<a href="#">PE83JR005</a>	\$306.59				20	
	2,000 - 4,000	50 Watt	1.3:1		<a href="#">PE83JR1004</a>	\$689.40				21	
	2,000 - 6,000	10 Watt	1.8:1	12	<a href="#">PE83JR1039</a>	\$442.86				22	
	2,000 - 6,000	25 Watt	1.5:1	14	<a href="#">PE8327</a>	\$810.39				23	
	2,000 - 8,000	10 Watt	1.35:1	15	<a href="#">PE8316</a>	\$1,321.46				24	
	2,000 - 10,000			13	<a href="#">PE8317</a>	\$1,321.46				25	
	3,500 - 12,800	2 Watt	1.5:1	17	<a href="#">PE8314</a>	\$1,222.46				26	
	4,000 - 8,000	1 Watt	1.3:1	18	<a href="#">PE8302</a>	\$311.67				27	
	4,000 - 8,000	10 Watt	1.35:1		<a href="#">PE83JR006</a>	\$303.69				28	
	4,000 - 8,000	30 Watt		19	<a href="#">PE83JR1040</a>	\$448.57				29	
	4,000 - 8,000	50 Watt	1.3:1	18	<a href="#">PE83JR1006</a>	\$508.13				30	
	4,000 - 18,000	10 Watt	1.5:1	15	<a href="#">PE8315</a>	\$1,255.92				31	
	6,000 - 18,000			14	<a href="#">PE8328</a>	\$986.83				32	
	6,000 - 18,000			1.6:1	10	<a href="#">PE83JR1029</a>	\$502.86				33
	6,000 - 18,000					<a href="#">PE83JR1030</a>	\$502.86				34
	6,000 - 18,000	<a href="#">PE83JR1031</a>	\$502.86					35			
	7,000 - 12,400	1 Watt	1.3:1	18	<a href="#">PE8303</a>	\$292.10				36	
	7,000 - 12,400	10 Watt			<a href="#">PE83JR000</a>	\$287.43				37	
8,000 - 12,000	1.35:1		20	<a href="#">PE83JR1026</a>	\$388.57				38		
8,000 - 12,000				<a href="#">PE83JR1027</a>	\$388.57				39		
8,000 - 18,000	1 Watt	1.45:1	16	<a href="#">PE8304</a>	\$316.75				40		
8,000 - 18,000	10 Watt	1.5:1		<a href="#">PE83JR001</a>	\$281.96				41		
8,000 - 18,000	50 Watt	1.45:1	20	<a href="#">PE83JR1010A</a>	\$470.91				42		
11,000 - 18,000	1 Watt	1.25:1		<a href="#">PE8305</a>	\$286.31				43		
11,000 - 18,000	50 Watt		<a href="#">PE83JR1011</a>	\$485.04				44			
12,000 - 18,000	10 Watt	1.35:1	20	<a href="#">PE83JR1028</a>	\$411.43				45		
17,300 - 22,000		1.25:1		<a href="#">PE8318</a>	\$533.20				46		
18,000 - 26,500	1 Watt	1.4:1	17	<a href="#">PE8306</a>	\$311.48				47		
18,000 - 26,500	10 Watt	1.7:1	14	<a href="#">PE83JR1034</a>	\$737.14				48		
18,000 - 26,500	50 Watt	1.4:1	17	<a href="#">PE83JR1012</a>	\$550.14				49		

Circulators & Isolators

See Our Website For Current Pricing & Real-Time Stock Availability!

See Web for Volume Pricing

# INDEX GUIDE TO COAXIAL CABLES

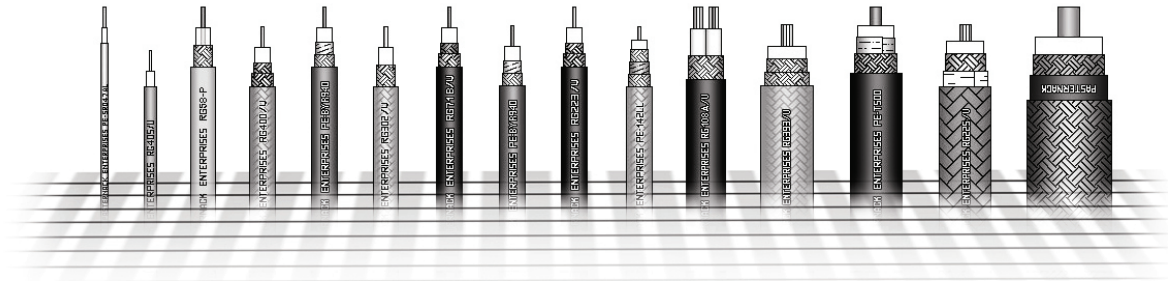

## COAXIAL CABLES.....193

### 75 OHM BROADCAST.....194

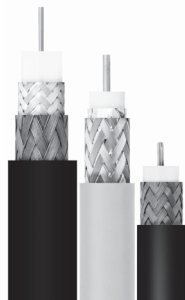

Pasternack's selection of 75 Ohm Broadcast coaxial cable includes RG59-P plenum cable, commercial grade RG6-CATV, HD mini 59 cable in multiple colors as well as PTFE jacketed RG187A/U.

### RG MIL-C-17 TYPE CABLE.....196



Pasternack offers 31 different MIL-C-17 compliant coaxial cable types. These cables are available in various diameters, jacket materials, impedances, and velocity factors, providing numerous RF cable options to fit your specific requirements.

### COMMUNICATIONS.....194

Our selection of Low Loss cable is designed with high Velocity Factor (VF) dielectric materials and two outer shields for communications applications requiring Low Loss and High Isolation. These cables are offered in several popular sizes including 0.195", 0.240", 0.400", and 0.600" diameters.



### SEMIRIGID AND FORMABLE.....197

Pasternack's Precision Cables are designed for RF and Microwave applications with frequencies up to 65 GHz. These cables are constructed of copper jacketed and tinned aluminum semirigid designs; and tinned braid conformable cable in both FEP jacketed and unjacketed designs. The semi rigid and conformable cables are available from 0.020 to 0.250 inches in diameter.

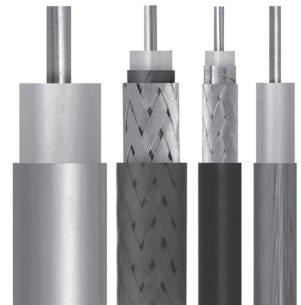

### HIGH PERFORMANCE.....195



Pasternack's line of High Performance Flexible Cable has high Velocity Factors of 70 to 85% and incorporate Spiral Wrapped outer conductors for superior shielding under flexure. These cables are used as flexible cable alternatives to semirigid cable and in many cases use the same connectors.

### TWINAX.....198



Pasternack offers two versions of Twinax cable with an impedance of 100 or 78 ohms. Twinax cable has two center conductors surrounded by a dielectric. The dielectric is surrounded by a braided outer conductor covered by a PVC jacket material. This construction creates a shielded, twisted pair with superior performance when compared to unshielded, twisted pair cable.

# COAXIAL CABLES

Meets or Exceeds MIL-C-17 Specifications Where Applicable

MODEL NO.	COAX IMPEDANCE (Ohm)	JACKET DIAMETER (in)	NUMBER OF SHIELDS	VELOCITY FACTOR (%)	MAX. POWER HANDLING AT 1 GHz (W)	JACKET MATERIAL	PRICE PER FOOT		ROW
	MAXIMUM FREQUENCY (GHz.)	CONDUCTOR DIAM.(in) [strands]	RF SHIELDING (min dB)	ATTENUATION AT 1 GHz. (dB/100 ft)	MAXIMUM OPERATING VOLTAGE (V RMS)	MINIMUM BEND RADIUS (in)	1-99 FT 500-999 FT	100-499 FT 1000 + FT	
<b>75 OHM BROADCAST</b>									
<a href="#">LMR-400-75</a>	75 2.5	0.405 0.065[1]	2 90	85		PE 1	\$1.32 \$1.32	\$1.32 \$1.32	1
<a href="#">PE-B150</a>	75 5	0.150 0.017[7]	1	20	25 600	PVC	\$1.03 \$0.93	\$0.98 \$0.89	2
<a href="#">PE-B159-BK</a>	75 3	0.159 0.023[1]	2	83 10.5	300	PVC 1.5	\$1.00 \$0.90	\$0.95 \$0.86	3
<a href="#">PE-B159-BL</a>	75 3	0.159 0.023[1]	2	83 10.5	300	PVC 1.5	\$1.05 \$0.95	\$1.00 \$0.90	4
<a href="#">PE-B159-GR</a>	75 3	0.159 0.023[1]	2	83 10.5	300	PVC 1.5	\$0.86 \$0.77	\$0.82 \$0.74	5
<a href="#">PE-B159-RD</a>	75 3	0.159 0.023[1]	2	83 10.5	300	PVC 1.5	\$0.90 \$0.81	\$0.86 \$0.77	6
<a href="#">PE-B159-WH</a>	75 3	0.159 0.023[1]	2	83 10.5	300	PVC 1.5	\$0.81 \$0.73	\$0.77 \$0.70	7
<a href="#">PE-B159-YW</a>	75 3	0.159 0.023[1]	2	83 10.5	300	PVC 1.5	\$0.85 \$0.77	\$0.81 \$0.73	8
<a href="#">PE-B305</a>	75 1	0.305 0.031[1]	2	9.2	52 2,900	PVC	\$2.58 \$2.32	\$2.45 \$2.22	9
<a href="#">RG11A/U</a>	75 1	0.405 [7]	1 45	66 8.11	150	PVC	\$2.21 \$1.99	\$2.10 \$1.90	10
<a href="#">RG179B/U</a>	75 3	0.100 0.012[7]	1	70 29.15	900	FEP	\$2.69 \$2.42	\$2.56 \$2.31	11
<a href="#">RG187A/U</a>	75 3	0.102 0.012[7]	1	70 25	200 2,000	PTFE	\$4.16 \$3.74	\$3.95 \$3.58	12
<a href="#">RG302/U</a>	75 3	0.206 0.025[7]	1	69 13	650 1,700	FEP	\$7.03 \$6.33	\$6.68 \$6.05	13
<a href="#">RG59B/U</a>	75 1	0.242 0.022[1]	1	66 11.5	77 2,300	PVC (NC)	\$1.01 \$0.91	\$0.96 \$0.87	14
<a href="#">RG6A/U</a>	75 1	0.332 0.029[1]	2 90	66 11	100	PVC (NC)	\$4.16 \$3.74	\$3.95 \$3.58	15
<a href="#">RG6-CATV</a>	75 3	0.278 0.04[1]	3 70	85 6.55	6.5	PVC (NC)	\$1.34 \$1.21	\$1.27 \$1.15	16
<b>COMMUNICATIONS</b>									
<a href="#">LMR-100A-PVC</a>	50 5.8	0.110 0.018[1]	2 90	66 24		PVC 0.25	\$0.74 \$0.74	\$0.74 \$0.74	17
<a href="#">LMR-195</a>	50 5.8	0.195 0.037[1]	2 90	80 11.8		PE 0.5	\$0.65 \$0.65	\$0.65 \$0.65	18
<a href="#">LMR-195-FR</a>	50 5.8	0.195 0.037[1]	2 90	76 11.8		FRPE 0.5	\$1.01 \$1.01	\$1.01 \$1.01	19
<a href="#">LMR-200</a>	50 5.8	0.195 0.044[1]	2 90	83 10.5		PE 0.5	\$0.72 \$0.72	\$0.72 \$0.72	20
<a href="#">LMR-200-FR</a>	50 5.8	0.195 0.044[1]	2 90	83		FRPE 0.5	\$1.02 \$1.02	\$1.02 \$1.02	21
<a href="#">LMR-200-UF</a>	50 5.8	0.195 0.044	2 90	83 12.18		TPE 0.5	\$2.15 \$2.15	\$2.15 \$2.15	22
<a href="#">LMR-240</a>	50 5.8	0.240 0.056[1]	2 90	84 8		PE 0.75	\$0.89 \$0.89	\$0.89 \$0.89	23
<a href="#">LMR-240-DB</a>	50 5.8	0.240 0.056[1]	2 90	84 7.66		PE 0.75	\$1.02 \$1.02	\$1.02 \$1.02	24
<a href="#">LMR-240-UF</a>	50 5.8	0.240 0.056	2 90	84 9.19		TPE 0.75	\$1.08 \$1.08	\$1.08 \$1.08	25
<a href="#">LMR-400</a>	50 6	0.405 0.108[1]	2 90	85 4.25		PE 1	\$1.26 \$1.26	\$1.26 \$1.26	26

Coaxial Cables

See Our Website For Current Pricing & Real-Time Stock Availability!



# COAXIAL CABLES

Meets or Exceeds MIL-C-17 Specifications Where Applicable

MODEL NO.	COAX IMPEDANCE (Ohm)	JACKET DIAMETER (in)	NUMBER OF SHIELDS	VELOCITY FACTOR (%)	MAX. POWER HANDLING AT 1 GHz (W)	JACKET MATERIAL	PRICE PER FOOT		ROW
	MAXIMUM FREQUENCY (GHz.)	CONDUCTOR DIAM.(in) [strands]	RF SHIELDING (min dB)	ATTENUATION AT 1 GHz. (dB/100 ft)	MAXIMUM OPERATING VOLTAGE (V RMS)	MINIMUM BEND RADIUS (in)	1-99 FT 500-999 FT	100-499 FT 1000 + FT	
<b>COMMUNICATIONS</b>									
<a href="#">LMR-400-DB</a>	50 6	0.405 0.108[1]	2 90	85 4.15		PE 1	\$1.34 \$1.34	\$1.34 \$1.34	27
<a href="#">LMR-400-UF</a>	50 5.8	0.405 0.108	2 90	85 5		TPE 1	\$1.82 \$1.82	\$1.82 \$1.82	28
<a href="#">LMR-500</a>	50 5.8	0.500 0.142[1]	2 90	86 3.1		PE 1.25	\$2.00 \$2.00	\$2.00 \$2.00	29
<a href="#">LMR-500-DB</a>	50 5.8	0.500 0.142[1]	2 90	86 3.1		PE 1.25	\$2.25 \$2.25	\$2.25 \$2.25	30
<a href="#">LMR-600</a>	50 5.8	0.590 0.176[1]	2 90	87 2.62		PE 1.5	\$2.27 \$2.27	\$2.27 \$2.27	31
<a href="#">LMR-600-DB</a>	50 5.8	0.590 0.176[1]	2 90	87 2.62		PE 1.5	\$2.72 \$2.72	\$2.72 \$2.72	32
<a href="#">LMR-SW396</a>	50 5.8	0.450 [1]	1 100	87 3.2		PE 2	\$1.26 \$1.26	\$1.26 \$1.26	33
<a href="#">LMR-SW540</a>	50 5.8	0.610 [1]	1 100	88 2.2		PE 3	\$1.79 \$1.79	\$1.79 \$1.79	34
<a href="#">PE-1/2FAC</a>	50 8.8	0.629 0.189[1]	1 120	88 2.2		PE 2.75	\$4.90 \$4.41	\$4.66 \$4.21	35
<a href="#">PE-1/2SFHC</a>	50 10.2	0.519 0.141[1]	1 120	82 3.41	1,000	PE 0.6	\$4.87 \$4.38	\$4.63 \$4.19	36
<a href="#">PE-1/4SFHC</a>	50 20.4	0.303 0.075[1]	1 120	82 5.85		PE 0.5	\$3.39 \$3.05	\$3.22 \$2.92	37
<a href="#">PE-B400</a>	50 4	0.403 0.103[1]	2	6	190 600	PVC	\$2.18 \$1.96	\$2.07 \$1.87	38
<a href="#">PE-C100-LSZH</a>	50 5.8	0.109 0.018[1]	2 90	66 25	40	LSZH 0.25	\$1.42 \$1.28	\$1.35 \$1.22	39
<a href="#">PE-C195</a>	50 5.8	0.195 0.037[1]	2 90	80 11.7	135	PE 0.5	\$0.82 \$0.74	\$0.78 \$0.71	40
<a href="#">PE-C200</a>	50 5.8	0.195 0.044[1]	2 90	83 10.8	170 1,000	PE	\$0.94 \$0.85	\$0.89 \$0.81	41
<a href="#">PE-C240</a>	50 5.8	0.240 0.056[1]	2 90	84 7.98	250	PE 0.75	\$1.27 \$1.14	\$1.21 \$1.09	42
<a href="#">PE-C300</a>	50 2.5	0.300 0.07[1]	2	85 6.3	350 2,000	PE 1.5	\$3.18 \$2.86	\$3.02 \$2.73	43
<a href="#">PE-C400</a>	50 5.8	0.405 0.108[1]	2 90	85 4.1	480	PE	\$1.66 \$1.49	\$1.58 \$1.43	44
<a href="#">PE-C500</a>	50 6	0.500 0.142[1]	2 90	86 3.5	720 3,000	PE	\$4.87 \$4.38	\$4.63 \$4.19	45
<a href="#">PE-C600</a>	50 5.8	0.590 0.176[1]	2 90	87 2.7	900	PE	\$2.55 \$2.30	\$2.42 \$2.19	46
<b>HIGH PERFORMANCE</b>									
<a href="#">PE-151TC</a>	50 27	0.151 0.025[1]	3 90	70 16.8	130	Polyurethane 0.75	Call Call	Call Call	47
<a href="#">PE-195TC</a>	50 27	0.195 0.037[1]	3 90	70 12.2	522	FEP 1	Call Call	Call Call	48
<a href="#">PE-P047</a>	50 20	0.056 0.011[1]	2 90	70 35	43	FEP 0.2	\$8.24 \$7.42	\$7.83 \$7.09	49
<a href="#">PE-P086</a>	50 18	0.104 0.02[1]	2 110	70 21.7		FEP	\$8.33 \$7.50	\$7.91 \$7.16	50
<a href="#">PE-P086HF</a>	50 40	0.104 0.02[1]	2	70 21.1		FEP 0.52	\$6.57 \$5.91	\$6.24 \$5.65	51
<a href="#">PE-P141</a>	50 18	0.163 0.037[1]	2 110	70 11.2	600	FEP	\$11.80 \$10.62	\$11.21 \$10.15	52

Coaxial Cables

See Our Website For Current Pricing & Real-Time Stock Availability!



Technical Support  
+1 (949) 261-1920



Same-Day Shipping,  
Even Custom Cable Assemblies

# COAXIAL CABLES

Meets or Exceeds MIL-C-17 Specifications Where Applicable

MODEL NO.	COAX IMPEDANCE (Ohm)	JACKET DIAMETER (in)	NUMBER OF SHIELDS	VELOCITY FACTOR (%)	MAX. POWER HANDLING AT 1 GHz (W)	JACKET MATERIAL	PRICE PER FOOT		ROW
	MAXIMUM FREQUENCY (GHz.)	CONDUCTOR DIAM.(in) [strands]	RF SHIELDING (min dB)	ATTENUATION AT 1 GHz. (dB/100 ft)	MAXIMUM OPERATING VOLTAGE (V RMS)	MINIMUM BEND RADIUS (in)	1-99 FT 500-999 FT	100-499 FT 1000 + FT	
<b>HIGH PERFORMANCE</b>									
<a href="#">PE-P141HF</a>	50	0.163	2	70		FEP	\$14.28	\$13.57	53
	31	0.037[1]		13			\$12.85	\$12.28	
<a href="#">PE-P195</a>	50	0.195	3	70	650	FEP	\$10.42	\$9.90	54
	22	0.037[1]		12.5	1,900		\$9.38	\$8.96	
<b>RG MIL-C-17 TYPE CABLE</b>									
<a href="#">RG141A/U</a>	50	0.190	1	70	650	PTFE (FG)	\$7.38	\$7.01	55
	10	0.037[1]		13	\$6.64		\$6.35		
<a href="#">RG142B/U</a>	50	0.195	2	70	1,900	FEP	\$5.90	\$5.61	56
	8	0.037[1]		12.9			\$5.31	\$5.07	
<a href="#">RG174A/U</a>	50	0.110	1	66	17	PVC	\$0.56	\$0.53	57
	1	0.019[7]		32	\$0.50		\$0.48		
<a href="#">RG178B/U</a>	50	0.072	1	70	55	FEP	\$1.13	\$1.07	58
	3	0.012[7]		44.41	1,000		\$1.02	\$0.97	
<a href="#">RG180B/U</a>	95	0.141	1	70	250	FEP	\$4.54	\$4.31	59
	3	0.012[7]					\$4.09	\$3.90	
<a href="#">RG188A/U</a>	50	0.110	1	26	160	PTFE	\$2.67	\$2.54	60
	3	0.02[7]					\$2.40	\$2.30	
<a href="#">RG188-DS</a>	50	0.118	2	30	160	PTFE	\$3.70	\$3.52	61
	10	0.02[7]					\$3.33	\$3.18	
<a href="#">RG196A/U</a>	50	0.080	1	49	78	PTFE	\$1.49	\$1.42	62
	1	0.011[7]					\$1.34	\$1.28	
<a href="#">RG213/U</a>	50	0.405	1	66	190	PVC	\$1.86	\$1.77	63
	1	0.09[7]		9	3,700		\$1.67	\$1.60	
<a href="#">RG214/U</a>	50	0.425	2	66	170	PVC	\$8.01	\$7.61	64
	11	0.089[7]		7.32	5,000		\$7.21	\$6.89	
<a href="#">RG217/U</a>	50	0.545	2	66	260	PVC	\$4.90	\$4.66	65
	1	0.106[1]		5.8	5,200		\$4.41	\$4.21	
<a href="#">RG218/U</a>	50	0.870	1	66	600	PVC	\$12.67	\$12.04	66
	1	0.195[1]		5	11,000		\$11.40	\$10.90	
<a href="#">RG223/U</a>	50	0.209	2	66	50	PVC	\$3.24	\$3.08	67
	12.4	0.035[1]		13.41	1,900		\$2.92	\$2.79	
<a href="#">RG225/U</a>	50	0.430	2	70	1,700	PTFE (FG)	\$37.02	\$35.17	68
	10	0.094[7]		7.5	3,700		\$33.32	\$31.84	
<a href="#">RG303/U</a>	50	0.170	1	14	650	FEP	\$6.88	\$6.54	69
	3	0.037[1]						\$6.19	
<a href="#">RG316/U</a>	50	0.102	1	69	900	FEP	\$3.28	\$3.12	70
	3	0.02[7]		38			\$2.95	\$2.82	
<a href="#">RG316-DS</a>	50	0.114	2	70	120	FEP	\$3.25	\$3.09	71
	3	0.02[7]		85	29		1,200	\$2.93	
<a href="#">RG393/U</a>	50	0.390	2	70	1,700	FEP	\$16.88	\$16.04	72
	10	0.094[7]		7.5			\$15.19	\$14.52	
<a href="#">RG400/U</a>	50	0.195	2	70	600	FEP	\$7.62	\$7.24	73
	12.4	[19]		14.7	1,900		\$6.86	\$6.55	
<a href="#">RG55B/U</a>	53	0.202	2	66	53	PE	\$2.77	\$2.63	74
	3	0.032[1]		16.5			\$2.49	\$2.38	
<a href="#">RG58C/U</a>	50	0.195	1	66	44	PVC (NC)	\$0.86	\$0.82	75
	5	0.036[19]		20	1,900		0.98	\$0.77	
<a href="#">RG58-P (1)</a>	53	0.159	1	70	143	FEP	\$6.89	\$6.55	76
	1	0.032[1]		45	17.3		\$6.20	\$5.93	
<a href="#">RG62A/U</a>	93	0.239	1	83	77	PVC	\$2.32	\$2.20	77
	1	0.025[1]		45	8.7		\$2.09	\$2.00	
<a href="#">RG8A/U</a>	50	0.405	1	66	190	PVC (NC)	\$3.28	\$3.12	78
	1	0.085[7]		8			\$2.95	\$2.82	

Coaxial Cables

See Our Website For Current Pricing & Real-Time Stock Availability!

# COAXIAL CABLES

Meets or Exceeds MIL-C-17 Specifications Where Applicable

MODEL NO.	COAX IMPEDANCE (Ohm)	JACKET DIAMETER (in)	NUMBER OF SHIELDS	VELOCITY FACTOR (%)	MAX. POWER HANDLING AT 1 GHz (W)	JACKET MATERIAL	PRICE PER FOOT		ROW
	MAXIMUM FREQUENCY (GHz.)	CONDUCTOR DIAM.(in) [strands]	RF SHIELDING (min dB)	ATTENUATION AT 1 GHz. (dB/100 ft)	MAXIMUM OPERATING VOLTAGE (V RMS)	MINIMUM BEND RADIUS (in)	1-99 FT 500-999 FT	100-499 FT 1000 + FT	
<b>RG MIL-C-17 TYPE CABLE</b>									
<a href="#">RG8X</a>	50 1	0.242 0.056[19]	1	13.5	60 2,500	PVC (NC)	\$3.95 \$3.56	\$3.75 \$3.40	79
<b>SEMIRIGID AND FORMABLE</b>									
<a href="#">PE-020SR (8)</a>	50 27	0.004[1]	1	85	2.9		\$21.12 \$19.01	\$20.06 \$18.16	80
<a href="#">PE-034SR (2,8)</a>	50 40	0.008[1]	1	60	10		\$11.94 \$10.75	\$11.34 \$10.27	81
<a href="#">PE-047SR (3,8)</a>	50 40	0.011[1]	1	40	32		\$10.74 \$9.67	\$10.20 \$9.24	82
<a href="#">PE-047SR-STRAIGHT</a>	50 40	0.047 0.011[1]	1	40		0.05	\$11.58 \$10.42	\$11.00 \$9.96	83
<a href="#">PE-118SR (2)</a>	50 46	0.032[1]	1	12.5	500 3,000	0.4	\$43.11 \$38.80	\$40.95 \$37.07	84
<a href="#">PE-SR047AL (3,6)</a>	50 20	0.011[1]	1 90	70 41	32		\$9.88 \$8.89	\$9.39 \$8.50	85
<a href="#">PE-SR047AL-STRAIGHT</a>	50 20	0.047 0.011[1]	1 90	70 41	1,000	0.05	\$10.85 \$9.77	\$10.31 \$9.33	86
<a href="#">PE-SR047FL (12)</a>	50 20	0.011[1]	1	70 36	32		\$8.68 \$7.81	\$8.25 \$7.46	87
<a href="#">PE-SR401FL (11)</a>	50 18	0.065[1]	1 100	70 6.8	279	0.75	\$16.97 \$15.27	\$16.12 \$14.59	88
<a href="#">PE-SR402-75 (3,8)</a>	75 36	0.02[1]	1	12.5	280 3,500	0.1	\$10.88 \$9.79	\$10.34 \$9.36	89
<a href="#">PE-SR402-75-STRAIGHT</a>	75 36	0.02[1]	1	12.5			\$10.85 \$9.77	\$10.31 \$9.33	90
<a href="#">PE-SR402AL (3,10)</a>	50 36	0.036[1]	1	70 13	450		\$9.88 \$8.89	\$9.39 \$8.50	91
<a href="#">PE-SR402AL-STRAIGHT</a>	50 36	0.141 0.036[1]	1	70 13		0.1	\$10.03 \$9.03	\$9.53 \$8.63	92
<a href="#">PE-SR402FL (4)</a>	50 20	0.037[1]	110	70 12	400		\$8.40 \$7.56	\$7.98 \$7.22	93
<a href="#">PE-SR402FLJ (13)</a>	50 34	0.161 0.036[1]	100	70 11.89	303.4 1,900	FEP 0.315	\$8.88 \$7.99	\$8.44 \$7.64	94
<a href="#">PE-SR402TN</a>	50 36	0.036	1	70 12		1	\$6.74 \$6.07	\$6.40 \$5.80	95
<a href="#">PE-SR402TN-STRAIGHT</a>	50 36	0.036	1	70 12		1	\$8.35 \$7.52	\$7.93 \$7.18	96
<a href="#">PE-SR405AL (3,9)</a>	50 40	0.02[1]	1	23	130	0.05	\$9.24 \$8.32	\$8.78 \$7.95	97
<a href="#">PE-SR405AL-STRAIGHT</a>	50 40	0.02[1]	1	23		0.05	\$9.24 \$8.32	\$8.78 \$7.95	98
<a href="#">PE-SR405FL (5)</a>	50 20	0.02[1]	1	70 22.5	105		\$11.68 \$10.51	\$11.10 \$10.04	99
<a href="#">PE-SR405FLJ (14)</a>	50 61	0.105 0.02[1]	1 100	70 19.5	121.5 1,500	FEP 0.5	\$8.96 \$8.06	\$8.51 \$7.71	1
<a href="#">PE-SR405TN</a>	50 40	0.02[1]	1	22		0.05	\$6.37 \$5.73	\$6.05 \$5.48	2
<a href="#">PE-SR405TN-STRAIGHT</a>	50 40	0.02[1]	1	22		0.05	\$6.98 \$6.28	\$6.63 \$6.00	3
<a href="#">PECX001</a>	50 115	0.013[1]	1	77 30	101	0.125	\$11.60 \$10.44	\$11.02 \$9.98	4
<a href="#">PECX002</a>	50 115	0.013[1]	1	77 30	101	0.125	\$15.48 \$13.93	\$14.71 \$13.31	5

Coaxial Cables

See Our Website For Current Pricing & Real-Time Stock Availability!



Technical Support  
+1 (949) 261-1920



Same-Day Shipping,  
Even Custom Cable Assemblies

# COAXIAL CABLES

Meets or Exceeds MIL-C-17 Specifications Where Applicable

MODEL NO.	COAX IMPEDANCE (Ohm)	JACKET DIAMETER (in)	NUMBER OF SHIELDS	VELOCITY FACTOR (%)	MAX. POWER HANDLING AT 1 GHz (W)	JACKET MATERIAL	PRICE PER FOOT		ROW
	MAXIMUM FREQUENCY (GHz.)	CONDUCTOR DIAM.(in) [strands]	RF SHIELDING (min dB)	ATTENUATION AT 1 GHz. (dB/100 ft)	MAXIMUM OPERATING VOLTAGE (V RMS)	MINIMUM BEND RADIUS (in)	1-99 FT 500-999 FT	100-499 FT 1000 + FT	
<b>SEMIRIGID AND FORMABLE</b>									
<a href="#">PECX003</a>	50	0.02[1]	1	77	188	0.25	\$18.46	\$17.54	6
	72			20			\$16.61	\$15.88	
<a href="#">PECX004</a>	50	0.02[1]	1	77	188	0.25	\$20.78	\$19.74	7
	72			20			\$18.70	\$17.87	
<a href="#">PECX005</a>	50	0.023[1]	1	77	314	0.25	\$8.46	\$8.04	8
	62			17			\$7.61	\$7.28	
<a href="#">PECX006</a>	50	0.023[1]	1	77	231	0.25	\$10.77	\$10.23	9
	62			17			\$9.69	\$9.26	
<a href="#">PECX007</a>	50	0.04[1]	1	77	580	0.5	\$12.06	\$11.46	10
	34			10.5			\$10.85	\$10.37	
<a href="#">PECX008</a>	50	0.04[1]	1	77	580	0.5	\$14.39	\$13.67	11
	34			10.5			\$12.95	\$12.38	
<a href="#">RG401/U (2,8)</a>	50	0.064[1]	1	70	1,400		\$23.06	\$21.91	12
	20			7.5	3,000		\$20.75	\$19.83	
<a href="#">RG402/U (3,8)</a>	50	0.036[1]	1	70	450		\$7.60	\$7.22	13
	34			11.1			\$6.84	\$6.54	
<a href="#">RG402/U-STRAIGHT</a>	50	0.036[1]	1	70	450		\$8.04	\$7.64	14
	33			12			\$7.24	\$6.91	
<a href="#">RG405/U (3,8)</a>	50	0.02[1]	1	70	130		\$7.21	\$6.85	15
	40		-110	22			\$6.49	\$6.20	
<a href="#">RG405/U-STRAIGHT</a>	50	0.02[1]	1	70	130		\$9.56	\$9.08	16
	40		-110	22			\$8.60	\$8.22	
<a href="#">SPP-250-LLPL</a>	50	0.280	1	76	650	FEP	\$5.58	\$5.58	17
	5.8	0.068[1]	100	5.5		1.25	\$5.58	\$5.58	
<a href="#">TFT-402-LF</a>	50	0.160	2	76		FEP	\$2.02	\$2.02	18
	5.8	0.037[1]	80			0.75	\$2.02	\$2.02	
<b>TWINAX</b>									
<a href="#">PE-S330 (TWINAX)</a>	100	0.330	2			PVC	\$4.76	\$4.52	19
	0.4	0.037[7]			300		\$4.28	\$4.09	
<a href="#">RG108A/U (TWINAX)</a>	78	0.235	1	66	30	PVC	\$2.67	\$2.54	20
	1	0.038[7]		34.6			\$2.40	\$2.30	

Coaxial Cables

See Our Website For Current Pricing & Real-Time Stock Availability!

**NOTES:**

- (1) P = PLENUM CABLE, NEC 725-2(b) CLASS 2 - REQUIRES SPECIAL CONNECTORS
- (2) SEMI-RIGID CABLE, SOLD IN 5 FEET, STRAIGHT PIECES ONLY
- (3) SEMI-RIGID CABLE, SOLD IN EITHER 5 FEET, STRAIGHT PIECES OR COILS OF 50 FEET
- (4) RE-SHAPEABLE VERSION OF RG402/U
- (5) RE-SHAPEABLE VERSION OF RG405/U
- (6) TINNED ALUMINUM VERSION OF PE-047SR
- (7) TINNED ALUMINUM VERSION OF RG401/U
- (8) BARE COPPER JACKET
- (9) TINNED ALUMINUM VERSION OF RG405/U
- (10) TINNED ALUMINUM VERSION OF RG402/U
- (11) RE-SHAPEABLE VERSION OF RG401/U
- (12) RE-SHAPEABLE VERSION OF PE-047SR
- (13) JACKETED RE-SHAPEABLE VERSION OF RG402/U
- (14) JACKETED RE-SHAPEABLE VERSION OF RG405/U

**MATERIALS:**

- Al (Tn) TIN PLATED ALUMINUM
- Cu BARE COPPER
- Cu (Tn) TIN PLATED COPPER
- FEP FLUORINATED ETHYLENE PROPYLENE
- LSZH LOW SMOKE ZERO HALOGEN
- PE POLYETHYLENE
- PTFE POLYTETRAFLUOROETHYLENE
- PTFE (FR) FIBERGLASS REINFORCED PTFE
- PVC POLYVINYLCHLORIDE
- PVC (NC) NON-CONTAMINATED PVC
- PVC (FR) FIBERGLASS REINFORCED PVC

# Connector Selection Guide

## 3 Easy Ways to Find your Product.....

### 1. Search by PE Part Number

If you know the PE part number you are searching for, please reference our Part Number Index on Page [355](#)

### 2. Quick Reference Guide

(Page number refers to first appearance of product in the Connector Section)

Connector Series	Page	Connector Series	Page	Connector Series	Page	Connector Series	Page
1.0/2.3	<a href="#">205</a>	75 Ohm N	<a href="#">262</a>	FME	<a href="#">221</a>	Rev. Pol. N	<a href="#">232</a>
1.0mm	<a href="#">205</a>	75 Ohm RCA	<a href="#">262</a>	GR874	<a href="#">221</a>	Rev. Pol. SMA	<a href="#">242</a>
1.85mm	<a href="#">206</a>	75 Ohm SMB	<a href="#">263</a>	HN	<a href="#">221</a>	Rev. Pol. TNC	<a href="#">256</a>
10-32	<a href="#">212</a>	75 Ohm SMB Positive Snap	<a href="#">264</a>	LC	<a href="#">222</a>	Rev. Thread SMA	<a href="#">242</a>
2.4mm	<a href="#">207</a>	75 Ohm SMC	<a href="#">265</a>	MC-Card	<a href="#">222</a>	SC	<a href="#">234</a>
2.92mm	<a href="#">207</a>	75 Ohm TNC	<a href="#">265</a>	MCX	<a href="#">223</a>	SHV	<a href="#">234</a>
3.5mm	<a href="#">208</a>	7mm	<a href="#">208</a>	MHV	<a href="#">224</a>	SMA	<a href="#">240</a>
3/4"-20 Twinax	<a href="#">266</a>	Banana	<a href="#">266</a>	Mini SMP	<a href="#">225</a>	SMB	<a href="#">244</a>
4.1/9.5 Mini DIN	<a href="#">208</a>	BMA	<a href="#">213</a>	Mini UHF	<a href="#">225</a>	SMC	<a href="#">246</a>
4.3-10	<a href="#">209</a>	BNC	<a href="#">216</a>	MMBX	<a href="#">227</a>	SMP	<a href="#">247</a>
7/16 DIN	<a href="#">211</a>	BNC Twinax	<a href="#">266</a>	MMCX	<a href="#">226</a>	SSMA	<a href="#">249</a>
75 Ohm 1.0/2.3	<a href="#">257</a>	C	<a href="#">218</a>	N	<a href="#">231</a>	SSMB	<a href="#">250</a>
75 Ohm 1.6/5.6	<a href="#">257</a>	D-Sub	<a href="#">219</a>	NMO Mount	<a href="#">232</a>	SSMC	<a href="#">251</a>
75 Ohm BNC	<a href="#">259</a>	D-Subminiature	<a href="#">257</a>	QMA	<a href="#">233</a>	TNC	<a href="#">254</a>
75 Ohm F	<a href="#">260</a>	Double Banana	<a href="#">266</a>	QN	<a href="#">233</a>	UHF	<a href="#">256</a>
75 Ohm MCX	<a href="#">261</a>	FAKRA	<a href="#">220</a>	Rev. Pol. BNC	<a href="#">217</a>	UMCX	<a href="#">256</a>
75 Ohm Mini SMB	<a href="#">261</a>			Rev. Pol. MCX	<a href="#">224</a>		

### 3. Connector Locator

Connector Type	Page
<b>1.0/2.3 Jack Connectors</b>	
Right Angle, Bulkhead, Cable Connectors	<a href="#">205</a>
Right Angle, PCB Mount	<a href="#">205</a>
Straight, Bulkhead, Cable Connectors	<a href="#">205</a>
Straight, Bulkhead, PCB Mount	<a href="#">205</a>
Straight, PCB Mount	<a href="#">205</a>
<b>1.0/2.3 Plug Connectors</b>	
Right Angle, Cable Connectors	<a href="#">205</a>
Straight, Cable Connectors	<a href="#">205</a>
<b>1.0mm Female Connectors</b>	
Straight, PCB Mount	<a href="#">205</a>
<b>1.85mm Female Connectors</b>	
Straight, Bulkhead, Cable Connectors	<a href="#">206</a>
Straight, Cable Connectors	<a href="#">206</a>
Straight, PCB Mount	<a href="#">206</a>
<b>1.85mm Male Connectors</b>	
Straight, Cable Connectors	<a href="#">205</a>
Straight, PCB Mount	<a href="#">205</a>
<b>10-32 Female Connectors</b>	
Right Angle, PCB Mount	<a href="#">212</a>
Straight, Bulkhead, Cable Connectors	<a href="#">211</a>
Straight, Bulkhead, Terminal	<a href="#">212</a>
Straight, Cable Connectors	<a href="#">211</a>

Connector Type	Page
Straight, PCB Mount	<a href="#">211</a>
<b>10-32 Male Connectors</b>	
Right Angle, Cable Connectors	<a href="#">211</a>
Straight, Cable Connectors	<a href="#">211</a>
<b>2.4mm Female Connectors</b>	
Straight, 4 Hole Flange, Terminal	<a href="#">207</a>
Straight, Bulkhead, Cable Connectors	<a href="#">206</a>
Straight, Cable Connectors	<a href="#">206</a>
Straight, PCB Mount	<a href="#">206</a>
<b>2.4mm Male Connectors</b>	
Straight, 2 Hole Flange, Terminal	<a href="#">206</a>
Straight, Cable Connectors	<a href="#">206</a>
Straight, PCB Mount	<a href="#">206</a>
<b>2.92mm Female Connectors</b>	
Straight, 2 Hole Flange, Field Replaceable Contact	<a href="#">207</a>
Straight, Bulkhead, Cable Connectors	<a href="#">207</a>
Straight, Cable Connectors	<a href="#">207</a>
Straight, PCB Mount	<a href="#">207</a>
<b>2.92mm Male Connectors</b>	
Straight, 2 Hole Flange, Field Replaceable Contact	<a href="#">207</a>
Straight, Cable Connectors	<a href="#">207</a>
Straight, PCB Mount	<a href="#">207</a>
<b>3.5mm Female Connectors</b>	

Connectors



Technical Support  
+1 (949) 261-1920



Same-Day Shipping,  
Even Custom  
Cable Assemblies

# Connector Locator

Connector Type	Page
Straight, Bulkhead, Cable Connectors	<a href="#">208</a>
Straight, Cable Connectors	<a href="#">208</a>
<b>3.5mm Male Connectors</b>	
Straight, Cable Connectors	<a href="#">208</a>
<b>4.1/9.5 Mini DIN Female Connectors</b>	
Straight, Cable Connectors	<a href="#">208</a>
<b>4.1/9.5 Mini DIN Male Connectors</b>	
Right Angle, Cable Connectors	<a href="#">208</a>
Straight, Cable Connectors	<a href="#">208</a>
<b>4.3-10 Female Connectors</b>	
Straight, 4 Hole Flange, Cable Connectors	<a href="#">209</a>
Straight, 4 Hole Flange, Terminal	<a href="#">209</a>
Straight, Cable Connectors	<a href="#">209</a>
<b>4.3-10 Male Connectors</b>	
Right Angle, Cable Connectors	<a href="#">209</a>
Straight, Cable Connectors	<a href="#">208</a>
<b>7/16 DIN Female Connectors</b>	
Straight, 4 Hole Flange, Cable Connectors	<a href="#">211</a>
Straight, 4 Hole Flange, Terminal	<a href="#">211</a>
Straight, Bulkhead, Cable Connectors	<a href="#">210</a>
Straight, Bulkhead, Terminal	<a href="#">211</a>
Straight, Cable Connectors	<a href="#">210</a>
<b>7/16 DIN Male Connectors</b>	
Right Angle, Cable Connectors	<a href="#">210</a>
Straight, Cable Connectors	<a href="#">209</a>
<b>75 Ohm 1.0/2.3 Jack Connectors</b>	
Right Angle, Bulkhead, PCB Mount	<a href="#">257</a>
Straight, Bulkhead, PCB Mount	<a href="#">257</a>
<b>75 Ohm 1.0/2.3 Plug Connectors</b>	
Straight, Cable Connectors	<a href="#">257</a>
<b>75 Ohm 1.6/5.6 Jack Connectors</b>	
Right Angle, Bulkhead, Cable Connectors	<a href="#">257</a>
Right Angle, PCB Mount	<a href="#">257</a>
Straight, Bulkhead, Cable Connectors	<a href="#">257</a>
Straight, Bulkhead, PCB Mount	<a href="#">257</a>
<b>75 Ohm 1.6/5.6 Plug Connectors</b>	
Right Angle, Cable Connectors	<a href="#">257</a>
Straight, Cable Connectors	<a href="#">257</a>
<b>75 Ohm BNC Female Connectors</b>	
Right Angle, 4 Hole Flange, Terminal	<a href="#">259</a>
Right Angle, Bulkhead, Terminal	<a href="#">259</a>
Straight, 4 Hole Flange, Cable Connectors	<a href="#">259</a>
Straight, 4 Hole Flange, Terminal	<a href="#">259</a>
Straight, Bulkhead, Cable Connectors	<a href="#">259</a>
Straight, Bulkhead, PCB Mount	<a href="#">259</a>
Straight, Bulkhead, Terminal	<a href="#">259</a>
Straight, Cable Connectors	<a href="#">258</a>
Straight, PCB Mount	<a href="#">258</a>
<b>75 Ohm BNC Male Connectors</b>	
Right Angle, Cable Connectors	<a href="#">258</a>
Straight, 4 Hole Flange, Terminal	<a href="#">258</a>
Straight, Bulkhead, Terminal	<a href="#">258</a>
Straight, Cable Connectors	<a href="#">258</a>

Connector Type	Page
<b>75 Ohm F Female Connectors</b>	
Right Angle, Bulkhead, PCB Mount	<a href="#">260</a>
Right Angle, PCB Mount	<a href="#">260</a>
Straight, 4 Hole Flange, Terminal	<a href="#">260</a>
Straight, Bulkhead, Cable Connectors	<a href="#">260</a>
Straight, Bulkhead, PCB Mount	<a href="#">260</a>
Straight, Bulkhead, Terminal	<a href="#">260</a>
Straight, PCB Mount	<a href="#">260</a>
Straight, Thread-In, Terminal	<a href="#">260</a>
<b>75 Ohm F Male Connectors</b>	
Right Angle, Cable Connectors	<a href="#">260</a>
Straight, Cable Connectors	<a href="#">259</a>
<b>75 Ohm MCX Jack Connectors</b>	
Right Angle, PCB Mount	<a href="#">261</a>
Straight, Cable Connectors	<a href="#">261</a>
Straight, PCB Mount	<a href="#">261</a>
<b>75 Ohm MCX Plug Connectors</b>	
Right Angle, Cable Connectors	<a href="#">261</a>
Straight, Cable Connectors	<a href="#">260</a>
Straight, PCB Mount	<a href="#">260</a>
<b>75 Ohm Mini SMB Jack Connectors</b>	
Right Angle, Bulkhead, PCB Mount	<a href="#">261</a>
Right Angle, PCB Mount	<a href="#">261</a>
Straight, 2 Hole Flange, Terminal	<a href="#">261</a>
Straight, Bulkhead, PCB Mount	<a href="#">261</a>
Straight, Cable Connectors	<a href="#">261</a>
Straight, PCB Mount	<a href="#">261</a>
<b>75 Ohm Mini SMB Plug Connectors</b>	
Right Angle, Cable Connectors	<a href="#">261</a>
Straight, Cable Connectors	<a href="#">261</a>
<b>75 Ohm N Female Connectors</b>	
Straight, 4 Hole Flange, Terminal	<a href="#">262</a>
Straight, Bulkhead, Terminal	<a href="#">262</a>
Straight, Cable Connectors	<a href="#">262</a>
<b>75 Ohm N Male Connectors</b>	
Right Angle, Cable Connectors	<a href="#">262</a>
Straight, 4 Hole Flange, Terminal	<a href="#">262</a>
Straight, Cable Connectors	<a href="#">262</a>
<b>75 Ohm RCA Female Connectors</b>	
Straight, Bulkhead, Cable Connectors	<a href="#">262</a>
<b>75 Ohm RCA Male Connectors</b>	
Right Angle, Cable Connectors	<a href="#">262</a>
Straight, Cable Connectors	<a href="#">262</a>
<b>75 Ohm SMB Jack Connectors</b>	
Right Angle, Bulkhead, Terminal	<a href="#">263</a>
Right Angle, PCB Mount	<a href="#">263</a>
Straight, Bulkhead, Cable Connectors	<a href="#">263</a>
Straight, Bulkhead, Terminal	<a href="#">263</a>
Straight, Cable Connectors	<a href="#">263</a>
Straight, PCB Mount	<a href="#">263</a>
<b>75 Ohm SMB Plug Connectors</b>	
Right Angle, Cable Connectors	<a href="#">263</a>
Right Angle, PCB Mount	<a href="#">263</a>

# Connector Locator

Connector Type	Page
Straight, Bulkhead, Terminal	<a href="#">263</a>
Straight, Cable Connectors	<a href="#">263</a>
Straight, PCB Mount	<a href="#">263</a>
<b>75 Ohm SMB Positive Snap Plug Connectors</b>	
Right Angle, Cable Connectors	<a href="#">264</a>
Straight, Cable Connectors	<a href="#">264</a>
<b>75 Ohm SMC Jack Connectors</b>	
Right Angle, PCB Mount	<a href="#">265</a>
Straight, Bulkhead, Cable Connectors	<a href="#">264</a>
Straight, Bulkhead, Terminal	<a href="#">264</a>
Straight, Cable Connectors	<a href="#">264</a>
Straight, PCB Mount	<a href="#">264</a>
<b>75 Ohm SMC Plug Connectors</b>	
Right Angle, Cable Connectors	<a href="#">264</a>
Right Angle, PCB Mount	<a href="#">264</a>
Straight, Bulkhead, Terminal	<a href="#">264</a>
Straight, Cable Connectors	<a href="#">264</a>
<b>75 Ohm TNC Female Connectors</b>	
Straight, 4 Hole Flange, Terminal	<a href="#">265</a>
Straight, Bulkhead, Cable Connectors	<a href="#">265</a>
Straight, Bulkhead, Terminal	<a href="#">265</a>
<b>75 Ohm TNC Male Connectors</b>	
Right Angle, Cable Connectors	<a href="#">265</a>
Straight, Cable Connectors	<a href="#">265</a>
<b>78 Ohm BNC Twinax Jack Connectors</b>	
Right Angle, PCB Mount	<a href="#">266</a>
Straight, 4 Hole Flange, Terminal	<a href="#">266</a>
Straight, Bulkhead, Cable Connectors	<a href="#">266</a>
Straight, Bulkhead, Terminal	<a href="#">266</a>
Straight, Cable Connectors	<a href="#">265</a>
Straight, PCB Mount	<a href="#">265</a>
<b>78 Ohm BNC Twinax Plug Connectors</b>	
Straight, Cable Connectors	<a href="#">265</a>
<b>7mm Sexless Connectors</b>	
Straight, Cable Connectors	<a href="#">208</a>
<b>95 Ohm 3/4"-20 Twinax Female Connectors</b>	
Straight, 4 Hole Flange, Terminal	<a href="#">266</a>
Straight, Bulkhead, Terminal	<a href="#">266</a>
Straight, Cable Connectors	<a href="#">266</a>
<b>95 Ohm 3/4"-20 Twinax Male Connectors</b>	
Straight, Cable Connectors	<a href="#">266</a>
<b>Banana Plug Connectors</b>	
Straight, Cable Connectors	<a href="#">266</a>
<b>BMA Jack Connectors</b>	
Right Angle, 2 Hole Flange, Cable Connectors	<a href="#">213</a>
Straight, 2 Hole Flange, Cable Connectors	<a href="#">213</a>
Straight, 2 Hole Flange, Terminal	<a href="#">213</a>
Straight, 4 Hole Flange, Terminal	<a href="#">213</a>
Straight, Bulkhead, Cable Connectors	<a href="#">213</a>
Straight, Cable Connectors	<a href="#">212</a>
Straight, PCB Mount	<a href="#">213</a>
Straight, Terminal	<a href="#">213</a>
Straight, Thread-In, Terminal	<a href="#">213</a>

Connector Type	Page
<b>BMA Plug Connectors</b>	
Right Angle, PCB Mount	<a href="#">212</a>
Straight, 2 Hole Flange, Field Replaceable Contact	<a href="#">212</a>
Straight, 2 Hole Flange, Terminal	<a href="#">212</a>
Straight, 4 Hole Flange, Terminal	<a href="#">212</a>
Straight, Bulkhead, Cable Connectors	<a href="#">212</a>
Straight, PCB Mount	<a href="#">212</a>
Straight, Thread-In, Terminal	<a href="#">212</a>
<b>BNC Female Connectors</b>	
Right Angle, 4 Hole Flange, Terminal	<a href="#">216</a>
Right Angle, Bulkhead, Terminal	<a href="#">216</a>
Straight, 4 Hole Flange, Cable Connectors	<a href="#">216</a>
Straight, 4 Hole Flange, Terminal	<a href="#">216</a>
Straight, Bulkhead, Cable Connectors	<a href="#">215</a>
Straight, Bulkhead, PCB Mount	<a href="#">215</a>
Straight, Bulkhead, Terminal	<a href="#">215</a>
Straight, Cable Connectors	<a href="#">215</a>
Straight, PCB Mount	<a href="#">215</a>
<b>BNC Male Connectors</b>	
Right Angle, Cable Connectors	<a href="#">214</a>
Straight, 4 Hole Flange, Terminal	<a href="#">214</a>
Straight, Bulkhead, Terminal	<a href="#">214</a>
Straight, Cable Connectors	<a href="#">213</a>
<b>C Female Connectors</b>	
Straight, 4 Hole Flange, Cable Connectors	<a href="#">218</a>
Straight, 4 Hole Flange, Terminal	<a href="#">218</a>
Straight, Bulkhead, Cable Connectors	<a href="#">218</a>
Straight, Bulkhead, Terminal	<a href="#">218</a>
Straight, Cable Connectors	<a href="#">218</a>
<b>C Male Connectors</b>	
Right Angle, Cable Connectors	<a href="#">218</a>
Straight, 4 Hole Flange, Terminal	<a href="#">218</a>
Straight, Cable Connectors	<a href="#">217</a>
<b>D-Sub Plug Connectors</b>	
Right Angle, Cable Connectors	<a href="#">219</a>
Straight, Cable Connectors	<a href="#">219</a>
<b>D-Sub Receptacle Connectors</b>	
Right Angle, Cable Connectors	<a href="#">219</a>
Straight, Cable Connectors	<a href="#">219</a>
<b>D-Subminiature Plug Connectors</b>	
Right Angle, Cable Connectors	<a href="#">257</a>
<b>D-Subminiature Receptacle Connectors</b>	
Right Angle, Cable Connectors	<a href="#">257</a>
<b>Double Banana Plug Connectors</b>	
Straight, Cable Connectors	<a href="#">266</a>
<b>FAKRA Jack Connectors</b>	
Right Angle, Cable Connectors	<a href="#">220</a>
Right Angle, PCB Mount	<a href="#">220</a>
Straight, Cable Connectors	<a href="#">220</a>
<b>FAKRA Plug Connectors</b>	
Right Angle, PCB Mount	<a href="#">220</a>
Straight, Cable Connectors	<a href="#">219</a>
Straight, PCB Mount	<a href="#">219</a>

Connectors



Technical Support  
+1 (949) 261-1920



Same-Day Shipping,  
Even Custom  
Cable Assemblies

# Connector Locator

Connector Type	Page
<b>FME Jack Connectors</b>	
Straight, Cable Connectors	<a href="#">221</a>
<b>FME Plug Connectors</b>	
Straight, Bulkhead, Terminal	<a href="#">220</a>
Straight, Cable Connectors	<a href="#">220</a>
<b>GR874 Sexless Connectors</b>	
Straight, Cable Connectors	<a href="#">221</a>
<b>HN Female Connectors</b>	
Straight, 4 Hole Flange, Terminal	<a href="#">221</a>
Straight, Bulkhead, Terminal	<a href="#">221</a>
Straight, Cable Connectors	<a href="#">221</a>
<b>HN Male Connectors</b>	
Right Angle, Cable Connectors	<a href="#">221</a>
Straight, Cable Connectors	<a href="#">221</a>
<b>LC Female Connectors</b>	
Straight, 4 Hole Flange, Terminal	<a href="#">222</a>
Straight, Cable Connectors	<a href="#">222</a>
<b>LC Male Connectors</b>	
Right Angle, Cable Connectors	<a href="#">222</a>
Straight, Cable Connectors	<a href="#">222</a>
<b>MC-Card Plug Connectors</b>	
Right Angle, Cable Connectors	<a href="#">222</a>
Straight, Cable Connectors	<a href="#">222</a>
<b>MCX Jack Connectors</b>	
Right Angle, Bulkhead, Terminal	<a href="#">223</a>
Right Angle, PCB Mount	<a href="#">223</a>
Straight, 2 Hole Flange, Terminal	<a href="#">223</a>
Straight, Bulkhead, Cable Connectors	<a href="#">223</a>
Straight, Bulkhead, Terminal	<a href="#">223</a>
Straight, Cable Connectors	<a href="#">223</a>
Straight, PCB Mount	<a href="#">223</a>
<b>MCX Plug Connectors</b>	
Right Angle, Cable Connectors	<a href="#">222</a>
Right Angle, PCB Mount	<a href="#">223</a>
Straight, Cable Connectors	<a href="#">222</a>
Straight, PCB Mount	<a href="#">222</a>
<b>MHV Female Connectors</b>	
Straight, 4 Hole Flange, Cable Connectors	<a href="#">224</a>
Straight, 4 Hole Flange, Terminal	<a href="#">224</a>
Straight, Bulkhead, Cable Connectors	<a href="#">224</a>
Straight, Bulkhead, Terminal	<a href="#">224</a>
Straight, Cable Connectors	<a href="#">224</a>
<b>MHV Male Connectors</b>	
Right Angle, Cable Connectors	<a href="#">224</a>
Straight, Cable Connectors	<a href="#">224</a>
<b>Mini SMP Female Connectors</b>	
Right Angle, Cable Connectors	<a href="#">225</a>
Straight, Cable Connectors	<a href="#">225</a>
<b>Mini SMP Male Connectors</b>	
Right Angle, PCB Mount	<a href="#">225</a>
Straight, PCB Mount	<a href="#">225</a>
Straight, Solder, Terminal	<a href="#">225</a>
<b>Mini UHF Female Connectors</b>	

Connector Type	Page
Straight, 4 Hole Flange, Terminal	<a href="#">225</a>
Straight, Bulkhead, Cable Connectors	<a href="#">225</a>
Straight, Bulkhead, PCB Mount	<a href="#">225</a>
Straight, Bulkhead, Terminal	<a href="#">225</a>
Straight, Cable Connectors	<a href="#">225</a>
<b>Mini UHF Male Connectors</b>	
Straight, Cable Connectors	<a href="#">225</a>
<b>MMBX Jack Connectors</b>	
Straight, PCB Mount	<a href="#">227</a>
Straight, Thread-In, Terminal	<a href="#">227</a>
<b>MMBX Plug Connectors</b>	
Right Angle, Cable Connectors	<a href="#">226</a>
Straight, Cable Connectors	<a href="#">226</a>
Straight, PCB Mount	<a href="#">226</a>
<b>MMCX Jack Connectors</b>	
Right Angle, PCB Mount	<a href="#">226</a>
Straight, Cable Connectors	<a href="#">226</a>
Straight, PCB Mount	<a href="#">226</a>
<b>MMCX Plug Connectors</b>	
Right Angle, Cable Connectors	<a href="#">226</a>
Straight, Cable Connectors	<a href="#">226</a>
Straight, PCB Mount	<a href="#">226</a>
<b>N Female Connectors</b>	
Right Angle, 4 Hole Flange, Terminal	<a href="#">231</a>
Right Angle, Bulkhead, PCB Mount	<a href="#">231</a>
Straight, 2 Hole Flange, Terminal	<a href="#">231</a>
Straight, 4 Hole Flange, Cable Connectors	<a href="#">231</a>
Straight, 4 Hole Flange, Terminal	<a href="#">231</a>
Straight, Bulkhead, Cable Connectors	<a href="#">230</a>
Straight, Bulkhead, PCB Mount	<a href="#">231</a>
Straight, Bulkhead, Terminal	<a href="#">230</a>
Straight, Cable Connectors	<a href="#">229</a>
Straight, PCB Mount	<a href="#">230</a>
Straight, Press-In, Terminal	<a href="#">231</a>
<b>N Male Connectors</b>	
Right Angle, Cable Connectors	<a href="#">228</a>
Straight, 4 Hole Flange, Terminal	<a href="#">228</a>
Straight, Bulkhead, Terminal	<a href="#">228</a>
Straight, Cable Connectors	<a href="#">227</a>
<b>NMO Mount Sexless Connectors</b>	
Straight, Cable Connectors	<a href="#">232</a>
<b>QMA Female Connectors</b>	
Right Angle, PCB Mount	<a href="#">233</a>
Straight, Bulkhead, Cable Connectors	<a href="#">233</a>
Straight, Cable Connectors	<a href="#">233</a>
Straight, PCB Mount	<a href="#">233</a>
<b>QMA Male Connectors</b>	
Right Angle, Cable Connectors	<a href="#">232</a>
Straight, Cable Connectors	<a href="#">232</a>
<b>QN Female Connectors</b>	
Straight, 4 Hole Flange, Terminal	<a href="#">233</a>
Straight, Bulkhead, Cable Connectors	<a href="#">233</a>
<b>QN Male Connectors</b>	



# Connector Locator

Connector Type	Page
Right Angle, Cable Connectors	<a href="#">233</a>
Straight, Cable Connectors	<a href="#">233</a>
<b>Reverse Polarity BNC Female Connectors</b>	
Right Angle, 4 Hole Flange, Terminal	<a href="#">217</a>
Right Angle, Bulkhead, Terminal	<a href="#">217</a>
Straight, 4 Hole Flange, Cable Connectors	<a href="#">217</a>
Straight, 4 Hole Flange, Terminal	<a href="#">217</a>
Straight, Bulkhead, Cable Connectors	<a href="#">217</a>
Straight, Bulkhead, Terminal	<a href="#">217</a>
Straight, Cable Connectors	<a href="#">217</a>
<b>Reverse Polarity BNC Male Connectors</b>	
Right Angle, Cable Connectors	<a href="#">216</a>
Straight, 4 Hole Flange, Terminal	<a href="#">216</a>
Straight, Cable Connectors	<a href="#">216</a>
<b>Reverse Polarity MCX Jack Connectors</b>	
Right Angle, Bulkhead, PCB Mount	<a href="#">224</a>
Straight, Bulkhead, Cable Connectors	<a href="#">223</a>
Straight, Bulkhead, PCB Mount	<a href="#">223</a>
<b>Reverse Polarity MCX Plug Connectors</b>	
Right Angle, Cable Connectors	<a href="#">223</a>
Straight, Cable Connectors	<a href="#">223</a>
<b>Reverse Polarity N Female Connectors</b>	
Straight, Cable Connectors	<a href="#">232</a>
<b>Reverse Polarity N Male Connectors</b>	
Straight, Cable Connectors	<a href="#">232</a>
<b>Reverse Polarity SMA Female Connectors</b>	
Right Angle, Bulkhead, PCB Mount	<a href="#">242</a>
Right Angle, PCB Mount	<a href="#">242</a>
Straight, 2 Hole Flange, Terminal	<a href="#">241</a>
Straight, 4 Hole Flange, Terminal	<a href="#">242</a>
Straight, Bulkhead, Cable Connectors	<a href="#">241</a>
Straight, Bulkhead, PCB Mount	<a href="#">241</a>
Straight, Bulkhead, Terminal	<a href="#">241</a>
Straight, Cable Connectors	<a href="#">241</a>
Straight, PCB Mount	<a href="#">241</a>
<b>Reverse Polarity SMA Male Connectors</b>	
Right Angle, Cable Connectors	<a href="#">240</a>
Straight, Cable Connectors	<a href="#">240</a>
<b>Reverse Polarity TNC Female Connectors</b>	
Right Angle, Bulkhead, PCB Mount	<a href="#">256</a>
Straight, 4 Hole Flange, Terminal	<a href="#">256</a>
Straight, Bulkhead, Cable Connectors	<a href="#">255</a>
Straight, Bulkhead, Terminal	<a href="#">255</a>
Straight, Cable Connectors	<a href="#">255</a>
<b>Reverse Polarity TNC Male Connectors</b>	
Right Angle, Cable Connectors	<a href="#">255</a>
Straight, 4 Hole Flange, Terminal	<a href="#">255</a>
Straight, Cable Connectors	<a href="#">254</a>
<b>Reverse Thread SMA Female Connectors</b>	
Right Angle, PCB Mount	<a href="#">242</a>
Straight, 4 Hole Flange, Terminal	<a href="#">242</a>
Straight, Bulkhead, Cable Connectors	<a href="#">242</a>
Straight, Cable Connectors	<a href="#">242</a>

Connector Type	Page
Straight, PCB Mount	<a href="#">242</a>
<b>Reverse Thread SMA Male Connectors</b>	
Right Angle, Cable Connectors	<a href="#">242</a>
Straight, Cable Connectors	<a href="#">242</a>
<b>SC Female Connectors</b>	
Straight, 4 Hole Flange, Terminal	<a href="#">234</a>
Straight, Bulkhead, Terminal	<a href="#">234</a>
<b>SC Male Connectors</b>	
Right Angle, Cable Connectors	<a href="#">234</a>
Straight, Cable Connectors	<a href="#">234</a>
<b>SHV Jack Connectors</b>	
Straight, 4 Hole Flange, Terminal	<a href="#">234</a>
Straight, Bulkhead, Cable Connectors	<a href="#">234</a>
Straight, Bulkhead, Terminal	<a href="#">234</a>
<b>SHV Plug Connectors</b>	
Straight, Bulkhead, Terminal	<a href="#">234</a>
Straight, Cable Connectors	<a href="#">234</a>
<b>SMA Female Connectors</b>	
Right Angle, 2 Hole Flange, Terminal	<a href="#">240</a>
Right Angle, 4 Hole Flange, Field Replaceable Contact	<a href="#">240</a>
Right Angle, 4 Hole Flange, Terminal	<a href="#">240</a>
Right Angle, Bulkhead, PCB Mount	<a href="#">240</a>
Right Angle, Bulkhead, Terminal	<a href="#">240</a>
Right Angle, PCB Mount	<a href="#">240</a>
Straight, 2 Hole Flange, Cable Connectors	<a href="#">239</a>
Straight, 2 Hole Flange, Field Replaceable Contact	<a href="#">239</a>
Straight, 2 Hole Flange, Terminal	<a href="#">239</a>
Straight, 4 Hole Flange, Cable Connectors	<a href="#">239</a>
Straight, 4 Hole Flange, Field Replaceable Contact	<a href="#">239</a>
Straight, 4 Hole Flange, Terminal	<a href="#">239</a>
Straight, Bulkhead, Cable Connectors	<a href="#">238</a>
Straight, Bulkhead, PCB Mount	<a href="#">238</a>
Straight, Bulkhead, Terminal	<a href="#">238</a>
Straight, Cable Connectors	<a href="#">237</a>
Straight, PCB Mount	<a href="#">237</a>
Straight, Press-In, Terminal	<a href="#">240</a>
<b>SMA Male Connectors</b>	
Right Angle, Cable Connectors	<a href="#">236</a>
Right Angle, PCB Mount	<a href="#">237</a>
Straight, 2 Hole Flange, Field Replaceable Contact	<a href="#">236</a>
Straight, 2 Hole Flange, Terminal	<a href="#">236</a>
Straight, 4 Hole Flange, Field Replaceable Contact	<a href="#">236</a>
Straight, 4 Hole Flange, Terminal	<a href="#">236</a>
Straight, Bulkhead, Terminal	<a href="#">236</a>
Straight, Cable Connectors	<a href="#">235</a>
Straight, PCB Mount	<a href="#">235</a>
<b>SMB Jack Connectors</b>	
Right Angle, Bulkhead, PCB Mount	<a href="#">244</a>
Right Angle, Bulkhead, Terminal	<a href="#">244</a>
Right Angle, PCB Mount	<a href="#">244</a>
Straight, 2 Hole Flange, Terminal	<a href="#">244</a>
Straight, 4 Hole Flange, Terminal	<a href="#">244</a>
Straight, Bulkhead, Cable Connectors	<a href="#">244</a>









# Connector Locator

Connector Type	Page
Straight, Bulkhead, PCB Mount	<a href="#">244</a>
Straight, Bulkhead, Terminal	<a href="#">244</a>
Straight, Cable Connectors	<a href="#">243</a>
Straight, PCB Mount	<a href="#">243</a>
<b>SMB Plug Connectors</b>	
Right Angle, Cable Connectors	<a href="#">243</a>
Right Angle, PCB Mount	<a href="#">243</a>
Straight, Bulkhead, Terminal	<a href="#">243</a>
Straight, Cable Connectors	<a href="#">243</a>
Straight, PCB Mount	<a href="#">243</a>
<b>SMC Jack Connectors</b>	
Right Angle, Bulkhead, PCB Mount	<a href="#">246</a>
Right Angle, Bulkhead, Terminal	<a href="#">245</a>
Right Angle, PCB Mount	<a href="#">245</a>
Straight, 4 Hole Flange, Terminal	<a href="#">245</a>
Straight, Bulkhead, Cable Connectors	<a href="#">245</a>
Straight, Bulkhead, PCB Mount	<a href="#">245</a>
Straight, Bulkhead, Terminal	<a href="#">245</a>
Straight, Cable Connectors	<a href="#">245</a>
Straight, PCB Mount	<a href="#">245</a>
<b>SMC Plug Connectors</b>	
Right Angle, Cable Connectors	<a href="#">245</a>
Right Angle, PCB Mount	<a href="#">245</a>
Straight, Cable Connectors	<a href="#">244</a>
Straight, PCB Mount	<a href="#">244</a>
<b>SMP Female Connectors</b>	
Right Angle, Cable Connectors	<a href="#">247</a>
Straight, Cable Connectors	<a href="#">247</a>
Straight, PCB Mount	<a href="#">247</a>
<b>SMP Male Connectors</b>	
Right Angle, PCB Mount	<a href="#">247</a>
Straight, 2 Hole Flange, Cable Connectors	<a href="#">246</a>
Straight, 2 Hole Flange, Shroud	<a href="#">246</a>
Straight, 2 Hole Flange, Terminal	<a href="#">247</a>
Straight, Bulkhead, Cable Connectors	<a href="#">246</a>
Straight, PCB Mount	<a href="#">246</a>
Straight, Press-In, Shroud	<a href="#">247</a>
Straight, Solder, Shroud	<a href="#">247</a>
Straight, Solder, Terminal	<a href="#">247</a>
Straight, Terminal	<a href="#">246</a>
Straight, Thread-In, Shroud	<a href="#">247</a>
Straight, Thread-In, Terminal	<a href="#">247</a>
<b>SSMA Female Connectors</b>	
Right Angle, PCB Mount	<a href="#">249</a>
Straight, 2 Hole Flange, Cable Connectors	<a href="#">249</a>
Straight, 2 Hole Flange, Terminal	<a href="#">249</a>
Straight, 4 Hole Flange, Cable Connectors	<a href="#">249</a>
Straight, 4 Hole Flange, Terminal	<a href="#">249</a>
Straight, Bulkhead, Cable Connectors	<a href="#">249</a>
Straight, Bulkhead, PCB Mount	<a href="#">249</a>
Straight, Bulkhead, Terminal	<a href="#">249</a>
Straight, Cable Connectors	<a href="#">248</a>
Straight, PCB Mount	<a href="#">249</a>

Connector Type	Page
<b>SSMA Male Connectors</b>	
Right Angle, Cable Connectors	<a href="#">248</a>
Straight, 2 Hole Flange, Terminal	<a href="#">248</a>
Straight, 4 Hole Flange, Terminal	<a href="#">248</a>
Straight, Cable Connectors	<a href="#">248</a>
Straight, PCB Mount	<a href="#">248</a>
<b>SSMB Jack Connectors</b>	
Right Angle, PCB Mount	<a href="#">250</a>
Straight, 4 Hole Flange, Terminal	<a href="#">250</a>
Straight, Bulkhead, Cable Connectors	<a href="#">250</a>
Straight, Bulkhead, Terminal	<a href="#">250</a>
Straight, PCB Mount	<a href="#">250</a>
<b>SSMB Plug Connectors</b>	
Right Angle, Cable Connectors	<a href="#">250</a>
Straight, Cable Connectors	<a href="#">249</a>
<b>SSMC Jack Connectors</b>	
Right Angle, Bulkhead, Cable Connectors	<a href="#">251</a>
Right Angle, Bulkhead, PCB Mount	<a href="#">251</a>
Right Angle, Bulkhead, Terminal	<a href="#">251</a>
Right Angle, PCB Mount	<a href="#">251</a>
Straight, 2 Hole Flange, Terminal	<a href="#">251</a>
Straight, 4 Hole Flange, Terminal	<a href="#">251</a>
Straight, Bulkhead, Cable Connectors	<a href="#">250</a>
Straight, Bulkhead, Terminal	<a href="#">251</a>
Straight, PCB Mount	<a href="#">250</a>
<b>SSMC Plug Connectors</b>	
Right Angle, Cable Connectors	<a href="#">250</a>
Right Angle, PCB Mount	<a href="#">250</a>
Straight, Cable Connectors	<a href="#">250</a>
<b>TNC Female Connectors</b>	
Right Angle, Bulkhead, Cable Connectors	<a href="#">254</a>
Right Angle, Bulkhead, PCB Mount	<a href="#">254</a>
Right Angle, Bulkhead, Terminal	<a href="#">254</a>
Right Angle, PCB Mount	<a href="#">254</a>
Straight, 4 Hole Flange, Cable Connectors	<a href="#">253</a>
Straight, 4 Hole Flange, Terminal	<a href="#">254</a>
Straight, Bulkhead, Cable Connectors	<a href="#">253</a>
Straight, Bulkhead, PCB Mount	<a href="#">253</a>
Straight, Bulkhead, Terminal	<a href="#">253</a>
Straight, Cable Connectors	<a href="#">252</a>
<b>TNC Male Connectors</b>	
Right Angle, Cable Connectors	<a href="#">252</a>
Straight, 4 Hole Flange, Terminal	<a href="#">252</a>
Straight, Cable Connectors	<a href="#">251</a>
<b>UHF Female Connectors</b>	
Straight, 4 Hole Flange, Terminal	<a href="#">256</a>
Straight, Bulkhead, Terminal	<a href="#">256</a>
Straight, Cable Connectors	<a href="#">256</a>
<b>UHF Male Connectors</b>	
Straight, Cable Connectors	<a href="#">256</a>
<b>UHF Sexless Connectors</b>	
Straight, Cable Connectors	<a href="#">256</a>
<b>UMCX Jack Connectors</b>	
Straight, PCB Mount	<a href="#">256</a>



### 1.0/2.3 Connectors

Connection Method	Product Image	Attachment Cable/Contact	Coax Type / Termination Type	Model No.	PRICE				ROW
					1-24	25-49	50-99	100 +	
<b>Plug</b>									
Cable Connectors		Crimp/Solder	RG55, RG142, RG223, RG400	<a href="#">PE44242</a>	\$12.79	\$12.15	\$11.51	\$11.00	1
			RG58, RG303, RG141, PE-C195, PE-P195, LMR-195, .195 inch	<a href="#">PE44243</a>	\$14.72	\$13.98	\$13.25	\$12.66	2
			RG174, RG316, RG188, LMR-100, PE-B100, PE-C100, .100 inch	<a href="#">PE44244</a>	\$14.03	\$13.33	\$12.63	\$12.07	3
			RG188-DS, RG316-DS	<a href="#">PE45166</a>	\$11.58	\$11.00	\$10.42	\$9.96	4
<b>Plug Right Angle</b>									
Cable Connectors		Crimp/Solder	RG55, RG142, RG223, RG400	<a href="#">PE44247</a>	\$15.03	\$14.28	\$13.53	\$12.93	5
			RG58, RG303, RG141, PE-C195, PE-P195, LMR-195, .195 inch	<a href="#">PE44248</a>	\$16.57	\$15.74	\$14.91	\$14.25	6
			RG174, RG316, RG188, LMR-100, PE-B100, PE-C100, .100 inch	<a href="#">PE44249</a>	\$14.28	\$13.57	\$12.85	\$12.28	7
			RG316-DS, RG188-DS	<a href="#">PE44783</a>	\$16.14	\$15.33	\$14.53	\$13.88	8
<b>Jack</b>									
PCB Mount		Solder	Thru Hole with .200 inch x .055 inch Hole Spacing	<a href="#">PE44257</a>	\$10.20	\$9.69	\$9.18	\$8.77	9
<b>Jack, Bulkhead Mount</b>									
Cable Connectors		Crimp/Solder	.100 inch, RG316, RG174, RG188, LMR-100, LMR-100A, LMR-100A-FR, PE-C100, PE-B100 with .217 inch DD Hole	<a href="#">PE44254</a>	\$16.46	\$15.64	\$14.81	\$14.16	10
		Solder/Solder	PE-SR402AL, PE-SR402FL, RG402 with .235 inch D Hole	<a href="#">PE44255</a>	\$21.53	\$20.45	\$19.38	\$18.52	11
		Solder/Solder	PE-SR405AL, PE-SR405FL, RG405 with .235 inch D Hole	<a href="#">PE44256</a>	\$18.23	\$17.32	\$16.41	\$15.68	12
PCB Mount		Solder	Thru Hole with .220 inch Diameter	<a href="#">PE44259</a>	\$12.59	\$11.96	\$11.33	\$10.83	13
<b>Jack Right Angle</b>									
PCB Mount		Solder	Thru Hole with .200 inch x .055 inch Hole Spacing	<a href="#">PE44258</a>	\$12.84	\$12.20	\$11.56	\$11.04	14
<b>Jack Right Angle, Bulkhead Mount</b>									
Cable Connectors		Crimp/Solder	RG58 with .236 inch DD Hole	<a href="#">PE44260</a>	\$15.74	\$14.95	\$14.17	\$13.54	15
			RG174, RG316, RG188 with .236 inch DD Hole	<a href="#">PE44261</a>	\$15.74	\$14.95	\$14.17	\$13.54	16

### 1.0mm Connectors





Connection Method	Product Image	Attachment Cable/Contact	Coax Type / Termination Type	Model No.	PRICE				ROW
					1-1	2-4	5-9	10 +	
<b>Female</b>									
PCB Mount		Clamp/Solder (Captive Contact)	End Launch	<a href="#">PE45403</a>	\$1,078.76	\$1,041.00	\$1,003.25	\$970.88	17

### 1.85mm Connectors









Connection Method	Product Image	Attachment Cable/Contact	Coax Type / Termination Type	Model No.	PRICE				ROW
					1 Pc.	See Web for Volume Pricing			
<b>Male</b>									
Cable Connectors		Clamp/Solder	PE-047SR, PE-SR047AL, PE-SR047FL	<a href="#">PE44799</a>	\$122.04	See Web for Volume Pricing			18
			PE-P086, PE-P086LL	<a href="#">PE45005</a>	\$89.47				19
PCB Mount		Clamp/Solder (Captive Contact)	End Launch	<a href="#">PE45517</a>	\$290.18				20
			End Launch	<a href="#">PE45518</a>	\$273.93				21

\* Fits MIL-C-17 and equivalent cable versions only

## 1.85mm Connectors

Connection Method	Product Image	Attachment Cable/Contact	Coax Type / Termination Type	Model No.	PRICE			ROW
					1 Pc.	See Web for Volume Pricing		
Cable Connectors		Solder	PE-SR405AL, PE-SR405FL, PE-SR405FLJ, PE-SR405TN, RG405	<a href="#">PE44336</a>	\$151.23			22
			PE-047SR, PE-SR047AL, PE-SR047FL	<a href="#">PE45410</a>	\$89.31			23
			PE-SR405AL, RG405, PE-SR405FLJ	<a href="#">PE45413</a>	\$92.79			24
			PECX001, PECX002	<a href="#">PE45482</a>	\$113.51			25
			PECX003, PECX004	<a href="#">PE45484</a>	\$113.51			26
<b>Female</b>								
Cable Connectors		Clamp/Solder	PE-047SR, PE-SR047AL, PE-SR047FL	<a href="#">PE44800</a>	\$137.81		See Web for Volume Pricing	27
PCB Mount		Clamp/Solder (Captive Contact)	End Launch	<a href="#">PE45402</a>	\$236.94			28
			End Launch	<a href="#">PE45477</a>	\$173.53			29
			End Launch	<a href="#">PE45515</a>	\$258.93			30
			End Launch	<a href="#">PE45516</a>	\$253.57		31	
<b>Female, Bulkhead Mount</b>								
Cable Connectors		Clamp/Solder	PE-SR405AL, PE-SR405FL, PE-SR405FLJ, PE-SR405TN, RG405 with .252 inch D Hole	<a href="#">PE44802</a>	\$130.43			32

## 2.4mm Connectors

Connection Method	Product Image	Attachment Cable/Contact	Coax Type / Termination Type	Model No.	PRICE			ROW
					1 Pc.	See Web for Volume Pricing		
<b>Male</b>								
PCB Mount		Clamp	Vertical Launch	<a href="#">PE45456</a>	\$47.61			33
			Vertical Launch	<a href="#">PE45457</a>	\$47.61			34
Cable Connectors		Clamp/Solder	PE-SR405AL, PE-SR405FL, PE-SR405FLJ, PE-SR405TN, RG405	<a href="#">PE44345</a>	Call		See Web for Volume Pricing	35
PCB Mount		Clamp/Solder (Captive Contact)	End Launch	<a href="#">PE45513</a>	\$212.14			36
			End Launch	<a href="#">PE45514</a>	\$175.36			37
Cable Connectors		Solder	PE-SR405AL, PE-SR405FL, RG405	<a href="#">PE44215</a>	\$65.23			38
			PE-047SR, PE-SR047AL, PE-SR047FL	<a href="#">PE45411</a>	\$85.06		39	
			PE-SR405AL, RG405, PE-SR405FLJ	<a href="#">PE45414</a>	\$85.06		40	
<b>Male, 2 Hole Flange Mount</b>								
Terminal		Solder	Pin with .481 inch Hole Spacing	<a href="#">PE44220</a>	\$161.80			41
<b>Female</b>								
PCB Mount		Clamp	Vertical Launch	<a href="#">PE45454</a>	\$44.50			42
			Vertical Launch	<a href="#">PE45455</a>	\$44.50			43
Cable Connectors		Clamp/Solder	PE-SR405AL, PE-SR405FL, PE-SR405FLJ, PE-SR405TN, RG405	<a href="#">PE44216</a>	\$190.20		See Web for Volume Pricing	44
PCB Mount		Clamp/Solder (Captive Contact)	End Launch	<a href="#">PE45401</a>	\$176.47			45
			End Launch	<a href="#">PE45472</a>	\$94.53			46
			End Launch	<a href="#">PE45473</a>	\$90.98			47
			End Launch	<a href="#">PE45474</a>	\$90.98			48
			End Launch	<a href="#">PE45475</a>	\$90.98			49
			End Launch	<a href="#">PE45476</a>	\$94.53			50
End Launch	<a href="#">PE45511</a>	\$191.48		51				
End Launch	<a href="#">PE45512</a>	\$216.79		52				
<b>Female, Bulkhead Mount</b>								
Cable Connectors		Clamp/Solder	PE-SR405AL, PE-SR405FL, PE-SR405FLJ, PE-SR405TN, RG405 with .252 inch D Hole	<a href="#">PE44801</a>	\$137.81			53

\* Fits MIL-C-17 and equivalent cable versions only











Connectors

See Our Website For Current Pricing & Real-Time Stock Availability!

## 2.4mm Connectors

Connection Method	Product Image	Attachment Cable/Contact	Coax Type / Termination Type	Model No.	PRICE			ROW
					1 Pc.	See Web for Volume Pricing		
<b>Female, 4 Hole Flange Mount</b>								
Terminal		Solder	Pin with .340 inch Hole Spacing	<a href="#">PE44218</a>	\$145.48			54

## 2.92mm Connectors



Connection Method	Product Image	Attachment Cable/Contact	Coax Type / Termination Type	Model No.	PRICE			ROW
					1 Pc.	See Web for Volume Pricing		
<b>Male</b>								
PCB Mount		Clamp	Vertical Launch	<a href="#">PE45452</a>	\$44.37	See Web for Volume Pricing		55
			Vertical Launch	<a href="#">PE45453</a>	\$44.37			56
Cable Connectors		Clamp/Solder	PE-SR405AL, PE-SR405FL, PE-SR405FLJ, PE-SR405TN, RG405	<a href="#">PE44796</a>	\$67.38			57
			PE-SR047FL, PE-SR047AL, PE-047SR	<a href="#">PE44797</a>	\$111.40			58
PCB Mount		Clamp/Solder (Captive Contact)	End Launch	<a href="#">PE45509</a>	\$185.91			59
			End Launch	<a href="#">PE45510</a>	\$175.36			60
Cable Connectors		Solder	PE-047SR, PE-SR047AL, PE-SR047FL	<a href="#">PE45412</a>	\$77.34			61
			PE-SR405AL, RG405, PE-SR405FLJ	<a href="#">PE45415</a>	\$77.34			62
			PECX001, PECX002	<a href="#">PE45483</a>	\$106.07	63		
			PECX005, PECX006	<a href="#">PE45485</a>	\$106.07	64		
			PE-118SR, 0.118 inch	<a href="#">PE45486</a>	\$110.21	65		
			PE-120SRLL, Tinned 120LL	<a href="#">PE45487</a>	\$106.07	66		
			PE-SR402AL, PE-SR402FL, PE-SR402FLJ, PE-SR402TN, RG402	<a href="#">PE4987</a>	\$50.39	67		
			PE-SR405AL, PE-SR405FL, RG405	<a href="#">PE4988</a>	\$48.76	68		
<b>Male, 2 Hole Flange Mount</b>								
Field Replaceable		Field Replaceable	.012 inch Pin with .481 inch Hole Spacing	<a href="#">PE44232</a>	\$70.30			69
<b>Female</b>								
PCB Mount		Clamp	Vertical Launch	<a href="#">PE45450</a>	\$41.46	See Web for Volume Pricing		70
			Vertical Launch	<a href="#">PE45451</a>	\$41.46			71
Cable Connectors		Clamp/Solder	PE-SR402AL, PE-SR402FL, RG402	<a href="#">PE44227</a>	\$125.89			72
			PE-047SR, PE-SR047AL, PE-SR047FL	<a href="#">PE44798</a>	\$126.64			73
PCB Mount		Clamp/Solder (Captive Contact)	End Launch	<a href="#">PE45400</a>	\$156.64			74
			End Launch	<a href="#">PE45467</a>	\$69.97			75
			End Launch	<a href="#">PE45468</a>	\$69.97			76
			End Launch	<a href="#">PE45469</a>	\$69.97			77
			End Launch	<a href="#">PE45470</a>	\$69.97	78		
			End Launch	<a href="#">PE45471</a>	\$67.34	79		
			End Launch	<a href="#">PE45507</a>	\$169.21	80		
End Launch	<a href="#">PE45508</a>	\$159.64	81					
<b>Female, Bulkhead Mount</b>								
Cable Connectors		Clamp/Solder	PE-SR405AL, PE-SR405FL, PE-SR405FLJ, PE-SR405TN, RG405 with .235 inch D Hole	<a href="#">PE4992</a>	\$161.80			82
<b>Female, 2 Hole Flange Mount</b>								
Field Replaceable		Field Replaceable	.012 inch Pin with .481 inch Hole Spacing	<a href="#">PE44229</a>	\$133.55			83

Connectors

See Our Website For Current Pricing & Real-Time Stock Availability!

\* Fits MIL-C-17 and equivalent cable versions only



### 3.5mm Connectors

Connection Method	Product Image	Attachment Cable/Contact	Coax Type / Termination Type	Model No.	PRICE				ROW
					1 Pc.	See Web for Volume Pricing			
<b>Male</b>									
Cable Connectors		Threaded	VNA Test Cable	<a href="#">PE44487</a>	\$686.25	See Web for Volume Pricing			84
					Clamp/Solder				
	PE-SR405AL, PE-SR405FL, PE-SR405FLJ, PE-SR405TN, RG405	<a href="#">PE4982</a>	\$99.61	86					
<b>Female</b>									
Cable Connectors		Clamp/Solder	PE-SR402AL, PE-SR402FL, PE-SR402FLJ, PE-SR402TN, RG402	<a href="#">PE45011</a>	\$97.48				87
<b>Female, Bulkhead Mount</b>									
Cable Connectors		Clamp/Solder	PE-SR402AL, PE-SR402FL, RG402 with .235 inch D Hole	<a href="#">PE4985</a>	\$272.81				88

### 7mm Connectors

Connection Method	Product Image	Attachment Cable/Contact	Coax Type / Termination Type	Model No.	PRICE				ROW
					1-9	10-24	25-49	50 +	
<b>Sexless</b>									
Cable Connectors		Threaded	VNA Test Cable	<a href="#">PE44484</a>	\$450.42	\$427.90	\$405.38	\$387.36	89

### 4.1/9.5 Mini DIN Connectors

Connection Method	Product Image	Attachment Cable/Contact	Coax Type / Termination Type	Model No.	PRICE				ROW
					1-24	25-49	50-99	100 +	
<b>Male</b>									
Cable Connectors		Solder/Solder	SPP-250-LLPL	<a href="#">PE45421</a>	\$27.80	\$26.41	\$25.02	\$23.91	90
<b>Male Right Angle</b>									
Cable Connectors		Solder/Solder	SPP-250-LLPL	<a href="#">PE45422</a>	\$38.22	\$36.31	\$34.40	\$32.87	91
			SPP-250-LLPL	<a href="#">TC-SPP250-4195M-RALP</a>	\$18.40	\$18.40	\$18.40	\$18.40	92
<b>Female</b>									
Cable Connectors		Solder/Solder	SPP-250-LLPL	<a href="#">PE45420</a>	\$31.26	\$29.70	\$28.13	\$26.88	93

### 4.3-10 Connectors







Connection Method	Product Image	Attachment Cable/Contact	Coax Type / Termination Type	Model No.	PRICE				ROW
					1-24	25-49	50-99	100 +	
<b>Male</b>									
Cable Connectors		Crimp/Solder	LMR-240	<a href="#">TC-240-4310M-X</a>	\$19.54	\$19.54	\$19.54	\$19.54	94
			LMR-400	<a href="#">TC-400-4310M-X</a>	\$20.08	\$20.08	\$20.08	\$20.08	95
			LMR-600	<a href="#">TC-600-4310M-X</a>	\$21.71	\$21.71	\$21.71	\$21.71	96
	Clamp/Solder	RG213, RG8, RG225, RG214, RG393	<a href="#">PE45295</a>	\$43.27	\$41.11	\$38.94	\$37.21	97	
		RG213, RG8, RG225, RG214, RG393	<a href="#">PE45296</a>	\$66.39	\$63.07	\$59.75	\$57.10	98	

\* Fits MIL-C-17 and equivalent cable versions only

Connectors

See Our Website For Current Pricing & Real-Time Stock Availability!

## 4.3-10 Connectors

Connection Method	Product Image	Attachment Cable/Contact	Coax Type / Termination Type	Model No.	PRICE				ROW
					1-24	25-49	50-99	100 +	
<b>Male</b>									
Cable Connectors		Solder/Solder	PE-1/4SFHC	<a href="#">PE45297</a>	\$40.90	\$38.86	\$36.81	\$35.17	99
			PE-1/4SFHC	<a href="#">PE45298</a>	\$17.30	\$16.44	\$15.57	\$14.88	1
			PE-1/2SFHC	<a href="#">PE45299</a>	\$17.54	\$16.66	\$15.79	\$15.08	2
			PE-1/2SFHC	<a href="#">PE45300</a>	\$29.63	\$28.15	\$26.67	\$25.48	3
			RG402, PE-SR402AL, PE-SR402FL, PE-SR402FLJ	<a href="#">PE45301</a>	\$30.29	\$28.78	\$27.26	\$26.05	4
			SPP-250-LLPL	<a href="#">PE45418</a>	\$27.80	\$26.41	\$25.02	\$23.91	5
			SPO-375, SPF-375, SPP-375-LLPL	<a href="#">TC-SPO375-4310M-LP</a>	\$18.40	\$18.40	\$18.40	\$18.40	6
	SPP-250-LLPL	<a href="#">TC-SPP250-4310MS-LP</a>	\$17.25	\$17.25	\$17.25	\$17.25	7		
		Crimp/Non-Solder Contact	LMR-240	<a href="#">EZ-240-4310M-X</a>	\$19.54	\$19.54	\$19.54	\$19.54	8
<b>Male Right Angle</b>									
Cable Connectors		Solder/Solder	PE-1/2SFHC	<a href="#">PE45302</a>	\$47.46	\$45.09	\$42.71	\$40.82	9
			RG402, PE-SR402AL, PE-SR402FL, PE-SR402FLJ	<a href="#">PE45303</a>	\$52.91	\$50.26	\$47.62	\$45.50	10
			SPP-250-LLPL	<a href="#">PE45419</a>	\$38.22	\$36.31	\$34.40	\$32.87	11
			SPP-250-LLPL, SPO-250, SPF-250	<a href="#">TC-250-4310M-RA-LP</a>	\$18.40	\$18.40	\$18.40	\$18.40	12
<b>Female</b>									
Cable Connectors		Solder/Solder	SPP-250-LLPL	<a href="#">PE45417</a>	\$31.26	\$29.70	\$28.13	\$26.88	13
			SPP-250-LLPL, SPO-250, SPF-250	<a href="#">TC-SPP250-4310F-LP</a>	\$17.25	\$17.25	\$17.25	\$17.25	14
<b>Female, 4 Hole Flange Mount</b>									
Cable Connectors		Solder/Solder	RG402, PE-SR402AL, PE-SR402FL, PE-SR402FLJ	<a href="#">PE45304</a>	\$25.13	\$23.87	\$22.62	\$21.61	15
Terminal		Solder	Solder Cup	<a href="#">PE45306</a>	\$19.24	\$18.28	\$17.32	\$16.55	16

Connectors













See Our Website For Current Pricing & Real-Time Stock Availability!

## 7/16 DIN Connectors

Connection Method	Product Image	Attachment Cable/Contact	Coax Type / Termination Type	Model No.	PRICE		ROW
					1 Pc.	See Web for Volume Pricing	
<b>Male</b>							
Cable Connectors		Crimp/Solder	PE-C195, PE-P195, RG58, RG141, RG303, LMR-195, .195 inch	<a href="#">PE44536</a>	\$39.63	See Web for Volume Pricing	17
			RG55, RG141, RG142, RG223, RG400	<a href="#">PE4568</a>	\$85.15		18
			RG58	<a href="#">PE4569</a>	\$99.09		19
			RG213, RG8	<a href="#">PE4570</a>	\$111.83		20
			RG214, RG9, RG225, RG393	<a href="#">PE4571</a>	\$55.39		21
			RG14, RG217	<a href="#">PE44276</a>	\$149.99		22
			RG17, RG218, RG219	<a href="#">PE44277</a>	\$164.54		23
			PE-SR401AL, PE-SR401FL, RG401	<a href="#">PE44278</a>	\$44.19		24
			7/8 inch Helical	<a href="#">PE44558</a>	\$88.50		25
			7/8 inch Annular	<a href="#">PE44568</a>	\$56.37		26
	7/8 inch Annular	<a href="#">PE44993</a>	\$46.12	27			
	RG58, RG55, RG141, RG142, RG223, RG400	<a href="#">PE45037</a>	\$112.87	28			
	RG393, RG214, RG225, RG215, RG8	<a href="#">PE4567</a>	\$41.53	29			
		Solder/Solder	SPP-250-LLPL	<a href="#">PE45424</a>	\$31.26	30	
		Clamp/Non-Solder Contact	LMR-SW396	<a href="#">EZ-SW396-716MC</a>	\$24.28	31	
			LMR-SW540	<a href="#">EZ-SW540-716MC</a>	\$22.20	32	
			1/4 inch Superflexible, PE-1/4SFHC	<a href="#">PE44728</a>	\$65.85	33	
			1/2 inch Helical, 1/2 inch Superflexible, PE-1/2 Helical, PE-1/2SFHC	<a href="#">PE44732</a>	\$45.09	34	

\* Fits MIL-C-17 and equivalent cable versions only

# 7/16 DIN Connectors

Connection Method	Product Image	Attachment Cable/Contact	Coax Type / Termination Type	Model No.	PRICE			ROW
					1 Pc.	See Web for Volume Pricing		
<b>Male</b>								
Cable Connectors		Clamp/Non-Solder Contact	1/2 inch Flexible, PE-1/2FAC	<a href="#">PE44738</a>	\$42.10			35
		Crimp/Non-Solder Contact	LMR-400, PE-C400, PE-B400, PE-B405	<a href="#">EZ-400-716M-X</a>	\$20.75	See Web for Volume Pricing		36
			LMR-600, PE-C600	<a href="#">EZ-600-716M-X</a>	\$25.25			37
			PE-C400, PE-B400, PE-B405, LMR-400, LMR-400-DB, LMR-400-UF, .400 inch	<a href="#">PE44538</a>	\$63.83			38
			PE-C240, RG8X, .240 inch, LMR-240, LMR-240-DB, LMR-240-UF, B7808A	<a href="#">PE44994</a>	\$43.47			39
LMR-600, PE-C600	<a href="#">PE45001</a>	\$60.91	40					
<b>Male Right Angle</b>								
Cable Connectors		Crimp/Solder	PE-C240, RG8X, .240 inch, LMR-240, LMR-240-DB, LMR-240-UF, B7808A	<a href="#">PE44541</a>	\$82.95	See Web for Volume Pricing		41
			PE-C400, PE-B400, PE-B405, LMR-400, LMR-400-DB, LMR-400-UF	<a href="#">PE44542</a>	\$67.73			42
			PE-C600, .600 inch	<a href="#">PE44543</a>	\$80.37			43
			LMR-195, LMR-195-FR, PE-C195, PE-P195	<a href="#">PE45046</a>	\$42.11			44
		Clamp/Solder	RG213, RG214, RG8, RG9, RG225, RG393, RG215	<a href="#">PE44280</a>	\$130.25			45
			RG14, RG217	<a href="#">PE44282</a>	\$217.76			46
		Solder/Solder	SPP-250-LLPL	<a href="#">PE45425</a>	\$45.15			47
			SPP-250-LLPL	<a href="#">TC-SPP250-716M-RA-LP</a>	\$18.40			48
		Clamp/Non-Solder Contact	1/2 inch Annular, 1/2 inch Flexible, PE-1/2FAC	<a href="#">PE44569</a>	\$48.94			49
			1/2 inch Helical	<a href="#">PE44979</a>	\$34.37			50
	Crimp/Non-Solder Contact	LMR-400, PE-C400, PE-B400, PE-B405	<a href="#">EZ-400-716M-RA-X</a>	\$23.00	51			
<b>Female</b>								
Cable Connectors		Crimp/Solder	RG213, RG8	<a href="#">PE44284</a>	\$124.34	See Web for Volume Pricing		52
			RG55, RG142, RG223, RG400	<a href="#">PE44286</a>	\$141.32			53
			RG58	<a href="#">PE44287</a>	\$100.97			54
			PE-C195, PE-P195, RG58, RG141, RG303, LMR-195, .195 inch	<a href="#">PE44544</a>	\$36.74			55
			PE-C400, PE-B400, PE-B405, LMR-400, LMR-400-DB, LMR-400-UF	<a href="#">PE44546</a>	\$72.30			56
			RG214, RG9, RG225, RG393	<a href="#">PE4575</a>	\$152.75			57
			RG213, RG55, RG141, RG142, RG223, RG400, RG303, PE-C195, PE-P195, LMR-195	<a href="#">PE44283</a>	\$151.23			58
		Clamp/Solder	RG58, RG55, RG141, RG142, RG223, RG400	<a href="#">PE44285</a>	\$136.02			59
			RG14, RG217	<a href="#">PE44288</a>	\$151.09			60
			PE-SR401AL, PE-SR401FL, RG401	<a href="#">PE44289</a>	\$114.10			61
			PE-SR402AL, PE-SR402FL, RG402	<a href="#">PE44290</a>	\$109.82			62
			1/2 inch Helical	<a href="#">PE44560</a>	\$40.38			63
		Solder/Solder	7/8 inch Helical	<a href="#">PE44561</a>	\$79.60			64
			SPP-250-LLPL	<a href="#">PE45423</a>	\$31.26			65
			SPP-250-LLPL	<a href="#">TC-SPP250-716F-LP</a>	\$13.80			66
		Clamp/Non-Solder Contact	SPP-375-LLPL, SPO-375, SPF-375	<a href="#">TC-SPP375-716F-LP</a>	\$13.80			67
			1/2 inch Superflexible, PE-1/2SFHC	<a href="#">PE44734</a>	\$45.09			68
	Crimp/Non-Solder Contact	1/2 inch Flexible, PE-1/2FAC	<a href="#">PE44740</a>	\$35.08	69			
		PE-C240, LMR-240, RG8X	<a href="#">PE44545</a>	\$60.13	70			
<b>Female, Bulkhead Mount</b>								
Cable Connectors		Crimp/Solder	.195 inch, RG58, RG141, RG303, LMR-195, LMR-195-FR, PE-C195, PE-P195 with 1.161 inch DD Hole	<a href="#">PE44548</a>	\$101.03			71
			PE-C240, RG8X, .240 inch, LMR-240, LMR-240-DB, LMR-240-UF, B7808A	<a href="#">PE44549</a>	\$74.96			72

\* Fits MIL-C-17 and equivalent cable versions only

Connectors

See Our Website For Current Pricing & Real-Time Stock Availability!



## 7/16 DIN Connectors



Connection Method	Product Image	Attachment Cable/Contact	Coax Type / Termination Type	Model No.	PRICE				ROW	
					1 Pc.	See Web for Volume Pricing				
<b>Female, Bulkhead Mount</b>										
Cable Connectors		Crimp/Solder	.400 inch, LMR-400, LMR-400-DB, LMR-400-UF, PE-B405, PE-C400, PE-B400 with 1.161 inch DD Hole	<a href="#">PE44550</a>	\$86.00	See Web for Volume Pricing				73
			PE-C600, LMR-600, LMR-600-DB, .600 inch with 1.161 inch DD Hole	<a href="#">PE44551</a>	\$104.69					74
			RG55, RG142, RG223, RG400 with 1.161 inch DD Hole	<a href="#">PE44656</a>	\$75.41					75
Terminal		Solder	Solder Cup	<a href="#">PE4572</a>	\$171.15					76
<b>Female, 4 Hole Flange Mount</b>										
Cable Connectors		Clamp/Solder	RG214, RG213, RG393, RG8, RG225, RG215, RG9 with .975 inch Hole Spacing	<a href="#">PE44291</a>	\$178.11	See Web for Volume Pricing				77
			RG14, RG217 with .975 inch Hole Spacing	<a href="#">PE44292</a>	\$187.11					78
Terminal		Solder	Stub	<a href="#">PE45000</a>	\$54.42	See Web for Volume Pricing				79
			Solder Cup with .975 inch Hole Spacing	<a href="#">PE4573</a>	\$99.10					80
		Field Replaceable	Slotted Contact	<a href="#">PE44717</a>	\$139.44					81
		Threaded Pin		Pin with .975 inch Hole Spacing	<a href="#">PE4574</a>					\$90.90
Pin with .975 inch Hole Spacing	<a href="#">PE4574A</a>			\$37.11	83					

## 10-32 Connectors











Connection Method	Product Image	Attachment Cable/Contact	Coax Type / Termination Type	Model No.	PRICE				ROW
					1-24	25-49	50-99	100 +	
<b>Male</b>									
Cable Connectors		Crimp/Solder	RG174, RG316, RG188, LMR-100, PE-B100, PE-C100, .100 inch	<a href="#">PE44351</a>	\$22.82	\$21.68	\$20.54	\$19.63	84
			RG178, RG196	<a href="#">PE44352</a>	\$37.37	\$35.50	\$33.63	\$32.14	85
			RG188-DS, RG316-DS	<a href="#">PE45170</a>	\$23.49	\$22.32	\$21.14	\$20.20	86
		Clamp/Solder	RG174, RG316, RG188, PE-B100, PE-C100, .100 inch, LMR-100	<a href="#">PE44353</a>	\$34.47	\$32.75	\$31.02	\$29.64	87
RG178, RG196	<a href="#">PE44354</a>		\$40.61	\$38.99	\$37.77	\$36.96	88		
<b>Male Right Angle</b>									
Cable Connectors		Crimp/Solder	RG174, RG316, RG188, PE-B100, PE-C100, .100 inch, LMR-100	<a href="#">PE44355</a>	\$24.86	\$23.62	\$22.37	\$21.38	89
			RG178, RG196	<a href="#">PE44356</a>	\$41.03	\$38.98	\$36.93	\$35.29	90
			RG316-DS, RG188-DS	<a href="#">PE45032</a>	\$25.12	\$23.86	\$22.61	\$21.60	91
<b>Female</b>									
Cable Connectors		Crimp/Solder	RG174, RG316, RG188, PE-B100, PE-C100, .100 inch, LMR-100	<a href="#">PE44361</a>	\$33.21	\$31.55	\$29.89	\$28.56	92
			RG178, RG196	<a href="#">PE44362</a>	\$31.58	\$30.32	\$29.37	\$28.74	93
			RG188-DS, RG316-DS	<a href="#">PE45171</a>	\$24.96	\$23.71	\$22.46	\$21.47	94
		Clamp/Solder	RG174, RG316, RG188, PE-B100, PE-C100, .100 inch, LMR-100	<a href="#">PE44363</a>	\$41.27	\$39.21	\$37.14	\$35.49	95
RG178, RG196	<a href="#">PE44364</a>		\$34.78	\$33.04	\$31.30	\$29.91	96		
PCB Mount		Solder	Thru Hole with .200 inch x .067 inch Hole Spacing	<a href="#">PE44359</a>	\$25.00	\$23.75	\$22.50	\$21.50	97
<b>Female, Bulkhead Mount</b>									
Cable Connectors		Crimp/Solder	RG174, RG316, RG188 with .295 inch D Hole	<a href="#">PE44365</a>	\$33.86	\$32.17	\$30.47	\$29.12	98
			RG178, RG196 with .295 inch D Hole	<a href="#">PE44366</a>	\$32.71	\$31.07	\$29.44	\$28.13	99
		Clamp/Solder	.100 inch, RG316, RG174, RG188, LMR-100, LMR-100A, LMR-100A-FR, PE-C100, PE-B100 with .295 inch D Hole	<a href="#">PE44367</a>	\$31.35	\$29.78	\$28.22	\$26.96	1
			RG178, RG196 with .295 inch D Hole	<a href="#">PE44368</a>	\$36.21	\$34.40	\$32.59	\$31.14	2

\* Fits MIL-C-17 and equivalent cable versions only

## 10-32 Connectors

Connection Method	Product Image	Attachment Cable/Contact	Coax Type / Termination Type	Model No.	PRICE				ROW
					1-24	25-49	50-99	100 +	
Terminal		Solder	Solder Cup with .177 inch D Hole	<a href="#">PE44357</a>	\$26.56	\$25.23	\$23.90	\$22.84	3
			Solder Cup with .295 inch D Hole	<a href="#">PE44358</a>	\$34.78	\$33.04	\$31.30	\$29.91	4
<b>Female Right Angle</b>									
PCB Mount		Solder	Thru Hole with .200 inch x .067 inch Hole Spacing	<a href="#">PE44360</a>	\$30.57	\$29.04	\$27.51	\$26.29	5

## BMA Connectors









Connection Method	Product Image	Attachment Cable/Contact	Coax Type / Termination Type	Model No.	PRICE				ROW
					1 Pc.	See Web for Volume Pricing			
<b>Plug</b>									
PCB Mount		Solder	Thru Hole	<a href="#">PE45335</a>	\$58.77				7
			Thru Hole	<a href="#">PE45336</a>	\$32.82				8
<b>Plug, Bulkhead Mount</b>									
Cable Connectors		Crimp/Solder	RG178, RG196	<a href="#">PE45315</a>	\$76.57	See Web for Volume Pricing			9
			RG316, RG188, RG174, PE-C100, LMR-100A	<a href="#">PE45316</a>	\$46.76				10
			RG188-DS, RG316-DS	<a href="#">PE45317</a>	\$34.40				11
			RG142, RG223, RG400, RG55	<a href="#">PE45318</a>	\$33.45				12
		Solder/Non-Solder Contact	RG405, PE-SR405AL, PE-SR405FL, PE-SR405FLJ, PE-SR405TN	<a href="#">PE45310</a>	\$35.86				13
			RG405, PE-SR405AL, PE-SR405FL, PE-SR405FLJ, PE-SR405TN	<a href="#">PE45311</a>	\$23.83				14
			RG402, PE-SR402AL, PE-SR402FL, PE-SR402FLJ, PE-SR402TN	<a href="#">PE45313</a>	\$56.70				15
			RG402, PE-SR402AL, PE-SR402FL, PE-SR402FLJ, PE-SR402TN	<a href="#">PE45314</a>	\$22.99				16
<b>Plug, 2 Hole Flange Mount</b>									
Terminal		Solder	Stub with .481 inch Hole Spacing	<a href="#">PE45341</a>	\$30.32	See Web for Volume Pricing			17
			Stub with .481 inch Hole Spacing	<a href="#">PE45342</a>	\$34.84				18
			Stub with .481 inch Hole Spacing	<a href="#">PE45343</a>	\$11.17				19
			Stub with .481 inch Hole Spacing	<a href="#">PE45344</a>	\$15.63				20
			Stub with .481 inch Hole Spacing	<a href="#">PE45347</a>	\$64.46				21
Field Replaceable		Field Replaceable	.012 inch Pin with .481 inch Hole Spacing	<a href="#">PE45345</a>	\$226.35	22			
			.020 inch Pin with .481 inch Hole Spacing	<a href="#">PE45346</a>	\$216.16	23			
			.036 inch Pin with .481 inch Hole Spacing	<a href="#">PE45348</a>	\$70.97	24			
<b>Plug, 4 Hole Flange Mount</b>									
Terminal		Solder	Stub with .340 inch Hole Spacing	<a href="#">PE45339</a>	\$35.37				25
<b>Plug, Thread-In</b>									
Terminal		None	Pin	<a href="#">PE45350</a>	\$104.84	See Web for Volume Pricing			26
			Pin	<a href="#">PE45351</a>	\$62.99				27
			Pin	<a href="#">PE45352</a>	\$119.74				28
			Pin	<a href="#">PE45353</a>	\$133.78				29
<b>Plug Right Angle</b>									
PCB Mount		Solder	Surface Mount	<a href="#">PE45333</a>	\$133.97				30
			Thru Hole	<a href="#">PE45355</a>	\$37.68				31
<b>Jack</b>									
Cable Connectors		Crimp/Solder	RG316, RG188, RG174, PE-C100, LMR-100A	<a href="#">PE45319</a>	\$76.69	See Web for Volume Pricing			32
			RG142, RG223, RG400, RG55	<a href="#">PE45320</a>	\$101.91				33
		Solder/Solder	RG405, PE-SR405AL, PE-SR405FL, PE-SR405FLJ	<a href="#">PE45324</a>	\$68.06				34
			RG405, PE-SR405AL, PE-SR405FL, PE-SR405FLJ	<a href="#">PE45325</a>	\$96.82				35

\* Fits MIL-C-17 and equivalent cable versions only

Connectors

See Our Website For Current Pricing & Real-Time Stock Availability!

## BMA Connectors

Connection Method	Product Image	Attachment Cable/Contact	Coax Type / Termination Type	Model No.	PRICE				ROW
					1 Pc.	See Web for Volume Pricing			
<b>Jack</b>									
Cable Connectors		Solder/Non-Solder Contact	RG402, PE-SR402AL, PE-SR402FL, PE-SR402FLJ, PE-SR402TN	<a href="#">PE45328</a>	\$76.04				36
PCB Mount		Solder	Thru Hole	<a href="#">PE45337</a>	\$50.86	See Web for Volume Pricing			37
			Surface Mount	<a href="#">PE45338</a>	\$56.90				38
Terminal			Stub	<a href="#">PE45349</a>	\$185.40				
<b>Jack, Bulkhead Mount</b>									
Cable Connectors		Solder/Solder	RG405, PE-SR405AL, PE-SR405FL, PE-SR405FLJ	<a href="#">PE45323</a>	\$43.74				40
<b>Jack, 2 Hole Flange Mount</b>									
Cable Connectors		Crimp/Solder	RG316, RG188, RG174, LMR-100A, PE-C100-LSZH	<a href="#">PE45321</a>	\$42.35	See Web for Volume Pricing			41
			RG402, PE-SR402AL, PE-SR402FL, PE-SR402FLJ, PE-SR402TN	<a href="#">PE45326</a>	\$56.64				42
	Solder/Solder	RG402, PE-SR402AL, PE-SR402FL, PE-SR402FLJ, PE-SR402TN	<a href="#">PE45327</a>	\$36.47	43				
		RG405, PE-SR405AL, PE-SR405FL, PE-SR405FLJ	<a href="#">PE45322</a>	\$49.49	44				
Terminal		Solder	Stub	<a href="#">PE45340</a>	\$58.87				45
<b>Jack, 4 Hole Flange Mount</b>									
Terminal		Solder	Stub with .340 inch Hole Spacing	<a href="#">PE45334</a>	\$54.24				46
<b>Jack, Thread-In</b>									
Terminal		None	Pin	<a href="#">PE45354</a>	\$60.77				47
<b>Jack Right Angle, 2 Hole Flange Mount</b>									
Cable Connectors		Crimp/Solder	RG142, RG223, RG400, RG55	<a href="#">PE45332</a>	\$55.56	See Web for Volume Pricing			48
			RG402, PE-SR402AL, PE-SR402FL, PE-SR402FLJ, PE-SR402TN	<a href="#">PE45329</a>	\$66.94				49
	Solder/Solder	RG405, PE-SR405AL, PE-SR405FL, PE-SR405FLJ	<a href="#">PE45330</a>	\$74.29	50				
		RG405, PE-SR405AL, PE-SR405FL, PE-SR405FLJ	<a href="#">PE45331</a>	\$61.38	51				

## BNC Connectors

Connection Method	Product Image	Attachment Cable/Contact	Coax Type / Termination Type	Model No.	PRICE				ROW
					1-24	25-49	50-99	100 +	
<b>Male</b>									
Cable Connectors		Crimp/Crimp	RG58, RG303, RG141, PE-C195, PE-P195, LMR-195, .195 inch	<a href="#">PE4016</a>	\$7.04	\$6.69	\$6.34	\$6.05	52
			RG59*, RG62*, RG71	<a href="#">PE4018</a>	\$9.58	\$9.10	\$8.62	\$8.24	53
			.100 inch, RG316, RG174, RG188, LMR-100, LMR-100, LMR-100-FR, PE-C100, PE-B100	<a href="#">PE45045</a>	\$7.30	\$6.94	\$6.57	\$6.28	54
			RG316-DS, RG188-DS	<a href="#">PE45114</a>	\$8.07	\$7.67	\$7.26	\$6.94	55
	Crimp/Solder	RG55, RG141, RG142, RG223, RG400	<a href="#">PE4044</a>	\$7.58	\$7.20	\$6.82	\$6.52	56	
		PE-B305	<a href="#">PE4210</a>	\$13.04	\$12.39	\$11.74	\$11.21	57	

\* Fits MIL-C-17 and equivalent cable versions only



Technical Support  
+1 (949) 261-1920











Same-Day Shipping,  
Even Custom  
Cable Assemblies

Connectors

See Our Website For Current Pricing & Real-Time Stock Availability!

# BNC Connectors

Connection Method	Product Image	Attachment Cable/Contact	Coax Type / Termination Type	Model No.	PRICE				ROW	
					1-24	25-49	50-99	100 +		
<b>Male</b>										
Cable Connectors		Crimp/Solder	PE-B150, RG180, RG195	<a href="#">PE4247</a>	\$13.58	\$12.90	\$12.22	\$11.68	58	
			RG214, RG9, RG225, RG393	<a href="#">PE4351</a>	\$22.73	\$21.59	\$20.46	\$19.55	59	
			RG213, RG215, RG8	<a href="#">PE4378</a>	\$25.30	\$24.04	\$22.77	\$21.76	60	
			RG58 Plenum, RG122, RG58-P	<a href="#">PE4381</a>	\$17.52	\$16.64	\$15.77	\$15.07	61	
			RG59* Plenum, RG59*-P, RG302	<a href="#">PE4382</a>	\$18.23	\$17.32	\$16.41	\$15.68	62	
			PE-C400, LMR-400	<a href="#">PE44294</a>	\$30.95	\$29.40	\$27.86	\$26.62	63	
			PE-C240, RG8X, .240 inch, LMR-240, LMR-240-DB, LMR-240-UF, B7808A	<a href="#">PE44640</a>	\$15.52	\$14.74	\$13.97	\$13.35	64	
			RG178, RG196	<a href="#">PE4643</a>	\$23.45	\$22.28	\$21.11	\$20.17	65	
			LMR-200, PE-C200	<a href="#">TC-200-BM-X</a>	\$13.75	\$13.75	\$13.75	\$13.75	66	
			LMR-240, PE-C240	<a href="#">TC-240-BM-X</a>	\$11.50	\$11.50	\$11.50	\$11.50	67	
	LMR-400, PE-C400	<a href="#">TC-400-BM-X</a>	\$13.87	\$13.87	\$13.87	\$13.87	68			
		Clamp/Solder	RG58, RG55, RG141, RG142, RG223, RG400, RG303, PE-C195, PE-P195, LMR-195	<a href="#">PE4023</a>	\$8.59	\$8.25	\$7.99	\$7.82	69	
			RG59*, RG62*, RG71	<a href="#">PE4024</a>	\$10.30	\$9.79	\$9.27	\$8.86	70	
			RG174, RG316, RG188, .100 inch, PE-B100, PE-C100, LMR-100	<a href="#">PE4084</a>	\$13.42	\$12.75	\$12.08	\$11.54	71	
			RG8, RG215, RG225, RG214, RG393, RG213	<a href="#">PE4109</a>	\$19.10	\$18.15	\$17.19	\$16.43	72	
			PE-SR402AL, PE-SR402FL, RG402	<a href="#">PE4206</a>	\$20.50	\$19.48	\$18.45	\$17.63	73	
			PE-SR405AL, PE-SR405FL, RG405	<a href="#">PE4207</a>	\$23.14	\$21.98	\$20.83	\$19.90	74	
			RG6	<a href="#">PE4377</a>	\$17.05	\$16.20	\$15.35	\$14.66	75	
			RG8X, PE-C240, .240 inch, B7808A, LMR-240	<a href="#">PE4379</a>	\$18.53	\$17.60	\$16.68	\$15.94	76	
			PE-SR401AL, PE-SR401FL, RG401	<a href="#">PE4380</a>	\$22.81	\$21.67	\$20.53	\$19.62	77	
			PE-B150, RG180, RG195	<a href="#">PE4383</a>	\$38.52	\$36.59	\$34.67	\$33.13	78	
		Solder/Solder	RG178, RG196	<a href="#">PE4384</a>	\$16.61	\$15.78	\$14.95	\$14.28	79	
			PE-B400, PE-B405, PE-C400, LMR-400, .400 inch	<a href="#">PE4386</a>	\$28.26	\$26.85	\$25.43	\$24.30	80	
			PE-C200	<a href="#">PE44040</a>	\$15.91	\$15.11	\$14.32	\$13.68	81	
			PE-C300	<a href="#">PE44042</a>	\$14.46	\$13.74	\$13.01	\$12.44	82	
			LMR-240, PE-C240	<a href="#">TC-240-BMC</a>	\$18.50	\$18.50	\$18.50	\$18.50	83	
			PE-SR402AL, PE-SR402FL, PE-SR402FLJ, PE-SR402TN, RG402	<a href="#">PE4650</a>	\$10.97	\$10.42	\$9.87	\$9.43	84	
			PE-SR405AL, PE-SR405FL, RG405	<a href="#">PE4651</a>	\$26.04	\$24.74	\$23.44	\$22.39	85	
			PE-SR401AL, PE-SR401FL, RG401	<a href="#">PE4908</a>	\$48.99	\$46.54	\$44.09	\$42.13	86	
			PE-047SR, PE-SR047AL, PE-SR047FL	<a href="#">PE4974</a>	\$39.67	\$37.69	\$35.70	\$34.12	87	
				Crimp/Non-Solder Contact	LMR-400, PE-C400, LMR-400-DB	<a href="#">EZ-400-BM-X</a>	\$15.50	\$15.50	\$15.50	\$15.50
	<b>Male, Bulkhead Mount</b>									
	Terminal		Solder	Solder Cup with .350 inch D Hole	<a href="#">PE4211</a>	\$16.05	\$15.25	\$14.45	\$13.80	89
	<b>Male, 4 Hole Flange Mount</b>									
	Terminal		Solder	Solder Cup with .531 inch Hole Spacing	<a href="#">PE4082</a>	\$17.92	\$17.02	\$16.13	\$15.41	90
	<b>Male Right Angle</b>									
	Cable Connectors		Crimp/Crimp	RG58, RG303, RG141, PE-C195, PE-P195, LMR-195, .195 inch	<a href="#">PE4298</a>	\$24.67	\$23.44	\$22.20	\$21.22	91
				RG59*, RG62*, RG71	<a href="#">PE4195</a>	\$25.84	\$24.55	\$23.26	\$22.22	92
		Crimp/Solder	RG55, RG141, RG142, RG223, RG400	<a href="#">PE4345</a>	\$10.95	\$10.40	\$9.86	\$9.42	93	
			RG174, RG316, RG188, .100 inch, PE-B100, PE-C100, LMR-100	<a href="#">PE4393</a>	\$25.90	\$24.61	\$23.31	\$22.27	94	
			RG188-DS, RG316-DS	<a href="#">PE4396</a>	\$29.40	\$27.93	\$26.46	\$25.28	95	
			PE-C240, RG8X, .240 inch, LMR-240, LMR-240-DB, LMR-240-UF, B7808A	<a href="#">PE44641</a>	\$26.25	\$24.94	\$23.63	\$22.58	96	
			PE-C200, LMR-200	<a href="#">PE44843</a>	\$20.59	\$19.56	\$18.53	\$17.71	97	
		Clamp/Solder	RG58, RG55, RG141, RG142, RG223, RG400, RG303, PE-C195, PE-P195, LMR-195	<a href="#">PE4053</a>	\$18.85	\$17.91	\$16.97	\$16.21	98	
			RG174, RG316, RG188, .100 inch, PE-B100, PE-C100, LMR-100	<a href="#">PE4307</a>	\$51.52	\$48.94	\$46.37	\$44.31	99	
			RG59*, RG62*	<a href="#">PE4320</a>	\$24.17	\$22.96	\$21.75	\$20.79	1	
		RG213, RG214, RG8, RG9, RG11*, RG225, RG393, RG144*, RG216*, RG215	<a href="#">PE4387</a>	\$37.28	\$35.42	\$33.55	\$32.06	2		

\* Fits MIL-C-17 and equivalent cable versions only

Connectors

See Our Website For Current Pricing & Real-Time Stock Availability!

# BNC Connectors







Connection Method	Product Image	Attachment Cable/Contact	Coax Type / Termination Type	Model No.	PRICE				ROW		
					1-24	25-49	50-99	100 +			
<b>Male Right Angle</b>											
Cable Connectors		Clamp/Solder	RG178, RG196	<a href="#">PE4388</a>	\$23.52	\$22.34	\$21.17	\$20.23	3		
		Solder/Solder	PE-SR402AL, PE-SR402FL, PE-SR402FLJ, PE-SR402TN, RG402	<a href="#">PE4092</a>	\$37.63	\$35.75	\$33.87	\$32.36	4		
			PE-SR405AL, PE-SR405FL, RG405	<a href="#">PE45239</a>	\$39.20	\$37.24	\$35.28	\$33.71	5		
<b>Female</b>											
Cable Connectors		Crimp/Solder	PE-C195, PE-P195, RG58, RG141, RG303, LMR-195, .195 inch	<a href="#">PE4070</a>	\$10.37	\$9.85	\$9.33	\$8.92	6		
			RG174, RG316, RG188, LMR-100, PE-B100, PE-C100, .100 inch	<a href="#">PE4079</a>	\$13.88	\$13.19	\$12.49	\$11.94	7		
			RG59*, RG62*, RG71	<a href="#">PE4308</a>	\$8.81	\$8.37	\$7.93	\$7.58	8		
			RG55, RG141, RG142, RG223, RG400	<a href="#">PE4397</a>	\$10.76	\$10.22	\$9.68	\$9.25	9		
			PE-C240, RG8X, .240 inch, LMR-240, LMR-240-DB, LMR-240-UF, B7808A	<a href="#">PE44642</a>	\$8.43	\$8.01	\$7.59	\$7.25	10		
			RG59*, RG62*, RG71	<a href="#">PE4057</a>	\$9.98	\$9.48	\$8.98	\$8.58	11		
			RG58, RG55, RG141, RG142, RG223, RG400, RG303, PE-C195, PE-P195, LMR-195	<a href="#">PE4058</a>	\$10.49	\$9.97	\$9.44	\$9.02	12		
			PE-SR402AL, PE-SR402FL, RG402	<a href="#">PE4204</a>	\$28.30	\$26.89	\$25.47	\$24.34	13		
			PE-SR405AL, PE-SR405FL, RG405	<a href="#">PE4205</a>	\$29.40	\$27.93	\$26.46	\$25.28	14		
			RG213, RG214, RG8, RG9, RG11*, RG225, RG393, RG144*, RG216*, RG215	<a href="#">PE4212</a>	\$45.63	\$43.35	\$41.07	\$39.24	15		
	RG174, RG316, RG188	<a href="#">PE4321</a>	\$13.89	\$13.20	\$12.50	\$11.95	16				
	RG178, RG196	<a href="#">PE4389</a>	\$18.82	\$17.88	\$16.94	\$16.19	17				
	PE-SR401AL, PE-SR401FL, RG401	<a href="#">PE44674</a>	\$30.92	\$29.37	\$27.83	\$26.59	18				
		Solder/Solder	PE-SR401FL, PE-SR401AL, RG401	<a href="#">PE45150</a>	\$30.59	\$29.06	\$27.53	\$26.31	19		
	PCB Mount		Solder	End Launch	<a href="#">PE44616</a>	\$13.38	\$12.71	\$12.04	\$11.51	20	
	<b>Female, Bulkhead Mount</b>										
	Cable Connectors		Crimp/Solder	RG58, PE-C195, PE-P195, LMR-195	<a href="#">PE45064</a>	\$14.75	\$14.01	\$13.28	\$12.69	21	
RG174, RG316, RG188, LMR-100, PE-B100, PE-C100, .100 inch with .480 inch D Hole				<a href="#">PE4106</a>	\$15.54	\$14.76	\$13.99	\$13.36	22		
RG58 with .480 inch D Hole				<a href="#">PE4208</a>	\$13.62	\$12.94	\$12.26	\$11.71	23		
RG55, RG142, RG223, RG400, RG141 with .480 inch D Hole				<a href="#">PE4209</a>	\$20.39	\$19.37	\$18.35	\$17.54	24		
RG59*, RG62*, RG71 with .480 inch D Hole				<a href="#">PE4309</a>	\$19.42	\$18.45	\$17.48	\$16.70	25		
RG188-DS, RG316-DS with .480 inch D Hole				<a href="#">PE4392</a>	\$19.17	\$18.21	\$17.25	\$16.49	26		
RG178, RG196 with .480 inch D Hole				<a href="#">PE44658</a>	\$21.48	\$20.41	\$19.33	\$18.47	27		
RG316, RG174, LMR-100				<a href="#">PE45131</a>	\$32.12	\$30.51	\$28.91	\$27.62	28		
		Clamp/Solder	RG58, RG142, RG223, RG400, RG141, RG303, RG55, LMR-400, PE-C195, PE-P195 with .480 inch D Hole	<a href="#">PE4078</a>	\$18.01	\$17.11	\$16.21	\$15.49	29		
			RG59*, RG62* with .480 inch D Hole	<a href="#">PE4310</a>	\$28.69	\$27.26	\$25.82	\$24.67	30		
			RG174, RG316, RG188 with .480 inch D Hole	<a href="#">PE4319</a>	\$17.30	\$16.44	\$15.57	\$14.88	31		
			RG178, RG196 with .480 inch D Hole	<a href="#">PE4391</a>	\$20.83	\$19.79	\$18.75	\$17.91	32		
			RG316-DS, RG188-DS	<a href="#">PE44886</a>	\$30.56	\$29.03	\$27.50	\$26.28	33		
			RG214, RG213, RG393, RG8, RG225, RG11*, RG216*, RG144*, RG215, RG9 with .480 inch D Hole	<a href="#">PE4632</a>	\$49.76	\$47.27	\$44.78	\$42.79	34		
			PE-SR402AL, PE-SR402FL, RG402	<a href="#">PE4915</a>	\$34.31	\$32.59	\$30.88	\$29.51	35		
			PE-SR405AL, PE-SR405FL, RG405	<a href="#">PE4916</a>	\$31.76	\$30.17	\$28.58	\$27.31	36		
				Solder	Solder Cup with .410 inch D Hole	<a href="#">PE4014</a>	\$7.53	\$7.15	\$6.78	\$6.48	37
					Solder Cup with .350 inch D Hole	<a href="#">PE4015</a>	\$8.28	\$7.87	\$7.45	\$7.12	38
Turret with .480 inch D Hole	<a href="#">PE4049</a>	\$18.53			\$17.60	\$16.68	\$15.94	39			
Spade with .350 inch D Hole	<a href="#">PE4077</a>	\$18.30			\$17.39	\$16.47	\$15.74	40			
Solder Cup with .350 inch D Hole	<a href="#">PE4091</a>	\$9.22			\$8.76	\$8.30	\$7.93	41			
Solder Cup with .480 inch D Hole	<a href="#">PE4318</a>	\$17.79			\$16.90	\$16.01	\$15.30	42			
PCB Mount			End Launch with .500 inch Diameter	<a href="#">PE44618</a>	\$19.98	\$18.98	\$17.98	\$17.18	43		

Connectors





See Our Website For Current Pricing & Real-Time Stock Availability!

\* Fits MIL-C-17 and equivalent cable versions only

## BNC Connectors

Connection Method	Product Image	Attachment Cable/Contact	Coax Type / Termination Type	Model No.	PRICE				ROW
					1-24	25-49	50-99	100 +	
<b>Female, Bulkhead Mount</b>									
Terminal		Solder	Eyelet	<a href="#">PE44890</a>	\$27.41	\$26.04	\$24.67	\$23.57	44
			Eyelet	<a href="#">PE44891</a>	\$93.45	\$88.78	\$84.11	\$80.37	45
<b>Female, 4 Hole Flange Mount</b>									
Cable Connectors		Clamp/Solder	RG58, RG142, RG223, RG400, RG141, RG303, RG55, LMR-400, PE-C195, PE-P195 with .500 inch Threaded Hole Spacing	<a href="#">PE4056</a>	\$17.95	\$17.05	\$16.16	\$15.44	46
			RG316-DS, RG188-DS	<a href="#">PE44887</a>	\$38.53	\$36.60	\$34.68	\$33.14	47
		Solder/Solder	PE-047SR, PE-SR047FL, PE-SR047AL	<a href="#">PE44888</a>	\$40.33	\$38.31	\$36.30	\$34.68	48
Terminal		Solder	Solder Cup with .500 inch Threaded Hole Spacing	<a href="#">PE4010</a>	\$9.51	\$9.03	\$8.56	\$8.18	49
			Turret with .531 inch Hole Spacing	<a href="#">PE4011</a>	\$20.55	\$19.52	\$18.50	\$17.67	50
			Solder Cup with .500 inch Hole Spacing	<a href="#">PE4394</a>	\$13.80	\$13.11	\$12.42	\$11.87	51
			Solder Cup with .718 inch Hole Spacing	<a href="#">PE4395</a>	\$24.22	\$23.01	\$21.80	\$20.83	52
		Field Replaceable	Slotted Contact	<a href="#">PE44720</a>	\$52.95	\$50.30	\$47.66	\$45.54	53
<b>Female Right Angle, Bulkhead Mount</b>									
Terminal		Solder	Solder Cup with .361 inch D Hole	<a href="#">PE4055</a>	\$27.49	\$26.12	\$24.74	\$23.64	54
<b>Female Right Angle, 4 Hole Flange Mount</b>									
Terminal		Solder	Solder Cup with .531 inch Hole Spacing	<a href="#">PE4317</a>	\$32.48	\$30.86	\$29.23	\$27.93	55

## Reverse Polarity BNC Connectors











Connection Method	Product Image	Attachment Cable/Contact	Coax Type / Termination Type	Model No.	PRICE				ROW
					1-24	25-49	50-99	100 +	
<b>Male</b>									
Cable Connectors		Crimp/Solder	RG213, RG8	<a href="#">PE4712</a>	\$29.35	\$27.88	\$26.42	\$25.24	56
			RG214, RG9, RG225, RG393	<a href="#">PE4713</a>	\$31.35	\$29.78	\$28.22	\$26.96	57
			RG55, RG141, RG142, RG223, RG400	<a href="#">PE4715</a>	\$14.89	\$14.15	\$13.40	\$12.81	58
			RG58, RG303, RG141, PE-C195, PE-P195, LMR-195, .195 inch	<a href="#">PE4716</a>	\$17.48	\$16.61	\$15.73	\$15.03	59
			RG59*, RG62*	<a href="#">PE4718</a>	\$16.57	\$15.74	\$14.91	\$14.25	60
			RG174, RG316, RG188, LMR-100, PE-B100, PE-C100, .100 inch	<a href="#">PE4720</a>	\$24.37	\$23.15	\$21.93	\$20.96	61
			RG213, RG214, RG8, RG9, RG225, RG393, RG215	<a href="#">PE4711</a>	\$36.57	\$34.74	\$32.91	\$31.45	62
		Clamp/Solder	RG58, RG55, RG141, RG142, RG223, RG400, RG303, PE-C195, PE-P195, LMR-195	<a href="#">PE4714</a>	\$36.24	\$34.43	\$32.62	\$31.17	63
			RG59*, RG62*	<a href="#">PE4717</a>	\$14.99	\$14.24	\$13.49	\$12.89	64
			RG174, RG316, RG188, LMR-100, PE-B100, PE-C100, .100 inch	<a href="#">PE4719</a>	\$36.57	\$34.74	\$32.91	\$31.45	65
			RG178, RG196	<a href="#">PE4721</a>	\$26.79	\$25.45	\$24.11	\$23.04	66
			PE-SR402AL, PE-SR402FL, RG402	<a href="#">PE4722</a>	\$22.98	\$21.83	\$20.68	\$19.76	67
			PE-B400, PE-B405	<a href="#">PE4726</a>	\$28.76	\$27.32	\$25.88	\$24.73	68
			<b>Male, 4 Hole Flange Mount</b>						
Terminal		Solder	Solder Cup with .531 inch Hole Spacing	<a href="#">PE4762</a>	\$24.13	\$22.92	\$21.72	\$20.75	69
<b>Male Right Angle</b>									
Cable Connectors		Crimp/Solder	RG55, RG141, RG142, RG223, RG400	<a href="#">PE4729</a>	\$24.82	\$23.58	\$22.34	\$21.35	70
			RG58, RG303, RG141, PE-C195, PE-P195, LMR-195, .195 inch	<a href="#">PE4730</a>	\$29.91	\$28.41	\$26.92	\$25.72	71
			RG174, RG316, RG188	<a href="#">PE4733</a>	\$24.37	\$23.15	\$21.93	\$20.96	72

\* Fits MIL-C-17 and equivalent cable versions only

Connectors

See Our Website For Current Pricing & Real-Time Stock Availability!

## Reverse Polarity BNC Connectors

Connection Method	Product Image	Attachment Cable/Contact	Coax Type / Termination Type	Model No.	PRICE				ROW			
					1-24	25-49	50-99	100 +				
<b>Male Right Angle</b>												
Cable Connectors		Clamp/Solder	RG213, RG214, RG8, RG9, RG225, RG393, RG215	<a href="#">PE4727</a>	\$45.31	\$43.04	\$40.78	\$38.97	73			
			RG58, RG55, RG141, RG142, RG223, RG400, RG303, PE-C195, PE-P195, LMR-195	<a href="#">PE4728</a>	\$25.17	\$23.91	\$22.65	\$21.65	74			
			RG59*, RG62*	<a href="#">PE4731</a>	\$30.17	\$28.66	\$27.15	\$25.95	75			
			RG174, RG316, RG188	<a href="#">PE4732</a>	\$25.78	\$24.49	\$23.20	\$22.17	76			
<b>Female</b>												
Cable Connectors		Crimp/Solder	RG188-DS, RG316-DS	<a href="#">PE45182</a>	\$22.20	\$21.09	\$19.98	\$19.09	77			
			RG55, RG141, RG142, RG223, RG400	<a href="#">PE4737</a>	\$22.29	\$21.18	\$20.06	\$19.17	78			
			RG58	<a href="#">PE4738</a>	\$26.34	\$25.02	\$23.71	\$22.65	79			
			RG59*, RG62*	<a href="#">PE4739</a>	\$24.37	\$23.15	\$21.93	\$20.96	80			
			RG174, RG316, RG188	<a href="#">PE4742</a>	\$26.34	\$25.02	\$23.71	\$22.65	81			
		Clamp/Solder	RG213, RG214, RG8, RG9, RG225, RG393	<a href="#">PE4735</a>	\$37.72	\$35.83	\$33.95	\$32.44	82			
			RG55, RG58, RG141, RG142, RG223, RG400	<a href="#">PE4736</a>	\$36.57	\$34.74	\$32.91	\$31.45	83			
			RG59*, RG62*, RG71	<a href="#">PE4740</a>	\$30.17	\$28.66	\$27.15	\$25.95	84			
			RG174, RG316, RG188	<a href="#">PE4741</a>	\$30.37	\$28.85	\$27.33	\$26.12	85			
			RG178, RG196	<a href="#">PE4743</a>	\$30.37	\$28.85	\$27.33	\$26.12	86			
			PE-SR402AL, PE-SR402FL, RG402	<a href="#">PE4744</a>	\$23.41	\$22.24	\$21.07	\$20.13	87			
			PE-SR405AL, PE-SR405FL, RG405	<a href="#">PE4745</a>	\$23.67	\$22.49	\$21.30	\$20.36	88			
			<b>Female, Bulkhead Mount</b>									
			Cable Connectors		Crimp/Solder	RG55, RG141, RG142, RG223, RG400 with .480 inch D Hole	<a href="#">PE4747</a>	\$25.29	\$24.03	\$22.76	\$21.75	89
RG58 with .480 inch D Hole	<a href="#">PE4748</a>	\$26.64				\$25.31	\$23.98	\$22.91	90			
.100 inch, RG316, RG174, RG188, LMR-100, LMR-100A, LMR-100A-FR, PE-C100, PE-B100 with .480 inch D Hole	<a href="#">PE4752</a>	\$27.69				\$26.31	\$24.92	\$23.81	91			
	Clamp/Solder	RG55, RG58, RG141, RG142, RG223, RG400 with .480 inch D Hole		<a href="#">PE4746</a>	\$38.33	\$36.41	\$34.50	\$32.96	92			
		RG59*, RG62* with .480 inch D Hole		<a href="#">PE4749</a>	\$34.27	\$32.56	\$30.84	\$29.47	93			
		RG174, RG316, RG188 with .480 inch D Hole		<a href="#">PE4751</a>	\$22.56	\$21.43	\$20.30	\$19.40	94			
Terminal		Solder	PE-SR405AL, PE-SR405FL, RG405 with .480 inch D Hole	<a href="#">PE4755</a>	\$25.78	\$24.49	\$23.20	\$22.17	95			
			Solder Cup with .410 inch D Hole	<a href="#">PE4757</a>	\$16.10	\$15.30	\$14.49	\$13.85	96			
			Solder Cup with .350 inch D Hole	<a href="#">PE4758</a>	\$14.63	\$13.90	\$13.17	\$12.58	97			
			Solder Cup with .480 inch D Hole	<a href="#">PE4764</a>	\$23.38	\$22.21	\$21.04	\$20.11	98			
<b>Female, 4 Hole Flange Mount</b>												
Cable Connectors		Clamp/Solder	RG55, RG58, RG141, RG142, RG223, RG400 with .500 inch Threaded Hole Spacing	<a href="#">PE4765</a>	\$30.17	\$28.66	\$27.15	\$25.95	99			
Terminal		Solder	Solder Cup with .500 inch Threaded Hole Spacing	<a href="#">PE4756</a>	\$25.32	\$24.05	\$22.79	\$21.78	1			
			Solder Cup with .500 inch Hole Spacing	<a href="#">PE4763</a>	\$25.33	\$24.06	\$22.80	\$21.78	2			
<b>Female Right Angle, Bulkhead Mount</b>												
Terminal		Solder	Solder Cup with .361 inch D Hole	<a href="#">PE4759</a>	\$45.28	\$43.02	\$40.75	\$38.94	3			
<b>Female Right Angle, 4 Hole Flange Mount</b>												
Terminal		Solder	Solder Cup with .531 inch Hole Spacing	<a href="#">PE4760</a>	\$43.15	\$40.99	\$38.84	\$37.11	4			

## C Connectors

Connection Method	Product Image	Attachment Cable/Contact	Coax Type / Termination Type	Model No.	PRICE				ROW
					1-24	25-49	50-99	100 +	
<b>Male</b>									
Cable Connectors		Crimp/Solder	RG214, RG9, RG225, RG393	<a href="#">PE4375</a>	\$27.18	\$25.82	\$24.46	\$23.37	5
			RG55, RG141, RG142, RG223, RG400	<a href="#">PE4445</a>	\$28.38	\$26.96	\$25.54	\$24.41	6
			RG58, RG303, RG141, PE-C195, PE-P195, LMR-195, .195 inch	<a href="#">PE4517</a>	\$37.78	\$35.89	\$34.00	\$32.49	7

\* Fits MIL-C-17 and equivalent cable versions only



Technical Support  
+1 (949) 261-1920













Same-Day Shipping,  
Even Custom  
Cable Assemblies

Connectors

See Our Website For Current Pricing & Real-Time Stock Availability!

# C Connectors

Connection Method	Product Image	Attachment Cable/Contact	Coax Type / Termination Type	Model No.	PRICE				ROW
					1-24	25-49	50-99	100 +	
<b>Male</b>									
Cable Connectors		Crimp/Solder	RG213, RG8	<a href="#">PE4518</a>	\$35.67	\$33.89	\$32.10	\$30.68	8
		Clamp/Solder	RG55, RG58, RG141, RG142, RG223, RG303, RG400, PE-C195, PE-P195, LMR-195	<a href="#">PE4242</a>	\$49.46	\$46.99	\$44.51	\$42.54	9
			RG213, RG214, RG8, RG9, RG11*, RG225, RG393, RG144*, RG216*, RG215	<a href="#">PE4243</a>	\$43.08	\$40.93	\$38.77	\$37.05	10
			RG213, RG214, RG8, RG9, RG11*, RG225, RG393, RG144*, RG216*, RG215	<a href="#">PE4950</a>	\$48.57	\$46.14	\$43.71	\$41.77	11
			RG14, RG217	<a href="#">PE4951</a>	\$55.99	\$53.19	\$50.39	\$48.15	12
			RG59*, RG62*, RG71	<a href="#">PE4952</a>	\$49.60	\$47.62	\$46.13	\$45.14	13
			RG174, RG316, RG188	<a href="#">PE4953</a>	\$35.67	\$33.89	\$32.10	\$30.68	14
RG218	<a href="#">PE4954</a>	\$89.84	\$85.35	\$80.86	\$77.26	15			
<b>Male, 4 Hole Flange Mount</b>									
Terminal		Solder	Solder Cup with .718 inch Hole Spacing	<a href="#">PE44096</a>	\$69.82	\$66.33	\$62.84	\$60.05	16
<b>Male Right Angle</b>									
Cable Connectors		Crimp/Solder	RG214, RG9, RG225, RG393	<a href="#">PE4949</a>	\$84.19	\$79.98	\$75.77	\$72.40	17
			RG213, RG8	<a href="#">PE4955</a>	\$72.23	\$68.62	\$65.01	\$62.12	18
			RG55, RG141, RG142, RG223, RG400	<a href="#">PE4958</a>	\$69.01	\$65.56	\$62.11	\$59.35	19
		Clamp/Solder	PE-P195, PE-C195, RG58, RG141, RG303, .195 inch, LMR-195	<a href="#">PE4959</a>	\$86.99	\$82.64	\$78.29	\$74.81	20
			RG213, RG214, RG8, RG9, RG11*, RG225, RG393, RG144*, RG216*, RG215	<a href="#">PE4244</a>	\$70.50	\$66.98	\$63.45	\$60.63	21
			RG55, RG58, RG141, RG142, RG223, RG303, RG400, PE-C195, PE-P195, LMR-195	<a href="#">PE4957</a>	\$90.20	\$85.69	\$81.18	\$77.57	22
<b>Female</b>									
Cable Connectors		Clamp/Solder	RG213, RG214, RG8, RG9, RG11*, RG225, RG393, RG144*, RG216*, RG215	<a href="#">PE4960</a>	\$55.79	\$53.00	\$50.21	\$47.98	23
			RG55, RG58, RG141, RG142, RG223, RG303, RG400, PE-C195, PE-P195, LMR-195	<a href="#">PE4961</a>	\$80.81	\$76.77	\$72.73	\$69.50	24
			RG59*, RG62*	<a href="#">PE4962</a>	\$38.01	\$36.11	\$34.21	\$32.69	25
			RG14, RG217	<a href="#">PE4963</a>	\$70.58	\$67.05	\$63.52	\$60.70	26
<b>Female, Bulkhead Mount</b>									
Cable Connectors		Clamp/Solder	RG59*, RG62* with .596 inch D Hole	<a href="#">PE44098</a>	\$31.53	\$29.95	\$28.38	\$27.12	27
			RG58, RG142, RG223, RG400, RG141, RG303, RG55, LMR-400, PE-C195, PE-P195 with .596 inch D Hole	<a href="#">PE44099</a>	\$70.65	\$67.12	\$63.59	\$60.76	28
			RG214, RG213, RG393, RG8, RG225, RG11*, RG216*, RG144*, RG215, RG9 with .720 inch D Hole	<a href="#">PE4964</a>	\$67.06	\$63.71	\$60.35	\$57.67	29
			RG58, RG55, RG141, RG142, RG223, RG400 with .720 inch D Hole	<a href="#">PE4965</a>	\$79.06	\$75.11	\$71.15	\$67.99	30
Terminal		Solder	Solder Cup with .720 inch D Hole	<a href="#">PE4240</a>	\$53.90	\$51.74	\$50.13	\$49.05	31
			Solder Cup with .720 inch D Hole	<a href="#">PE4971</a>	\$75.52	\$71.74	\$67.97	\$64.95	32
			Solder Cup with .720 inch D Hole	<a href="#">PE4972</a>	\$75.52	\$71.74	\$67.97	\$64.95	33
			Turret with .350 inch D Hole	<a href="#">PE4973</a>	\$79.33	\$75.36	\$71.40	\$68.22	34
<b>Female, 4 Hole Flange Mount</b>									
Cable Connectors		Crimp/Solder	RG214, RG9, RG225, RG393 with .718 inch Hole Spacing	<a href="#">PE4374</a>	\$67.28	\$63.92	\$60.55	\$57.86	35
			RG214, RG213, RG393, RG8, RG225, RG11*, RG216*, RG144*, RG215, RG9 with .718 inch Hole Spacing	<a href="#">PE4967</a>	\$80.07	\$76.07	\$72.06	\$68.86	36
		Clamp/Solder	RG58, RG142, RG223, RG400, RG141, RG303, RG55, LMR-400, PE-C195, PE-P195 with .718 inch Hole Spacing	<a href="#">PE4969</a>	\$58.37	\$55.45	\$52.53	\$50.20	37
			RG59*, RG62* with .718 inch Hole Spacing	<a href="#">PE4970</a>	\$67.93	\$64.53	\$61.14	\$58.42	38
			RG213, RG214, RG393, RG11*	<a href="#">PE4CO1013</a>	\$72.98	\$69.33	\$65.68	\$62.76	39
Terminal		Solder	Solder Cup with .718 inch Hole Spacing	<a href="#">PE4241</a>	\$22.08	\$20.98	\$19.87	\$18.99	40







\* Fits MIL-C-17 and equivalent cable versions only

Connectors



See Our Website For Current Pricing & Real-Time Stock Availability!



## D-Sub Connectors

Connection Method	Product Image	Attachment Cable/Contact	Coax Type / Termination Type	Model No.	PRICE				ROW
					1-24	25-49	50-99	100 +	
	<b>Plug</b>								
Cable Connectors		Crimp/Solder	PE-C195, PE-P195, RG58, RG141, RG303, LMR-195, .195 inch	<a href="#">PE4808</a>	\$15.50	\$14.73	\$13.95	\$13.33	41
			RG174, RG316, RG188, .100 inch, PE-B100, PE-C100, LMR-100	<a href="#">PE4809</a>	\$23.46	\$22.29	\$21.11	\$20.18	42
		Solder/Solder	RG58, RG141, RG303	<a href="#">PE4812</a>	\$12.76	\$12.12	\$11.48	\$10.97	43
			RG180, RG195, PE-B150	<a href="#">PE4815</a>	\$18.31	\$17.39	\$16.48	\$15.75	44
	<b>Plug Right Angle</b>								
Cable Connectors		Crimp/Solder	RG55, RG142, RG223, RG400	<a href="#">PE44035</a>	\$13.77	\$13.08	\$12.39	\$11.84	45
		Solder/Solder	PE-SR405AL, PE-SR405FL, RG405	<a href="#">PE44038</a>	\$20.91	\$20.07	\$19.45	\$19.03	46
	<b>Receptacle</b>								
Cable Connectors		Crimp/Solder	PE-C195, PE-P195, RG58, RG141, RG303, LMR-195, .195 inch	<a href="#">PE4800</a>	\$15.48	\$14.71	\$13.93	\$13.31	47
			RG174, RG316, RG188, .100 inch, PE-B100, PE-C100, LMR-100	<a href="#">PE4801</a>	\$17.03	\$16.18	\$15.33	\$14.65	48
		Solder/Solder	RG58, RG141, RG303	<a href="#">PE4804</a>	\$13.12	\$12.46	\$11.81	\$11.28	49
			RG180, RG195	<a href="#">PE4807</a>	\$8.19	\$7.78	\$7.37	\$7.04	50
	<b>Receptacle Right Angle</b>								
Cable Connectors		Crimp/Solder	RG58, RG141, RG303	<a href="#">PE4816</a>	\$25.68	\$24.65	\$23.88	\$23.37	51

## FAKRA Connectors

Connection Method	Product Image	Attachment Cable/Contact	Coax Type / Termination Type	Model No.	PRICE				ROW
					1-24	25-49	50-99	100 +	
	<b>Plug</b>								
Cable Connectors		Crimp/Solder	RG174, RG316, RG188, .100 inch, PE-B100, PE-C100, LMR-100 with Black Color	<a href="#">PE45404A</a>	\$5.38	\$5.11	\$4.84	\$4.63	52
			RG174, RG316, RG188, .100 inch, PE-B100, PE-C100, LMR-100 with White Color	<a href="#">PE45404B</a>	\$5.38	\$5.00	\$4.63	\$4.30	53
			RG174, RG316, RG188, .100 inch, PE-B100, PE-C100, LMR-100 with Blue Color	<a href="#">PE45404C</a>	\$5.38	\$5.11	\$4.84	\$4.63	54
			RG174, RG316, RG188, .100 inch, PE-B100, PE-C100, LMR-100 with Bordeaux Color	<a href="#">PE45404D</a>	\$5.38	\$5.11	\$4.84	\$4.63	55
			RG174, RG316, RG188, .100 inch, PE-B100, PE-C100, LMR-100 with Violet Color	<a href="#">PE45404H</a>	\$5.38	\$5.11	\$4.84	\$4.63	56
			RG174, RG316, RG188, .100 inch, PE-B100, PE-C100, LMR-100 with Beige Color	<a href="#">PE45404I</a>	\$5.38	\$5.11	\$4.84	\$4.63	57
			RG174, RG316, RG188, .100 inch, PE-B100, PE-C100, LMR-100 with Curry Color	<a href="#">PE45404K</a>	\$5.38	\$5.11	\$4.84	\$4.63	58
			RG174, RG316, RG188, .100 inch, PE-B100, PE-C100, LMR-100 with Water Blue Color	<a href="#">PE45404Z</a>	\$5.38	\$5.11	\$4.84	\$4.63	59
PCB Mount		Solder	Thru Hole with Black Color	<a href="#">PE44649A</a>	\$6.04	\$5.74	\$5.44	\$5.19	60
			Thru Hole with White Color	<a href="#">PE44649B</a>	\$2.96	\$2.81	\$2.66	\$2.55	61
			Thru Hole with Blue Color	<a href="#">PE44649C</a>	\$6.04	\$5.74	\$5.44	\$5.19	62
			Thru Hole with Bordeaux Color	<a href="#">PE44649D</a>	\$3.39	\$3.22	\$3.05	\$2.92	63
			Thru Hole with Violet Color	<a href="#">PE44649H</a>	\$2.96	\$2.81	\$2.66	\$2.55	64
			Thru Hole with Beige Color	<a href="#">PE44649I</a>	\$4.77	\$4.53	\$4.29	\$4.10	65
			Thru Hole with Curry Color	<a href="#">PE44649K</a>	\$2.96	\$2.81	\$2.66	\$2.55	66
			Thru Hole with Water Blue Color	<a href="#">PE44649Z</a>	\$6.23	\$5.92	\$5.61	\$5.36	67

\* Fits MIL-C-17 and equivalent cable versions only



Technical Support  
+1 (949) 261-1920







Same-Day Shipping,  
Even Custom  
Cable Assemblies



Connectors

See Our Website For Current Pricing & Real-Time Stock Availability!

# FAKRA Connectors

Connection Method	Product Image	Attachment Cable/Contact	Coax Type / Termination Type	Model No.	PRICE				ROW
					1-24	25-49	50-99	100 +	
<b>Plug Right Angle</b>									
PCB Mount		Solder	Thru Hole with Black Color	<a href="#">PE44651A</a>	\$8.46	\$8.04	\$7.61	\$7.28	68
			Thru Hole with White Color	<a href="#">PE44651B</a>	\$5.09	\$4.84	\$4.58	\$4.38	69
			Thru Hole with Blue Color	<a href="#">PE44651C</a>	\$8.46	\$8.04	\$7.61	\$7.28	70
			Thru Hole with Bordeaux Color	<a href="#">PE44651D</a>	\$7.54	\$7.16	\$6.79	\$6.48	71
			Thru Hole with Violet Color	<a href="#">PE44651H</a>	\$6.48	\$6.16	\$5.83	\$5.57	72
			Thru Hole with Beige Color	<a href="#">PE44651I</a>	\$6.48	\$6.16	\$5.83	\$5.57	73
			Thru Hole with Curry Color	<a href="#">PE44651K</a>	\$6.73	\$6.39	\$6.06	\$5.79	74
Thru Hole with Water Blue Color	<a href="#">PE44651Z</a>	\$7.78	\$7.39	\$7.00	\$6.69	75			
<b>Jack</b>									
Cable Connectors		Crimp/Solder	RG188-DS, RG316-DS with Black Color	<a href="#">PE45176</a>	\$5.29	\$5.03	\$4.76	\$4.55	76
			RG174, RG316, RG188, .100 inch, PE-B100, PE-C100, LMR-100 with Black Color	<a href="#">PE44646A</a>	\$6.95	\$6.60	\$6.26	\$5.98	77
			RG174, RG316, RG188, .100 inch, PE-B100, PE-C100, LMR-100 with White Color	<a href="#">PE44646B</a>	\$6.95	\$6.60	\$6.26	\$5.98	78
			RG174, RG316, RG188, .100 inch, PE-B100, PE-C100, LMR-100 with Blue Color	<a href="#">PE44646C</a>	\$6.95	\$6.60	\$6.26	\$5.98	79
			RG174, RG316, RG188, .100 inch, PE-B100, PE-C100, LMR-100 with Bordeaux Color	<a href="#">PE44646D</a>	\$6.04	\$5.74	\$5.44	\$5.19	80
			RG174, RG316, RG188, .100 inch, PE-B100, PE-C100, LMR-100 with Violet Color	<a href="#">PE44646H</a>	\$6.95	\$6.60	\$6.26	\$5.98	81
			RG174, RG316, RG188, .100 inch, PE-B100, PE-C100, LMR-100 with Beige Color	<a href="#">PE44646J</a>	\$6.20	\$5.89	\$5.58	\$5.33	82
			RG174, RG316, RG188, .100 inch, PE-B100, PE-C100, LMR-100 with Curry Color	<a href="#">PE44646K</a>	\$6.95	\$6.60	\$6.26	\$5.98	83
			RG174, RG316, RG188, .100 inch, PE-B100, PE-C100, LMR-100 with Water Blue Color	<a href="#">PE44646Z</a>	\$6.40	\$6.08	\$5.76	\$5.50	84
<b>Jack Right Angle</b>									
Cable Connectors		Crimp/Solder	RG174, RG316, RG188, .100 inch, PE-B100, PE-C100, LMR-100 with Black Color	<a href="#">PE44648A</a>	\$8.46	\$8.04	\$7.61	\$7.28	85
			RG174, RG316, RG188, .100 inch, PE-B100, PE-C100, LMR-100 with White Color	<a href="#">PE44648B</a>	\$8.46	\$8.04	\$7.61	\$7.28	86
			RG174, RG316, RG188, .100 inch, PE-B100, PE-C100, LMR-100 with Blue Color	<a href="#">PE44648C</a>	\$8.46	\$8.04	\$7.61	\$7.28	87
			RG174, RG316, RG188, .100 inch, PE-B100, PE-C100, LMR-100 with Bordeaux Color	<a href="#">PE44648D</a>	\$6.73	\$6.39	\$6.06	\$5.79	88
			RG174, RG316, RG188, .100 inch, PE-B100, PE-C100, LMR-100 with Violet Color	<a href="#">PE44648H</a>	\$7.54	\$7.16	\$6.79	\$6.48	89
			RG174, RG316, RG188, .100 inch, PE-B100, PE-C100, LMR-100 with Beige Color	<a href="#">PE44648I</a>	\$4.87	\$4.63	\$4.38	\$4.19	90
			RG174, RG316, RG188, .100 inch, PE-B100, PE-C100, LMR-100 with Curry Color	<a href="#">PE44648K</a>	\$7.54	\$7.16	\$6.79	\$6.48	91
			RG174, RG316, RG188, .100 inch, PE-B100, PE-C100, LMR-100 with Water Blue Color	<a href="#">PE44648Z</a>	\$8.16	\$7.75	\$7.34	\$7.02	92
			PCB Mount		Solder	Thru Hole with Black Color	<a href="#">PE44650A</a>	\$4.95	\$4.70
Thru Hole with White Color	<a href="#">PE44650B</a>	\$6.91				\$6.56	\$6.22	\$5.94	94
Thru Hole with Blue Color	<a href="#">PE44650C</a>	\$6.02				\$5.72	\$5.42	\$5.18	95
Thru Hole with Bordeaux Color	<a href="#">PE44650D</a>	\$5.04				\$4.79	\$4.54	\$4.33	96
Thru Hole with Violet Color	<a href="#">PE44650H</a>	\$4.22				\$4.01	\$3.80	\$3.63	97
Thru Hole with Beige Color	<a href="#">PE44650I</a>	\$5.09				\$4.84	\$4.58	\$4.38	98
Thru Hole with Curry Color	<a href="#">PE44650K</a>	\$4.84				\$4.60	\$4.36	\$4.16	99
Thru Hole with Water Blue Color	<a href="#">PE44650Z</a>	\$8.83	\$8.39	\$7.95	\$7.59	1			

# FME Connectors

Connection Method	Product Image	Attachment Cable/Contact	Coax Type / Termination Type	Model No.	PRICE				ROW
					1-24	25-49	50-99	100 +	
<b>Plug</b>									
Cable Connectors		Crimp/Solder	RG58	<a href="#">PE44295</a>	\$12.83	\$12.19	\$11.55	\$11.03	2
			RG55, RG142, RG223, RG400	<a href="#">PE44296</a>	\$10.54	\$10.01	\$9.49	\$9.06	3
			RG174, RG316, RG188	<a href="#">PE44297</a>	\$11.64	\$11.06	\$10.48	\$10.01	4
<b>Plug, Bulkhead Mount</b>									
Terminal		Solder	Solder Cup with .350 inch D Hole	<a href="#">PE44149</a>	\$8.12	\$7.71	\$7.31	\$6.98	5

\* Fits MIL-C-17 and equivalent cable versions only



Connectors

See Our Website For Current Pricing & Real-Time Stock Availability!







## FME Connectors

Connection Method	Product Image	Attachment Cable/Contact	Coax Type / Termination Type	Model No.	PRICE				ROW
					1-24	25-49	50-99	100 +	
	<b>Jack</b>								
Cable Connectors		Crimp/Solder	RG58, RG303, RG141, PE-C195, PE-P195, LMR-195, .195 inch	<a href="#">PE44146</a>	\$9.81	\$9.32	\$8.83	\$8.44	6
			RG55, RG142, RG223, RG400	<a href="#">PE44147</a>	\$8.44	\$8.02	\$7.60	\$7.26	7
			RG174, RG316, RG188	<a href="#">PE44148</a>	\$12.02	\$11.42	\$10.82	\$10.34	8

## GR874 Connectors

Connection Method	Product Image	Attachment Cable/Contact	Coax Type / Termination Type	Model No.	PRICE				ROW
					1-24	25-49	50-99	100 +	
	<b>Sexless</b>								
Cable Connectors		Crimp/Solder	RG55, RG58, RG141, RG142, RG223, RG400	<a href="#">PE4233</a>	\$27.69	\$26.31	\$24.92	\$23.81	9
			RG214, RG9, RG225, RG393	<a href="#">PE4352</a>	\$86.99	\$82.64	\$78.29	\$74.81	10
		Accessories		<a href="#">PE4348</a>	\$47.35	\$44.98	\$42.62	\$40.72	11

## HN Connectors

Connection Method	Product Image	Attachment Cable/Contact	Coax Type / Termination Type	Model No.	PRICE				ROW
					1 Pc.	See Web for Volume Pricing			
	<b>Male</b>								
Cable Connectors		Crimp/Solder	RG213, RG215, RG8	<a href="#">PE4473</a>	\$42.07	See Web for Volume Pricing			12
			RG214, RG9, RG225, RG393	<a href="#">PE4474</a>	\$42.75				13
			RG55, RG142, RG223, RG400, RG141	<a href="#">PE4477</a>	\$36.33				14
			RG58, RG141	<a href="#">PE4478</a>	\$34.31				15
		Clamp/Solder	RG213, RG214, RG8, RG9, RG225, RG393	<a href="#">PE4182</a>	\$25.96				16
			RG58, RG55, RG141, RG142, RG223, RG400, RG303, PE-C195, PE-P195, LMR-195	<a href="#">PE4198</a>	\$35.21				17
			RG14, RG217	<a href="#">PE4475</a>	\$46.45				18
			RG17, RG218, RG219	<a href="#">PE4476</a>	\$127.55				19
			RG59*, RG62*, RG71	<a href="#">PE4479</a>	\$52.67				20
	<b>Male Right Angle</b>								
Cable Connectors		Clamp/Solder	RG213, RG8, RG393, RG225, RG214, RG393, RG9	<a href="#">PE4230</a>	\$61.29				21
			RG55, RG58, RG141, RG142, RG223, RG303, RG400, PE-C195, PE-P195, LMR-195	<a href="#">PE4480</a>	\$76.07				22
			RG14, RG217	<a href="#">PE45307</a>	\$75.52				23
	<b>Female</b>								
Cable Connectors		Clamp/Solder	RG213, RG8, RG225, RG214, RG393	<a href="#">PE4229</a>	\$58.04	See Web for Volume Pricing			24
			RG401, PE-SR401AL, PE-SR401FL	<a href="#">PE4229-401</a>	\$55.86				25
	<b>Female, Bulkhead Mount</b>								
Terminal		Solder	Turret with .765 inch DD Hole	<a href="#">PE4481</a>	\$63.11				26
	<b>Female, 4 Hole Flange Mount</b>								
Terminal		Solder	Solder Cup with .906 inch Hole Spacing	<a href="#">PE4183</a>	\$31.16	See Web for Volume Pricing			27
		Field Replaceable	Slotted Contact	<a href="#">PE44718</a>	\$62.30				28

\* Fits MIL-C-17 and equivalent cable versions only







Technical Support  
+1 (949) 261-1920





Same-Day Shipping,  
Even Custom  
Cable Assemblies





## LC Connectors

Connection Method	Product Image	Attachment Cable/Contact	Coax Type / Termination Type	Model No.	PRICE				ROW
					1 Pc.	See Web for Volume Pricing			
<b>Male</b>									
Cable Connectors		Clamp/Solder	RG218, RG219, RG17	<a href="#">PE4323</a>	\$216.52				29
			RG14, RG217	<a href="#">PE4563</a>	\$190.30				30
			RG213, RG214, RG8, RG9, RG225, RG393, RG215	<a href="#">PE4564</a>	\$160.70				31
			RG55, RG58, RG141, RG142, RG223, RG303, RG400, PE-C195, PE-P195, LMR-195	<a href="#">PE4565</a>	\$150.45				32
<b>Male Right Angle</b>									
Cable Connectors		Clamp/Solder	RG213, RG214, RG8, RG9, RG225, RG393, RG215	<a href="#">PE44447</a>	\$249.43		See Web for Volume Pricing		33
<b>Female</b>									
Cable Connectors		Clamp/Solder	RG213, RG214, RG8, RG9, RG225, RG393, RG215	<a href="#">PE44450</a>	\$210.62				34
			RG17, RG218, RG219	<a href="#">PE44451</a>	\$269.43				35
<b>Female, 4 Hole Flange Mount</b>									
Terminal		Solder	Pin with 1.44 inch Hole Spacing	<a href="#">PE4192</a>	\$108.19				36
			Pin	<a href="#">PE45519</a>	\$178.00				37

## MC-Card Connectors

Connection Method	Product Image	Attachment Cable/Contact	Coax Type / Termination Type	Model No.	PRICE				ROW
					1-24	25-49	50-99	100 +	
<b>Plug</b>									
Cable Connectors		Crimp/Solder	RG174, RG316, RG188	<a href="#">PE44309</a>	\$11.02	\$10.47	\$9.92	\$9.48	38
			RG178, RG196	<a href="#">PE44310</a>	\$11.02	\$10.47	\$9.92	\$9.48	39
			RG188-DS, RG316-DS	<a href="#">PE45169</a>	\$10.89	\$10.35	\$9.80	\$9.37	40
<b>Plug Right Angle</b>									
Cable Connectors		Crimp/Solder	RG174, RG316, RG188, LMR-100, PE-B100, PE-C100, .100 inch	<a href="#">PE44308</a>	\$13.00	\$12.35	\$11.70	\$11.18	41
			RG178, RG196	<a href="#">PE44311</a>	\$14.35	\$13.63	\$12.92	\$12.34	42
			RG188-DS, RG316-DS	<a href="#">PE45168</a>	\$11.61	\$11.03	\$10.45	\$9.98	43

## MCX Connectors









Connection Method	Product Image	Attachment Cable/Contact	Coax Type / Termination Type	Model No.	PRICE				ROW
					1-24	25-49	50-99	100 +	
<b>Plug</b>									
Cable Connectors		Crimp/Solder	RG316, RG174, RG188, LMR-100, PE-B100, PE-C100, .100 inch	<a href="#">PE4551</a>	\$13.00	\$12.35	\$11.70	\$11.18	44
			RG178, RG196	<a href="#">PE4552</a>	\$18.69	\$17.76	\$16.82	\$16.07	45
			RG188-DS, RG316-DS	<a href="#">PE4878</a>	\$13.05	\$12.40	\$11.75	\$11.22	46
			RG58	<a href="#">PE4880</a>	\$23.27	\$22.34	\$21.64	\$21.18	47
			RG55, RG141, RG142, RG223, RG400	<a href="#">PE4881</a>	\$29.52	\$28.34	\$27.45	\$26.86	48
PCB Mount		Solder	Surface Mount	<a href="#">PE44613</a>	\$16.41	\$15.59	\$14.77	\$14.11	49
Cable Connectors			Thru Hole with .200 inch x .052 inch Hole Spacing	<a href="#">PE4559</a>	\$21.42	\$20.35	\$19.28	\$18.42	50
		PE-SR405AL, PE-SR405FL, PE-SR405FLJ, PE-SR405TN, RG405	<a href="#">PE4876</a>	\$22.93	\$21.78	\$20.64	\$19.72	51	
<b>Plug Right Angle</b>									
Cable Connectors		Crimp/Solder	RG174, RG316, RG188, LMR-100, PE-B100, PE-C100, .100 inch	<a href="#">PE4553</a>	\$15.80	\$15.01	\$14.22	\$13.59	52
			RG178, RG196	<a href="#">PE4554</a>	\$17.62	\$16.74	\$15.86	\$15.15	53
			RG188-DS, RG316-DS	<a href="#">PE4879</a>	\$15.91	\$15.11	\$14.32	\$13.68	54
			RG58, RG303, RG141, PE-C195, PE-P195, LMR-195, .195 inch	<a href="#">PE4882</a>	\$19.80	\$18.81	\$17.82	\$17.03	55
			RG55, RG142, RG223, RG400	<a href="#">PE4883</a>	\$15.96	\$15.16	\$14.36	\$13.73	56
		Solder/Solder	PE-SR405AL, PE-SR405FL, PE-SR405FLJ, PE-SR405TN, RG405	<a href="#">PE44698</a>	\$8.42	\$8.00	\$7.58	\$7.24	57

\* Fits MIL-C-17 and equivalent cable versions only





Connectors

See Our Website For Current Pricing & Real-Time Stock Availability!

## MCX Connectors

Connection Method	Product Image	Attachment Cable/Contact	Coax Type / Termination Type	Model No.	PRICE				ROW
					1-24	25-49	50-99	100 +	
PCB Mount		Solder	Thru Hole with .200 inch x .067 inch Hole Spacing	<a href="#">PE44830</a>	\$17.60	\$16.90	\$16.37	\$16.02	58
Cable Connectors			PE-SR405AL, PE-SR405FL, PE-SR405FLJ, PE-SR405TN, RG405	<a href="#">PE4877</a>	\$24.38	\$23.16	\$21.94	\$20.97	59
<b>Jack</b>									
Cable Connectors		Crimp/Solder	RG174, RG316, RG188, PE-B100, PE-C100, .100 inch, LMR-100	<a href="#">PE4562</a>	\$22.44	\$21.32	\$20.20	\$19.30	60
			RG178, RG196	<a href="#">PE4884</a>	\$29.27	\$27.81	\$26.34	\$25.17	61
			RG188-DS, RG316-DS	<a href="#">PE4885</a>	\$18.66	\$17.73	\$16.79	\$16.05	62
PCB Mount		Solder	Thru Hole with .200 inch x .067 inch Hole Spacing	<a href="#">PE44303</a>	\$16.96	\$16.11	\$15.26	\$14.59	63
			Surface Mount	<a href="#">PE44660</a>	\$31.66	\$30.08	\$28.49	\$27.23	64
			End Launch	<a href="#">PE44661</a>	\$20.87	\$19.83	\$18.78	\$17.95	65
			Thru Hole with .200 inch x .052 inch Hole Spacing	<a href="#">PE4555</a>	\$13.25	\$12.59	\$11.93	\$11.40	66
			Surface Mount	<a href="#">PE4889</a>	\$15.79	\$15.00	\$14.21	\$13.58	67
			.062 inch End Launch	<a href="#">PE4892</a>	\$13.34	\$12.67	\$12.01	\$11.47	68
.042 inch End Launch	<a href="#">PE4893</a>	\$23.48	\$22.31	\$21.13	\$20.19	69			
<b>Jack, Bulkhead Mount</b>									
Cable Connectors		Crimp/Solder	RG178, RG196 with .177 inch D Hole	<a href="#">PE4886</a>	\$23.73	\$22.54	\$21.36	\$20.41	70
			RG174, RG316, RG188, LMR-100, PE-B100, PE-C100, .100 inch with .177 inch D Hole	<a href="#">PE4887</a>	\$21.66	\$20.58	\$19.49	\$18.63	71
			RG188-DS, RG316-DS with .177 inch D Hole	<a href="#">PE4888</a>	\$16.75	\$15.91	\$15.08	\$14.41	72
Terminal		Solder	Turret with .177 inch D Hole	<a href="#">PE4561</a>	\$18.65	\$17.72	\$16.79	\$16.04	73
<b>Jack, 2 Hole Flange Mount</b>									
Terminal		Solder	Solder Cup with .328 inch Hole Spacing	<a href="#">PE4891</a>	\$27.24	\$25.88	\$24.52	\$23.43	74
			Pin with .328 inch Hole Spacing	<a href="#">PE4894</a>	\$26.17	\$24.86	\$23.55	\$22.51	75
<b>Jack Right Angle</b>									
PCB Mount		Solder	Thru Hole with .200 inch x .052 inch Hole Spacing	<a href="#">PE45274</a>	\$14.83	\$14.09	\$13.35	\$12.75	76
			Thru Hole with .200 inch x .052 inch Hole Spacing	<a href="#">PE4556</a>	\$16.34	\$15.52	\$14.71	\$14.05	77
			Surface Mount	<a href="#">PE4890</a>	\$21.91	\$20.81	\$19.72	\$18.84	78
<b>Jack Right Angle, Bulkhead Mount</b>									
Terminal		Solder	Turret with .177 inch D Hole	<a href="#">PE4560</a>	\$45.26	\$43.00	\$40.73	\$38.92	79

## Reverse Polarity MCX Connectors

Connection Method	Product Image	Attachment Cable/Contact	Coax Type / Termination Type	Model No.	PRICE				ROW
					1-24	25-49	50-99	100 +	
<b>Plug</b>									
Cable Connectors		Crimp/Solder	RG174, RG316, RG188, .100 inch, PE-B100, PE-C100, LMR-100	<a href="#">PE44369</a>	\$24.37	\$23.15	\$21.93	\$20.96	80
			RG178, RG196	<a href="#">PE44370</a>	\$23.70	\$22.52	\$21.33	\$20.38	81
<b>Plug Right Angle</b>									
Cable Connectors		Crimp/Solder	RG316, RG188, RG174	<a href="#">PE45050</a>	\$8.20	\$7.79	\$7.38	\$7.05	82
			RG178, RG196	<a href="#">PE45051</a>	\$7.38	\$7.08	\$6.86	\$6.72	83
<b>Jack, Bulkhead Mount</b>									
Cable Connectors		Crimp/Solder	RG174, RG316, RG188 with .177 inch D Hole	<a href="#">PE44373</a>	\$28.69	\$27.26	\$25.82	\$24.67	84
			RG178, RG196 with .177 inch D Hole	<a href="#">PE44374</a>	\$29.81	\$28.32	\$26.83	\$25.64	85
PCB Mount		Solder	End Launch with .177 inch D Hole	<a href="#">PE44377</a>	\$27.92	\$26.52	\$25.13	\$24.01	86









\* Fits MIL-C-17 and equivalent cable versions only



## Reverse Polarity MCX Connectors

Connection Method	Product Image	Attachment Cable/Contact	Coax Type / Termination Type	Model No.	PRICE				ROW
					1-24	25-49	50-99	100 +	
<b>Jack Right Angle, Bulkhead Mount</b>									
PCB Mount		Solder	Thru Hole with .177 inch D Hole	<a href="#">PE44376</a>	\$31.35	\$29.78	\$28.22	\$26.96	87

## MHV Connectors





Connection Method	Product Image	Attachment Cable/Contact	Coax Type / Termination Type	Model No.	PRICE				ROW
					1 Pc.	See Web for Volume Pricing			
<b>Male</b>									
Cable Connectors		Crimp/Solder	RG59*, RG62*, RG71	<a href="#">PE4075</a>	\$16.37	See Web for Volume Pricing			88
			RG58, RG303, RG141, PE-C195, PE-P195, LMR-195, .195 inch	<a href="#">PE4093</a>	\$26.13				89
			RG214, RG9, RG225, RG393	<a href="#">PE4350</a>	\$36.13				90
			RG213, RG8	<a href="#">PE4493</a>	\$32.66				91
			RG55, RG141, RG142, RG223, RG400	<a href="#">PE4657</a>	\$19.69				92
	RG174, RG316, RG188, LMR-100, PE-B100, PE-C100, .100 inch	<a href="#">PE4933</a>	\$42.01	93					
		Clamp/Solder	RG58, RG55, RG141, RG142, RG223, RG400, RG303, PE-C195, PE-P195, LMR-195	<a href="#">PE4076</a>	\$15.30				94
			RG59*, RG62*, RG71	<a href="#">PE4098</a>	\$16.19				95
			RG213, RG214, RG8, RG9, RG11*, RG225, RG393, RG144*, RG216*, RG215	<a href="#">PE4299</a>	\$31.69				96
			RG174, RG316, RG188	<a href="#">PE4494</a>	\$16.98				97
<b>Male Right Angle</b>									
Cable Connectors		Clamp/Solder	RG58, RG55, RG141, RG142, RG223, RG400, RG303, PE-C195, PE-P195, LMR-195	<a href="#">PE4226</a>	\$35.60				98
			RG59*, RG62*, RG71	<a href="#">PE4227</a>	\$31.60				99
			RG213, RG214, RG8, RG9, RG11*, RG225, RG393	<a href="#">PE4709</a>	\$61.20				1
			RG174, RG316, RG188	<a href="#">PE4710</a>	\$34.31				2
<b>Female</b>									
Cable Connectors		Crimp/Solder	RG55, RG141, RG142, RG223, RG400	<a href="#">PE44100</a>	\$27.34	See Web for Volume Pricing			3
			PE-P195, PE-C195, RG58, RG141, RG303, .195 inch, LMR-195	<a href="#">PE44102</a>	\$29.09				4
		Clamp/Solder	RG59*, RG62*	<a href="#">PE44103</a>	\$35.42				5
			RG59*, RG62*, RG71	<a href="#">PE4181</a>	\$23.45				6
			RG58, RG55, RG141, RG142, RG223, RG400, RG303, PE-C195, PE-P195, LMR-195	<a href="#">PE4225</a>	\$25.82	7			
			RG174, RG316, RG188	<a href="#">PE44104</a>	\$28.30	8			
<b>Female, Bulkhead Mount</b>									
Cable Connectors		Crimp/Solder	RG55, RG141, RG142, RG223, RG400	<a href="#">PE44107</a>	\$29.70	See Web for Volume Pricing			9
			RG58, RG303, RG141, PE-C195, PE-P195, LMR-195, .195 inch	<a href="#">PE44108</a>	\$40.16				10
			RG59*, RG62*, RG71	<a href="#">PE44110</a>	\$50.85				11
		Clamp/Solder	RG213, RG214, RG8, RG9, RG11*, RG225, RG393	<a href="#">PE44105</a>	\$65.55				12
			RG55, RG58, RG141, RG142, RG223, RG303, RG400, PE-C195, PE-P195, LMR-195	<a href="#">PE44106</a>	\$50.33				13
Terminal		Solder	RG59*, RG62*, RG71	<a href="#">PE44109</a>	\$43.64	14			
			RG174, RG316, RG188	<a href="#">PE44111</a>	\$48.18	15			
			Solder Cup with .380 inch DD Hole	<a href="#">PE4193</a>	\$21.89	16			
			Solder Cup with .380 inch DD Hole	<a href="#">PE4311</a>	\$47.23	17			
			Turret with .537 inch D Hole	<a href="#">PE4312</a>	\$39.49	18			
			Solder Cup	<a href="#">PE44896</a>	\$115.57	19			
			Solder Cup with .480 inch D Hole	<a href="#">PE4495</a>	\$47.69	20			
<b>Female, 4 Hole Flange Mount</b>									
Cable Connectors		Clamp/Solder	RG58, RG142, RG223, RG400, RG141, RG303, RG55, LMR-400, PE-C195, PE-P195 with .500 inch Threaded Hole Spacing	<a href="#">PE4313</a>	\$46.99				21
			RG59*, RG62*, RG71 with .500 inch Threaded Hole Spacing	<a href="#">PE4314</a>	\$50.77				22
			RG214, RG213, RG393, RG8, RG225, RG11*, RG216*, RG144*, RG215, RG9 with .718 inch Hole Spacing	<a href="#">PE44112</a>	\$53.88				23
Terminal		Solder	Solder Cup with .500 inch Threaded Hole Spacing	<a href="#">PE4228</a>	\$31.00	24			
			Solder Cup	<a href="#">PE45035</a>	\$57.92	25			

\* Fits MIL-C-17 and equivalent cable versions only







Connectors

See Our Website For Current Pricing & Real-Time Stock Availability!

## Mini SMP Connectors

Connection Method	Product Image	Attachment Cable/Contact	Coax Type / Termination Type	Model No.	PRICE				ROW
					1-24	25-49	50-99	100 +	
<b>Male</b>									
PCB Mount		Solder	Surface Mount	<a href="#">PE44489</a>	\$32.03	\$30.43	\$28.83	\$27.55	26
			End Launch	<a href="#">PE44490</a>	\$27.06	\$25.71	\$24.35	\$23.27	27
			Edge Launch	<a href="#">PE44969</a>	\$29.51	\$28.03	\$26.56	\$25.38	28
			Thru Hole	<a href="#">PE44970</a>	\$55.91	\$53.11	\$50.32	\$48.08	29
<b>Male, Solder</b>									
Terminal		Solder	Pin	<a href="#">PE44973</a>	\$38.53	\$36.60	\$34.68	\$33.14	30
<b>Male Right Angle</b>									
PCB Mount		Solder	Surface Mount	<a href="#">PE44968</a>	\$67.99	\$64.59	\$61.19	\$58.47	31
<b>Female</b>									
Cable Connectors		Solder	PE-047SR, PE-SR047AL, PE-SR047FL	<a href="#">PE44491</a>	\$39.49	\$37.52	\$35.54	\$33.96	32
			PE-SR405AL, PE-SR405FL, PE-SR405FLJ, PE-SR405TN, RG405	<a href="#">PE44492</a>	\$38.96	\$37.01	\$35.06	\$33.51	33
			PE-047SR, PE-SR047FL	<a href="#">PE44971</a>	\$44.90	\$42.66	\$40.41	\$38.61	34
			PE-SR405AL, PE-SR405FL, PE-SR405FLJ, PE-SR405TN, RG405	<a href="#">PE44974</a>	\$35.72	\$33.93	\$32.15	\$30.72	35
<b>Female Right Angle</b>									
Cable Connectors		Solder	PE-047SR, PE-SR047AL, PE-SR047FL	<a href="#">PE44493</a>	\$50.33	\$47.81	\$45.30	\$43.28	36
			PE-SR405AL, PE-SR405FL, PE-SR405FLJ, PE-SR405TN, RG405	<a href="#">PE44494</a>	\$44.86	\$42.62	\$40.37	\$38.58	37
			PE-SR405AL, PE-SR405FL, PE-SR405FLJ, PE-SR405TN, RG405	<a href="#">PE44972</a>	\$58.28	\$55.37	\$52.45	\$50.12	38

## Mini UHF Connectors

Connection Method	Product Image	Attachment Cable/Contact	Coax Type / Termination Type	Model No.	PRICE				ROW
					1-24	25-49	50-99	100 +	
<b>Male</b>									
Cable Connectors		Crimp/Solder	RG58, RG303, RG141, PE-C195, PE-P195, LMR-195, .195 inch	<a href="#">PE4342</a>	\$6.68	\$6.35	\$6.01	\$5.74	39
			RG55, RG141, RG142, RG223, RG400	<a href="#">PE44088</a>	\$10.96	\$10.41	\$9.86	\$9.43	40
			RG174, RG316, RG188	<a href="#">PE44090</a>	\$12.12	\$11.51	\$10.91	\$10.42	41
			RG55, RG141, RG142, RG223, RG400	<a href="#">PE4521</a>	\$6.68	\$6.35	\$6.01	\$5.74	42
<b>Female</b>									
Cable Connectors		Crimp/Solder	RG55, RG141, RG142, RG223, RG400	<a href="#">PE44083</a>	\$10.54	\$10.01	\$9.49	\$9.06	43
			RG58, RG303, RG141, PE-C195, PE-P195, LMR-195, .195 inch	<a href="#">PE44084</a>	\$13.82	\$13.13	\$12.44	\$11.89	44
			RG174, RG316, RG188	<a href="#">PE44085</a>	\$4.79	\$4.55	\$4.31	\$4.12	45
<b>Female, Bulkhead Mount</b>									
Cable Connectors		Crimp/Solder	RG55, RG141, RG142, RG223, RG400 with .410 inch D Hole	<a href="#">PE44086</a>	\$12.86	\$12.22	\$11.57	\$11.06	46
			.195 inch, RG58, RG141, RG303, LMR-195, LMR-195-FR, PE-C195, PE-P195 with .410 inch D Hole	<a href="#">PE44087</a>	\$15.73	\$14.94	\$14.16	\$13.53	47
Terminal		Solder	Solder Cup with .350 inch D Hole	<a href="#">PE44089</a>	\$8.29	\$7.88	\$7.46	\$7.13	48
PCB Mount			Thru Hole with .380 inch Diameter	<a href="#">PE44092</a>	\$11.31	\$10.74	\$10.18	\$9.73	49
Terminal			Solder Cup with .350 inch D Hole	<a href="#">PE4644</a>	\$6.60	\$6.27	\$5.94	\$5.68	50
<b>Female, 4 Hole Flange Mount</b>									
Terminal		Solder	Solder Cup with .437 inch Hole Spacing	<a href="#">PE44091</a>	\$11.37	\$10.80	\$10.23	\$9.78	51

\* Fits MIL-C-17 and equivalent cable versions only







Technical Support  
+1 (949) 261-1920







Same-Day Shipping,  
Even Custom  
Cable Assemblies

## MMCX Connectors

Connection Method	Product Image	Attachment Cable/Contact	Coax Type / Termination Type	Model No.	PRICE				ROW
					1-24	25-49	50-99	100 +	
	<b>Plug</b>								
Cable Connectors		Crimp/Solder	RG178, RG196	<a href="#">PE44645</a>	\$17.12	\$16.26	\$15.41	\$14.72	52
			RG188-DS, RG316-DS	<a href="#">PE44874</a>	\$18.01	\$17.11	\$16.21	\$15.49	53
			RG174, RG316, RG188, LMR-100, PE-B100, PE-C100, .100 inch	<a href="#">PE4896</a>	\$16.24	\$15.43	\$14.62	\$13.97	54
		Solder	RG178, RG196	<a href="#">PE4897</a>	\$15.84	\$15.05	\$14.26	\$13.62	55
			PE-SR405AL, PE-SR405FL, PE-SR405FLJ, PE-SR405TN, RG405	<a href="#">PE44453</a>	\$19.05	\$18.10	\$17.15	\$16.38	56
PCB Mount		Solder	PE-047SR, PE-SR047AL, PE-SR047FL	<a href="#">PE44456</a>	\$23.31	\$22.14	\$20.98	\$20.05	57
			End Launch	<a href="#">PE44663</a>	\$22.55	\$21.42	\$20.30	\$19.39	58
	<b>Thru Hole with .100 inch x .031 inch Hole Spacing</b>								
				<a href="#">PE4905</a>	\$26.64	\$25.31	\$23.98	\$22.91	59
	<b>Plug Right Angle</b>								
Cable Connectors		Crimp/Solder	RG316-DS, RG188-DS	<a href="#">PE44784</a>	\$20.50	\$19.48	\$18.45	\$17.63	60
			RG174, RG316, RG188, LMR-100, PE-B100, PE-C100, .100 inch	<a href="#">PE4898</a>	\$12.64	\$12.01	\$11.38	\$10.87	61
			RG178, RG196	<a href="#">PE4899</a>	\$18.72	\$17.78	\$16.85	\$16.10	62
		Solder/Solder	PE-SR405AL, PE-SR405FL, PE-SR405FLJ, PE-SR405TN, RG405	<a href="#">PE44699</a>	\$8.22	\$7.81	\$7.40	\$7.07	63
PE-047SR, PE-SR047AL, PE-SR047FL			<a href="#">PE44457</a>	\$24.34	\$23.12	\$21.91	\$20.93	64	
	<b>Jack</b>								
Cable Connectors		Crimp/Solder	RG316-DS, RG188-DS	<a href="#">PE44852</a>	\$18.09	\$17.19	\$16.28	\$15.56	65
			RG174, RG316, RG188, .100 inch, PE-B100, PE-C100, LMR-100	<a href="#">PE4901</a>	\$16.31	\$15.49	\$14.68	\$14.03	66
			RG178, RG196	<a href="#">PE4902</a>	\$16.31	\$15.49	\$14.68	\$14.03	67
		Solder	PE-SR405AL, PE-SR405FL, PE-SR405FLJ, PE-SR405TN, RG405	<a href="#">PE44458</a>	\$29.13	\$27.67	\$26.22	\$25.05	68
			PE-047SR, PE-SR047AL, PE-SR047FL	<a href="#">PE44459</a>	\$31.64	\$30.06	\$28.48	\$27.21	69
PCB Mount		Solder	Surface Mount	<a href="#">PE44662</a>	\$20.87	\$19.83	\$18.78	\$17.95	70
			Thru Hole with .100 inch x .031 inch Hole Spacing	<a href="#">PE4904</a>	\$13.92	\$13.22	\$12.53	\$11.97	71
	<b>Jack Right Angle</b>								
PCB Mount		Solder	Thru Hole with .100 inch x .031 inch Hole Spacing	<a href="#">PE4903</a>	\$22.32	\$21.20	\$20.09	\$19.20	72

## MMBX Connectors

Connection Method	Product Image	Attachment Cable/Contact	Coax Type / Termination Type	Model No.	PRICE				ROW
	<b>Plug</b>								
Cable Connectors		Crimp/Solder	RG178, RG196	<a href="#">PE45250</a>	\$12.22				73
			RG316, RG174	<a href="#">PE45251</a>	\$12.22				74
			RG316-DS, RG188-DS	<a href="#">PE45252</a>	\$12.22				75
PCB Mount		Solder/Solder	Surface Mount	<a href="#">PE45259TR1</a>	\$17.76				76
			Surface Mount	<a href="#">PE45259TR750</a>	\$9,354.56				77
Cable Connectors		Solder/Non-Solder Contact	RG405, PE-SR405FL, PE-SR405FLJ	<a href="#">PE45253</a>	\$13.72				78
	<b>Plug Right Angle</b>								
Cable Connectors		Crimp/Solder	RG178, RG196	<a href="#">PE45254</a>	\$15.86				79
			RG316, RG174	<a href="#">PE45255</a>	\$15.86				80
			RG316-DS, RG188-DS	<a href="#">PE45256</a>	\$15.86				81



\* Fits MIL-C-17 and equivalent cable versions only

Connectors



See Our Website For Current Pricing & Real-Time Stock Availability!



## MMBX Connectors

Connection Method	Product Image	Attachment Cable/Contact	Coax Type / Termination Type	Model No.	PRICE				ROW
					1 Pc.	See Web for Volume Pricing			
<b>Plug Right Angle</b>									
Cable Connectors		Solder/Solder	RG405, PE-SR405FL, PE-SR405FLJ	<a href="#">PE45257</a>	\$15.86				82
<b>Jack</b>									
PCB Mount		Solder	Edge Launch	<a href="#">PE45261</a>	\$16.21		See Web for Volume Pricing		83
			Surface Mount	<a href="#">PE45262TR1</a>	\$10.96			84	
			Surface Mount	<a href="#">PE45262TR750</a>	\$5,775.29			85	
			Through Hole	<a href="#">PE45265TR1</a>	\$13.26			86	
			Through Hole	<a href="#">PE45265TR500</a>	\$4,840.09			87	
<b>Jack, Thread-In</b>									
Terminal		Solder	Pin	<a href="#">PE45267</a>	\$12.32				88

## N Connectors

Connection Method	Product Image	Attachment Cable/Contact	Coax Type / Termination Type	Model No.	PRICE				ROW
					1-24	25-49	50-99	100 +	
<b>Male</b>									
Cable Connectors		Crimp/Crimp	RG55, RG141, RG142, RG223, RG400	<a href="#">PE4042</a>	\$17.42	\$16.55	\$15.68	\$14.98	89
			PE-C195, PE-P195, RG58, RG141, RG303, LMR-195, .195 inch	<a href="#">PE44520</a>	\$10.72	\$10.18	\$9.65	\$9.22	90
			RG214, RG9, RG225, RG393	<a href="#">PE4048</a>	\$17.93	\$17.03	\$16.14	\$15.42	91
	RG58, RG141, RG303, LMR-195, PE-C195, PE-P195, .195 inch	<a href="#">PE4329</a>	\$13.11	\$12.45	\$11.80	\$11.27	92		
	RG8X, PE-C240, .240 inch, B7808A, LMR-240	<a href="#">PE4344</a>	\$13.05	\$12.40	\$11.75	\$11.22	93		
	RG174, RG316, RG188, LMR-100, PE-B100, PE-C100, .100 inch	<a href="#">PE4429</a>	\$16.73	\$15.89	\$15.06	\$14.39	94		
	RG213, RG215, RG8	<a href="#">PE4430</a>	\$17.38	\$16.51	\$15.64	\$14.95	95		
	RG59*, RG62*, RG71	<a href="#">PE4432</a>	\$16.17	\$15.36	\$14.55	\$13.91	96		
	PE-C600, LMR-600, LMR-600-DB, .600 inch	<a href="#">PE44454</a>	\$33.00	\$31.68	\$30.69	\$30.03	97		
	PE-C240, RG8X, .240 inch, LMR-240, LMR-240-DB, LMR-240-UF, B7808A	<a href="#">PE44521</a>	\$15.79	\$15.00	\$14.21	\$13.58	98		
	PE-C400, PE-B400, PE-B405, LMR-400, LMR-400-DB, LMR-400-UF, .400 inch	<a href="#">PE44522</a>	\$18.52	\$17.59	\$16.67	\$15.93	99		
	PE-C600, LMR-600, LMR-600-DB, .600 inch	<a href="#">PE44523</a>	\$64.37	\$61.15	\$57.93	\$55.36	1		
	RG223, RG142, RG400, RG55	<a href="#">PE44788</a>	\$16.56	\$15.73	\$14.90	\$14.24	2		
	PE-B400, PE-B405, PE-C400, LMR-400, .400 inch	<a href="#">PE4550</a>	\$15.09	\$14.34	\$13.58	\$12.98	3		
	RG178, RG196	<a href="#">PE4647</a>	\$29.91	\$28.41	\$26.92	\$25.72	4		
	LMR-195, PE-C195	<a href="#">TC-195-NMH-X</a>	\$13.25	\$13.25	\$13.25	\$13.25	5		
	LMR-200, PE-C200	<a href="#">TC-200-NMH-X</a>	\$16.80	\$16.80	\$16.80	\$16.80	6		
	LMR-240, PE-C240	<a href="#">TC-240-NMH-X</a>	\$14.00	\$14.00	\$14.00	\$14.00	7		
	LMR-400, PE-C400, PE-B405	<a href="#">TC-400-NMH-X</a>	\$14.00	\$14.00	\$14.00	\$14.00	8		
	LMR-600, PE-C600	<a href="#">TC-600-NMH-X</a>	\$19.00	\$19.00	\$19.00	\$19.00	9		
		Clamp	7/8 inch Annular, 7/8 inch Helical, 7/8 inch Superflexible, 7/8 inch Flexible	<a href="#">PE44976</a>	\$57.78	\$54.89	\$52.00	\$49.69	10
		Clamp/Solder	PE-SR402AL, PE-SR402FL, RG402	<a href="#">PE4006</a>	\$20.50	\$19.48	\$18.45	\$17.63	11
			RG213, RG214, RG8, RG9, RG11*, RG225, RG393, RG144*, RG216*, RG215	<a href="#">PE4062</a>	\$16.30	\$15.49	\$14.67	\$14.02	12
			RG58, RG55, RG141, RG142, RG223, RG400, RG303, PE-C195, PE-P195, LMR-195	<a href="#">PE4081</a>	\$13.03	\$12.38	\$11.73	\$11.21	13
			PE-SR405AL, PE-SR405FL, RG405	<a href="#">PE4129</a>	\$20.13	\$19.12	\$18.12	\$17.31	14
			PE-C400, PE-B400, PE-B405, LMR-400, LMR-400-DB, LMR-400-UF, .400 inch	<a href="#">PE4133</a>	\$23.12	\$22.20	\$21.50	\$21.04	15
			RG14, RG217	<a href="#">PE4221</a>	\$29.75	\$28.26	\$26.78	\$25.59	16
			RG174, RG316, RG188	<a href="#">PE4224</a>	\$16.98	\$16.13	\$15.28	\$14.60	17
			RG59*, RG62*, RG71	<a href="#">PE4331</a>	\$18.99	\$18.04	\$17.09	\$16.33	18
			PE-C300	<a href="#">PE44045</a>	\$21.28	\$20.22	\$19.15	\$18.30	19
PE-C500, LMR-500			<a href="#">PE44046</a>	\$36.35	\$34.53	\$32.72	\$31.26	20	
RG17, RG218, RG219			<a href="#">PE4433</a>	\$98.86	\$93.92	\$88.97	\$85.02	21	
PE-SR401AL, PE-SR401FL, RG401			<a href="#">PE4434</a>	\$20.50	\$19.48	\$18.45	\$17.63	22	
PE-C600, .600 inch, LMR-600			<a href="#">PE44349</a>	\$74.07	\$70.37	\$66.66	\$63.70	23	

Connectors

See Our Website For Current Pricing & Real-Time Stock Availability!

\* Fits MIL-C-17 and equivalent cable versions only











Technical Support  
+1 (949) 261-1920



Same-Day Shipping,  
Even Custom  
Cable Assemblies

# N Connectors

Connection Method	Product Image	Attachment Cable/Contact	Coax Type / Termination Type	Model No.	PRICE				ROW	
					1-24	25-49	50-99	100 +		
	<b>Male</b>									
Cable Connectors		Clamp/Solder	PE-P300LL	<a href="#">PE44809</a>	\$71.47	\$67.90	\$64.32	\$61.46	24	
			PE-P142LL	<a href="#">PE44825</a>	\$44.59	\$42.36	\$40.13	\$38.25	25	
			PE-P160LL	<a href="#">PE45446</a>	\$80.44	\$76.42	\$72.40	\$69.18	26	
			LMR-240, PE-C240	<a href="#">TC-240-NMC</a>	\$17.25	\$17.25	\$17.25	\$17.25	27	
		Clamp/Solder (Captive Contact)	RG213, RG214, RG8, RG9, RG11*, RG225, RG393, RG144*, RG216*, RG215	<a href="#">PE4132</a>	\$17.20	\$16.34	\$15.48	\$14.79	28	
				Solder/Solder	PE-SR402AL, PE-SR402FL, PE-SR402FLJ, PE-SR402TN, RG402	<a href="#">PE4140</a>	\$23.66	\$22.48	\$21.29	\$20.35
	PE-SR405AL, PE-SR405FL, PE-SR405FLJ, RG405	<a href="#">PE4222</a>			\$38.09	\$36.19	\$34.28	\$32.76	30	
	PE-SR401AL, PE-SR401FL, RG401	<a href="#">PE4376</a>			\$45.21	\$42.95	\$40.69	\$38.88	31	
	PE-SR405AL, PE-SR405FL, PE-SR405FLJ, PE-SR405TN, RG405	<a href="#">PE44700</a>			\$16.70	\$15.87	\$15.03	\$14.36	32	
	PE-SR402AL, PE-SR402FL, PE-SR402FLJ, PE-SR402TN, RG402	<a href="#">PE44701</a>			\$18.37	\$17.45	\$16.53	\$15.80	33	
	PE-SR402AL, PE-SR402FL, PE-SR402FLJ, PE-SR402TN, RG402	<a href="#">PE45002</a>			\$34.53	\$32.80	\$31.08	\$29.70	34	
	SPP-250-LLPL	<a href="#">PE45427</a>			\$24.31	\$23.09	\$21.88	\$20.91	35	
	PE-047SR, PE-SR047AL, PE-SR047FL	<a href="#">PE4934</a>			\$33.64	\$31.96	\$30.28	\$28.93	36	
	SPP-250-LLPL, SPO-250, SPF-250	<a href="#">TC-250-NM-LP</a>			\$11.50	\$11.50	\$11.50	\$11.50	37	
	SPP-375-LLPL	<a href="#">TC-SPP375-NM-LP</a>			\$17.25	\$17.25	\$17.25	\$17.25	38	
		Clamp/Non-Solder Contact	LMR-400, PE-C400, PE-B400, PE-B405	<a href="#">EZ-400-NMC-2-D</a>	\$23.00	\$23.00	\$23.00	\$23.00	39	
			LMR-600, PE-C600	<a href="#">EZ-600-NMC-2-D</a>	\$23.00	\$23.00	\$23.00	\$23.00	40	
			LMR-SW396	<a href="#">EZ-SW396-NMC</a>	\$24.28	\$24.28	\$24.28	\$24.28	41	
			LMR-SW540	<a href="#">EZ-SW540-NMC</a>	\$19.20	\$19.20	\$19.20	\$19.20	42	
			1/4 inch Superflexible, PE-1/4SFHC	<a href="#">PE44726</a>	\$58.58	\$55.65	\$52.72	\$50.38	43	
			1/2 inch Helical, 1/2 inch Superflexible, PE-1/2 Helical, PE-1/2SFHC	<a href="#">PE44729</a>	\$45.88	\$43.59	\$41.29	\$39.46	44	
			PE-1/2FAC, 1/2 inch Flexible, 1/2 inch Annular	<a href="#">PE44735</a>	\$41.56	\$39.48	\$37.40	\$35.74	45	
		Crimp/Non-Solder Contact	LMR-200, PE-C200	<a href="#">EZ-200-NMH-X</a>	\$16.00	\$16.00	\$16.00	\$16.00	46	
			LMR-240, PE-C240, RG8X	<a href="#">EZ-240-NMH-X</a>	\$12.75	\$12.75	\$12.75	\$12.75	47	
			LMR-400, PE-C400	<a href="#">EZ-400-NMH-PL-X</a>	\$14.50	\$14.50	\$14.50	\$14.50	48	
			LMR-400, PE-C400, PE-B400, PE-B405	<a href="#">EZ-400-NMH-X</a>	\$13.75	\$13.75	\$13.75	\$13.75	49	
			LMR-600, PE-C600	<a href="#">EZ-600-NMH-X</a>	\$20.00	\$20.00	\$20.00	\$20.00	50	
		<b>Male, Bulkhead Mount</b>								
	Terminal		Solder	Solder Cup with .640 inch DD Hole	<a href="#">PE4489</a>	\$37.39	\$35.52	\$33.65	\$32.16	51
				Solder Cup with .350 inch D Hole	<a href="#">PE4490</a>	\$42.40	\$40.28	\$38.16	\$36.46	52
Solder Cup with .350 inch D Hole				<a href="#">PE4490BK</a>	\$41.60	\$39.52	\$37.44	\$35.78	53	
	<b>Male, 4 Hole Flange Mount</b>									
Terminal		Solder	Solder Cup with .718 inch Hole Spacing	<a href="#">PE4131</a>	\$16.75	\$15.91	\$15.08	\$14.41	54	
			Pin with .718 inch Hole Spacing	<a href="#">PE44653</a>	\$78.33	\$74.41	\$70.50	\$67.36	55	
			Pin with .718 inch Hole Spacing	<a href="#">PE4491</a>	\$33.21	\$31.55	\$29.89	\$28.56	56	
	<b>Male Right Angle</b>									
Cable Connectors		Crimp/Solder	PE-C195, PE-P195, RG58, RG141, RG303, LMR-195, .195 inch	<a href="#">PE44524</a>	\$38.81	\$37.26	\$36.09	\$35.32	57	
			PE-C240, RG8X, .240 inch, LMR-240, LMR-240-DB, LMR-240-UF, B7808A	<a href="#">PE44525</a>	\$53.52	\$50.84	\$48.17	\$46.03	58	
			PE-C400, PE-B400, PE-B405, LMR-400, LMR-400-DB, LMR-400-UF, .400 inch	<a href="#">PE44526</a>	\$40.20	\$38.19	\$36.18	\$34.57	59	
			PE-C600, LMR-600, LMR-600-DB, .600 inch	<a href="#">PE44527</a>	\$64.27	\$61.70	\$59.77	\$58.49	60	
			RG174, RG316, RG188, .100 inch, PE-B100, PE-C100, LMR-100	<a href="#">PE44675</a>	\$33.32	\$31.65	\$29.99	\$28.66	61	
			RG213, RG8	<a href="#">PE4482</a>	\$37.64	\$35.76	\$33.88	\$32.37	62	
			RG214, RG9, RG225, RG393	<a href="#">PE4483</a>	\$45.60	\$43.32	\$41.04	\$39.22	63	
			RG55, RG141, RG142, RG223, RG400	<a href="#">PE4484</a>	\$27.98	\$26.58	\$25.18	\$24.06	64	
			PE-C200, LMR-200	<a href="#">PE44844</a>	\$50.70	\$48.17	\$45.63	\$43.60	65	
			RG58	<a href="#">PE4485</a>	\$24.80	\$23.56	\$22.32	\$21.33	66	
	LMR-195, PE-C195	<a href="#">TC-195-NMH-RA-D</a>	\$15.25	\$15.25	\$15.25	\$15.25	67			
		Clamp/Solder	RG58, RG55, RG141, RG142, RG223, RG400, RG303, PE-C195, PE-P195, LMR-195	<a href="#">PE4135</a>	\$21.77	\$20.68	\$19.59	\$18.72	68	

\* Fits MIL-C-17 and equivalent cable versions only

Connectors

See Our Website For Current Pricing & Real-Time Stock Availability!

# N Connectors









Connection Method	Product Image	Attachment Cable/Contact	Coax Type / Termination Type	Model No.	PRICE		ROW		
					1 Pc.	See Web for Volume Pricing			
<b>Male Right Angle</b>									
Cable Connectors		Clamp/Solder	RG213, RG8, RG215, RG225, RG214, RG393	<a href="#">PE4136</a>	\$25.08	See Web for Volume Pricing	69		
			PE-P142LL	<a href="#">PE44816</a>	\$146.15		70		
			PE-P300LL	<a href="#">PE45225</a>	\$147.07		71		
			1/2 inch Annular, 1/2 inch Flexible, PE-1/2FAC	<a href="#">PE45358</a>	\$79.54		72		
			PE-P160LL	<a href="#">PE45448</a>	\$133.97		73		
			PE-SR401AL, PE-SR401FL, RG401	<a href="#">PE4935</a>	\$29.81		74		
	PE-B400, PE-B405, PE-C400	<a href="#">PE4938</a>	\$25.71	75					
		Solder/Solder	PE-SR405AL, PE-SR405FL, PE-SR405FLJ, RG405	<a href="#">PE44702</a>	\$20.97		76		
			PE-SR402AL, PE-SR402FL, PE-SR402FLJ, PE-SR402TN, RG402	<a href="#">PE44703</a>	\$23.07		77		
			SPP-250-LLPL	<a href="#">PE45428</a>	\$28.48		78		
			PE-SR402AL, PE-SR402FL, RG402	<a href="#">PE4936</a>	\$36.17		79		
			PE-SR405AL, PE-SR405FL, PE-SR405FLJ, RG405	<a href="#">PE4937</a>	\$25.70		80		
			LMR-400, PE-C400, PE-B405	<a href="#">TC-400-NMH-RA-D</a>	\$20.00		81		
		Clamp/Non-Solder Contact	SPO-500, SPF-500	<a href="#">TC-SPO500-NM-RA-LP</a>	\$13.80		82		
			LMR-SW396	<a href="#">EZ-SW396-NMC-RA</a>	\$26.59		83		
		Crimp/Non-Solder Contact	1/2 inch Helical, 1/2 inch Superflexible, PE-1/2 Helical, PE-1/2SFHC	<a href="#">PE44554</a>	\$79.13		84		
LMR-400, PE-C400, PE-B400, PE-B405			<a href="#">EZ-400-NMH-RA-X</a>	\$23.00	85				
		LMR-600, PE-C600	<a href="#">EZ-600-NMH-RA-X</a>	\$28.75	86				
<b>Female</b>									
Cable Connectors		Crimp/Solder	RG55, RG141, RG142, RG223, RG400	<a href="#">PE4134</a>	\$17.28	See Web for Volume Pricing	87		
			RG214, RG9, RG225, RG393	<a href="#">PE4191</a>	\$16.78		88		
			RG213, RG8	<a href="#">PE4435</a>	\$15.91		89		
			RG58	<a href="#">PE4436</a>	\$15.48		90		
			RG174, RG316, RG188, LMR-100, PE-B100, PE-C100, .100 inch	<a href="#">PE4438</a>	\$23.01		91		
			PE-C195, PE-P195, RG58, RG141, RG303, LMR-195, .195 inch	<a href="#">PE44532</a>	\$15.96		92		
			PE-C240, RG8X, .240 inch, LMR-240, LMR-240-DB, LMR-240-UF, B7808A	<a href="#">PE44533</a>	\$17.23		93		
			PE-C400, PE-B400, PE-B405, LMR-400, LMR-400-DB, LMR-400-UF, .400 inch	<a href="#">PE44534</a>	\$25.32		94		
			PE-C600, LMR-600, LMR-600-DB, .600 inch	<a href="#">PE44535</a>	\$49.92		95		
			RG223, RG142, RG400, RG55	<a href="#">PE44789</a>	\$20.66		96		
			RG188-DS, RG316-DS	<a href="#">PE45172</a>	\$20.97		97		
			LMR-400, PE-C400	<a href="#">TC-400-NF-X</a>	\$17.25		98		
				Clamp/Solder	RG213, RG214, RG8, RG9, RG11*, RG225, RG393, RG144*, RG216*, RG215		<a href="#">PE4061</a>	\$16.95	99
					RG58, RG55, RG141, RG142, RG223, RG400, RG303, PE-C195, PE-P195, LMR-195		<a href="#">PE4072</a>	\$17.45	1
	PE-SR405AL, PE-SR405FL, RG405	<a href="#">PE4130</a>			\$18.04		2		
	PE-SR402AL, PE-SR402FL, RG402	<a href="#">PE4138</a>			\$20.50		3		
	RG59*, RG62*, RG71	<a href="#">PE4330</a>			\$17.98		4		
	PE-B400, PE-B405, PE-C400, LMR-400, .400 inch	<a href="#">PE4372</a>			\$31.31		5		
	PE-C600	<a href="#">PE44350</a>			\$75.52		6		
	RG174, RG316, RG188	<a href="#">PE4437</a>			\$19.69		7		
	PE-SR401AL, PE-SR401FL, RG401	<a href="#">PE4439</a>			\$23.52		8		
	1/2 inch Helical	<a href="#">PE44555</a>			Call		9		
	1/2 inch Annular	<a href="#">PE44565</a>			\$82.83		10		
	PE-P300LL	<a href="#">PE45245</a>			\$103.14		11		
	RG14, RG217	<a href="#">PE4645</a>			\$64.35		12		
	RG17, RG218, RG219	<a href="#">PE4646</a>			\$77.86		13		
		Clamp/Solder (Captive Contact)	RG213, RG214, RG8, RG9, RG11*, RG225, RG393, RG144*, RG216*, RG215	<a href="#">PE4059</a>	\$30.51		14		
				Solder/Solder	PE-SR405AL, PE-SR405FL, PE-SR405FLJ, RG405		<a href="#">PE44704</a>	\$21.36	15
	PE-SR402AL, PE-SR402FL, PE-SR402FLJ, PE-SR402TN, RG402	<a href="#">PE44705</a>			\$23.07		16		
	SPP-250-LLPL	<a href="#">PE45426</a>			\$24.31		17		
	PE-SR402AL, PE-SR402FL, RG402	<a href="#">PE4652</a>			\$47.22		18		
	PE-SR405AL, PE-SR405FL, PE-SR405FLJ, RG405	<a href="#">PE4653</a>			\$30.86		19		
PE-047SR, PE-SR047AL, PE-SR047FL	<a href="#">PE4945</a>	\$38.93			20				
SPP-250-LLPL	<a href="#">TC-SPP250-NF-LP</a>	\$11.50	21						

Connectors

See Our Website For Current Pricing & Real-Time Stock Availability!

\* Fits MIL-C-17 and equivalent cable versions only

# N Connectors













Connection Method	Product Image	Attachment Cable/Contact	Coax Type / Termination Type	Model No.	PRICE			ROW
					1 Pc.	See Web for Volume Pricing		
<b>Female</b>								
Cable Connectors		Solder/Solder	SPO-375, SPF-375	<a href="#">TC-SPP375-NF-LP</a>	\$13.80			22
PCB Mount		Solder	Thru Hole with .400 inch x .062 inch Hole Spacing	<a href="#">PE44396</a>	\$27.32			23
Cable Connectors		Clamp/Non-Solder Contact	1/4 inch Superflexible, PE-1/4SFHC	<a href="#">PE44727</a>	\$58.68	See Web for Volume Pricing		24
			1/2 inch Helical, 1/2 inch Superflexible, PE-1/2 Helical, PE-1/2SFHC	<a href="#">PE44731</a>	\$45.09			25
			PE-1/2FAC, 1/2 inch Flexible, 1/2 inch Annular	<a href="#">PE44737</a>	\$43.40			26
			7/8 inch annular	<a href="#">PE45036</a>	\$62.43			27
			7/8 inch Helical	<a href="#">PE45203</a>	\$50.52			28
		Crimp/Non-Solder Contact	LMR-600, PE-C600	<a href="#">EZ-600-NF-X</a>	\$23.00			29
<b>Female, Bulkhead Mount</b>								
Cable Connectors		Crimp/Crimp	RG55, RG142, RG223, RG400 with .640 inch DD Hole	<a href="#">PE4371</a>	\$20.73	See Web for Volume Pricing		30
			RG58, RG141 with .640 inch DD Hole	<a href="#">PE4440</a>	\$17.56			31
		Crimp/Solder	RG174, RG316, RG188, LMR-100, PE-B100, PE-C100, .100 inch with .640 inch DD Hole	<a href="#">PE4442</a>	\$27.31			32
			PE-C195, PE-P195, RG58, RG141, RG303, LMR-195, .195 inch with .640 inch DD Hole	<a href="#">PE44528</a>	\$24.80			33
			.240 inch, RG8X, LMR-240, B7808A, LMR-240-DB, LMR-240-UF, PE-C240 with .640 inch DD Hole	<a href="#">PE44529</a>	\$18.10			34
			.400 inch, LMR-400, LMR-400-DB, LMR-400-UF, PE-B405, PE-C400, PE-B400 with .640 inch DD Hole	<a href="#">PE44530</a>	\$24.09			35
			PE-C600, LMR-600 with .640 inch DD Hole	<a href="#">PE44531</a>	\$46.01			36
			RG188-DS, RG316-DS	<a href="#">PE44877</a>	\$29.65			37
			LMR-200, PE-C200	<a href="#">PE45047</a>	\$22.60			38
			RG213, RG8 with .640 inch DD Hole	<a href="#">PE4940</a>	\$30.97			39
			RG214, RG9, RG225, RG393 with .640 inch DD Hole	<a href="#">PE4941</a>	\$18.78			40
			LMR-240, PE-C240	<a href="#">TC-240-NF-BH-X</a>	\$22.50			41
		Clamp/Solder	PE-SR402AL, PE-SR402FL, RG402 with .640 inch DD Hole	<a href="#">PE4113</a>	\$18.93			42
			RG58, RG142, RG223, RG400, RG141, RG303, RG55, LMR-400, PE-C195, PE-P195 with .640 inch DD Hole	<a href="#">PE4114</a>	\$20.91			43
			RG214, RG213, RG393, RG8, RG225, RG11*, RG216*, RG144*, RG215, RG9 with .640 inch DD Hole	<a href="#">PE4223</a>	\$25.80			44
			RG59*, RG62* with .640 inch DD Hole	<a href="#">PE4297</a>	\$28.42			45
			RG174, RG316, RG188 with .640 inch DD Hole	<a href="#">PE4441</a>	\$21.82			46
			PE-SR405AL, PE-SR405FL, RG405, PE-SR405TN with .640 inch DD Hole	<a href="#">PE4443</a>	\$20.50			47
			RG178 with .640 inch DD Hole	<a href="#">PE44633</a>	\$21.82			48
			PE-P300LL	<a href="#">PE44807</a>	\$116.15			49
			PE-P142LL	<a href="#">PE44813</a>	\$98.29			50
			RG188-DS, RG316-DS with .640 inch DD Hole	<a href="#">PE45173</a>	\$19.87			51
			PE-P160LL	<a href="#">PE45447</a>	\$102.71			52
			PE-SR401AL, PE-SR401FL, RG401 with .640 inch DD Hole	<a href="#">PE4942</a>	\$25.03			53
			PE-B400, PE-B405, PE-C400 with .640 inch DD Hole	<a href="#">PE4943</a>	\$22.56			54
			PE-SR405AL, PE-SR405FL, PE-SR405FLJ, PE-SR405TN, RG405	<a href="#">PE44706</a>	\$23.07			55
				Solder/Solder	PE-SR402AL, PE-SR402FL, PE-SR402FLJ, PE-SR402TN, RG402			<a href="#">PE44707</a>
	PE-SR402AL, PE-SR402FL, PE-SR402FLJ, PE-SR402TN, RG402 with .640 inch DD Hole	<a href="#">PE4654</a>			\$37.85			57
	PE-SR405AL, PE-SR405FL, RG405 with .640 inch DD Hole	<a href="#">PE4655</a>			\$36.47			58
	PE-047SR, PE-SR047AL, PE-SR047FL with .640 inch DD Hole	<a href="#">PE4946</a>			\$34.27			59
SPP-250-LLPL	<a href="#">TC-SPP250-NF-BH-LP</a>	\$11.50			60			
Terminal		Solder	Solder Cup with .640 inch DD Hole	<a href="#">PE4137</a>	\$19.75			61
			Pin with .640 inch DD Hole	<a href="#">PE4139</a>	\$12.72			62

\* Fits MIL-C-17 and equivalent cable versions only

Connectors

See Our Website For Current Pricing & Real-Time Stock Availability!

# N Connectors



Connection Method	Product Image	Attachment Cable/Contact	Coax Type / Termination Type	Model No.	PRICE				ROW
					1-24	25-49	50-99	100 +	
<b>Female, Bulkhead Mount</b>									
PCB Mount		Solder	Thru Hole with .640 inch DD Hole	<a href="#">PE44397</a>	\$39.34	\$37.37	\$35.41	\$33.83	63
			End Launch with .630 inch Diameter	<a href="#">PE44615</a>	\$31.32	\$29.75	\$28.19	\$26.94	64
Terminal		Solder Cup with .380 inch Diameter	<a href="#">PE4488</a>	\$14.57	\$13.84	\$13.11	\$12.53	65	
Cable Connectors		Crimp/Non-Solder Contact	LMR-400, PE-C400, PE-B400, PE-B405	<a href="#">EZ-400-NF-BH</a>	\$23.00	\$23.00	\$23.00	\$23.00	66
			LMR-600, PE-C600	<a href="#">EZ-600-NF-BH</a>	\$38.00	\$38.00	\$38.00	\$38.00	67
<b>Female, 2 Hole Flange Mount</b>									
Terminal		Solder	Solder Cup with 1.0 inch Hole Spacing	<a href="#">PE44077</a>	\$28.54	\$27.11	\$25.69	\$24.54	68
			Pin with 1.0 inch Hole Spacing	<a href="#">PE44079</a>	\$48.22	\$45.81	\$43.40	\$41.47	69
<b>Female, 4 Hole Flange Mount</b>									
Cable Connectors		Crimp/Solder	RG213, RG8 with .718 inch Hole Spacing	<a href="#">PE44065</a>	\$21.95	\$20.85	\$19.76	\$18.88	70
			RG214, RG9, RG225, RG393 with .718 inch Hole Spacing	<a href="#">PE44066</a>	\$25.82	\$24.53	\$23.24	\$22.21	71
			RG55, RG141, RG142, RG223, RG400 with .718 inch Hole Spacing	<a href="#">PE44068</a>	\$23.95	\$22.75	\$21.56	\$20.60	72
			.195 inch, RG58, RG141, RG303, LMR-195, LMR-195-FR, PE-C195, PE-P195 with .718 inch Hole Spacing	<a href="#">PE44069</a>	\$24.17	\$22.96	\$21.75	\$20.79	73
		Clamp/Solder	RG316, RG174, LMR-100	<a href="#">PE45133</a>	\$20.50	\$19.48	\$18.45	\$17.63	74
			RG58, RG142, RG223, RG400, RG141, RG303, RG55, LMR-400, PE-C195, PE-P195 with .718 inch Hole Spacing	<a href="#">PE4141</a>	\$16.82	\$15.98	\$15.14	\$14.47	75
			RG174, RG316, RG188 with .718 inch Hole Spacing	<a href="#">PE44070</a>	\$18.73	\$17.79	\$16.86	\$16.11	76
			PE-SR401AL, PE-SR401FL, RG401 with .718 inch Hole Spacing	<a href="#">PE44071</a>	\$24.80	\$23.56	\$22.32	\$21.33	77
			PE-SR402AL, PE-SR402FL, PE-SR402FLJ, PE-SR402TN, RG402 with .718 inch Hole Spacing	<a href="#">PE44072</a>	\$25.03	\$23.78	\$22.53	\$21.53	78
			PE-SR405AL, PE-SR405FL, RG405 with .718 inch Hole Spacing	<a href="#">PE44073</a>	\$24.64	\$23.41	\$22.18	\$21.19	79
		Clamp/Solder (Captive Contact)	RG214, RG213, RG393, RG8, RG225, RG11*, RG216*, RG144*, RG215, RG9 with .718 inch Hole Spacing	<a href="#">PE4060</a>	\$26.04	\$24.74	\$23.44	\$22.39	80
				Solder	Pin with .718 inch Hole Spacing	<a href="#">PE4328</a>	\$20.47	\$19.45	\$18.42
Pin with .340 inch Hole Spacing	<a href="#">PE4355</a>	\$21.40			\$20.33	\$19.26	\$18.40	82	
Pin with .500 inch Hole Spacing	<a href="#">PE4444</a>	\$23.05			\$21.90	\$20.75	\$19.82	83	
Solder Cup with .718 inch Hole Spacing	<a href="#">PE4487</a>	\$58.26			\$55.35	\$52.43	\$50.10	84	
Tab with .718 inch Hole Spacing	<a href="#">PE4492</a>	\$31.63			\$30.05	\$28.47	\$27.20	85	
Solder Cup	<a href="#">PE45085</a>	\$18.31			\$17.39	\$16.48	\$15.75	86	
	Field Replaceable	Slotted Contact	<a href="#">PE44721</a>	\$32.22	\$30.61	\$29.00	\$27.71	87	
		Slotted Contact	<a href="#">PE44722</a>	\$33.15	\$31.49	\$29.84	\$28.51	88	
<b>Female, Press-In</b>									
Terminal		Solder	Pin with .500 inch Diameter	<a href="#">PE44074</a>	\$29.30	\$27.84	\$26.37	\$25.20	89
			Tab with .500 inch Diameter	<a href="#">PE44075</a>	\$18.79	\$17.85	\$16.91	\$16.16	90
			Solder Cup with .500 inch Diameter	<a href="#">PE44076</a>	\$17.71	\$16.82	\$15.94	\$15.23	91
<b>Female Right Angle, Bulkhead Mount</b>									
PCB Mount		Solder	Thru Hole with .596 inch D Hole	<a href="#">PE44398</a>	\$26.35	\$25.03	\$23.72	\$22.66	92
<b>Female Right Angle, 4 Hole Flange Mount</b>									
Terminal		Solder	Solder Cup with .718 inch Hole Spacing	<a href="#">PE4486</a>	\$46.56	\$44.23	\$41.90	\$40.04	93

Connectors

See Our Website For Current Pricing & Real-Time Stock Availability!

\* Fits MIL-C-17 and equivalent cable versions only

## Reverse Polarity N Connectors

Connection Method	Product Image	Attachment Cable/Contact	Coax Type / Termination Type	Model No.	PRICE				ROW
					1-24	25-49	50-99	100 +	
<b>Male</b>									
Cable Connectors		Crimp/Solder	PE-C400, PE-B400, PE-B405, LMR-400, LMR-400-DB, LMR-400-UF, .400 inch	<a href="#">PE44470</a>	\$34.78	\$33.04	\$31.30	\$29.91	94
			RG213, RG8, RG215	<a href="#">PE44472</a>	\$34.78	\$33.04	\$31.30	\$29.91	95
			RG214, RG393	<a href="#">PE44474</a>	\$29.44	\$27.97	\$26.50	\$25.32	96
<b>Female</b>									
Cable Connectors		Crimp/Solder	RG55, RG141, RG142, RG223, RG400	<a href="#">PE44475</a>	\$28.17	\$26.76	\$25.35	\$24.23	97
			RG58	<a href="#">PE44476</a>	\$31.01	\$29.46	\$27.91	\$26.67	98
			RG214, RG9, RG225, RG393	<a href="#">PE44477</a>	\$30.43	\$28.91	\$27.39	\$26.17	99
			RG213, RG8	<a href="#">PE44478</a>	\$24.87	\$23.63	\$22.38	\$21.39	1

## N, 7mm, SC Torque Wrenches







Type	Bit Hex Size (in.)	Preset Torque (in.-lbs.)	Model No.	1-9	10-24	25-49	50+	ROW
N, 7mm, SC	20 mm	14 in.-lbs	<a href="#">PE5011-7</a>	\$318.02	\$305.30	\$295.76	\$289.40	
		8.1 in.-lbs	<a href="#">PE5019-5</a>	\$224.24	\$213.03	\$201.82	\$192.85	
	3/4 inch	14 in.-lbs	<a href="#">PE5019-4</a>	\$222.15	\$211.04	\$199.94	\$191.05	
	13/16 inch	14 in.-lbs	<a href="#">PE5019-8</a>	\$222.15	\$211.04	\$199.94	\$191.05	

## NMO Mount Connectors

Connection Method	Product Image	Attachment Cable/Contact	Coax Type / Termination Type	Model No.	PRICE				ROW
					1-24	25-49	50-99	100 +	
<b>Sexless</b>									
Cable Connectors		Crimp/Solder	PE-C195, PE-P195, RG58, RG55, RG141, RG142, RG223, RG400, RG303, LMR-195	<a href="#">PE51021</a>	\$14.80	\$14.06	\$13.32	\$12.73	2
			RG58, LMR-195	<a href="#">PE51167</a>	\$22.20	\$21.09	\$19.98	\$19.09	3

## QMA Connectors







Connection Method	Product Image	Attachment Cable/Contact	Coax Type / Termination Type	Model No.	PRICE				ROW
					1-24	25-49	50-99	100 +	
<b>Male</b>									
Cable Connectors		Crimp/Solder	RG174, RG316, RG188, .100 inch, PE-B100, PE-C100, LMR-100	<a href="#">PE44501</a>	\$24.53	\$23.30	\$22.08	\$21.10	4
			PE-C195, PE-P195, RG58, RG141, RG303, LMR-195, .195 inch	<a href="#">PE44503</a>	\$20.67	\$19.64	\$18.60	\$17.78	5
			RG55, RG142, RG223, RG400	<a href="#">PE44514</a>	\$19.77	\$18.78	\$17.79	\$17.00	6
			LMR-200, PE-C200	<a href="#">PE45224</a>	\$11.26	\$10.70	\$10.13	\$9.68	7
		Solder/Solder	PE-SR405AL, PE-SR405FL, RG405	<a href="#">PE44495</a>	\$21.64	\$20.56	\$19.48	\$18.61	8
			SPP-250-LLPL	<a href="#">PE45430</a>	\$20.84	\$19.80	\$18.76	\$17.92	9
		Solder/Non-Solder Contact	PE-SR402AL, PE-SR402FL, PE-SR402FLJ, PE-SR402TN, RG402	<a href="#">PE44496</a>	\$45.26	\$43.00	\$40.73	\$38.92	10
<b>Male Right Angle</b>									
Cable Connectors		Crimp/Solder	RG316-DS, RG188-DS	<a href="#">PE44505</a>	\$30.89	\$29.35	\$27.80	\$26.57	11
			PE-C195, PE-P195, RG58, RG141, RG303, LMR-195, .195 inch	<a href="#">PE44506</a>	\$26.34	\$25.02	\$23.71	\$22.65	12
			RG55, RG142, RG223, RG400	<a href="#">PE44515</a>	\$29.62	\$28.14	\$26.66	\$25.47	13
			RG174, RG316, RG188	<a href="#">PE45284</a>	\$22.05	\$20.95	\$19.85	\$18.96	14
		Solder/Solder	PE-SR405AL, PE-SR405FL, RG405	<a href="#">PE44497</a>	\$24.37	\$23.15	\$21.93	\$20.96	15
			PE-SR402AL, PE-SR402FL, PE-SR402FLJ, PE-SR402TN, RG402	<a href="#">PE44498</a>	\$26.63	\$25.30	\$23.97	\$22.90	16

\* Fits MIL-C-17 and equivalent cable versions only







Connectors

See Our Website For Current Pricing & Real-Time Stock Availability!

## QMA Connectors

Connection Method	Product Image	Attachment Cable/Contact	Coax Type / Termination Type	Model No.	PRICE				ROW
					1-24	25-49	50-99	100 +	
<b>Male Right Angle</b>									
Cable Connectors		Solder/Solder	SPP-250-LLPL	<a href="#">PE45431</a>	\$22.93	\$21.78	\$20.64	\$19.72	17
		Crimp/Non-Solder Contact	LMR-240, PE-C240, LMR-240-UF	<a href="#">EZ-240-QM-RA-X</a>	\$19.50	\$19.50	\$19.50	\$19.50	18
<b>Female</b>									
Cable Connectors		Solder/Solder	SPP-250-LLPL	<a href="#">PE45429</a>	\$17.38	\$16.51	\$15.64	\$14.95	19
PCB Mount		Solder	Surface Mount	<a href="#">PE44510</a>	\$23.44	\$22.27	\$21.10	\$20.16	20
			Thru Hole	<a href="#">PE44512</a>	\$14.84	\$14.10	\$13.36	\$12.76	21
<b>Female, Bulkhead Mount</b>									
Cable Connectors		Crimp/Solder	RG174, RG316, RG188, .100 inch, PE-B100, PE-C100, LMR-100 with .268 inch D Hole	<a href="#">PE44507</a>	\$18.64	\$17.71	\$16.78	\$16.03	22
			RG316-DS, RG188-DS with .268 inch D Hole	<a href="#">PE44508</a>	\$18.21	\$17.30	\$16.39	\$15.66	23
			RG58, RG141 with .268 inch D Hole	<a href="#">PE44509</a>	\$21.64	\$20.56	\$19.48	\$18.61	24
		Solder/Solder	PE-SR402AL, PE-SR402FL, PE-SR402FLJ, PE-SR402TN, RG402 with .268 inch D Hole	<a href="#">PE44500</a>	\$21.32	\$20.25	\$19.19	\$18.34	25
			PE-SR405AL, PE-SR405FL, RG405 with .268 inch D Hole	<a href="#">PE45218</a>	\$28.66	\$27.23	\$25.79	\$24.65	26
<b>Female Right Angle</b>									
PCB Mount		Solder	Surface Mount	<a href="#">PE44511</a>	\$14.38	\$13.80	\$13.37	\$13.09	27
			Thru Hole	<a href="#">PE44513</a>	\$22.56	\$21.43	\$20.30	\$19.40	28

## QN Connectors

Connection Method	Product Image	Attachment Cable/Contact	Coax Type / Termination Type	Model No.	PRICE				ROW
					1-24	25-49	50-99	100 +	
<b>Male</b>									
Cable Connectors		Crimp/Solder	RG213, RG215	<a href="#">PE44597</a>	\$69.86	\$67.07	\$64.97	\$63.57	29
			RG55, RG141, RG142, RG223, RG400	<a href="#">PE44978</a>	\$30.40	\$28.88	\$27.36	\$26.14	30
			RG58, RG303, RG141, PE-C195, PE-P195, LMR-195	<a href="#">PE45071</a>	\$25.47	\$24.45	\$23.69	\$23.18	31
			LMR-240, PE-C240	<a href="#">PE45222</a>	\$30.19	\$28.98	\$28.08	\$27.47	32
		Solder/Solder	PE-SR402AL, PE-SR402FL, RG402	<a href="#">PE44599</a>	\$36.13	\$34.32	\$32.52	\$31.07	33
<b>Male Right Angle</b>									
Cable Connectors		Crimp/Solder	RG55, RG141, RG142, RG223, RG400	<a href="#">PE44600</a>	\$43.80	\$41.61	\$39.42	\$37.67	34
			PE-C195, PE-P195, RG58, RG141, RG303, LMR-195, .195 inch	<a href="#">PE44601</a>	\$41.38	\$39.31	\$37.24	\$35.59	35
			RG214, RG225	<a href="#">PE44603</a>	\$42.61	\$40.48	\$38.35	\$36.64	36
			LMR-400, PE-C400, LMR-400-DB	<a href="#">PE45223</a>	\$49.40	\$46.93	\$44.46	\$42.48	37
		Solder/Solder	PE-SR402AL, PE-SR402FL, PE-SR402FLJ, PE-SR402TN, RG402	<a href="#">PE44604</a>	\$41.23	\$39.17	\$37.11	\$35.46	38
<b>Female, Bulkhead Mount</b>									
Cable Connectors		Crimp/Solder	RG213, RG215 with .500 inch Diameter	<a href="#">PE44607</a>	\$46.53	\$44.20	\$41.88	\$40.02	39
			RG214, RG225 with .500 inch Diameter	<a href="#">PE44608</a>	\$93.92	\$90.16	\$87.35	\$85.47	40
		Solder/Solder	PE-SR402AL, PE-SR402FL, PE-SR402FLJ, PE-SR402TN, RG402 with .500 inch Diameter	<a href="#">PE44609</a>	\$50.25	\$47.74	\$45.23	\$43.22	41
<b>Female, 4 Hole Flange Mount</b>									
Terminal		Solder	Solder Cup	<a href="#">PE44610</a>	\$66.52	\$63.19	\$59.87	\$57.21	42

\* Fits MIL-C-17 and equivalent cable versions only



Technical Support  
+1 (949) 261-1920







Same-Day Shipping,  
Even Custom  
Cable Assemblies







Connectors

See Our Website For Current Pricing & Real-Time Stock Availability!

## SC Connectors

Connection Method	Product Image	Attachment Cable/Contact	Coax Type / Termination Type	Model No.	PRICE				ROW
					1 Pc.	See Web for Volume Pricing			
<b>Male</b>									
Cable Connectors		Crimp/Solder	RG55, RG141, RG142, RG223, RG400	<a href="#">PE4231</a>	\$125.89	See Web for Volume Pricing			43
			RG214, RG9, RG225, RG393	<a href="#">PE4232</a>	\$63.76				44
		Clamp/Solder	RG213, RG214, RG8, RG9, RG225, RG393, RG215	<a href="#">PE4520</a>	\$176.44				45
			RG55, RG58, RG141, RG142, RG223, RG303, RG400, PE-C195, PE-P195, LMR-195	<a href="#">PE45479</a>	\$123.54				46
<b>Male Right Angle</b>									
Cable Connectors		Clamp/Solder	RG58, RG55, RG141, RG142, RG223, RG400	<a href="#">PE4978</a>	\$141.16				47
			RG213, RG214, RG8, RG9, RG225, RG393, RG215	<a href="#">PE4979</a>	\$168.55				48
<b>Female, Bulkhead Mount</b>									
Terminal		Solder	Eyelet with .655 inch D Hole	<a href="#">PE4980</a>	\$38.29			See Web for Volume Pricing	49
<b>Female, 4 Hole Flange Mount</b>									
Terminal		Solder	Solder Cup with .718 inch Hole Spacing	<a href="#">PE4322</a>	\$41.36				50

## SHV Connectors

Connection Method	Product Image	Attachment Cable/Contact	Coax Type / Termination Type	Model No.	PRICE				ROW
					1-24	25-49	50-99	100 +	
<b>Plug</b>									
Cable Connectors		Crimp/Solder	RG58, RG303, RG141, PE-C195, PE-P195, LMR-195, .195 inch	<a href="#">PE4194</a>	\$45.23	\$42.97	\$40.71	\$38.90	51
			RG59*, RG62*, RG71	<a href="#">PE4343</a>	\$40.41	\$38.39	\$36.37	\$34.75	52
			RG214, RG9, RG225, RG393	<a href="#">PE4349</a>	\$37.65	\$35.77	\$33.89	\$32.38	53
			RG213, RG8	<a href="#">PE4496</a>	\$35.34	\$33.57	\$31.81	\$30.39	54
		Clamp/Solder	RG55, RG142, RG223, RG400	<a href="#">PE4497</a>	\$35.67	\$33.89	\$32.10	\$30.68	55
			RG59*, RG62*, RG71	<a href="#">PE4100</a>	\$25.15	\$23.89	\$22.64	\$21.63	56
			RG58, RG55, RG141, RG142, RG223, RG400, RG303, PE-C195, PE-P195, LMR-195	<a href="#">PE4316</a>	\$25.08	\$23.83	\$22.57	\$21.57	57
			RG8, RG213, RG214	<a href="#">PE4333</a>	\$38.33	\$36.41	\$34.50	\$32.96	58
			RG174, RG316, RG188, LMR-100, PE-B100, PE-C100, .100 inch	<a href="#">PE4498</a>	\$40.22	\$38.21	\$36.20	\$34.59	59
<b>Plug, Bulkhead Mount</b>									
Terminal		Solder	Solder Cup with .350 inch D Hole	<a href="#">PE44118</a>	\$49.91	\$47.41	\$44.92	\$42.92	60
<b>Jack, Bulkhead Mount</b>									
Cable Connectors		Clamp/Solder	RG59*, RG62*, RG71 with .480 inch D Hole	<a href="#">PE4315</a>	\$48.64	\$46.21	\$43.78	\$41.83	61
			RG213, RG214, RG8, RG9, RG225, RG393, RG215 with .480 inch D Hole	<a href="#">PE44049</a>	\$64.33	\$61.11	\$57.90	\$55.32	62
			RG58, RG142, RG223, RG400, RG141, RG303, RG55, LMR-400, PE-C195, PE-P195 with .480 inch D Hole	<a href="#">PE44080</a>	\$48.64	\$46.21	\$43.78	\$41.83	63
Terminal		Solder	Solder Cup with .350 inch D Hole	<a href="#">PE4239</a>	\$22.60	\$21.47	\$20.34	\$19.44	64
			Solder Cup with .480 inch D Hole	<a href="#">PE4499</a>	\$27.24	\$25.88	\$24.52	\$23.43	65
			Solder Cup with .350 inch D Hole	<a href="#">PE4500</a>	\$65.45	\$62.18	\$58.91	\$56.29	66
<b>Jack, 4 Hole Flange Mount</b>									
Terminal		Solder	Solder Cup with .500 inch Hole Spacing	<a href="#">PE4501</a>	\$37.13	\$35.27	\$33.42	\$31.93	67





\* Fits MIL-C-17 and equivalent cable versions only

Connectors

See Our Website For Current Pricing & Real-Time Stock Availability!



# SMA Connectors

Connection Method	Product Image	Attachment Cable/Contact	Coax Type / Termination Type	Model No.	PRICE		ROW
					1 Pc.	See Web for Volume Pricing	
<b>Male</b>							
Cable Connectors		Crimp/Crimp	RG174, RG316, RG188, LMR-100, PE-B100, PE-C100, .100 inch	<a href="#">PE4003</a>	\$10.77	See Web for Volume Pricing	68
		Crimp/Solder	RG55, RG142, RG223, RG400, RG141	<a href="#">PE4008</a>	\$12.35		69
			RG58, RG303, RG141, PE-C195, PE-P195, LMR-195, .195 inch	<a href="#">PE4215</a>	\$11.93		70
			RG59*, RG62*, RG71	<a href="#">PE4294</a>	\$26.04		71
			RG178, RG196	<a href="#">PE4398</a>	\$19.64		72
			RG188-DS, RG316-DS	<a href="#">PE4401</a>	\$5.86		73
			PE-P195	<a href="#">PE44203</a>	\$17.50		74
			PE-C195, PE-P195, RG58, RG141, RG303, LMR-195, .195 inch	<a href="#">PE44460</a>	\$75.89		75
			RG142, RG223, RG400, RG55	<a href="#">PE44461</a>	\$60.99		76
			PE-C240, RG8X, .240 inch, LMR-240, LMR-240-DB, LMR-240-UF, B7808A	<a href="#">PE44637</a>	\$19.54		77
			PE-C400, PE-B400, PE-B405, LMR-400, LMR-400-DB, LMR-400-UF, .400 inch	<a href="#">PE44668</a>	\$28.65		78
			LMR-200, PE-C200	<a href="#">PE45040</a>	\$7.32		79
			RG174, RG316, RG188	<a href="#">PE45145</a>	\$12.34		80
			PE-B150, RG180, RG195	<a href="#">PE4578</a>	\$24.97		81
			LMR-100, PE-C100, RG174, RG188, RG316	<a href="#">TC-100-SM</a>	\$12.25		82
	LMR-195, PE-C195	<a href="#">TC-195-SM-SS-X</a>	\$15.25	83			
	LMR-200, PE-C200	<a href="#">TC-200-SM-SS-X</a>	\$14.00	84			
	LMR-240, PE-C240, LMR-240-UF	<a href="#">TC-240-SM-SS-X</a>	\$10.00	85			
	LMR-400, PE-C400	<a href="#">TC-400-SM-X</a>	\$13.75	86			
	Cable Connectors		Crimp/Solder (Captive Contact)	RG55, RG141, RG142, RG223, RG400	<a href="#">PE4576</a>		\$28.88
RG58				<a href="#">PE4577</a>	\$24.24	88	
RG174, RG316, RG188, LMR-100, PE-B100, PE-C100, .100 inch				<a href="#">PE4589</a>	\$18.55	89	
PCB Mount		Clamp	Vertical Launch	<a href="#">PE45460</a>	\$37.61	90	
			Vertical Launch	<a href="#">PE45461</a>	\$39.08	91	
Cable Connectors		Clamp/Solder	RG174, RG316, RG188, PE-B100, PE-C100, .100 inch, LMR-100	<a href="#">PE4026</a>	\$29.24	See Web for Volume Pricing	92
			RG55, RG58, RG141, RG142, RG223, RG303, RG400, PE-C195, PE-P195, LMR-195	<a href="#">PE4027</a>	\$28.19		93
			RG178, RG196	<a href="#">PE4214</a>	\$53.36		94
			RG213, RG214, RG8, RG9, RG11*, RG225, RG393, RG144*, RG216*, RG215	<a href="#">PE4332</a>	\$83.77		95
			RG180, RG195, PE-B150	<a href="#">PE4399</a>	\$23.31		96
			RG188-DS, RG316-DS	<a href="#">PE4400</a>	\$30.89		97
			PE-SR401AL, PE-SR401FL, RG401	<a href="#">PE4403</a>	\$42.34		98
			PE-P300LL	<a href="#">PE44808</a>	\$60.91		99
			PE-P142LL	<a href="#">PE44826</a>	\$38.86		1
			PE-P300LL	<a href="#">PE45042</a>	\$65.13		2
	RG58, RG303, LMR-195, PE-P195	<a href="#">PE45140</a>	\$22.73	3			
	RG316, RG174, LMR-100	<a href="#">PE45142</a>	\$14.46	4			
	PE-P160LL	<a href="#">PE45440</a>	\$77.42	5			
	PE-SR405AL, PE-SR405FL, RG405	<a href="#">PE4005</a>	\$7.72	6			
	RG174, RG316, RG188, LMR-100, PE-B100, PE-C100, .100 inch	<a href="#">PE4036</a>	\$13.75	7			
	RG58, RG55, RG142, RG223, RG400	<a href="#">PE4037</a>	\$15.44	8			
	PE-SR402AL, PE-SR402FL, PE-SR402FLJ, PE-SR402TN, RG402	<a href="#">PE4112</a>	\$10.42	9			
	RG178, RG196	<a href="#">PE4213</a>	\$18.30	10			
	RG188-DS, RG316-DS	<a href="#">PE4402</a>	\$16.74	11			
	PE-047SR, PE-SR047AL, PE-SR047FL	<a href="#">PE4404</a>	\$27.52	12			
PE-SR405AL, PE-SR405FL, PE-SR405FLJ, PE-SR405TN, RG405	<a href="#">PE44690</a>	\$9.90	13				
PE-047SR, PE-SR047AL, PE-SR047FL	<a href="#">PE44757</a>	\$34.91	14				
RG405, PE-SR405FL, PE-SR405FLJ	<a href="#">PE45135</a>	\$9.06	15				
SPP-250-LLPL	<a href="#">PE45543</a>	\$13.89	16				
PE-SR401AL, PE-SR401FL, RG401	<a href="#">PE4907</a>	\$44.07	17				
PE-034SR	<a href="#">PE4917</a>	\$81.80	18				
PE-020SR	<a href="#">PE4918</a>	\$45.63	19				

**Connectors**

See Our Website For Current Pricing & Real-Time Stock Availability!

\* Fits MIL-C-17 and equivalent cable versions only



















Technical Support  
+1 (949) 261-1920

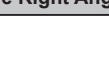

Same-Day Shipping,  
Even Custom  
Cable Assemblies

# SMA Connectors

Connection Method	Product Image	Attachment Cable/Contact	Coax Type / Termination Type	Model No.	PRICE			ROW
					1 Pc.	See Web for Volume Pricing		
<b>Male</b>								
Cable Connectors		Solder/Solder	SPP-250-LLPL	<a href="#">TC-SPP250-SM-LP</a>	\$6.90	See Web for Volume Pricing		20
		Solder (Without Contact)	PE-SR402AL, PE-SR402FL, PE-SR402FLJ, PE-SR402TN, RG402	<a href="#">PE4007</a>	\$10.23			21
		Solder/Solder (Captive Contact)	RG58, RG55, RG142, RG223, RG400	<a href="#">PE4587</a>	\$21.53			22
		Solder	PE-SR402AL, PE-SR402FL, PE-SR402FLJ, PE-SR402TN, RG402	<a href="#">PE44691</a>	\$10.15			25
			RG405, RG405 Tinned	<a href="#">PE45480</a>	\$38.66			27
	RG405, RG405 Tinned		<a href="#">PE45481</a>	\$38.66	28			
	.042 inch End Launch		<a href="#">PE44210</a>	\$33.80	24			
PCB Mount		Solder	Thru Hole with .200 inch x .067 inch Hole Spacing	<a href="#">PE4525</a>	\$23.33			26
			.062 inch End Launch	<a href="#">PE4912</a>	\$32.00			29
			.062 inch End Launch	<a href="#">PE4913</a>	\$32.87			30
Cable Connectors		Crimp/Non-Solder Contact	LMR-240, PE-C240	<a href="#">EZ-240-SM-X</a>	\$9.65			31
<b>Male, Bulkhead Mount</b>								
Terminal		Solder	Solder Cup with .235 inch D Hole	<a href="#">PE4354</a>	\$20.23			32
			Stub with .250 inch Diameter	<a href="#">PE4531</a>	\$40.03			33
			Solder Cup with .350 inch D Hole	<a href="#">PE4544</a>	\$19.03			34
<b>Male, 2 Hole Flange Mount</b>								
Terminal		Solder	Solder Cup with .481 inch Hole Spacing	<a href="#">PE4125</a>	\$29.82	See Web for Volume Pricing		35
			Stub with .481 inch Hole Spacing	<a href="#">PE4127</a>	\$14.41			36
			Solder Cup	<a href="#">PE45139</a>	\$10.02			37
Field Replaceable		Field Replaceable	.036 inch Pin	<a href="#">PE44032</a>	\$18.69			38
<b>Male, 4 Hole Flange Mount</b>								
Terminal		Solder	Stub with .340 inch Hole Spacing	<a href="#">PE4126</a>	\$24.89			39
			Solder Cup with .340 inch Hole Spacing	<a href="#">PE45204</a>	\$51.75			40
			Pin with .340 inch Hole Spacing	<a href="#">PE4541</a>	\$54.89			41
Field Replaceable		Field Replaceable	.012 inch Pin	<a href="#">PE44005</a>	\$37.73			42
			.018 inch Pin	<a href="#">PE44007</a>	\$22.98			43
			.020 inch Pin	<a href="#">PE44008</a>	\$39.20			44
			.036 inch Pin	<a href="#">PE44009</a>	\$23.43			45
			.012 inch Pin	<a href="#">PE44018</a>	\$27.34			46
			.015 inch Pin	<a href="#">PE44019</a>	\$45.31			47
			.018 inch Pin	<a href="#">PE44020</a>	\$37.73			48
			.020 inch Pin	<a href="#">PE44021</a>	\$23.88			49
<b>Male Right Angle</b>								
Cable Connectors		Crimp/Solder	RG55, RG142, RG223, RG400, RG141	<a href="#">PE4002</a>	\$18.51	See Web for Volume Pricing		50
			RG174, RG316, RG188, LMR-100, PE-B100, PE-C100, .100 inch	<a href="#">PE4009</a>	\$21.47			51
			RG178, RG196	<a href="#">PE4296</a>	\$28.39			52
			RG59*, RG62*, RG71	<a href="#">PE4327</a>	\$35.14			53
			RG58, RG303, RG141, PE-C195, PE-P195, LMR-195, .195 inch	<a href="#">PE4405</a>	\$11.67			54
			RG188-DS, RG316-DS	<a href="#">PE4408</a>	\$19.17			55
		Clamp/Solder	PE-C240, RG8X, .240 inch, LMR-240, LMR-240-DB, LMR-240-UF, B7808A	<a href="#">PE44638</a>	\$28.42			56
			PE-B150, RG180, RG195	<a href="#">PE4580</a>	\$24.11			57
			RG174, RG316, RG188, .100 inch, PE-B100, PE-C100, LMR-100	<a href="#">PE4028</a>	\$34.13			58
			RG178, RG196	<a href="#">PE4108</a>	\$20.84			59
			RG188-DS, RG316-DS	<a href="#">PE4407</a>	\$43.47			60
			PE-P142LL	<a href="#">PE44817</a>	\$123.42			61
			PE-SR402AL, PE-SR402FL, PE-SR402FLJ, PE-SR402TN, RG402	<a href="#">PE44996</a>	\$96.08			62
PE-P300LL	<a href="#">PE45041</a>	\$126.54	63					

\* Fits MIL-C-17 and equivalent cable versions only

Connectors

See Our Website For Current Pricing & Real-Time Stock Availability!

# SMA Connectors

Connection Method	Product Image	Attachment Cable/Contact	Coax Type / Termination Type	Model No.	PRICE		ROW
					1 Pc.	See Web for Volume Pricing	
<b>Male Right Angle</b>							
Cable Connectors		Clamp/Solder	RG58, RG55, RG141, RG142, RG223, RG303, RG400, LMR-195, PE-C195	<a href="#">PE45048</a>	\$50.08	See Web for Volume Pricing	64
			PE-P160LL	<a href="#">PE45442</a>	\$113.13		65
			RG180, RG195	<a href="#">PE4579</a>	\$25.43		66
		Solder/Solder	PE-SR405AL, PE-SR405FL, RG405	<a href="#">PE4025</a>	\$30.18		67
			RG316, RG174, RG188, LMR-100, PE-B100, PE-C100, .100 inch	<a href="#">PE4038</a>	\$19.97		68
			RG58, RG55, RG142, RG223, RG400	<a href="#">PE4039</a>	\$18.47		69
			PE-SR402AL, PE-SR402FL, PE-SR402FLJ, PE-SR402TN, RG402	<a href="#">PE4083</a>	\$21.64		70
			RG178, RG196	<a href="#">PE4406</a>	\$24.64		71
			RG188-DS, RG316-DS	<a href="#">PE4409</a>	\$22.87		72
			PE-SR405AL, PE-SR405FL, PE-SR405FLJ, PE-SR405TN, RG405	<a href="#">PE44692</a>	\$12.02		73
			PE-SR402AL, PE-SR402FL, PE-SR402FLJ, PE-SR402TN, RG402	<a href="#">PE44693</a>	\$11.60		74
			PE-047SR, PE-SR047AL, PE-SR047FL	<a href="#">PE45282</a>	\$60.56		75
			SPP-250-LLPL	<a href="#">PE45434</a>	\$15.29		76
			PE-034SR	<a href="#">PE4919</a>	\$59.91		77
			PE-020SR	<a href="#">PE4920</a>	\$66.44		78
			PE-SR401AL, PE-SR401FL, RG401	<a href="#">PE4932</a>	\$60.86		79
SPP-250-LLPL	<a href="#">TC-SPP250-SM-RA-LP</a>	\$11.50	80				
PCB Mount		Solder	Thru Hole with .200 inch x .067 inch Hole Spacing	<a href="#">PE4526</a>	\$45.13		81
Cable Connectors		Crimp/Non-Solder Contact	LMR-240	<a href="#">EZ-240-SM-RA-X</a>	\$12.75		82
<b>Female</b>							
Cable Connectors		Crimp/Solder	RG178, RG196	<a href="#">PE4325</a>	\$28.72	See Web for Volume Pricing	83
			RG59*, RG62*	<a href="#">PE4326</a>	\$28.28		84
			RG55, RG142, RG223	<a href="#">PE4412</a>	\$17.55		85
			RG58, RG303, RG141, PE-C195, PE-P195, LMR-195	<a href="#">PE4413</a>	\$17.90		86
			RG174, RG316, RG188, .100 inch, PE-B100, PE-C100, LMR-100	<a href="#">PE4414</a>	\$19.86		87
			RG188-DS, RG316-DS	<a href="#">PE4416</a>	\$19.69		88
			PE-C240, RG8X, .240 inch, LMR-240, LMR-240-DB, LMR-240-UF, B7808A	<a href="#">PE44639</a>	\$24.01		89
			PE-C400, PE-B400, PE-B405, LMR-400, LMR-400-DB, LMR-400-UF, .400 inch	<a href="#">PE44669</a>	\$47.64		90
PCB Mount		Clamp	Vertical Launch	<a href="#">PE45137</a>	\$9.13		91
			Vertical Launch	<a href="#">PE45458</a>	\$36.52		92
Cable Connectors		Clamp/Solder	RG316, RG174, RG188, PE-B100, PE-C100, .100 inch, LMR-100	<a href="#">PE4030</a>	\$33.30	See Web for Volume Pricing	94
			RG55, RG58, RG141, RG142, RG223, RG303, RG400, PE-C195, PE-P195, LMR-195	<a href="#">PE4031</a>	\$44.47		95
			RG213, RG214, RG8, RG9, RG11*, RG225, RG393	<a href="#">PE4411</a>	\$62.79		96
			RG188-DS, RG316-DS	<a href="#">PE4415</a>	\$32.87		97
			PE-P142LL	<a href="#">PE44814</a>	\$68.57		98
PCB Mount		Clamp/Solder (Captive Contact)	End Launch	<a href="#">PE4591</a>	\$29.29	See Web for Volume Pricing	99
			End Launch	<a href="#">PE45462</a>	\$52.01		1
			End Launch	<a href="#">PE45463</a>	\$52.01		2
			End Launch	<a href="#">PE45464</a>	\$52.01		3
			End Launch	<a href="#">PE45465</a>	\$52.01		4
Cable Connectors		Solder/Solder	RG316, RG174, RG188	<a href="#">PE45466</a>	\$50.06	See Web for Volume Pricing	5
			RG58, RG55, RG142, RG223, RG400	<a href="#">PE4040</a>	\$15.64		6
			PE-SR402AL, PE-SR402FL, PE-SR402FLJ, PE-SR402TN, RG402	<a href="#">PE4041</a>	\$17.20		7
			PE-SR405AL, PE-SR405FL, PE-SR405FLJ, RG405	<a href="#">PE4115</a>	\$17.63		8
			RG188-DS, RG316-DS	<a href="#">PE4116</a>	\$22.88		9
			RG178, RG196	<a href="#">PE4417</a>	\$14.98		10
PE-047SR, PE-SR047AL, PE-SR047FL	<a href="#">PE4418</a>	\$38.96	11				
PE-SR405AL, PE-SR405FL, PE-SR405FLJ, PE-SR405TN, RG405	<a href="#">PE44694</a>	\$8.52	12				

Connectors

See Our Website For Current Pricing & Real-Time Stock Availability!

\* Fits MIL-C-17 and equivalent cable versions only











Technical Support  
+1 (949) 261-1920



Same-Day Shipping,  
Even Custom  
Cable Assemblies

# SMA Connectors











Connection Method	Product Image	Attachment Cable/Contact	Coax Type / Termination Type	Model No.	PRICE				ROW		
					1-24	25-49	50-99	100 +			
<b>Female</b>											
Cable Connectors		Solder/Solder	PE-SR402AL, PE-SR402FL, PE-SR402FLJ, PE-SR402TN, RG402	<a href="#">PE44695</a>	\$9.55	\$9.07	\$8.60	\$8.21	13		
			SPP-250-LLPL	<a href="#">PE45432</a>	\$14.59	\$13.86	\$13.13	\$12.55	14		
			RG178, RG196	<a href="#">PE4592</a>	\$25.71	\$24.42	\$23.14	\$22.11	15		
			PE-034SR	<a href="#">PE4921</a>	\$59.91	\$56.91	\$53.92	\$51.52	16		
			PE-020SR	<a href="#">PE4922</a>	\$65.26	\$62.00	\$58.73	\$56.12	17		
			PE-SR401AL, PE-SR401FL, RG401	<a href="#">PE4930</a>	\$29.92	\$28.42	\$26.93	\$25.73	18		
PCB Mount		Solder/Solder (Captive Contact)	1/8 inch Stripline	<a href="#">PE4190</a>	\$46.56	\$44.23	\$41.90	\$40.04	19		
			1/16 inch Stripline	<a href="#">PE4534</a>	\$44.25	\$42.04	\$39.83	\$38.06	20		
		Solder	Thru Hole with .200 inch x .067 inch Hole Spacing	<a href="#">PE4117</a>	\$14.39	\$13.67	\$12.95	\$12.38	21		
			.042 inch End Launch	<a href="#">PE44204</a>	\$25.42	\$24.15	\$22.88	\$21.86	22		
			.047 inch End Launch	<a href="#">PE44205</a>	\$29.06	\$27.61	\$26.15	\$24.99	23		
			.031 inch End Launch	<a href="#">PE44206</a>	\$20.52	\$19.49	\$18.47	\$17.65	24		
			.042 inch End Launch	<a href="#">PE44207</a>	\$27.13	\$25.77	\$24.42	\$23.33	25		
			.047 inch End Launch	<a href="#">PE44208</a>	\$28.24	\$26.83	\$25.42	\$24.29	26		
			End Launch	<a href="#">PE44235</a>	\$22.93	\$21.78	\$20.64	\$19.72	27		
			.078 inch End Launch	<a href="#">PE44614</a>	\$34.64	\$32.91	\$31.18	\$29.79	28		
			Thru Hole with .200 inch x .067 inch Hole Spacing	<a href="#">PE44827</a>	\$10.85	\$10.31	\$9.77	\$9.33	29		
			.062 inch End Launch	<a href="#">PE4542</a>	\$18.73	\$17.79	\$16.86	\$16.11	30		
			.062 inch End Launch	<a href="#">PE4543</a>	\$20.03	\$19.03	\$18.03	\$17.23	31		
			Surface Mount	<a href="#">PE4910</a>	\$17.00	\$16.15	\$15.30	\$14.62	32		
<b>Female, Bulkhead Mount</b>											
Cable Connectors		Crimp/Solder	RG55, RG142, RG223, RG141 with .235 inch D Hole	<a href="#">PE4419</a>	\$21.64	\$20.56	\$19.48	\$18.61	33		
			RG58 with .235 inch D Hole	<a href="#">PE4420</a>	\$19.17	\$18.21	\$17.25	\$16.49	34		
			RG178, RG196 with .235 inch D Hole	<a href="#">PE4422</a>	\$24.70	\$23.47	\$22.23	\$21.24	35		
			RG188-DS, RG316-DS with .235 inch D Hole	<a href="#">PE4425</a>	\$22.35	\$21.23	\$20.12	\$19.22	36		
			RG316, RG174, RG188, PE-B100, PE-C100, .100 inch, LMR-100 with .235 inch D Hole	<a href="#">PE4427</a>	\$15.89	\$15.10	\$14.30	\$13.67	37		
			RG174, RG316, RG188, .100 inch, PE-B100, PE-C100, LMR-100 with .235 inch D Hole	<a href="#">PE44643</a>	\$22.52	\$21.39	\$20.27	\$19.37	38		
			RG316, RG174, LMR-100	<a href="#">PE45136</a>	\$15.55	\$14.77	\$14.00	\$13.37	39		
			RG58, RG303, LMR-195	<a href="#">PE45138</a>	\$11.08	\$10.53	\$9.97	\$9.53	40		
			RG58, RG303, LMR-195, PE-P195	<a href="#">PE45141</a>	\$12.48	\$11.86	\$11.23	\$10.73	41		
			RG178, RG196 with .235 inch D Hole	<a href="#">PE45292</a>	\$19.75	\$18.76	\$17.78	\$16.99	42		
		Clamp/Solder	RG59*, RG62*, RG71 with .235 inch D Hole	<a href="#">PE4914</a>	\$26.17	\$24.86	\$23.55	\$22.51	43		
			RG316, RG174, RG188, PE-B100, PE-C100, .100 inch, LMR-100 with .235 inch D Hole	<a href="#">PE4032</a>	\$34.07	\$32.37	\$30.66	\$29.30	44		
			RG58, RG142, RG223, RG400, RG141, RG303, RG55, LMR-400, PE-C195, PE-P195 with .235 inch D Hole	<a href="#">PE4033</a>	\$39.62	\$37.64	\$35.66	\$34.07	45		
			RG178, RG196 with .235 inch D Hole	<a href="#">PE4421</a>	\$38.53	\$36.60	\$34.68	\$33.14	46		
			RG188-DS, RG316-DS with .235 inch D Hole	<a href="#">PE4424</a>	\$41.17	\$39.11	\$37.05	\$35.41	47		
			PE-P160LL	<a href="#">PE45441</a>	\$93.78	\$89.09	\$84.40	\$80.65	48		
				Solder/Solder	PE-SR405AL, PE-SR405FL, RG405 with .235 inch D Hole	<a href="#">PE4119</a>	\$15.14	\$14.38	\$13.63	\$13.02	49
					RG316, RG174, RG188 with .235 inch D Hole	<a href="#">PE4188</a>	\$17.81	\$16.92	\$16.03	\$15.32	50
					RG58, RG55, RG142, RG223 with .235 inch D Hole	<a href="#">PE4353</a>	\$19.29	\$18.33	\$17.36	\$16.59	51
					RG178, RG196 with .235 inch D Hole	<a href="#">PE4423</a>	\$24.31	\$23.09	\$21.88	\$20.91	52
RG188-DS, RG316-DS with .235 inch D Hole	<a href="#">PE4426</a>	\$20.50			\$19.48	\$18.45	\$17.63	53			
PE-SR405AL, PE-SR405FL, PE-SR405FLJ, PE-SR405TN, RG405	<a href="#">PE44696</a>	\$12.36			\$11.74	\$11.12	\$10.63	54			
PE-SR402AL, PE-SR402FL, PE-SR402FLJ, PE-SR402TN, RG402	<a href="#">PE44697</a>	\$11.10			\$10.55	\$9.99	\$9.55	55			
PE-SR402AL, PE-SR402FL, PE-SR402FLJ, PE-SR402TN, RG402 with .235 inch D Hole	<a href="#">PE45554</a>	\$16.59			\$15.76	\$14.93	\$14.27	56			
PE-034SR with .235 inch D Hole	<a href="#">PE4923</a>	\$68.32			\$64.90	\$61.49	\$58.76	57			
PE-020SR with .235 inch D Hole	<a href="#">PE4924</a>	\$65.71			\$62.42	\$59.14	\$56.51	58			
Terminal		Solder	Solder Cup with .235 inch D Hole	<a href="#">PE4101</a>	\$17.64	\$16.76	\$15.88	\$15.17	60		
			Stub with .250 inch Diameter	<a href="#">PE4189</a>	\$16.50	\$15.68	\$14.85	\$14.19	61		
PCB Mount		Solder	Solder Cup with .235 inch D Hole	<a href="#">PE4219</a>	\$14.88	\$14.14	\$13.39	\$12.80	62		
			.042 inch End Launch with .250 inch Diameter	<a href="#">PE44211</a>	\$27.56	\$26.18	\$24.80	\$23.70	63		
			.062 inch End Launch with .250 inch Diameter	<a href="#">PE44212</a>	\$25.05	\$23.80	\$22.55	\$21.54	64		
			.042 inch End Launch with .250 inch Diameter	<a href="#">PE44213</a>	\$25.11	\$23.85	\$22.60	\$21.59	65		
			.062 inch End Launch with .250 inch Diameter	<a href="#">PE44214</a>	\$26.56	\$25.23	\$23.90	\$22.84	66		

\* Fits MIL-C-17 and equivalent cable versions only

Connectors

See Our Website For Current Pricing & Real-Time Stock Availability!

# SMA Connectors







Connection Method	Product Image	Attachment Cable/Contact	Coax Type / Termination Type	Model No.	PRICE				ROW
					1-24	25-49	50-99	100 +	
<b>Female, Bulkhead Mount</b>									
Terminal		Solder	Stub with .250 inch Diameter	<a href="#">PE44591</a>	\$30.04	\$28.54	\$27.04	\$25.83	67
PCB Mount			End Launch	<a href="#">PE45134</a>	\$24.16	\$22.95	\$21.74	\$20.78	68
			Thru Hole with .235 inch D Hole	<a href="#">PE4524</a>	\$19.43	\$18.46	\$17.49	\$16.71	69
Terminal			Stub with .235 inch D Hole	<a href="#">PE4528</a>	\$40.51	\$38.48	\$36.46	\$34.84	70
			Solder Cup with .235 inch D Hole	<a href="#">PE4529</a>	\$49.66	\$47.18	\$44.69	\$42.71	71
			Stub with .250 inch Diameter	<a href="#">PE4530</a>	\$34.93	\$33.18	\$31.44	\$30.04	72
			Stub with .250 inch Diameter	<a href="#">PE4532</a>	\$28.55	\$27.12	\$25.70	\$24.55	73
			Solder Cup with .350 inch D Hole	<a href="#">PE4536</a>	\$42.59	\$40.46	\$38.33	\$36.63	74
			Solder Cup with .250 inch Diameter	<a href="#">PE4549</a>	\$29.56	\$28.08	\$26.60	\$25.42	75
<b>Female, 2 Hole Flange Mount</b>									
Cable Connectors		Solder/Solder	PE-SR402AL, PE-SR402FL, RG402 with .481 inch Hole Spacing	<a href="#">PE4196</a>	\$26.46	\$25.14	\$23.81	\$22.76	76
			PE-SR405AL, PE-SR405FL, PE-SR405FLJ, RG405 with .481 inch Hole Spacing	<a href="#">PE4197</a>	\$24.22	\$23.01	\$21.80	\$20.83	77
			PE-047SR, PE-SR047AL, PE-SR047FL with .481 inch Hole Spacing	<a href="#">PE4547</a>	\$27.53	\$26.15	\$24.78	\$23.68	78
Terminal		Solder	Solder Cup with .481 inch Hole Spacing	<a href="#">PE4004</a>	\$16.98	\$16.13	\$15.28	\$14.60	79
			Stub with .481 inch Hole Spacing	<a href="#">PE4128</a>	\$19.67	\$18.69	\$17.70	\$16.92	80
			Stub with .481 inch Hole Spacing	<a href="#">PE4128-SF</a>	\$17.94	\$17.04	\$16.15	\$15.43	81
			Tab with .481 inch Hole Spacing	<a href="#">PE4370</a>	\$24.62	\$23.39	\$22.16	\$21.17	82
			Solder Cup with .481 inch Hole Spacing	<a href="#">PE44341</a>	\$60.41	\$57.39	\$54.37	\$51.95	83
			Stub	<a href="#">PE45039</a>	\$16.36	\$15.71	\$15.21	\$14.89	84
			Stub	<a href="#">PE45067</a>	\$16.11	\$15.30	\$14.50	\$13.85	85
Field Replaceable		Field Replaceable	.015 inch Pin	<a href="#">PE44024</a>	\$33.23	\$31.57	\$29.91	\$28.58	86
			.018 inch Pin	<a href="#">PE44025</a>	\$36.74	\$34.90	\$33.07	\$31.60	87
			.036 inch Pin	<a href="#">PE45055</a>	\$29.09	\$27.64	\$26.18	\$25.02	88
			.012 inch Pin	<a href="#">PE45217</a>	\$29.67	\$28.19	\$26.70	\$25.52	89
Terminal		Compression	Stub with .481 inch Hole Spacing	<a href="#">PE44340</a>	\$63.25	\$60.09	\$56.93	\$54.40	90
<b>Female, 4 Hole Flange Mount</b>									
Cable Connectors		Clamp/Solder	.100 inch, RG316, RG174, RG188, LMR-100, LMR-100A, LMR-100A-FR, PE-C100, PE-B100 with .340 inch Hole Spacing	<a href="#">PE4034</a>	\$58.67	\$55.74	\$52.80	\$50.46	91
			Solder/Solder	RG402, RG402 Tinned, PE-SR402FL, PE-SR402AL, PE-SR402FLJ, PE-SR402TN with .340 inch Hole Spacing	<a href="#">PE4121</a>	\$37.48	\$35.61	\$33.73	\$32.23
	Solder/Solder	RG405, RG405 Tinned, PE-SR405FL, PE-SR405AL, PE-SR405FLJ, PE-SR405TN		<a href="#">PE44998</a>	\$31.29	\$29.73	\$28.16	\$26.91	93
		PE-047SR, PE-SR047AL, PE-SR047FL with .340 inch Hole Spacing	<a href="#">PE4548</a>	\$43.44	\$41.27	\$39.10	\$37.36	94	
Terminal		Solder	Solder Cup with .340 inch Hole Spacing	<a href="#">PE4000</a>	\$22.39	\$21.27	\$20.15	\$19.26	95
			Stub with .340 inch Hole Spacing	<a href="#">PE4099</a>	\$19.54	\$18.56	\$17.59	\$16.80	96
			Tab with .340 inch Hole Spacing	<a href="#">PE4186</a>	\$20.98	\$19.93	\$18.88	\$18.04	97
			Pin with .340 inch Hole Spacing	<a href="#">PE4217</a>	\$25.42	\$24.15	\$22.88	\$21.86	98
			Solder Cup with .718 inch Hole Spacing	<a href="#">PE4218</a>	\$28.38	\$26.96	\$25.54	\$24.41	99
			Solder Cup with .500 inch Hole Spacing	<a href="#">PE4527</a>	\$27.56	\$26.18	\$24.80	\$23.70	1
			Stub with .500 inch Hole Spacing	<a href="#">PE4533</a>	\$26.06	\$24.76	\$23.45	\$22.41	2
			Solder Cup with .340 inch Hole Spacing	<a href="#">PE4537</a>	\$32.20	\$30.59	\$28.98	\$27.69	3
			Pin with .375 inch x .500 inch Hole Spacing	<a href="#">PE4538</a>	\$41.99	\$39.89	\$37.79	\$36.11	4
			Tab with .375 inch x .500 inch Hole Spacing	<a href="#">PE4539</a>	\$32.20	\$30.59	\$28.98	\$27.69	5
Pin with .340 inch Hole Spacing	<a href="#">PE4540</a>	\$50.62	\$48.09	\$45.56	\$43.53	6			
Field Replaceable		Field Replaceable	.012 inch Pin	<a href="#">PE44000</a>	\$38.28	\$36.37	\$34.45	\$32.92	7
			.015 inch Pin	<a href="#">PE44001</a>	\$35.44	\$33.67	\$31.90	\$30.48	8
			.020 inch Pin	<a href="#">PE44003</a>	\$35.80	\$34.01	\$32.22	\$30.79	9
			.036 inch Pin	<a href="#">PE44004</a>	\$38.28	\$36.37	\$34.45	\$32.92	10
			.012 inch Pin	<a href="#">PE44010</a>	\$36.57	\$34.74	\$32.91	\$31.45	11
			.036 inch Pin	<a href="#">PE45053</a>	\$31.86	\$30.27	\$28.67	\$27.40	12
			.020 inch Pin	<a href="#">PE45215</a>	\$19.72	\$18.73	\$17.75	\$16.96	13
.015 inch Pin	<a href="#">PE45216</a>	\$22.10	\$21.00	\$19.89	\$19.01	14			

Connectors





See Our Website For Current Pricing & Real-Time Stock Availability!

\* Fits MIL-C-17 and equivalent cable versions only

## SMA Connectors

Connection Method	Product Image	Attachment Cable/Contact	Coax Type / Termination Type	Model No.	PRICE				ROW
					1-24	25-49	50-99	100 +	
<b>Female, Press-In</b>									
Terminal		Solder	Tab with .200 inch Diameter	<a href="#">PE44240</a>	\$28.77	\$27.33	\$25.89	\$24.74	15
			Tab with .200 inch Diameter	<a href="#">PE44241</a>	\$31.80	\$30.21	\$28.62	\$27.35	16
<b>Female Right Angle</b>									
PCB Mount		Solder	Thru Hole with .200 inch x .067 inch Hole Spacing	<a href="#">PE4118</a>	\$20.90	\$19.86	\$18.81	\$17.97	17
			Surface Mount	<a href="#">PE4911</a>	\$28.28	\$26.87	\$25.45	\$24.32	18
<b>Female Right Angle, Bulkhead Mount</b>									
Terminal		Solder	Solder Cup with .235 inch D Hole	<a href="#">PE4300</a>	\$53.70	\$51.02	\$48.33	\$46.18	19
PCB Mount			Thru Hole with .235 inch D Hole	<a href="#">PE4545</a>	\$28.86	\$27.42	\$25.97	\$24.82	20
<b>Female Right Angle, 2 Hole Flange Mount</b>									
Terminal		Solder	Pin with .481 inch Hole Spacing	<a href="#">PE44237</a>	\$54.06	\$51.36	\$48.65	\$46.49	21
			Pin with .481 inch Hole Spacing	<a href="#">PE44238</a>	\$50.77	\$48.23	\$45.69	\$43.66	22
			Pin with .481 inch Hole Spacing	<a href="#">PE44239</a>	\$51.92	\$49.32	\$46.73	\$44.65	23
			Pin with .481 inch Hole Spacing	<a href="#">PE44593</a>	\$50.77	\$48.23	\$45.69	\$43.66	24
<b>Female Right Angle, 4 Hole Flange Mount</b>									
Terminal		Solder	Solder Cup with .340 inch Hole Spacing	<a href="#">PE4123</a>	\$38.33	\$36.41	\$34.50	\$32.96	25
			Pin with .340 inch Hole Spacing	<a href="#">PE44236</a>	\$34.04	\$32.34	\$30.64	\$29.27	26
Field Replaceable		Field Replaceable	.012 inch Pin	<a href="#">PE44015</a>	\$57.89	\$55.00	\$52.10	\$49.79	27

## Reverse Polarity SMA Connectors

Connection Method	Product Image	Attachment Cable/Contact	Coax Type / Termination Type	Model No.	PRICE				ROW
					1-24	25-49	50-99	100 +	
<b>Male</b>									
Cable Connectors		Crimp/Solder	PE-C240, RG8X, .240 inch, LMR-240, LMR-240-DB, LMR-240-UF, B7808A	<a href="#">PE44664</a>	\$24.89	\$23.65	\$22.40	\$21.41	28
			PE-C400, PE-B400, PE-B405, LMR-400, LMR-400-DB, LMR-400-UF, .400 inch	<a href="#">PE44666</a>	\$29.67	\$28.19	\$26.70	\$25.52	29
			RG188-DS, RG316-DS	<a href="#">PE45183</a>	\$18.47	\$17.55	\$16.62	\$15.88	30
			RG55, RG141, RG142, RG223, RG400	<a href="#">PE4767</a>	\$21.78	\$20.69	\$19.60	\$18.73	31
			RG58	<a href="#">PE4769</a>	\$21.87	\$20.78	\$19.68	\$18.81	32
			RG174, RG316, RG188, PE-B100, PE-C100, .100 inch, LMR-100	<a href="#">PE4771</a>	\$20.30	\$19.29	\$18.27	\$17.46	33
			PE-B150, RG180, RG195	<a href="#">PE4777</a>	\$14.83	\$14.09	\$13.35	\$12.75	34
		Clamp/Solder	RG55, RG58, RG141, RG142, RG223, RG303, RG400, PE-C195, PE-P195, LMR-195	<a href="#">PE4766</a>	\$33.75	\$32.06	\$30.38	\$29.03	35
			RG174, RG316, RG188, PE-B100, PE-C100, .100 inch, LMR-100	<a href="#">PE4770</a>	\$37.61	\$35.73	\$33.85	\$32.34	36
			RG178, RG196	<a href="#">PE4773</a>	\$12.93	\$12.28	\$11.64	\$11.12	37
		Solder/Solder	PE-SR402AL, PE-SR402FL, PE-SR402FLJ, PE-SR402TN, RG402	<a href="#">PE44724</a>	\$20.72	\$19.68	\$18.65	\$17.82	38
			RG58, RG55, RG141, RG142, RG223, RG400	<a href="#">PE4768</a>	\$21.82	\$20.73	\$19.64	\$18.77	39
			RG174, RG316, RG188	<a href="#">PE4772</a>	\$20.20	\$19.19	\$18.18	\$17.37	40
			RG178, RG196	<a href="#">PE4775</a>	\$25.80	\$24.77	\$23.99	\$23.48	41
			PE-SR405AL, PE-SR405FL, RG405	<a href="#">PE4779</a>	\$26.34	\$25.02	\$23.71	\$22.65	42
<b>Male Right Angle</b>									
Cable Connectors		Crimp/Solder	RG58, RG141, PE-C195, PE-P195	<a href="#">PE45012</a>	\$34.11	\$32.40	\$30.70	\$29.33	43
			RG188-DS, RG316-DS	<a href="#">PE45185</a>	\$42.95	\$40.80	\$38.66	\$36.94	44
			RG174, RG316, RG188, PE-B100, PE-C100, .100 inch, LMR-100	<a href="#">PE4785</a>	\$54.93	\$52.18	\$49.44	\$47.24	45
			RG178, RG196	<a href="#">PE4788</a>	\$37.73	\$35.84	\$33.96	\$32.45	46
			RG55, RG142, RG223, RG400	<a href="#">PE44975</a>	\$39.57	\$37.59	\$35.61	\$34.03	47

\* Fits MIL-C-17 and equivalent cable versions only

# Reverse Polarity SMA Connectors

Connection Method	Product Image	Attachment Cable/Contact	Coax Type / Termination Type	Model No.	PRICE				ROW
					1-24	25-49	50-99	100 +	
<b>Male Right Angle</b>									
Cable Connectors		Clamp/Solder	RG58, RG55, RG141, RG142, RG223, RG400	<a href="#">PE4780</a>	\$40.75	\$38.71	\$36.68	\$35.05	48
			RG174, RG316, RG188	<a href="#">PE4784</a>	\$56.45	\$53.63	\$50.81	\$48.55	49
			RG178, RG196	<a href="#">PE4787</a>	\$77.56	\$74.46	\$72.13	\$70.58	50
		Solder/Solder	RG58, RG55, RG141, RG142, RG223, RG400	<a href="#">PE4782</a>	\$37.97	\$36.07	\$34.17	\$32.65	51
			RG174, RG316, RG188	<a href="#">PE4786</a>	\$37.97	\$36.07	\$34.17	\$32.65	52
			PE-SR402AL, PE-SR402FL, RG402	<a href="#">PE4790</a>	\$45.31	\$43.04	\$40.78	\$38.97	53
			PE-SR405AL, PE-SR405FL, PE-SR405FLJ, PE-SR405TN, RG405	<a href="#">PE4791</a>	\$47.79	\$45.40	\$43.01	\$41.10	54
<b>Female</b>									
Cable Connectors		Crimp/Solder	PE-C240, RG8X, .240 inch, LMR-240, LMR-240-DB, LMR-240-UF, B7808A	<a href="#">PE44665</a>	\$26.77	\$25.43	\$24.09	\$23.02	55
			RG188-DS, RG316-DS	<a href="#">PE45186</a>	\$28.08	\$26.68	\$25.27	\$24.15	56
			RG55, RG141, RG142, RG223, RG400	<a href="#">PE4793</a>	\$33.47	\$31.80	\$30.12	\$28.78	57
			RG58	<a href="#">PE4795</a>	\$26.86	\$25.52	\$24.17	\$23.10	58
			RG174, RG316, RG188, PE-B100, PE-C100, .100 inch, LMR-100, RG179	<a href="#">PE4797</a>	\$31.08	\$29.53	\$27.97	\$26.73	59
			RG178, RG196	<a href="#">PE4799</a>	\$30.42	\$28.90	\$27.38	\$26.16	60
		Clamp/Solder	RG55, RG58, RG141, RG142, RG223, RG303, RG400, PE-C195, PE-P195, LMR-195	<a href="#">PE4792</a>	\$32.59	\$30.96	\$29.33	\$28.03	61
			RG178, RG196	<a href="#">PE4850</a>	\$12.25	\$11.76	\$11.39	\$11.15	62
			PE-SR402AL, PE-SR402FL, PE-SR402FLJ, PE-SR402TN, RG402	<a href="#">PE44723</a>	\$26.18	\$24.87	\$23.56	\$22.51	63
		Solder/Solder	RG58, RG55, RG141, RG142, RG223, RG400	<a href="#">PE4794</a>	\$24.38	\$23.16	\$21.94	\$20.97	64
			RG174, RG316, RG188	<a href="#">PE4798</a>	\$26.86	\$25.52	\$24.17	\$23.10	65
			RG178, RG196	<a href="#">PE4851</a>	\$23.24	\$22.08	\$20.92	\$19.99	66
PE-SR402AL, PE-SR402FL, RG402			<a href="#">PE4852</a>	\$30.99	\$29.44	\$27.89	\$26.65	67	
PE-SR405AL, PE-SR405FL, PE-SR405FLJ, PE-SR405TN, RG405			<a href="#">PE4853</a>	\$17.05	\$16.20	\$15.35	\$14.66	68	
PCB Mount		Solder	Thru Hole with .200 inch x .067 inch Hole Spacing	<a href="#">PE4869</a>	\$24.61	\$23.38	\$22.15	\$21.16	69
			.062 inch End Launch	<a href="#">PE4874</a>	\$28.31	\$26.89	\$25.48	\$24.35	70
<b>Female, Bulkhead Mount</b>									
Cable Connectors		Crimp/Solder	RG196, RG178	<a href="#">PE45004</a>	\$17.63	\$16.92	\$16.40	\$16.04	71
			RG188-DS, RG316-DS with .235 inch D Hole	<a href="#">PE45189</a>	\$26.64	\$25.31	\$23.98	\$22.91	72
			RG55, RG141, RG142, RG223, RG400 with .235 inch D Hole	<a href="#">PE4855</a>	\$29.36	\$27.89	\$26.42	\$25.25	73
			RG58 with .235 inch D Hole	<a href="#">PE4857</a>	\$23.41	\$22.24	\$21.07	\$20.13	74
			.100 inch, RG316, RG174, RG188, LMR-100, LMR-100A, LMR-100A-FR, PE-C100, PE-B100 with .235 inch D Hole	<a href="#">PE4859</a>	\$29.26	\$27.80	\$26.33	\$25.16	75
			RG178, RG196 with .235 inch D Hole	<a href="#">PE4862</a>	\$25.64	\$24.36	\$23.08	\$22.05	76
		Clamp/Solder	RG58, RG142, RG223, RG400, RG141, RG303, RG55, LMR-195, PE-C195, PE-P195 with .235 inch D Hole	<a href="#">PE4854</a>	\$37.73	\$35.84	\$33.96	\$32.45	77
			RG174, RG316, RG188 with .235 inch D Hole	<a href="#">PE4858</a>	\$41.95	\$39.85	\$37.76	\$36.08	78
			RG178, RG196 with .235 inch D Hole	<a href="#">PE4861</a>	\$37.73	\$35.84	\$33.96	\$32.45	79
		Solder/Solder	RG58, RG55, RG141, RG142, RG223, RG400 with .235 inch D Hole	<a href="#">PE4856</a>	\$25.10	\$23.85	\$22.59	\$21.59	80
			RG174, RG316, RG188 with .235 inch D Hole	<a href="#">PE4860</a>	\$24.38	\$23.16	\$21.94	\$20.97	81
			RG178, RG196 with .235 inch D Hole	<a href="#">PE4863</a>	\$24.52	\$23.29	\$22.07	\$21.09	82
PE-SR402AL, PE-SR402FL, RG402 with .235 inch D Hole			<a href="#">PE4864</a>	\$35.60	\$33.82	\$32.04	\$30.62	83	
PE-SR405AL, PE-SR405FL, PE-SR405FLJ, PE-SR405TN, RG405 with .235 inch D Hole			<a href="#">PE4865</a>	\$40.23	\$38.22	\$36.21	\$34.60	84	
Terminal		Solder	Solder Cup with .235 inch D Hole	<a href="#">PE4868</a>	\$24.22	\$23.01	\$21.80	\$20.83	85
			Solder Cup with .235 inch D Hole	<a href="#">PE4871</a>	\$24.02	\$22.82	\$21.62	\$20.66	86
PCB Mount		Solder	Thru Hole with .250 inch Diameter	<a href="#">PE4872</a>	\$24.83	\$23.59	\$22.35	\$21.35	87
<b>Female, 2 Hole Flange Mount</b>									
Terminal		Solder	Solder Cup with .481 inch Hole Spacing	<a href="#">PE4867</a>	\$29.30	\$27.84	\$26.37	\$25.20	88

Connectors

See Our Website For Current Pricing & Real-Time Stock Availability!

\* Fits MIL-C-17 and equivalent cable versions only





Technical Support  
+1 (949) 261-1920









Same-Day Shipping,  
Even Custom  
Cable Assemblies

## Reverse Polarity SMA Connectors

Connection Method	Product Image	Attachment Cable/Contact	Coax Type / Termination Type	Model No.	PRICE				ROW
					1-24	25-49	50-99	100 +	
<b>Female, 4 Hole Flange Mount</b>									
Terminal		Solder	Solder Cup with .340 inch Hole Spacing	<a href="#">PE4866</a>	\$20.29	\$19.28	\$18.26	\$17.45	89
<b>Female Right Angle</b>									
PCB Mount		Solder	Thru Hole with .200 inch x .067 inch Hole Spacing	<a href="#">PE4870</a>	\$36.57	\$34.74	\$32.91	\$31.45	90
<b>Female Right Angle, Bulkhead Mount</b>									
PCB Mount		Solder	Thru Hole with .250 inch Diameter	<a href="#">PE4875</a>	\$48.52	\$46.09	\$43.67	\$41.73	91

## Reverse Thread SMA Connectors

Connection Method	Product Image	Attachment Cable/Contact	Coax Type / Termination Type	Model No.	PRICE				ROW
					1-24	25-49	50-99	100 +	
<b>Male</b>									
Cable Connectors		Crimp/Solder	RG55, RG141, RG142, RG223, RG400	<a href="#">PE44182</a>	\$26.34	\$25.02	\$23.71	\$22.65	92
			RG58	<a href="#">PE44183</a>	\$22.29	\$21.18	\$20.06	\$19.17	93
			RG174, RG316, RG188, PE-B100, PE-C100, .100 inch, LMR-100	<a href="#">PE44184</a>	\$13.23	\$12.70	\$12.30	\$12.04	94
			RG178, RG196	<a href="#">PE44185</a>	\$24.38	\$23.16	\$21.94	\$20.97	95
			RG188-DS, RG316-DS	<a href="#">PE45165</a>	\$21.77	\$20.68	\$19.59	\$18.72	96
<b>Male Right Angle</b>									
Cable Connectors		Crimp/Solder	RG55, RG141, RG142, RG223, RG400	<a href="#">PE44186</a>	\$44.04	\$41.84	\$39.64	\$37.87	97
			RG58	<a href="#">PE44187</a>	\$37.24	\$35.38	\$33.52	\$32.03	98
			RG174, RG316, RG188	<a href="#">PE44188</a>	\$47.13	\$44.77	\$42.42	\$40.53	99
			RG178, RG196	<a href="#">PE44189</a>	\$47.13	\$44.77	\$42.42	\$40.53	1
<b>Female</b>									
Cable Connectors		Crimp/Solder	RG55, RG141, RG142, RG223, RG400	<a href="#">PE44190</a>	\$31.08	\$29.53	\$27.97	\$26.73	2
			RG58	<a href="#">PE44191</a>	\$25.60	\$24.32	\$23.04	\$22.02	3
			RG174, RG316, RG188	<a href="#">PE44192</a>	\$27.70	\$26.32	\$24.93	\$23.82	4
			RG178, RG196	<a href="#">PE44193</a>	\$31.73	\$30.14	\$28.56	\$27.29	5
PCB Mount		Solder	Thru Hole with .200 inch x .067 inch Hole Spacing	<a href="#">PE44198</a>	\$31.08	\$29.53	\$27.97	\$26.73	6
			.062 inch End Launch	<a href="#">PE44201</a>	\$31.08	\$29.53	\$27.97	\$26.73	7
			.062 inch End Launch	<a href="#">PE44202</a>	\$31.08	\$29.53	\$27.97	\$26.73	8
<b>Female, Bulkhead Mount</b>									
Cable Connectors		Crimp/Solder	RG55, RG141, RG142, RG223, RG400 with .235 inch D Hole	<a href="#">PE44194</a>	\$30.17	\$28.66	\$27.15	\$25.95	9
			RG58 with .235 inch D Hole	<a href="#">PE44195</a>	\$27.06	\$25.71	\$24.35	\$23.27	10
			.100 inch, RG316, RG174, RG188, LMR-100, LMR-100A, LMR-100A-FR, PE-C100, PE-B100 with .235 inch D Hole	<a href="#">PE44196</a>	\$25.78	\$24.49	\$23.20	\$22.17	11
			RG178, RG196 with .235 inch D Hole	<a href="#">PE44197</a>	\$31.35	\$29.78	\$28.22	\$26.96	12
<b>Female, 4 Hole Flange Mount</b>									
Terminal		Solder	Solder Cup with .340 inch Hole Spacing	<a href="#">PE44200</a>	\$34.78	\$33.04	\$31.30	\$29.91	13
<b>Female Right Angle</b>									
PCB Mount		Solder	Thru Hole with .200 inch x .067 inch Hole Spacing	<a href="#">PE44199</a>	\$34.78	\$33.04	\$31.30	\$29.91	14

\* Fits MIL-C-17 and equivalent cable versions only

Connectors

See Our Website For Current Pricing & Real-Time Stock Availability!



## SMA, 2.92mm Torque Wrenches



Type	Bit Hex Size (in.)	Preset Torque (in.-lbs.)	Model No	1 Pc. Price	See Web for Volume Pricing			ROW
SMA, 2.92mm	5/16 inch	5 in.-lbs	<a href="#">PE5019-19</a>	Call				
		8 in.-lbs	<a href="#">PE5011-1</a>	\$228.23				

## SMB Connectors





Connection Method	Product Image	Attachment Cable/Contact	Coax Type / Termination Type	Model No.	PRICE				ROW
					1-24	25-49	50-99	100 +	
<b>Plug</b>									
Cable Connectors		Crimp/Solder	RG174, RG316, RG188, LMR-100, PE-B100, PE-C100, .100 inch	<a href="#">PE4046</a>	\$12.57	\$11.94	\$11.31	\$10.81	15
			RG178, RG196	<a href="#">PE4080</a>	\$17.85	\$16.96	\$16.07	\$15.35	16
			RG316-DS, RG188-DS	<a href="#">PE44792</a>	\$14.33	\$13.61	\$12.90	\$12.32	17
			RG58, RG303, RG141, PE-C195, PE-P195, LMR-195, .195 inch	<a href="#">PE4523</a>	\$18.52	\$17.59	\$16.67	\$15.93	18
			RG55, RG142, RG223, RG400	<a href="#">PE4593</a>	\$17.56	\$16.68	\$15.80	\$15.10	19
	Clamp/Solder	RG174, RG316, RG188, .100 inch, PE-B100, PE-C100, LMR-100	<a href="#">PE4200</a>	\$17.23	\$16.37	\$15.51	\$14.82	20	
		RG178, RG196	<a href="#">PE4250</a>	\$21.46	\$20.39	\$19.31	\$18.46	21	
		PE-SR405AL, PE-SR405FL, RG405	<a href="#">PE4356</a>	\$17.05	\$16.37	\$15.86	\$15.52	22	
	Solder/Solder	RG405, PE-SR405FL, PE-SR405FLJ	<a href="#">PE45119</a>	\$8.64	\$8.21	\$7.78	\$7.43	23	
PCB Mount		Solder	Thru Hole with .200 inch x .067 inch Hole Spacing	<a href="#">PE4366</a>	\$24.86	\$23.62	\$22.37	\$21.38	24
<b>Plug, Bulkhead Mount</b>									
Terminal		Solder	Solder Cup with .177 inch D Hole	<a href="#">PE4288</a>	\$34.80	\$33.06	\$31.32	\$29.93	25
<b>Plug Right Angle</b>									
Cable Connectors		Crimp/Solder	RG174, RG316, RG188, LMR-100, PE-B100, PE-C100, .100 inch	<a href="#">PE4052</a>	\$9.69	\$9.21	\$8.72	\$8.33	26
			RG178, RG196	<a href="#">PE4159</a>	\$20.15	\$19.14	\$18.14	\$17.33	27
			RG188-DS, RG316-DS	<a href="#">PE44818</a>	\$15.61	\$14.83	\$14.05	\$13.42	28
			RG58, RG303, RG141, PE-C195, PE-P195, LMR-195, .195 inch	<a href="#">PE4522</a>	\$22.39	\$21.27	\$20.15	\$19.26	29
			RG55, RG142, RG223, RG400	<a href="#">PE4595</a>	\$20.83	\$19.79	\$18.75	\$17.91	30
	Clamp/Solder	RG174, RG316, RG188	<a href="#">PE4260</a>	\$34.03	\$32.33	\$30.63	\$29.27	31	
		RG178, RG196	<a href="#">PE4261</a>	\$39.25	\$37.29	\$35.33	\$33.76	32	
		PE-SR405AL, PE-SR405FL, PE-SR405FLJ, PE-SR405TN, RG405	<a href="#">PE4358</a>	\$18.89	\$17.95	\$17.00	\$16.25	33	
	PCB Mount		Solder	Thru Hole with .200 inch x .067 inch Hole Spacing	<a href="#">PE4245</a>	\$21.89	\$20.80	\$19.70	\$18.83
<b>Jack</b>									
Cable Connectors		Crimp/Solder	RG174, RG316, RG188, LMR-100, PE-B100, PE-C100, .100 inch	<a href="#">PE4096</a>	\$14.83	\$14.09	\$13.35	\$12.75	35
			RG188-DS, RG316-DS	<a href="#">PE45158</a>	\$12.67	\$12.04	\$11.40	\$10.90	36
			RG178, RG196	<a href="#">PE4926</a>	\$26.53	\$25.20	\$23.88	\$22.82	37
			RG174, RG316, RG188, PE-B100, PE-C100, .100 inch, LMR-100	<a href="#">PE4268</a>	\$31.52	\$30.26	\$29.31	\$28.68	38
			RG178, RG196	<a href="#">PE4269</a>	\$26.78	\$25.44	\$24.10	\$23.03	39
	Clamp/Solder	PE-SR405AL, PE-SR405FL, RG405	<a href="#">PE4360</a>	\$17.24	\$16.38	\$15.52	\$14.83	40	
		Thru Hole with .200 inch x .067 inch Hole Spacing	<a href="#">PE4174</a>	\$7.46	\$7.09	\$6.71	\$6.42	41	
		Surface Mount	<a href="#">PE44119</a>	\$10.02	\$9.52	\$9.02	\$8.62	42	
	PCB Mount		Solder	.062 inch End Launch	<a href="#">PE44129</a>	\$22.55	\$21.42	\$20.30	\$19.39
.042 inch End Launch				<a href="#">PE44132</a>	\$10.21	\$9.80	\$9.50	\$9.29	44
.062 inch End Launch				<a href="#">PE44135</a>	\$20.21	\$19.20	\$18.19	\$17.38	45
.042 inch End Launch				<a href="#">PE44137</a>	\$21.08	\$20.03	\$18.97	\$18.13	46

\* Fits MIL-C-17 and equivalent cable versions only

## SMB Connectors

Connection Method	Product Image	Attachment Cable/Contact	Coax Type / Termination Type	Model No.	PRICE				ROW
					1-24	25-49	50-99	100 +	
<b>Jack, Bulkhead Mount</b>									
Cable Connectors		Crimp/Solder	RG174, RG316, RG188, LMR-100, PE-B100, PE-C100, .100 inch	<a href="#">PE4097</a>	\$17.20	\$16.34	\$15.48	\$14.79	47
			RG178, RG196	<a href="#">PE4364</a>	\$16.32	\$15.50	\$14.69	\$14.04	48
			RG55, RG141, RG142, RG223, RG400 with .177 inch D Hole	<a href="#">PE44048</a>	\$34.58	\$32.85	\$31.12	\$29.74	49
			RG58	<a href="#">PE44094</a>	\$27.87	\$26.48	\$25.08	\$23.97	50
			RG188-DS, RG316-DS	<a href="#">PE45159</a>	\$13.98	\$13.28	\$12.58	\$12.02	51
		Clamp/Solder	RG174, RG316, RG188 with .177 inch D Hole	<a href="#">PE4276</a>	\$18.23	\$17.32	\$16.41	\$15.68	52
PE-SR405AL, PE-SR405FL, RG405			<a href="#">PE4362</a>	\$17.94	\$17.04	\$16.15	\$15.43	53	
Terminal		Solder	Solder Cup with .177 inch D Hole	<a href="#">PE4167</a>	\$7.81	\$7.42	\$7.03	\$6.72	54
PCB Mount			Solder Cup with .177 inch D Hole	<a href="#">PE4170</a>	\$15.30	\$14.54	\$13.77	\$13.16	55
			Thru Hole with .177 inch D Hole	<a href="#">PE44123</a>	\$21.10	\$20.26	\$19.62	\$19.20	56
<b>Jack, 2 Hole Flange Mount</b>									
Terminal		Solder	Solder Cup with .328 inch Hole Spacing	<a href="#">PE44139</a>	\$31.52	\$29.94	\$28.37	\$27.11	57
<b>Jack, 4 Hole Flange Mount</b>									
Terminal		Solder	Solder Cup with .232 inch Hole Spacing	<a href="#">PE44142</a>	\$27.37	\$26.00	\$24.63	\$23.54	58
<b>Jack Right Angle</b>									
PCB Mount		Solder	Thru Hole with .200 inch x .067 inch Hole Spacing	<a href="#">PE4177</a>	\$12.46	\$11.84	\$11.21	\$10.72	59
			Surface Mount	<a href="#">PE44121</a>	\$23.79	\$22.60	\$21.41	\$20.46	60
<b>Jack Right Angle, Bulkhead Mount</b>									
Terminal		Solder	Solder Cup with .177 inch D Hole	<a href="#">PE4284</a>	\$29.13	\$27.67	\$26.22	\$25.05	61
PCB Mount			Thru Hole with .177 inch D Hole	<a href="#">PE44875</a>	\$21.10	\$20.05	\$18.99	\$18.15	62

## SMC Connectors













Connection Method	Product Image	Attachment Cable/Contact	Coax Type / Termination Type	Model No.	PRICE				ROW
					1-24	25-49	50-99	100 +	
<b>Plug</b>									
Cable Connectors		Crimp/Solder	RG174, RG316, RG188, LMR-100, PE-B100, PE-C100, .100 inch	<a href="#">PE4045</a>	\$12.92	\$12.27	\$11.63	\$11.11	63
			RG178, RG196	<a href="#">PE4074</a>	\$18.63	\$17.70	\$16.77	\$16.02	64
			RG188-DS, RG316-DS	<a href="#">PE45155</a>	\$12.41	\$11.79	\$11.17	\$10.67	65
			RG55, RG142, RG223, RG400	<a href="#">PE45396</a>	\$22.05	\$20.95	\$19.85	\$18.96	66
			PE-P195, PE-C195, RG58, RG141, RG303, .195 inch, LMR-195	<a href="#">PE4558</a>	\$21.66	\$20.58	\$19.49	\$18.63	67
		Clamp/Solder	RG174, RG316, RG188, LMR-100, PE-B100, PE-C100, .100 inch	<a href="#">PE4201</a>	\$14.30	\$13.59	\$12.87	\$12.30	68
RG178, RG196			<a href="#">PE4202</a>	\$18.28	\$17.37	\$16.45	\$15.72	69	
		Solder/Solder	PE-SR405AL, PE-SR405FL, PE-SR405FLJ, PE-SR405TN, RG405	<a href="#">PE44977</a>	\$26.52	\$25.19	\$23.87	\$22.81	70
PCB Mount		Solder	Thru Hole with .200 inch x .067 inch Hole Spacing	<a href="#">PE4367</a>	\$15.53	\$14.75	\$13.98	\$13.36	71

\* Fits MIL-C-17 and equivalent cable versions only

Connectors

See Our Website For Current Pricing & Real-Time Stock Availability!

# SMC Connectors

Connection Method	Product Image	Attachment Cable/Contact	Coax Type / Termination Type	Model No.	PRICE				ROW	
					1-24	25-49	50-99	100 +		
<b>Plug Right Angle</b>										
Cable Connectors		Crimp/Solder	RG174, RG316, RG188, LMR-100, PE-B100, PE-C100, .100 inch	<a href="#">PE4051</a>	\$16.93	\$16.08	\$15.24	\$14.56	72	
			RG178, RG196	<a href="#">PE4160</a>	\$17.62	\$16.74	\$15.86	\$15.15	73	
			RG316-DS, RG188-DS	<a href="#">PE44876</a>	\$15.77	\$14.98	\$14.19	\$13.56	74	
			RG58, LMR-195	<a href="#">PE45193</a>	\$19.88	\$18.89	\$17.89	\$17.10	75	
	RG55, RG142, RG223, RG400	<a href="#">PE4596</a>	\$20.83	\$19.79	\$18.75	\$17.91	76			
		Clamp/Solder	RG174, RG316, RG188, LMR-100, PE-B100, PE-C100, .100 inch	<a href="#">PE4262</a>	\$17.22	\$16.36	\$15.50	\$14.81	77	
RG178, RG196			<a href="#">PE4263</a>	\$15.06	\$14.31	\$13.55	\$12.95	78		
PE-SR405AL, PE-SR405FL, RG405			<a href="#">PE4359</a>	\$42.40	\$40.28	\$38.16	\$36.46	79		
PCB Mount		Solder	Thru Hole with .200 inch x .067 inch Hole Spacing	<a href="#">PE4246</a>	\$47.47	\$45.57	\$44.15	\$43.20	80	
<b>Jack</b>										
Cable Connectors		Crimp/Solder	RG174, RG316, RG188, LMR-100, PE-B100, PE-C100, .100 inch	<a href="#">PE4094</a>	\$18.23	\$17.32	\$16.41	\$15.68	81	
			RG188-DS, RG316-DS	<a href="#">PE45156</a>	\$16.30	\$15.49	\$14.67	\$14.02	82	
			RG178, RG196	<a href="#">PE4927</a>	\$35.31	\$33.54	\$31.78	\$30.37	83	
PCB Mount		Solder	Thru Hole with .200 inch x .067 inch Hole Spacing	<a href="#">PE4175</a>	\$9.89	\$9.40	\$8.90	\$8.51	85	
			Surface Mount	<a href="#">PE44120</a>	\$18.20	\$17.29	\$16.38	\$15.65	86	
			.062 inch End Launch	<a href="#">PE44130</a>	\$50.82	\$48.28	\$45.74	\$43.71	87	
			.042 inch End Launch	<a href="#">PE44133</a>	\$24.17	\$22.96	\$21.75	\$20.79	88	
			.062 inch End Launch	<a href="#">PE44136</a>	\$26.52	\$25.19	\$23.87	\$22.81	89	
			.042 inch End Launch	<a href="#">PE44138</a>	\$16.66	\$15.99	\$15.49	\$15.16	90	
<b>Jack, Bulkhead Mount</b>										
Cable Connectors		Crimp/Solder	RG174, RG316, RG188, LMR-100, PE-B100, PE-C100, .100 inch with .177 inch D Hole	<a href="#">PE4095</a>	\$17.20	\$16.34	\$15.48	\$14.79	91	
			RG178, RG196	<a href="#">PE4365</a>	\$32.20	\$30.59	\$28.98	\$27.69	92	
			RG55, RG141, RG142, RG223, RG400	<a href="#">PE44047</a>	\$25.74	\$24.45	\$23.17	\$22.14	93	
			RG58	<a href="#">PE44095</a>	\$25.74	\$24.45	\$23.17	\$22.14	94	
			RG188-DS, RG316-DS with .177 inch D Hole	<a href="#">PE45157</a>	\$15.38	\$14.61	\$13.84	\$13.23	95	
	RG174, RG316, RG188 with .177 inch D Hole	<a href="#">PE4278</a>	\$31.35	\$29.78	\$28.22	\$26.96	96			
Terminal		Clamp/Solder	RG178, RG196 with .177 inch D Hole	<a href="#">PE4279</a>	\$31.35	\$29.78	\$28.22	\$26.96	97	
			Solder/Solder	RG405, PE-SR405FL, PE-SR405AL with .177 inch D Hole	<a href="#">PE45210</a>	\$38.49	\$36.95	\$35.80	\$35.03	98
				Solder	Solder Cup with .177 inch D Hole	<a href="#">PE4107</a>	\$14.56	\$13.83	\$13.10	\$12.52
PCB Mount		Solder	Solder Cup with .177 inch D Hole		<a href="#">PE4171</a>	\$13.82	\$13.13	\$12.44	\$11.89	1
			Thru Hole with .177 inch D Hole	<a href="#">PE44124</a>	\$32.47	\$30.85	\$29.22	\$27.92	2	
			Thru Hole	<a href="#">PE45147</a>	\$23.70	\$22.52	\$21.33	\$20.38	3	
Terminal		Solder	.062 inch End Launch	<a href="#">PE44848</a>	\$30.28	\$28.77	\$27.25	\$26.04	4	
			<b>Jack, 4 Hole Flange Mount</b>							
Terminal		Solder	Solder Cup with .232 inch Hole Spacing	<a href="#">PE44143</a>	\$22.30	\$21.19	\$20.07	\$19.18	5	
<b>Jack Right Angle</b>										
PCB Mount		Solder	Thru Hole with .200 inch x .067 inch Hole Spacing	<a href="#">PE4178</a>	\$16.06	\$15.26	\$14.45	\$13.81	6	
			Surface Mount	<a href="#">PE44122</a>	\$7.91	\$7.51	\$7.12	\$6.80	7	
<b>Jack Right Angle, Bulkhead Mount</b>										
Terminal		Solder	Solder Cup with .177 inch D Hole	<a href="#">PE4285</a>	\$31.36	\$29.79	\$28.22	\$26.97	8	

Connectors





See Our Website For Current Pricing & Real-Time Stock Availability!

\* Fits MIL-C-17 and equivalent cable versions only

## SMC Connectors











Connection Method	Product Image	Attachment Cable/Contact	Coax Type / Termination Type	Model No.	PRICE				ROW
					1-24	25-49	50-99	100 +	
<b>Jack Right Angle, Bulkhead Mount</b>									
PCB Mount		Solder	Thru Hole with .177 inch D Hole	<a href="#">PE44127</a>	\$25.19	\$23.93	\$22.67	\$21.66	9

## SMP Connectors

Connection Method	Product Image	Attachment Cable/Contact	Coax Type / Termination Type	Model No.	PRICE			ROW
					1 Pc.	See Web for Volume Pricing		
<b>Male</b>								
PCB Mount		Solder	.062 inch End Launch	<a href="#">PE44943</a>	\$34.93	See Web for Volume Pricing		10
			.092 inch End Launch	<a href="#">PE44942</a>	\$42.61			11
			Edge Launch	<a href="#">PE44955</a>	\$32.29			12
			End Launch	<a href="#">PE44482</a>	\$27.32			13
			End Launch	<a href="#">PE44777</a>	\$13.50			14
			End Launch	<a href="#">PE44879</a>	\$13.08			15
			End Launch	<a href="#">PE44880</a>	\$13.08			16
			Surface Mount	<a href="#">PE44481</a>	\$36.68			17
			Surface Mount	<a href="#">PE44944</a>	\$53.32			18
			Surface Mount	<a href="#">PE44946</a>	\$29.57			19
			Surface Mount	<a href="#">PE44947</a>	\$82.53			20
			Surface Mount	<a href="#">PE44952</a>	\$45.18			21
			Surface Mount	<a href="#">PE45278TR1</a>	\$36.02			22
			Surface Mount	<a href="#">PE45278TR1500</a>	\$28,600.56			23
			Thru Hole	<a href="#">PE44480</a>	\$35.27			24
			Thru Hole	<a href="#">PE44775</a>	\$15.30			25
			Thru Hole	<a href="#">PE44776</a>	\$10.19			26
			Thru Hole	<a href="#">PE44840</a>	\$10.19			27
			Thru Hole	<a href="#">PE44849</a>	\$13.50			28
			Thru Hole	<a href="#">PE44910</a>	\$33.72			29
			Thru Hole	<a href="#">PE44936</a>	\$38.14			30
			Thru Hole	<a href="#">PE44937</a>	\$40.07			31
			Thru Hole	<a href="#">PE44940</a>	\$66.80			32
Thru Hole	<a href="#">PE44941</a>	\$34.72	33					
Thru Hole	<a href="#">PE44957</a>	\$43.59	34					
Thru Hole	<a href="#">PE44958</a>	\$49.54	35					
Thru Hole	<a href="#">PE44959</a>	\$52.65	36					
Thru Hole	<a href="#">PE44960</a>	\$29.68	37					
Thru Hole	<a href="#">PE44965</a>	\$30.86	38					
Thru Hole	<a href="#">PE44966</a>	\$40.19	39					
Thru Hole	<a href="#">PE44967</a>	\$32.14	40					
Thru Hole with .100 inch x .031 inch Hole Spacing	<a href="#">PE44348</a>	\$33.62	41					
Terminal		Pin	<a href="#">PE44779</a>	\$20.51			42	
		Pin	<a href="#">PE44780</a>	\$20.89			43	
<b>Male, Bulkhead Mount</b>								
Cable Connectors		Solder/Solder	RG405, RG405 Tinned, PE-SR405FL, PE-SR405AL, PE-SR405FLJ, PE-SR405TN with 4.83 mm Diameter	<a href="#">PE44483</a>	\$43.94	See Web for Volume Pricing		44
			PE-SR405AL, PE-SR405FL, PE-SR405FLJ, PE-SR405TN, RG405	<a href="#">PE44961</a>	\$36.78			45
			RG405, PE-SR405FL, PE-SR405FLJ	<a href="#">PE45126</a>	\$33.07			46
<b>Male, 2 Hole Flange Mount</b>								
Shroud		None	None	<a href="#">PE44935</a>	\$17.79			47
			None	<a href="#">PE44907</a>	\$17.61			48
			None	<a href="#">PE44916</a>	\$18.48			49
			None	<a href="#">PE44948</a>	\$19.01			50
			None	<a href="#">PE44949</a>	\$18.85			51
			None	<a href="#">PE44950</a>	\$19.20			52
Cable Connectors		Solder/Solder	RG405, PE-SR405FL, PE-SR405FLJ	<a href="#">PE45127</a>	\$35.14			54

\* Fits MIL-C-17 and equivalent cable versions only

# SMP Connectors

Connection Method	Product Image	Attachment Cable/Contact	Coax Type / Termination Type	Model No.	PRICE				ROW
					1-24	25-49	50-99	100 +	
<b>Male, 2 Hole Flange Mount</b>									
Terminal		Solder	Pin	<a href="#">PE44938</a>	\$44.94	\$42.69	\$40.45	\$38.65	55
<b>Male, Press-In</b>									
Shroud		None	None	<a href="#">PE44954</a>	\$18.30	\$17.39	\$16.47	\$15.74	56
<b>Male, Thread-In</b>									
Shroud		None	None	<a href="#">PE44906</a>	\$23.79	\$22.60	\$21.41	\$20.46	57
			None	<a href="#">PE44953</a>	\$24.96	\$23.71	\$22.46	\$21.47	58
Terminal		Solder	Pin	<a href="#">PE44909</a>	\$41.44	\$39.37	\$37.30	\$35.64	59
			Pin	<a href="#">PE44912</a>	\$31.75	\$30.16	\$28.58	\$27.31	60
			Pin	<a href="#">PE44931</a>	\$51.69	\$49.11	\$46.52	\$44.45	61
			Pin	<a href="#">PE44956</a>	\$72.12	\$68.51	\$64.91	\$62.02	62
			Pin	<a href="#">PE44963</a>	\$39.71	\$37.72	\$35.74	\$34.15	63
			Pin	<a href="#">PE44964</a>	\$64.50	\$61.28	\$58.05	\$55.47	64
<b>Male, Solder</b>									
Shroud		None	None	<a href="#">PE44932</a>	\$19.20	\$18.24	\$17.28	\$16.51	65
Terminal		Solder	Pin	<a href="#">PE44918</a>	\$33.85	\$32.16	\$30.47	\$29.11	66
			Pin	<a href="#">PE44919</a>	\$34.79	\$33.05	\$31.31	\$29.92	67
			Pin	<a href="#">PE44920</a>	\$26.20	\$24.89	\$23.58	\$22.53	68
			Pin	<a href="#">PE44921</a>	\$29.98	\$28.48	\$26.98	\$25.78	69
			Pin	<a href="#">PE44922</a>	\$34.79	\$33.05	\$31.31	\$29.92	70
			Pin	<a href="#">PE44923</a>	\$31.43	\$29.86	\$28.29	\$27.03	71
			Pin	<a href="#">PE44924</a>	\$33.20	\$31.54	\$29.88	\$28.55	72
			Pin	<a href="#">PE44925</a>	\$28.88	\$27.44	\$25.99	\$24.84	73
			Pin	<a href="#">PE44926</a>	\$32.12	\$30.51	\$28.91	\$27.62	74
			Pin	<a href="#">PE44927</a>	\$28.31	\$26.89	\$25.48	\$24.35	75
			Pin	<a href="#">PE44928</a>	\$34.46	\$32.74	\$31.01	\$29.64	76
			Pin	<a href="#">PE44930</a>	\$27.78	\$26.39	\$25.00	\$23.89	77
Pin	<a href="#">PE44933</a>	\$40.86	\$38.82	\$36.77	\$35.14	78			
Pin	<a href="#">PE44945</a>	\$48.57	\$46.14	\$43.71	\$41.77	79			
<b>Male Right Angle</b>									
PCB Mount		Solder	Thru Hole	<a href="#">PE44934</a>	\$58.69	\$55.76	\$52.82	\$50.47	80
<b>Female</b>									
Cable Connectors		Solder/Solder	RG178, RG196	<a href="#">PE44655</a>	\$51.08	\$48.53	\$45.97	\$43.93	81
			PE-047SR, PE-SR047AL, PE-SR047FL	<a href="#">PE44785</a>	\$23.83	\$22.64	\$21.45	\$20.49	82
			PE-SR405AL, PE-SR405FL, PE-SR405FLJ, PE-SR405TN, RG405	<a href="#">PE44786</a>	\$21.80	\$20.71	\$19.62	\$18.75	83
			.086 Microporous	<a href="#">PE44917</a>	\$28.74	\$27.30	\$25.87	\$24.72	84
			RG405, PE-SR405AL, PE-SR405FL, PE-SR405FLJ	<a href="#">PE45285</a>	\$9.63	\$9.15	\$8.67	\$8.28	85
			RG178, RG196	<a href="#">PE45287</a>	\$9.85	\$9.36	\$8.87	\$8.47	86
PCB Mount		Solder	Thru Hole	<a href="#">PE44939</a>	\$69.47	\$66.00	\$62.52	\$59.74	87
Cable Connectors			PE-047SR, PE-SR047AL, PE-SR047FL	<a href="#">PE45277</a>	\$4.43	\$4.25	\$4.12	\$4.03	88
<b>Female Right Angle</b>									
Cable Connectors		Crimp/Crimp	RG178, RG196	<a href="#">PE45290</a>	\$9.58	\$9.10	\$8.62	\$8.24	89

Connectors

See Our Website For Current Pricing & Real-Time Stock Availability!

\* Fits MIL-C-17 and equivalent cable versions only

 Technical Support  
+1 (949) 261-1920

 Same-Day Shipping,  
Even Custom Cable Assemblies

## SMP Connectors

Connection Method	Product Image	Attachment Cable/Contact	Coax Type / Termination Type	Model No.	PRICE				ROW	
					1-24	25-49	50-99	100 +		
<b>Female Right Angle</b>										
Cable Connectors		Crimp/Solder	RG316, RG174, LMR-100	<a href="#">PE45128</a>	\$14.23	\$13.52	\$12.81	\$12.24	90	
			Solder/Solder	PE-047SR, PE-SR047AL, PE-SR047FL	<a href="#">PE44274</a>	\$52.94	\$50.29	\$47.65	\$45.53	91
				PE-SR405AL, PE-SR405FL, PE-SR405FLJ, PE-SR405TN, RG405	<a href="#">PE44275</a>	\$33.74	\$32.05	\$30.37	\$29.02	92
	PE-SR405AL, PE-SR405FL, PE-SR405FLJ, PE-SR405TN, RG405	<a href="#">PE44908</a>		\$33.71	\$32.02	\$30.34	\$28.99	93		
	PE-047SR, PE-SR047FL, PE-SR047AL	<a href="#">PE44911</a>		\$32.40	\$30.78	\$29.16	\$27.86	94		
	RG405, PE-SR405FL, PE-SR405FLJ	<a href="#">PE44913</a>		\$57.19	\$54.33	\$51.47	\$49.18	95		
	RG178, RG196	<a href="#">PE44914</a>		\$38.87	\$36.93	\$34.98	\$33.43	96		
	Solder	RG405, PE-SR405FL, PE-SR405FLJ	<a href="#">PE44915</a>	\$28.26	\$26.85	\$25.43	\$24.30	97		
		RG405, PE-SR405AL, PE-SR405FL, PE-SR405FLJ	<a href="#">PE45248</a>	\$10.32	\$9.80	\$9.29	\$8.88	98		
PE-047SR, PE-SR047AL, PE-SR047FL	<a href="#">PE45249</a>	\$12.52	\$11.89	\$11.27	\$10.77	99				

## SSMA Connectors











Connection Method	Product Image	Attachment Cable/Contact	Coax Type / Termination Type	Model No.	PRICE				ROW
					1-24	25-49	50-99	100 +	
<b>Male</b>									
Cable Connectors		Crimp/Solder	RG174, RG316, RG188, LMR-100, PE-B100, PE-C100, .100 inch	<a href="#">PE44379</a>	\$24.83	\$23.59	\$22.35	\$21.35	1
			RG178, RG196	<a href="#">PE44381</a>	\$28.55	\$27.12	\$25.70	\$24.55	2
			RG188-DS, RG316-DS	<a href="#">PE44416</a>	\$23.52	\$22.34	\$21.17	\$20.23	3
	Solder/Solder	RG174, RG316, RG188	<a href="#">PE4184</a>	\$25.29	\$24.03	\$22.76	\$21.75	4	
		RG178, RG196	<a href="#">PE4199</a>	\$27.06	\$25.71	\$24.35	\$23.27	5	
		PE-SR405AL, PE-SR405FL, PE-SR405FLJ, RG405	<a href="#">PE44383</a>	\$35.22	\$33.46	\$31.70	\$30.29	6	
		PE-034SR	<a href="#">PE44440</a>	\$29.28	\$27.82	\$26.35	\$25.18	7	
		PE-047SR, PE-SR047AL, PE-SR047FL	<a href="#">PE44441</a>	\$34.83	\$33.09	\$31.35	\$29.95	8	
	Solder (Without Contact)	PE-SR405AL, PE-SR405FL, PE-SR405FLJ, RG405	<a href="#">PE44382</a>	\$25.74	\$24.45	\$23.17	\$22.14	9	
PCB Mount	Solder	Thru Hole with .200 inch x .067 inch Hole Spacing	<a href="#">PE44430</a>	\$26.42	\$25.10	\$23.78	\$22.72	10	
<b>Male, 2 Hole Flange Mount</b>									
Terminal		Solder	Solder Cup with .328 inch Hole Spacing	<a href="#">PE44431</a>	\$30.17	\$28.66	\$27.15	\$25.95	11
<b>Male, 4 Hole Flange Mount</b>									
Terminal		Solder	Solder Cup with .232 inch Hole Spacing	<a href="#">PE44432</a>	\$26.90	\$25.56	\$24.21	\$23.13	12
<b>Male Right Angle</b>									
Cable Connectors		Crimp/Solder	RG174, RG316, RG188, PE-B100, PE-C100, .100 inch, LMR-100	<a href="#">PE44378</a>	\$27.62	\$26.24	\$24.86	\$23.75	13
			RG178, RG196	<a href="#">PE44380</a>	\$56.81	\$53.97	\$51.13	\$48.86	14
			RG188-DS, RG316-DS	<a href="#">PE44418</a>	\$34.47	\$32.75	\$31.02	\$29.64	15
	Solder/Solder	PE-SR405AL, PE-SR405FL, PE-SR405FLJ, RG405	<a href="#">PE44384</a>	\$41.02	\$38.97	\$36.92	\$35.28	16	
		RG174, RG316, RG188	<a href="#">PE44401</a>	\$35.04	\$33.29	\$31.54	\$30.13	17	
		RG178, RG196	<a href="#">PE44402</a>	\$33.75	\$32.40	\$31.39	\$30.71	18	
		RG188-DS, RG316-DS	<a href="#">PE44419</a>	\$29.96	\$28.46	\$26.96	\$25.77	19	
		PE-034SR	<a href="#">PE44420</a>	\$56.52	\$53.69	\$50.87	\$48.61	20	
		PE-047SR, PE-SR047AL, PE-SR047FL	<a href="#">PE44421</a>	\$46.99	\$44.64	\$42.29	\$40.41	21	
<b>Female</b>									
Cable Connectors		Crimp/Solder	RG174, RG316, RG188, PE-B100, PE-C100, .100 inch, LMR-100	<a href="#">PE44385</a>	\$29.52	\$28.04	\$26.57	\$25.39	22
			RG178, RG196	<a href="#">PE44386</a>	\$46.86	\$44.52	\$42.17	\$40.30	23
			RG188-DS, RG316-DS	<a href="#">PE44422</a>	\$27.77	\$26.38	\$24.99	\$23.88	24

\* Fits MIL-C-17 and equivalent cable versions only

Connectors

See Our Website For Current Pricing & Real-Time Stock Availability!

## SSMA Connectors

Connection Method	Product Image	Attachment Cable/Contact	Coax Type / Termination Type	Model No.	PRICE				ROW
					1-24	25-49	50-99	100 +	
<b>Female</b>									
Cable Connectors		Solder/Solder	PE-SR405AL, PE-SR405FL, PE-SR405FLJ, RG405	<a href="#">PE44387</a>	\$29.39	\$27.92	\$26.45	\$25.28	25
			RG174, RG316, RG188	<a href="#">PE44403</a>	\$26.26	\$24.95	\$23.63	\$22.58	26
			RG178, RG196	<a href="#">PE44404</a>	\$29.18	\$27.72	\$26.26	\$25.09	27
			PE-034SR	<a href="#">PE44424</a>	\$34.41	\$32.69	\$30.97	\$29.59	28
			PE-047SR, PE-SR047AL, PE-SR047FL	<a href="#">PE44425</a>	\$32.81	\$31.17	\$29.53	\$28.22	29
PCB Mount		Solder	Thru Hole with .200 inch x .067 inch Hole Spacing	<a href="#">PE44391</a>	\$34.64	\$32.91	\$31.18	\$29.79	30
<b>Female, Bulkhead Mount</b>									
Cable Connectors		Crimp/Solder	.100 inch, RG316, RG174, RG188, LMR-100, LMR-100A, LMR-100A-FR, PE-C100, PE-B100 with .177 inch D Hole	<a href="#">PE44388</a>	\$43.71	\$41.52	\$39.34	\$37.59	31
			RG178, RG196 with .177 inch D Hole	<a href="#">PE44389</a>	\$36.60	\$34.77	\$32.94	\$31.48	32
			RG188-DS, RG316-DS with .177 inch D Hole	<a href="#">PE44426</a>	\$30.37	\$28.85	\$27.33	\$26.12	33
		Solder/Solder	PE-SR405AL, PE-SR405FL, RG405 with .177 inch D Hole	<a href="#">PE44390</a>	\$34.78	\$33.04	\$31.30	\$29.91	34
			RG174, RG316, RG188 with .177 inch D Hole	<a href="#">PE44405</a>	\$25.71	\$24.42	\$23.14	\$22.11	35
			RG178, RG196 with .177 inch D Hole	<a href="#">PE44406</a>	\$27.77	\$26.38	\$24.99	\$23.88	36
			RG188-DS, RG316-DS with .177 inch D Hole	<a href="#">PE44427</a>	\$24.52	\$23.29	\$22.07	\$21.09	37
			PE-034SR with .177 inch D Hole	<a href="#">PE44428</a>	\$45.56	\$43.28	\$41.00	\$39.18	38
		PE-047SR, PE-SR047AL, PE-SR047FL with .177 inch D Hole	<a href="#">PE44429</a>	\$48.30	\$45.89	\$43.47	\$41.54	39	
Terminal		Solder	Turret with .177 inch D Hole	<a href="#">PE44392</a>	\$37.50	\$35.63	\$33.75	\$32.25	40
			Solder Cup with .177 inch D Hole	<a href="#">PE44393</a>	\$31.49	\$29.92	\$28.34	\$27.08	41
PCB Mount		Solder	.042 inch End Launch	<a href="#">PE45405</a>	\$27.23	\$25.87	\$24.51	\$23.42	42
			.062 inch End Launch	<a href="#">PE45406</a>	\$27.23	\$25.87	\$24.51	\$23.42	43
<b>Female, 2 Hole Flange Mount</b>									
Cable Connectors		Solder/Solder	PE-047SR, PE-SR047AL, PE-SR047FL with .328 inch Hole Spacing	<a href="#">PE44436</a>	\$44.20	\$41.99	\$39.78	\$38.01	44
			PE-SR405AL, PE-SR405FL, PE-SR405FLJ, RG405 with .328 inch Hole Spacing	<a href="#">PE44437</a>	\$23.31	\$22.14	\$20.98	\$20.05	45
Terminal		Solder	Solder Cup with .328 inch Hole Spacing	<a href="#">PE44395</a>	\$48.29	\$45.88	\$43.46	\$41.53	46
			Pin with .328 inch Hole Spacing	<a href="#">PE44433</a>	\$48.26	\$45.85	\$43.43	\$41.50	47
<b>Female, 4 Hole Flange Mount</b>									
Cable Connectors		Solder/Solder	PE-047SR, PE-SR047AL, PE-SR047FL with .232 inch Hole Spacing	<a href="#">PE44438</a>	\$45.07	\$42.82	\$40.56	\$38.76	48
			PE-SR405AL, PE-SR405FL, RG405 with .232 inch Hole Spacing	<a href="#">PE44439</a>	\$37.73	\$35.84	\$33.96	\$32.45	49
Terminal		Solder	Solder Cup with .232 inch Hole Spacing	<a href="#">PE44394</a>	\$37.25	\$35.39	\$33.53	\$32.04	50
			Pin with .232 inch Hole Spacing	<a href="#">PE44434</a>	\$43.86	\$41.67	\$39.47	\$37.72	51
<b>Female Right Angle</b>									
PCB Mount		Solder	Thru Hole with .200 inch x .067 inch Hole Spacing	<a href="#">PE44435</a>	\$49.05	\$46.60	\$44.15	\$42.18	52







## SSMB Connectors

Connection Method	Product Image	Attachment Cable/Contact	Coax Type / Termination Type	Model No.	PRICE				ROW
					1-24	25-49	50-99	100 +	
<b>Plug</b>									
Cable Connectors		Crimp/Solder	RG174, RG316, RG188, LMR-100, PE-B100, PE-C100, .100 inch	<a href="#">PE4017</a>	\$30.99	\$29.44	\$27.89	\$26.65	53
			RG178, RG196	<a href="#">PE4019</a>	\$28.70	\$27.27	\$25.83	\$24.68	54
			RG188-DS, RG316-DS	<a href="#">PE45153</a>	\$28.21	\$26.80	\$25.39	\$24.26	55





\* Fits MIL-C-17 and equivalent cable versions only



## SSMB Connectors

Connection Method	Product Image	Attachment Cable/Contact	Coax Type / Termination Type	Model No.	PRICE				ROW
					1-24	25-49	50-99	100 +	
<b>Plug Right Angle</b>									
Cable Connectors		Crimp/Solder	RG174, RG179, RG316, RG188, PE-B100, PE-C100, .100 inch, LMR-100	<a href="#">PE4334</a>	\$53.86	\$51.17	\$48.47	\$46.32	56
			RG188-DS, RG316-DS	<a href="#">PE45162</a>	\$27.77	\$26.66	\$25.83	\$25.27	57
			RG178, RG196	<a href="#">PE45195</a>	\$19.23	\$18.27	\$17.31	\$16.54	58
<b>Jack</b>									
PCB Mount		Solder	Thru Hole with .100 inch x .031 inch Hole Spacing	<a href="#">PE4340</a>	\$14.38	\$13.66	\$12.94	\$12.37	59
<b>Jack, Bulkhead Mount</b>									
Cable Connectors		Crimp/Solder	.100 inch, RG316, RG174, RG188, LMR-100, LMR-100A, LMR-100A-FR, PE-C100, PE-B100 with .126 inch D Hole	<a href="#">PE4336</a>	\$39.34	\$37.37	\$35.41	\$33.83	60
			RG178, RG196 with .126 inch D Hole	<a href="#">PE4337</a>	\$33.86	\$32.17	\$30.47	\$29.12	61
			RG316-DS, RG188-DS with .126 inch D Hole	<a href="#">PE44842</a>	\$29.88	\$28.39	\$26.89	\$25.70	62
Terminal		Solder	Turret with .126 inch D Hole	<a href="#">PE4338</a>	\$25.32	\$24.05	\$22.79	\$21.78	63
			Turret with .126 inch D Hole	<a href="#">PE4339</a>	\$26.27	\$24.96	\$23.64	\$22.59	64
<b>Jack, 4 Hole Flange Mount</b>									
Terminal		Solder	Tab with .164 inch x .067 inch Hole Spacing	<a href="#">PE44455</a>	\$25.52	\$24.24	\$22.97	\$21.95	65
<b>Jack Right Angle</b>									
PCB Mount		Solder	Thru Hole with .100 inch x .031 inch Hole Spacing	<a href="#">PE4341</a>	\$25.92	\$24.62	\$23.33	\$22.29	66

## SSMC Connectors

Connection Method	Product Image	Attachment Cable/Contact	Coax Type / Termination Type	Model No.	PRICE				ROW
					1-24	25-49	50-99	100 +	
<b>Plug</b>									
Cable Connectors		Crimp/Solder	RG316, RG174, RG188	<a href="#">PE45209</a>	\$14.69	\$13.96	\$13.22	\$12.63	67
			RG178, RG196	<a href="#">PE45490</a>	\$26.37	\$25.05	\$23.73	\$22.68	68
			LMR-100A, RG188, RG174, PE-C100-LSZH, PE-B100, LMR-100A-FR, RG316	<a href="#">PE45491</a>	\$24.15	\$22.94	\$21.74	\$20.77	69
		RG188-DS, RG316-DS	<a href="#">PE45492</a>	\$25.77	\$23.97	\$22.16	\$20.62	70	
		Clamp/Solder	PE-SR405AL, PE-SR405FL, PE-SR405FLJ, PE-SR405TN, RG405	<a href="#">PE45365</a>	\$23.48	\$22.31	\$21.13	\$20.19	71
			PE-047SR, PE-SR047AL, PE-SR047FL	<a href="#">PE45366</a>	\$23.73	\$22.54	\$21.36	\$20.41	72
<b>Plug Right Angle</b>									
Cable Connectors		Crimp/Solder	RG178, RG196	<a href="#">PE45496</a>	\$18.27	\$17.36	\$16.44	\$15.71	73
			RG316, RG188, RG174, PE-C100-LSZH, PE-B100, LMR-100A-FR, LMR-100A	<a href="#">PE45497</a>	\$20.84	\$19.80	\$18.76	\$17.92	74
			RG316-DS, RG188-DS	<a href="#">PE45498</a>	\$20.53	\$19.09	\$17.66	\$16.42	75
		Solder/Solder	PE-SR405AL, PE-SR405FL, PE-SR405FLJ, PE-SR405TN, RG405	<a href="#">PE45384</a>	\$20.50	\$19.48	\$18.45	\$17.63	76
			PE-047SR, PE-SR047AL, PE-SR047FL	<a href="#">PE45385</a>	\$23.59	\$22.41	\$21.23	\$20.29	77
PCB Mount		Solder	Thru Hole	<a href="#">PE45379</a>	\$29.31	\$27.84	\$26.38	\$25.21	78
<b>Jack</b>									
PCB Mount		Solder	Surface Mount	<a href="#">PE45376</a>	\$17.00	\$16.15	\$15.30	\$14.62	79
<b>Jack, Bulkhead Mount</b>									
Cable Connectors		Crimp/Solder	RG-178, RG-196	<a href="#">PE45493</a>	\$22.54	\$21.41	\$20.29	\$19.38	80
			RG316, RG188	<a href="#">PE45494</a>	\$22.27	\$21.16	\$20.04	\$19.15	81









\* Fits MIL-C-17 and equivalent cable versions only

Connectors

See Our Website For Current Pricing & Real-Time Stock Availability!



## SSMC Connectors

Connection Method	Product Image	Attachment Cable/Contact	Coax Type / Termination Type	Model No.	PRICE				ROW
					1 Pc.	See Web for Volume Pricing			
<b>Jack, Bulkhead Mount</b>									
Cable Connectors		Clamp/Solder	PE-SR405AL, PE-SR405FL, PE-SR405FLJ, PE-SR405TN, RG405	<a href="#">PE45370</a>	\$16.92				82
			PE-047SR, PE-SR047AL, PE-SR047FL	<a href="#">PE45371</a>	\$23.45				83
Terminal		Solder	Turret	<a href="#">PE45375</a>	\$18.41				84
			Turret	<a href="#">PE45390</a>	\$17.00				85
<b>Jack, 2 Hole Flange Mount</b>									
Terminal		Solder	Solder Cup	<a href="#">PE45380</a>	\$109.65			See Web for Volume Pricing	86
<b>Jack, 4 Hole Flange Mount</b>									
Terminal		Solder	Solder Cup	<a href="#">PE45391</a>	\$62.83				87
<b>Jack Right Angle</b>									
PCB Mount		Solder	Surface Mount	<a href="#">PE45377</a>	\$27.69				88
<b>Jack Right Angle, Bulkhead Mount</b>									
Cable Connectors		Crimp/Solder	PE-SR405AL, PE-SR405FL, PE-SR405FLJ, PE-SR405TN, RG405	<a href="#">PE45387</a>	\$32.86			See Web for Volume Pricing	89
			RG178, RG196	<a href="#">PE45499</a>	\$20.19				90
		Solder/Solder	PE-047SR, PE-SR047AL, PE-SR047FL	<a href="#">PE45388</a>	\$36.55				91
Terminal			Solder	Turret	<a href="#">PE45378</a>	\$38.80			
PCB Mount		Turret		<a href="#">PE45389</a>	\$34.30				93

## TNC Connectors

Connection Method	Product Image	Attachment Cable/Contact	Coax Type / Termination Type	Model No.	PRICE				ROW
					1-24	25-49	50-99	100 +	
<b>Male</b>									
Cable Connectors		Crimp/Crimp	RG55, RG142, RG223, RG400, RG141	<a href="#">PE4047</a>	\$12.75	\$12.11	\$11.48	\$10.97	94
			RG174, RG316, RG188, LMR-100, PE-B100, PE-C100, .100 inch	<a href="#">PE4302</a>	\$19.74	\$18.75	\$17.77	\$16.98	95
			PE-C200, LMR-200	<a href="#">PE44804</a>	\$9.82	\$9.33	\$8.84	\$8.45	96
			RG188-DS, RG316-DS	<a href="#">PE45161</a>	\$19.97	\$18.97	\$17.97	\$17.17	97
		Crimp/Solder	RG59*, RG62*, RG71	<a href="#">PE4071</a>	\$12.62	\$11.99	\$11.36	\$10.85	98
			RG58, RG303, RG141, PE-C195, PE-P195, LMR-195, .195 inch	<a href="#">PE4156</a>	\$7.56	\$7.18	\$6.80	\$6.50	99
			PE-C200	<a href="#">PE44062</a>	\$17.56	\$16.68	\$15.80	\$15.10	1
			PE-C400, PE-B400, PE-B405, LMR-400, LMR-400-DB, LMR-400-UF, .400 inch	<a href="#">PE44293</a>	\$33.74	\$32.05	\$30.37	\$29.02	2
	RG213, RG8		<a href="#">PE4446</a>	\$18.82	\$17.88	\$16.94	\$16.19	3	
	RG214, RG9, RG225, RG393		<a href="#">PE4447</a>	\$28.36	\$26.94	\$25.52	\$24.39	4	
	PE-C240, RG8X, .240 inch, LMR-240, LMR-240-DB, LMR-240-UF, B7808A		<a href="#">PE44634</a>	\$13.32	\$12.65	\$11.99	\$11.46	5	
	RG122, RG58 Plenum, RG58-P		<a href="#">PE45065</a>	\$6.22	\$5.91	\$5.60	\$5.35	6	
	LMR-100, PE-C100, RG174, RG188, RG316	<a href="#">TC-100-TM</a>	\$18.50	\$18.50	\$18.50	\$18.50	7		
	LMR-195, PE-C195	<a href="#">TC-195-TM-X</a>	\$15.25	\$15.25	\$15.25	\$15.25	8		
	LMR-240, PE-C240	<a href="#">TC-240-TM-X</a>	\$9.25	\$9.25	\$9.25	\$9.25	9		
	LMR-400, PE-C400	<a href="#">TC-400-TM-X</a>	\$11.25	\$11.25	\$11.25	\$11.25	10		

\* Fits MIL-C-17 and equivalent cable versions only



# TNC Connectors











Connection Method	Product Image	Attachment Cable/Contact	Coax Type / Termination Type	Model No.	PRICE			ROW
					1 Pc.	See Web for Volume Pricing		
<b>Male</b>								
Cable Connectors		Clamp/Solder	RG58, RG55, RG141, RG142, RG223, RG400, RG303, PE-C195, PE-P195, LMR-195	<a href="#">PE4067</a>	\$25.40	See Web for Volume Pricing		11
			RG213, RG214, RG8, RG9, RG11*, RG225, RG393, RG144*, RG215, RG216*	<a href="#">PE4088</a>	\$19.46			12
			PE-SR405AL, PE-SR405FL, RG405	<a href="#">PE4142</a>	\$19.96			13
			PE-SR402AL, PE-SR402FL, RG402	<a href="#">PE4143</a>	\$21.96			14
			RG59*, RG62*, RG71	<a href="#">PE4154</a>	\$16.02			15
			RG174, RG316, RG188	<a href="#">PE4303</a>	\$15.21			16
			PE-C200	<a href="#">PE44061</a>	\$15.96			17
			RG178, RG196	<a href="#">PE4448</a>	\$19.17			18
			PE-C400, PE-B400, PE-B405, LMR-400, LMR-400-DB, LMR-400-UF, .400 inch	<a href="#">PE4449</a>	\$19.64			19
			PE-P300LL	<a href="#">PE44810</a>	\$100.73			20
			PE-P142LL	<a href="#">PE44815</a>	\$60.95			21
			RG8X, PE-C240, .240 inch, B7808A, LMR-240	<a href="#">PE45437</a>	\$16.30			22
			PE-P160LL	<a href="#">PE45443</a>	\$80.44			23
		Solder/Solder	PE-SR405AL, PE-SR405FL, PE-SR405FLJ, PE-SR405TN, RG405	<a href="#">PE44708</a>	\$14.69			24
			PE-SR402AL, PE-SR402FL, PE-SR402FLJ, PE-SR402TN, RG402	<a href="#">PE44709</a>	\$14.69			25
			PE-SR402AL, PE-SR402FL, PE-SR402FLJ, PE-SR402TN, RG402 with .480 inch D Hole	<a href="#">PE4648</a>	\$31.48			26
			PE-SR405AL, PE-SR405FL, RG405	<a href="#">PE4649</a>	\$29.00			27
			PE-SR401AL, PE-SR401FL, RG401	<a href="#">PE4909</a>	\$66.44			28
			PE-047SR, PE-SR047AL, PE-SR047FL	<a href="#">PE4975</a>	\$28.27			29
		Crimp/Non-Solder Contact	LMR-200, PE-C200	<a href="#">EZ-200-TM-X</a>	\$20.75			30
			LMR-240, PE-C240	<a href="#">EZ-240-TM-X</a>	\$13.50			31
			LMR-400, PE-C400, PE-B400, PE-B405	<a href="#">EZ-400-TM-X</a>	\$12.75			32
			LMR-600, PE-C600	<a href="#">EZ-600-TM-X</a>	\$19.00			33
<b>Male, 4 Hole Flange Mount</b>								
Terminal		Solder	Pin with .531 inch Hole Spacing	<a href="#">PE44654</a>	\$74.06			34
			Solder Cup with .531 inch Hole Spacing	<a href="#">PE4470</a>	\$22.42			35
<b>Male Right Angle</b>								
Cable Connectors		Crimp/Crimp	RG58, RG303, RG141, PE-C195, PE-P195, LMR-195, .195 inch	<a href="#">PE4451</a>	\$25.28	See Web for Volume Pricing		36
				Crimp/Solder	RG55, RG141, RG142, RG223, RG400			<a href="#">PE4450</a>
	RG174, RG316, RG188, .100 inch, PE-B100, PE-C100, LMR-100	<a href="#">PE4455</a>			\$26.47			38
	PE-C240, RG8X, .240 inch, LMR-240, LMR-240-DB, LMR-240-UF, B7808A	<a href="#">PE44635</a>			\$24.99			39
	PE-C200, LMR-200	<a href="#">PE44846</a>			\$19.14			40
	RG188-DS, RG316-DS	<a href="#">PE45174</a>			\$22.72			41
	LMR-400, PE-C400	<a href="#">TC-400-TM-RA-D</a>			\$24.25			42
		Clamp/Solder	RG58, RG55, RG141, RG142, RG223, RG400, RG303, PE-C195, PE-P195, LMR-195	<a href="#">PE4054</a>	\$26.81			43
			RG213, RG214, RG8, RG9, RG11*, RG225, RG393, RG144*, RG216*, RG215	<a href="#">PE4146</a>	\$35.95			44
			RG59*, RG62*	<a href="#">PE4452</a>	\$46.62			45
			RG174, RG316, RG188	<a href="#">PE4454</a>	\$20.32			46
			PE-P142LL	<a href="#">PE44812</a>	\$146.16			47
		Solder/Solder	PE-SR405AL, PE-SR405FL, PE-SR405FLJ, PE-SR405TN, RG405	<a href="#">PE44710</a>	\$16.03			49
PE-SR402AL, PE-SR402FL, PE-SR402FLJ, PE-SR402TN, RG402			<a href="#">PE44711</a>	\$15.74	50			
<b>Female</b>								
Cable Connectors		Crimp/Solder	RG55, RG142, RG223, RG400	<a href="#">PE4457</a>	\$14.75			51
			RG58, RG303, RG141, PE-C195, PE-P195, LMR-195, .195 inch	<a href="#">PE4458</a>	\$15.84			52
			RG59*, RG62*, RG71	<a href="#">PE4459</a>	\$17.05			53
			RG174, RG316, RG188, PE-B100, PE-C100, .100 inch, LMR-100	<a href="#">PE4462</a>	\$20.30			54
			PE-C240, RG8X, .240 inch, LMR-240, LMR-240-DB, LMR-240-UF, B7808A	<a href="#">PE44636</a>	\$18.66			55
			RG316, RG174, LMR-100	<a href="#">PE45143</a>	\$9.92			56

\* Fits MIL-C-17 and equivalent cable versions only

Connectors

See Our Website For Current Pricing & Real-Time Stock Availability!

# TNC Connectors

Connection Method	Product Image	Attachment Cable/Contact	Coax Type / Termination Type	Model No.	PRICE			ROW	
					1 Pc.	See Web for Volume Pricing			
<b>Female</b>									
Cable Connectors		Clamp/Solder	RG58, RG55, RG141, RG142, RG223, RG400, RG303, PE-C195, PE-P195, LMR-195	<a href="#">PE4068</a>	\$13.83			57	
			PE-SR405AL, PE-SR405FL, RG405	<a href="#">PE4144</a>	\$21.95			58	
			PE-SR402AL, PE-SR402FL, RG402	<a href="#">PE4145</a>	\$21.95			59	
			RG213, RG214, RG8, RG9, RG11*, RG225, RG393, RG144*, RG216*, RG215	<a href="#">PE4155</a>	\$37.98			60	
			RG59*, RG62*, RG71	<a href="#">PE4460</a>	\$15.49			61	
			RG174, RG316, RG188	<a href="#">PE4461</a>	\$15.64			62	
			RG178, RG196	<a href="#">PE4463</a>	\$17.56			63	
		Solder/Solder	PE-SR405AL, PE-SR405FL, PE-SR405FLJ, PE-SR405TN, RG405	<a href="#">PE44712</a>	\$12.60			64	
			PE-SR402AL, PE-SR402FL, PE-SR402FLJ, PE-SR402TN, RG402	<a href="#">PE44713</a>	\$14.69			65	
<b>Female, Bulkhead Mount</b>									
Cable Connectors		Crimp/Solder	RG58, RG303, RG141, PE-C195, PE-P195, LMR-195, .195 inch with .480 inch D Hole	<a href="#">PE4151</a>	\$20.77	See Web for Volume Pricing		66	
			RG55, RG142, RG223, RG400 with .480 inch D Hole	<a href="#">PE4153</a>	\$19.16		67		
			RG59*, RG62* with .480 inch D Hole	<a href="#">PE4465</a>	\$23.90		68		
			RG174, RG316, RG188, LMR-100, PE-B100, PE-C100, .100 inch with .480 inch D Hole	<a href="#">PE4466</a>	\$25.22		69		
			RG174, RG316, RG188, .100 inch, PE-B100, PE-C100, LMR-100	<a href="#">PE44899</a>	\$60.76		70		
			RG174, RG316, RG188, .100 inch, PE-B100, PE-C100, LMR-100	<a href="#">PE44900</a>	\$60.76		71		
			RG188-DS, RG316-DS with .480 inch D Hole	<a href="#">PE45177</a>	\$22.28		72		
			PE-SR405AL, PE-SR405FL, RG405 with .480 inch D Hole	<a href="#">PE4149</a>	\$26.26		73		
			PE-SR402AL, PE-SR402FL, RG402 with .480 inch D Hole	<a href="#">PE4150</a>	\$26.26		74		
			RG58, RG142, RG223, RG400, RG141, RG303, RG55, PE-C195, PE-P195 with .480 inch D Hole	<a href="#">PE4152</a>	\$20.79		75		
		Clamp/Solder	RG174, RG316, RG188 with .480 inch D Hole	<a href="#">PE4304</a>	\$21.56	76			
			RG59*, RG62*, RG71 with .480 inch D Hole	<a href="#">PE4464</a>	\$31.64	77			
			RG178, RG196 with .480 inch D Hole	<a href="#">PE4467</a>	\$20.32	78			
			PE-P142LL	<a href="#">PE44811</a>	\$98.29	79			
			PE-047SR, PE-SR047AL, PE-SR047FL	<a href="#">PE44897</a>	\$33.02	80			
			PE-P160LL	<a href="#">PE45444</a>	\$102.71	81			
				Solder/Solder	PE-SR405AL, PE-SR405FL, PE-SR405FLJ, RG405 with .480 inch D Hole	<a href="#">PE4147</a>	\$76.60	82	
					PE-SR402AL, PE-SR402FL, RG402 with .480 inch D Hole	<a href="#">PE4148</a>	\$70.81	83	
					PE-SR405AL, PE-SR405FL, PE-SR405FLJ, PE-SR405TN, RG405	<a href="#">PE44714</a>	\$17.64	84	
					PE-SR402AL, PE-SR402FL, PE-SR402FLJ, PE-SR402TN, RG402	<a href="#">PE44715</a>	\$17.64	85	
PE-SR405AL, PE-SR405FL, PE-SR405FLJ, PE-SR405TN, RG405	<a href="#">PE44898</a>	\$50.00			86				
Terminal		Solder Cup with .410 inch D Hole			<a href="#">PE4063</a>	\$24.61	See Web for Volume Pricing	87	
		Solder Cup with .350 inch D Hole			<a href="#">PE4065</a>	\$14.86		88	
		Eyelet with .350 inch D Hole			<a href="#">PE4305</a>	\$33.44		89	
		Solder Cup with .350 inch D Hole			<a href="#">PE4306</a>	\$13.35		90	
		Solder Cup with .480 inch D Hole		<a href="#">PE4468</a>	\$18.65	91			
		Eyelet with .480 inch D Hole		<a href="#">PE4469</a>	\$43.85	92			
PCB Mount		Solder	Edge Mount	<a href="#">PE44894</a>	\$67.67		93		
Terminal			None	<a href="#">PE45130</a>	\$12.67		94		
Cable Connectors			RG178, RG196	<a href="#">PE45132</a>	\$22.25		95		
<b>Female, 4 Hole Flange Mount</b>									
Cable Connectors		Clamp/Solder	RG316-DS, RG188-DS	<a href="#">PE44901</a>	\$35.66			96	

Connectors

See Our Website For Current Pricing & Real-Time Stock Availability!

\* Fits MIL-C-17 and equivalent cable versions only







Technical Support  
+1 (949) 261-1920



Same-Day Shipping,  
Even Custom  
Cable Assemblies

## TNC Connectors



Connection Method	Product Image	Attachment Cable/Contact	Coax Type / Termination Type	Model No.	PRICE				ROW
					1-24	25-49	50-99	100 +	
<b>Female, 4 Hole Flange Mount</b>									
Terminal		Solder	Solder Cup with .500 inch Threaded Hole Spacing	<a href="#">PE4064</a>	\$14.63	\$13.90	\$13.17	\$12.58	97
			Solder Cup with .500 inch Hole Spacing	<a href="#">PE4064SP</a>	\$21.79	\$20.70	\$19.61	\$18.74	98
<b>Female Right Angle</b>									
PCB Mount		Solder/Solder	Thru Hole with .380 inch x .083 inch Hole Spacing	<a href="#">PE44659</a>	\$16.03	\$15.23	\$14.43	\$13.79	99
<b>Female Right Angle, Bulkhead Mount</b>									
Cable Connectors		Crimp/Solder	PE-C200, LMR-200 with .480 inch D Hole	<a href="#">PE44847</a>	\$22.89	\$21.75	\$20.60	\$19.69	1
Terminal		Solder	Solder Cup with .361 inch D Hole	<a href="#">PE4471</a>	\$32.20	\$30.59	\$28.98	\$27.69	2
PCB Mount			Surface Mount	<a href="#">PE44892</a>	\$70.57	\$67.04	\$63.51	\$60.69	3

## TNC Torque Wrenches



Type	Bit Hex Size (in.)	Preset Torque (in.-lbs.)	Model No	1-9	10-24	25-49	50+	ROW
TNC	5/8 inch	14 in-lbs	<a href="#">PE5011-4</a>	\$333.13	\$316.47	\$299.82	\$286.49	
	9/16 inch	13 in-lbs	<a href="#">PE5011-8</a>	\$314.28	\$298.57	\$282.85	\$270.28	
	5/8 inch	12 in-lbs	<a href="#">PE5019-10</a>	\$222.15	\$211.04	\$199.94	\$191.05	

## Reverse Polarity TNC Connectors











Connection Method	Product Image	Attachment Cable/Contact	Coax Type / Termination Type	Model No.	PRICE				ROW
					1-24	25-49	50-99	100 +	
<b>Male</b>									
Cable Connectors		Crimp/Crimp	LMR-200, PE-C200	<a href="#">PE45283</a>	\$19.33	\$18.36	\$17.40	\$16.62	4
				Crimp/Solder	PE-C240, RG8X, .240 inch, LMR-240, LMR-240-DB, LMR-240-UF, B7808A	<a href="#">PE44670</a>	\$11.97	\$11.37	\$10.77
	PE-C400, PE-B400, PE-B405, LMR-400, LMR-400-DB, LMR-400-UF, .400 inch	<a href="#">PE44672</a>			\$22.37	\$21.25	\$20.13	\$19.24	6
	RG188-DS, RG316-DS	<a href="#">PE45180</a>			\$22.17	\$21.28	\$20.62	\$20.17	7
	RG213, RG8	<a href="#">PE4660</a>			\$21.77	\$20.68	\$19.59	\$18.72	8
	RG214, RG9, RG225, RG393	<a href="#">PE4661</a>			\$25.43	\$24.16	\$22.89	\$21.87	9
	RG55, RG141, RG142, RG223, RG400	<a href="#">PE4663</a>			\$15.11	\$14.35	\$13.60	\$12.99	10
	RG58	<a href="#">PE4664</a>			\$12.82	\$12.18	\$11.54	\$11.03	11
	RG59*, RG62*, RG71	<a href="#">PE4666</a>			\$15.20	\$14.44	\$13.68	\$13.07	12
	RG174, RG316, RG188, LMR-100, PE-B100, PE-C100, .100 inch	<a href="#">PE4668</a>			\$24.11	\$23.15	\$22.42	\$21.94	13
	RG213, RG55, RG141, RG142, RG223, RG400, RG303, PE-C195, PE-P195, LMR-195	<a href="#">PE4659</a>			\$23.91	\$22.71	\$21.52	\$20.56	14
	RG58, RG55, RG141, RG142, RG223, RG400, RG303, PE-C195, PE-P195, LMR-195	<a href="#">PE4662</a>	\$13.41	\$12.74	\$12.07	\$11.53	15		
		Clamp/Solder	RG59*, RG62*, RG71	<a href="#">PE4665</a>	\$14.70	\$13.97	\$13.23	\$12.64	16
			RG174, RG316, RG188	<a href="#">PE4667</a>	\$21.66	\$20.58	\$19.49	\$18.63	17
			RG178, RG196	<a href="#">PE4669</a>	\$19.37	\$18.40	\$17.43	\$16.66	18
PE-SR402AL, PE-SR402FL, RG402			<a href="#">PE4670</a>	\$22.81	\$21.67	\$20.53	\$19.62	19	
PE-SR405AL, PE-SR405FL, RG405			<a href="#">PE4672</a>	\$23.48	\$22.31	\$21.13	\$20.19	20	
PE-B400, PE-B405			<a href="#">PE4674</a>	\$22.31	\$21.19	\$20.08	\$19.19	21	

\* Fits MIL-C-17 and equivalent cable versions only

Connectors

See Our Website For Current Pricing & Real-Time Stock Availability!

# Reverse Polarity TNC Connectors



Connection Method	Product Image	Attachment Cable/Contact	Coax Type / Termination Type	Model No.	PRICE				ROW
					1-24	25-49	50-99	100 +	
<b>Male</b>									
Cable Connectors		Solder/Solder	PE-SR402AL, PE-SR402FL, RG402	<a href="#">PE4671</a>	\$32.39	\$30.77	\$29.15	\$27.86	22
			PE-SR405AL, PE-SR405FL, RG405	<a href="#">PE4673</a>	\$48.03	\$45.63	\$43.23	\$41.31	23
<b>Male, 4 Hole Flange Mount</b>									
Terminal		Solder	Solder Cup with .531 inch Hole Spacing	<a href="#">PE4708</a>	\$25.05	\$23.80	\$22.55	\$21.54	24
<b>Male Right Angle</b>									
Cable Connectors		Crimp/Solder	RG55, RG141, RG142, RG223, RG400	<a href="#">PE4677</a>	\$24.57	\$23.34	\$22.11	\$21.13	25
			RG58, RG303, RG141, PE-C195, PE-P195, LMR-195, .195 inch	<a href="#">PE4678</a>	\$26.81	\$25.47	\$24.13	\$23.06	26
			RG316, RG174, RG188, LMR-100, PE-B100, PE-C100, .100 inch	<a href="#">PE4681</a>	\$28.96	\$27.51	\$26.06	\$24.91	27
		Clamp/Solder	RG58, RG55, RG141, RG142, RG223, RG400	<a href="#">PE4676</a>	\$34.41	\$32.69	\$30.97	\$29.59	28
			RG59*, RG62*	<a href="#">PE4679</a>	\$29.69	\$28.21	\$26.72	\$25.53	29
			RG316, RG174, RG188	<a href="#">PE4680</a>	\$24.64	\$23.41	\$22.18	\$21.19	30
			RG178, RG196	<a href="#">PE4682</a>	\$27.06	\$25.71	\$24.35	\$23.27	31
<b>Female</b>									
Cable Connectors		Crimp/Solder	PE-C240, RG8X, .240 inch, LMR-240, LMR-240-DB, LMR-240-UF, B7808A	<a href="#">PE44671</a>	\$21.71	\$20.62	\$19.54	\$18.67	32
			PE-C400, PE-B400, PE-B405, LMR-400, LMR-400-DB, LMR-400-UF, .400 inch	<a href="#">PE44673</a>	\$16.93	\$16.08	\$15.24	\$14.56	33
			RG55, RG142, RG223, RG400	<a href="#">PE4685</a>	\$15.91	\$15.11	\$14.32	\$13.68	34
			RG58, RG303, RG141, PE-C195, PE-P195, LMR-195, .195 inch	<a href="#">PE4686</a>	\$17.62	\$16.74	\$15.86	\$15.15	35
			RG59*, RG62*	<a href="#">PE4687</a>	\$19.01	\$18.06	\$17.11	\$16.35	36
			RG316, RG174, RG188, LMR-100, PE-B100, PE-C100, .100 inch	<a href="#">PE4690</a>	\$22.50	\$21.38	\$20.25	\$19.35	37
		Clamp/Solder	RG213, RG8, RG215, RG225, RG214, RG393	<a href="#">PE4683</a>	\$44.00	\$41.80	\$39.60	\$37.84	38
			RG58, RG55, RG141, RG142, RG223, RG400	<a href="#">PE4684</a>	\$19.05	\$18.10	\$17.15	\$16.38	39
			RG59*, RG62*	<a href="#">PE4688</a>	\$22.62	\$21.49	\$20.36	\$19.45	40
			RG316, RG174, RG188	<a href="#">PE4689</a>	\$17.10	\$16.25	\$15.39	\$14.71	41
			RG178, RG196	<a href="#">PE4691</a>	\$17.75	\$16.86	\$15.98	\$15.27	42
			PE-SR402AL, PE-SR402FL, RG402	<a href="#">PE4692</a>	\$22.08	\$20.98	\$19.87	\$18.99	43
				PE-SR405AL, PE-SR405FL, RG405	<a href="#">PE4693</a>	\$22.81	\$21.67	\$20.53	\$19.62
		Crimp/Non-Solder Contact	LMR-200, PE-C200	<a href="#">EZ-200-TFRP</a>	\$17.86	\$17.86	\$17.86	\$17.86	45
<b>Female, Bulkhead Mount</b>									
Cable Connectors		Crimp/Solder	RG174, RG316, RG188, .100 inch, PE-B100, PE-C100, LMR-100	<a href="#">PE44902</a>	\$50.63	\$48.10	\$45.57	\$43.54	46
			RG174, RG316, RG188, .100 inch, PE-B100, PE-C100, LMR-100	<a href="#">PE44903</a>	\$57.87	\$54.98	\$52.08	\$49.77	47
			RG188-DS, RG316-DS with .480 inch D Hole	<a href="#">PE45181</a>	\$23.46	\$22.29	\$21.11	\$20.18	48
			RG55, RG141, RG142, RG223, RG400 with .480 inch D Hole	<a href="#">PE4695</a>	\$20.45	\$19.43	\$18.41	\$17.59	49
			.195 inch, RG58, RG141, RG303, LMR-195, LMR-195-FR, PE-C195, PE-P195 with .480 inch D Hole	<a href="#">PE4696</a>	\$27.51	\$26.13	\$24.76	\$23.66	50
			RG59*, RG62* with .480 inch D Hole	<a href="#">PE4698</a>	\$25.19	\$23.93	\$22.67	\$21.66	51
		Clamp/Solder	.100 inch, RG316, RG174, RG188, LMR-100, LMR-100A, LMR-100A-FR, PE-C100, PE-B100 with .480 inch D Hole	<a href="#">PE4700</a>	\$27.58	\$26.20	\$24.82	\$23.72	52
			RG58, RG142, RG223, RG400, RG141, RG303, RG55, PE-C195, PE-P195 with .480 inch D Hole	<a href="#">PE4694</a>	\$22.76	\$21.62	\$20.48	\$19.57	53
			RG316, RG174, RG188 with .480 inch D Hole	<a href="#">PE4699</a>	\$24.64	\$23.41	\$22.18	\$21.19	54
			RG178, RG196 with .480 inch D Hole	<a href="#">PE4701</a>	\$23.17	\$22.01	\$20.85	\$19.93	55
			PE-SR402AL, PE-SR402FL, RG402 with .480 inch D Hole	<a href="#">PE4702</a>	\$26.79	\$25.45	\$24.11	\$23.04	56
			PE-SR405AL, PE-SR405FL, RG405 with .480 inch D Hole	<a href="#">PE4703</a>	\$27.06	\$25.71	\$24.35	\$23.27	57
Terminal		Solder	Solder Cup with .410 inch D Hole	<a href="#">PE4704</a>	\$19.79	\$18.80	\$17.81	\$17.02	58
			Solder Cup with .350 inch D Hole	<a href="#">PE4706</a>	\$19.79	\$18.80	\$17.81	\$17.02	59
			Solder Cup with .480 inch D Hole	<a href="#">PE4707</a>	\$23.80	\$22.61	\$21.42	\$20.47	60

Connectors









See Our Website For Current Pricing & Real-Time Stock Availability!

\* Fits MIL-C-17 and equivalent cable versions only

## Reverse Polarity TNC Connectors

Connection Method	Product Image	Attachment Cable/Contact	Coax Type / Termination Type	Model No.	PRICE				ROW
					1-24	25-49	50-99	100 +	
<b>Female, 4 Hole Flange Mount</b>									
Terminal		Solder	Solder Cup with .500 inch Threaded Hole Spacing	<a href="#">PE4705</a>	\$25.72	\$24.43	\$23.15	\$22.12	61
<b>Female Right Angle, Bulkhead Mount</b>									
PCB Mount		Solder	Surface Mount	<a href="#">PE44893</a>	\$70.57	\$67.04	\$63.51	\$60.69	62

## UHF Connectors

Connection Method	Product Image	Attachment Cable/Contact	Coax Type / Termination Type	Model No.	PRICE				ROW
					1-24	25-49	50-99	100 +	
<b>Male</b>									
Cable Connectors		Crimp/Solder	RG58, RG303, RG141, PE-C195, PE-P195, LMR-195, .195 inch	<a href="#">PE4069</a>	\$10.65	\$10.12	\$9.59	\$9.16	63
			RG59*, RG62*, RG71	<a href="#">PE4073</a>	\$8.55	\$8.12	\$7.70	\$7.35	64
			RG213, RG215, RG8	<a href="#">PE4295</a>	\$16.49	\$15.67	\$14.84	\$14.18	65
			RG214, RG9, RG225, RG393	<a href="#">PE44051</a>	\$14.42	\$13.70	\$12.98	\$12.40	66
			RG55, RG141, RG142, RG223, RG400	<a href="#">PE44053</a>	\$9.60	\$9.12	\$8.64	\$8.26	67
			PE-B400, PE-B405, PE-C400, LMR-400, .400 inch	<a href="#">PE44054</a>	\$13.34	\$12.67	\$12.01	\$11.47	68
		Clamp/Solder	RG213, RG214, RG8, RG9, RG11*, RG225, RG393, RG144*, RG215, RG216*	<a href="#">PE44050</a>	\$12.80	\$12.16	\$11.52	\$11.01	69
			RG58, RG55, RG141, RG142, RG223, RG400, RG303, PE-C195, PE-P195, LMR-195	<a href="#">PE44052</a>	\$12.37	\$11.75	\$11.13	\$10.64	70
	Solder	RG213, RG55, RG141, RG142, RG223, RG400, RG303, PE-C195, PE-P195, LMR-195	<a href="#">PE4020</a>	\$15.51	\$14.73	\$13.96	\$13.34	71	
		RG59*, RG62*, RG71	<a href="#">PE44828</a>	\$13.91	\$13.21	\$12.52	\$11.96	72	
<b>Female</b>									
Cable Connectors		Crimp/Solder	RG55, RG141, RG142, RG223, RG400	<a href="#">PE44057</a>	\$13.11	\$12.45	\$11.80	\$11.27	73
			RG58, RG303, RG141, PE-C195, PE-P195, LMR-195, .195 inch	<a href="#">PE44058</a>	\$17.05	\$16.20	\$15.35	\$14.66	74
		Clamp/Solder	RG213, RG214, RG8, RG9, RG11*, RG225, RG393, RG144*, RG216*, RG215	<a href="#">PE44055</a>	\$16.17	\$15.36	\$14.55	\$13.91	75
			RG58, RG55, RG141, RG142, RG223, RG400, RG303, PE-C195, PE-P195, LMR-195	<a href="#">PE44056</a>	\$17.05	\$16.20	\$15.35	\$14.66	76
<b>Female, Bulkhead Mount</b>									
Terminal		Solder	Solder Cup with .575 inch D Hole	<a href="#">PE44059</a>	\$12.74	\$12.10	\$11.47	\$10.96	77
			Solder Cup with .575 inch D Hole	<a href="#">PE44060</a>	\$10.96	\$10.41	\$9.86	\$9.43	78
<b>Female, 4 Hole Flange Mount</b>									
Terminal		Solder	Solder Cup with .718 inch Hole Spacing	<a href="#">PE45478</a>	\$9.10	\$8.46	\$7.83	\$7.28	79
		Field Replaceable	Slotted Contact	<a href="#">PE44719</a>	\$55.14	\$52.38	\$49.63	\$47.42	80
<b>Sexless</b>									
Cable Connectors		Accessories	RG59*, RG62*, RG71	<a href="#">PE4021</a>	\$1.87	\$1.78	\$1.68	\$1.61	81
			RG58, RG303, RG141, PE-C195, PE-P195, LMR-195, .195 inch	<a href="#">PE4022</a>	\$2.08	\$1.98	\$1.87	\$1.79	82

## UMCX Connectors



Connection Method	Product Image	Attachment Cable/Contact	Coax Type / Termination Type	Model No.	PRICE				ROW
					1-24	25-49	50-99	100 +	
<b>Jack</b>									
PCB Mount		Solder	Surface Mount	<a href="#">PE44594</a>	\$1.80	\$1.71	\$1.62	\$1.55	83

\* Fits MIL-C-17 and equivalent cable versions only



Connectors

See Our Website For Current Pricing & Real-Time Stock Availability!







## D-Subminiature Connectors

Connection Method	Product Image	Attachment Cable/Contact	Coax Type / Termination Type	Model No.	PRICE				ROW
					1-24	25-49	50-99	100 +	
<b>Plug Right Angle</b>									
Cable Connectors		Solder/Solder	RG55, RG142, RG223, RG400	<a href="#">PE44036</a>	\$13.53	\$12.85	\$12.18	\$11.64	84
<b>Receptacle Right Angle</b>									
Cable Connectors		Solder/Solder	PE-SR405AL, PE-SR405FL, RG405	<a href="#">PE44033</a>	\$14.60	\$14.02	\$13.58	\$13.29	85

## 75 Ohm 1.0/2.3 Connectors











Connection Method	Product Image	Attachment Cable/Contact	Coax Type / Termination Type	Model No.	PRICE				ROW
					1-24	25-49	50-99	100 +	
<b>Plug</b>									
Cable Connectors		Crimp/Crimp	BELDEN 735A1	<a href="#">PE45227</a>	\$11.15	\$10.59	\$10.04	\$9.59	86
			BELDEN 1855A	<a href="#">PE45228</a>	\$11.15	\$10.59	\$10.04	\$9.59	87
			RG179-DS	<a href="#">PE45233</a>	\$11.15	\$10.59	\$10.04	\$9.59	88
			RG59*	<a href="#">PE45234</a>	\$11.15	\$10.59	\$10.04	\$9.59	89
			RG6-CATV	<a href="#">PE45235</a>	\$16.74	\$15.90	\$15.07	\$14.40	90
<b>Jack, Bulkhead Mount</b>									
PCB Mount		Solder	Thru Hole	<a href="#">PE45229</a>	\$15.23	\$14.47	\$13.71	\$13.10	91
			Thru Hole	<a href="#">PE45231</a>	\$17.02	\$16.17	\$15.32	\$14.64	92
			End Launch	<a href="#">PE45232</a>	\$18.97	\$18.02	\$17.07	\$16.31	93
<b>Jack Right Angle, Bulkhead Mount</b>									
PCB Mount		Solder	Thru Hole	<a href="#">PE45230</a>	\$14.66	\$13.93	\$13.19	\$12.61	94
			Thru Hole	<a href="#">PE45237</a>	\$17.33	\$16.46	\$15.60	\$14.90	95

## 75 Ohm 1.6/5.6 Connectors

Connection Method	Product Image	Attachment Cable/Contact	Coax Type / Termination Type	Model No.	PRICE				ROW
					1-24	25-49	50-99	100 +	
<b>Plug</b>									
Cable Connectors		Crimp/Solder	RG179, RG187	<a href="#">PE44262</a>	\$17.05	\$16.20	\$15.35	\$14.66	96
			RG59*, RG62*, RG71	<a href="#">PE44263</a>	\$16.17	\$15.36	\$14.55	\$13.91	97
<b>Plug Right Angle</b>									
Cable Connectors		Clamp/Solder	RG179, RG187	<a href="#">PE44264</a>	\$17.28	\$16.42	\$15.55	\$14.86	98
			RG59*	<a href="#">PE44265</a>	\$17.28	\$16.42	\$15.55	\$14.86	99
<b>Jack, Bulkhead Mount</b>									
Cable Connectors		Crimp/Solder	RG179, RG187 with .362 inch DD Hole	<a href="#">PE44266</a>	\$14.82	\$14.08	\$13.34	\$12.75	1
			RG59* with .362 inch DD Hole	<a href="#">PE44267</a>	\$15.74	\$14.95	\$14.17	\$13.54	2
PCB Mount		Solder	Thru Hole with .362 inch Diameter	<a href="#">PE44270</a>	\$15.01	\$14.26	\$13.51	\$12.91	3
<b>Jack Right Angle</b>									
PCB Mount		Solder	Thru Hole with .200 inch x .052 inch Hole Spacing	<a href="#">PE44271</a>	\$17.28	\$16.42	\$15.55	\$14.86	4
<b>Jack Right Angle, Bulkhead Mount</b>									
Cable Connectors		Crimp/Solder	RG179, RG187 with .362 inch DD Hole	<a href="#">PE44268</a>	\$17.28	\$16.42	\$15.55	\$14.86	5

\* Fits MIL-C-17 and equivalent cable versions only

# 75 Ohm BNC Connectors

Connection Method	Product Image	Attachment Cable/Contact	Coax Type / Termination Type	Model No.	PRICE				ROW	
					1-24	25-49	50-99	100 +		
<b>Male</b>										
Cable Connectors		Crimp/Crimp	RG59*, RG62*, RG71	<a href="#">PE4602</a>	\$10.83	\$10.29	\$9.75	\$9.31	6	
		Crimp/Solder	PE-B159, 1855A, Mini 59	<a href="#">PE44584</a>	\$15.11	\$14.35	\$13.60	\$12.99	7	
			PE-B159, 1855A, Mini 59	<a href="#">PE44625</a>	\$11.76	\$11.17	\$10.58	\$10.11	8	
			1505A	<a href="#">PE44626</a>	\$11.24	\$10.68	\$10.12	\$9.67	9	
			1694A	<a href="#">PE44627</a>	\$5.31	\$5.04	\$4.78	\$4.57	10	
			7731A	<a href="#">PE44628</a>	\$9.73	\$9.24	\$8.76	\$8.37	11	
			1505A	<a href="#">PE44631</a>	\$5.63	\$5.35	\$5.07	\$4.84	12	
			1694A	<a href="#">PE44632</a>	\$15.11	\$14.35	\$13.60	\$12.99	13	
			735A	<a href="#">PE44686</a>	\$27.47	\$26.10	\$24.72	\$23.62	14	
			Belden 1694A	<a href="#">PE45116</a>	\$11.83	\$11.24	\$10.65	\$10.17	15	
			Belden 150A	<a href="#">PE45117</a>	\$8.94	\$8.49	\$8.05	\$7.69	16	
			RG6	<a href="#">PE4598</a>	\$6.84	\$6.50	\$6.16	\$5.88	17	
			RG11*, RG216*, RG144*	<a href="#">PE4600</a>	\$21.58	\$20.50	\$19.42	\$18.56	18	
			RG179, RG187	<a href="#">PE4604</a>	\$13.44	\$12.77	\$12.10	\$11.56	19	
			PE-B150, RG180, RG195	<a href="#">PE4633</a>	\$14.35	\$13.63	\$12.92	\$12.34	20	
	PE-B305	<a href="#">PE4634</a>	\$15.50	\$14.73	\$13.95	\$13.33	21			
		Clamp/Solder	RG6	<a href="#">PE4597</a>	\$24.32	\$23.10	\$21.89	\$20.92	22	
			RG11*, RG144*, RG216*	<a href="#">PE4599</a>	\$34.74	\$33.00	\$31.27	\$29.88	23	
			RG59*, RG62*, RG71	<a href="#">PE4601</a>	\$16.58	\$15.75	\$14.92	\$14.26	24	
			RG179, RG187	<a href="#">PE4603</a>	\$15.30	\$14.54	\$13.77	\$13.16	25	
		Compression	PE-B159, 1855A, Mini 59	<a href="#">PE44577</a>	\$13.67	\$12.99	\$12.30	\$11.76	26	
			Mini 59, PE-B159	<a href="#">PE44578</a>	\$15.84	\$15.05	\$14.26	\$13.62	27	
	<b>Male, Bulkhead Mount</b>									
	Terminal		Solder	Solder Cup with .350 inch D Hole	<a href="#">PE4627</a>	\$21.64	\$20.56	\$19.48	\$18.61	28
	<b>Male, 4 Hole Flange Mount</b>									
	Terminal		Solder	Solder Cup with .531 inch Hole Spacing	<a href="#">PE4625</a>	\$20.13	\$19.12	\$18.12	\$17.31	29
<b>Male Right Angle</b>										
Cable Connectors		Crimp/Solder	RG59*, RG62*, RG71	<a href="#">PE4608</a>	\$30.89	\$29.35	\$27.80	\$26.57	30	
			RG179, RG187	<a href="#">PE4610</a>	\$24.66	\$23.43	\$22.19	\$21.21	31	
		Clamp/Solder	RG6	<a href="#">PE4605</a>	\$36.30	\$34.49	\$32.67	\$31.22	32	
			RG59*, RG62*, RG71	<a href="#">PE4607</a>	\$45.41	\$43.14	\$40.87	\$39.05	33	
			RG179, RG187	<a href="#">PE4609</a>	\$51.23	\$48.67	\$46.11	\$44.06	34	
<b>Female</b>										
Cable Connectors		Crimp/Solder	735A	<a href="#">PE44688</a>	\$26.44	\$25.12	\$23.80	\$22.74	35	
			RG179, RG187	<a href="#">PE4616</a>	\$18.55	\$17.62	\$16.70	\$15.95	36	
		Clamp/Solder	RG6	<a href="#">PE4611</a>	\$45.83	\$43.54	\$41.25	\$39.41	37	
			RG59*	<a href="#">PE4613</a>	\$20.67	\$19.64	\$18.60	\$17.78	38	
			RG179, RG187	<a href="#">PE4615</a>	\$27.69	\$26.58	\$25.75	\$25.20	39	
PCB Mount		Solder	End Launch	<a href="#">PE44619</a>	\$10.31	\$9.79	\$9.28	\$8.87	40	

\* Fits MIL-C-17 and equivalent cable versions only

Connectors

See Our Website For Current Pricing & Real-Time Stock Availability!



## 75 Ohm BNC Connectors

Connection Method	Product Image	Attachment Cable/Contact	Coax Type / Termination Type	Model No.	PRICE				ROW
					1-24	25-49	50-99	100 +	
<b>Female, Bulkhead Mount</b>									
Cable Connectors		Crimp/Solder	PE-B159, 1855A, Mini 59 with .480 inch D Hole	<a href="#">PE44587</a>	\$22.29	\$21.18	\$20.06	\$19.17	41
			735A with .480 inch D Hole	<a href="#">PE44687</a>	\$28.27	\$26.86	\$25.44	\$24.31	42
			RG59*, RG62*, RG71 with .480 inch D Hole	<a href="#">PE4638</a>	\$29.47	\$28.00	\$26.52	\$25.34	43
			RG179, RG187 with .480 inch D Hole	<a href="#">PE4640</a>	\$22.54	\$21.41	\$20.29	\$19.38	44
			PE-B150, RG180, RG195 with .480 inch D Hole	<a href="#">PE4641</a>	\$27.47	\$26.10	\$24.72	\$23.62	45
		Clamp/Solder	PE-B305 with .480 inch D Hole	<a href="#">PE4642</a>	\$31.46	\$29.89	\$28.31	\$27.06	46
			RG6 with .480 inch D Hole	<a href="#">PE4635</a>	\$50.82	\$48.28	\$45.74	\$43.71	47
			RG59*, RG62*, RG71 with .480 inch D Hole	<a href="#">PE4637</a>	\$35.38	\$33.61	\$31.84	\$30.43	48
			RG179, RG187 with .480 inch D Hole	<a href="#">PE4639</a>	\$33.75	\$32.40	\$31.39	\$30.71	49
PCB Mount		Solder	End Launch with .500 inch Diameter	<a href="#">PE44620</a>	\$16.89	\$16.05	\$15.20	\$14.53	50
Terminal		Solder	Solder Cup with .410 inch D Hole	<a href="#">PE4619</a>	\$10.57	\$10.04	\$9.51	\$9.09	51
			Solder Cup with .350 inch D Hole	<a href="#">PE4620</a>	\$14.80	\$14.06	\$13.32	\$12.73	52
			Turret with .480 inch D Hole	<a href="#">PE4621</a>	\$44.64	\$42.41	\$40.18	\$38.39	53
			Turret with .350 inch D Hole	<a href="#">PE4624</a>	\$36.27	\$34.46	\$32.64	\$31.19	54
			Solder Cup with .350 inch D Hole	<a href="#">PE4626</a>	\$12.84	\$12.20	\$11.56	\$11.04	55
<b>Female, 4 Hole Flange Mount</b>									
Cable Connectors		Clamp/Solder	RG179, RG187 with .500 inch Threaded Hole Spacing	<a href="#">PE44652</a>	\$34.70	\$32.97	\$31.23	\$29.84	56
			RG59*, RG62*, RG71 with .500 inch Threaded Hole Spacing	<a href="#">PE4623</a>	\$36.20	\$34.39	\$32.58	\$31.13	57
Terminal		Solder	Solder Cup with .500 inch Threaded Hole Spacing	<a href="#">PE4617</a>	\$15.79	\$15.00	\$14.21	\$13.58	58
			Turret with .531 inch Hole Spacing	<a href="#">PE4618</a>	\$44.11	\$41.90	\$39.70	\$37.93	59
			Solder Cup with .500 inch Hole Spacing	<a href="#">PE4630</a>	\$19.79	\$18.80	\$17.81	\$17.02	60
			Solder Cup with .718 inch Hole Spacing	<a href="#">PE4631</a>	\$27.35	\$25.98	\$24.62	\$23.52	61
<b>Female Right Angle, Bulkhead Mount</b>									
Terminal		Solder	Solder Cup with .361 inch D Hole	<a href="#">PE4622</a>	\$54.99	\$52.24	\$49.49	\$47.29	62
<b>Female Right Angle, 4 Hole Flange Mount</b>									
Terminal		Solder	Solder Cup with .531 inch Hole Spacing	<a href="#">PE4628</a>	\$25.79	\$24.50	\$23.21	\$22.18	63

Connectors











See Our Website For Current Pricing & Real-Time Stock Availability!

## 75 Ohm F Connectors



Connection Method	Product Image	Attachment Cable/Contact	Coax Type / Termination Type	Model No.	PRICE				ROW
					1-24	25-49	50-99	100 +	
<b>Male</b>									
Cable Connectors		Crimp/Crimp	RG6	<a href="#">PE44312</a>	\$2.24	\$2.13	\$2.02	\$1.93	64
			RG59*, RG62*, RG71	<a href="#">PE44317</a>	\$5.28	\$5.02	\$4.75	\$4.54	65
		Crimp/Solder	RG6-CATV	<a href="#">PE44313</a>	\$5.23	\$4.97	\$4.71	\$4.50	66
			RG11*, RG216*, RG144*	<a href="#">PE44315</a>	\$6.52	\$6.19	\$5.87	\$5.61	67
			RG59*, RG62*, RG71	<a href="#">PE44316</a>	\$1.37	\$1.30	\$1.23	\$1.18	68
			RG6-CATV	<a href="#">PE44452</a>	\$2.68	\$2.55	\$2.41	\$2.30	69
			PE-B159, 1855A, Mini 59	<a href="#">PE44582</a>	\$5.61	\$5.33	\$5.05	\$4.82	70
		Compression	RG179, RG187	<a href="#">PE45520</a>	\$3.85	\$3.66	\$3.47	\$3.31	71
			PE-B159, 1855A, Mini 59	<a href="#">PE44572</a>	\$6.25	\$5.94	\$5.63	\$5.38	72
			PE-B159, 1855A, Mini 59	<a href="#">PE44573</a>	\$5.44	\$5.17	\$4.90	\$4.68	73
		Twist	RG6	<a href="#">PE44314</a>	\$2.46	\$2.34	\$2.21	\$2.12	74
			RG59*, RG62*, RG71	<a href="#">PE44318</a>	\$1.58	\$1.50	\$1.42	\$1.36	75
		Crimp/Non-Solder Contact		LMR-400-75	<a href="#">EZ-400-FM-75</a>	\$27.50	\$27.50	\$27.50	\$27.50

\* Fits MIL-C-17 and equivalent cable versions only

## 75 Ohm F Connectors

Connection Method	Product Image	Attachment Cable/Contact	Coax Type / Termination Type	Model No.	PRICE				ROW
					1-24	25-49	50-99	100 +	
<b>Male Right Angle</b>									
Cable Connectors		Crimp/Solder	RG6-CATV	<a href="#">PE44320</a>	\$9.34	\$8.87	\$8.41	\$8.03	77
			RG59*, RG62*, RG71	<a href="#">PE44322</a>	\$7.60	\$7.22	\$6.84	\$6.54	78
		Compression	PE-B159, 1855A, Mini 59	<a href="#">PE44579</a>	\$12.88	\$12.24	\$11.59	\$11.08	79
		Twist	RG59*, RG62*, RG71	<a href="#">PE44323</a>	\$5.80	\$5.51	\$5.22	\$4.99	80
<b>Female</b>									
PCB Mount		Solder	Thru Hole with .320 inch x .091 inch Hole Spacing	<a href="#">PE44331</a>	\$2.15	\$2.04	\$1.94	\$1.85	81
<b>Female, Bulkhead Mount</b>									
Cable Connectors		Crimp/Solder	RG6-CATV	<a href="#">PE44324</a>	\$8.42	\$8.00	\$7.58	\$7.24	82
			PE-B159, 1855A, Mini 59 with .480 inch D Hole	<a href="#">PE44585</a>	\$6.94	\$6.59	\$6.25	\$5.97	83
			RG179, RG187 with .380 inch DD Hole	<a href="#">PE45504</a>	\$6.49	\$6.23	\$6.04	\$5.91	84
			RG59*, RG62*, RG71	<a href="#">PE45552</a>	\$5.04	\$4.79	\$4.54	\$4.33	85
Terminal		Solder	Tab with .380 inch DD Hole	<a href="#">PE44327</a>	\$1.64	\$1.56	\$1.48	\$1.41	86
PCB Mount			Thru Hole with .340 inch x .091 inch Hole Spacing	<a href="#">PE44332</a>	\$5.58	\$5.30	\$5.02	\$4.80	87
<b>Female, 4 Hole Flange Mount</b>									
Terminal		Solder	Pin with .500 inch Hole Spacing	<a href="#">PE44329</a>	\$9.40	\$8.93	\$8.46	\$8.08	88
<b>Female, Thread-In</b>									
Terminal		Solder	Pin with .380 inch Diameter	<a href="#">PE44330</a>	\$2.58	\$2.45	\$2.32	\$2.22	89
<b>Female Right Angle</b>									
PCB Mount		Solder	Thru Hole with .320 inch x .091 inch Hole Spacing	<a href="#">PE44333</a>	\$6.68	\$6.35	\$6.01	\$5.74	90
<b>Female Right Angle, Bulkhead Mount</b>									
PCB Mount		Solder	Thru Hole with .350 inch D Hole	<a href="#">PE44334</a>	\$8.17	\$7.76	\$7.35	\$7.03	91
			Surface Mount	<a href="#">PE44895</a>	\$14.69	\$13.96	\$13.22	\$12.63	92

## 75 Ohm MCX Connectors





Connection Method	Product Image	Attachment Cable/Contact	Coax Type / Termination Type	Model No.	PRICE				ROW
					1-24	25-49	50-99	100 +	
<b>Plug</b>									
Cable Connectors		Crimp/Solder	RG179, RG187	<a href="#">PE44298</a>	\$14.02	\$13.32	\$12.62	\$12.06	93
PCB Mount		Solder	Thru Hole with .200 inch x .055 inch Hole Spacing	<a href="#">PE44307</a>	\$19.62	\$18.64	\$17.66	\$16.87	94

\* Fits MIL-C-17 and equivalent cable versions only







Connectors

See Our Website For Current Pricing & Real-Time Stock Availability!

## 75 Ohm MCX Connectors

Connection Method	Product Image	Attachment Cable/Contact	Coax Type / Termination Type	Model No.	PRICE				ROW
					1-24	25-49	50-99	100 +	
<b>Plug Right Angle</b>									
Cable Connectors		Crimp/Solder	RG179, RG187	<a href="#">PE45086</a>	\$17.13	\$16.27	\$15.42	\$14.73	95
<b>Jack</b>									
Cable Connectors		Crimp/Solder	RG179, RG187	<a href="#">PE44300</a>	\$26.34	\$25.02	\$23.71	\$22.65	96
PCB Mount		Solder	.072 inch End Launch	<a href="#">PE45211</a>	\$12.05	\$11.45	\$10.85	\$10.36	97
<b>Jack Right Angle</b>									
PCB Mount		Solder	Thru Hole with .200 inch x .055 inch Hole Spacing	<a href="#">PE44304</a>	\$17.29	\$16.43	\$15.56	\$14.87	98

## 75 Ohm Mini SMB Connectors

Connection Method	Product Image	Attachment Cable/Contact	Coax Type / Termination Type	Model No.	PRICE				ROW
					1-24	25-49	50-99	100 +	
<b>Plug</b>									
Cable Connectors		Crimp/Solder	PE-B159, 1855A, Mini 59	<a href="#">PE44588</a>	\$21.76	\$20.67	\$19.58	\$18.71	99
			RG179, RG187	<a href="#">PE4993</a>	\$17.63	\$16.75	\$15.87	\$15.16	1
			RG59*, RG62*, RG71	<a href="#">PE4994</a>	\$28.80	\$27.65	\$26.78	\$26.21	2
<b>Plug Right Angle</b>									
Cable Connectors		Crimp/Solder	RG179, RG187	<a href="#">PE4995</a>	\$20.84	\$19.80	\$18.76	\$17.92	3
			RG59*, RG62*, RG71	<a href="#">PE4996</a>	\$25.64	\$24.36	\$23.08	\$22.05	4
<b>Jack</b>									
Cable Connectors		Crimp/Solder	Mini 59, PE-B159	<a href="#">PE44590</a>	\$26.57	\$25.24	\$23.91	\$22.85	5
PCB Mount		Solder	.062 inch End Launch	<a href="#">PE44131</a>	\$24.82	\$23.58	\$22.34	\$21.35	6
			.042 inch End Launch	<a href="#">PE44134</a>	\$19.62	\$18.64	\$17.66	\$16.87	7
			Thru Hole with .200 inch x .055 inch Hole Spacing	<a href="#">PE4997</a>	\$16.80	\$15.96	\$15.12	\$14.45	8
<b>Jack, Bulkhead Mount</b>									
PCB Mount		Solder	Thru Hole with .177 inch D Hole	<a href="#">PE44125</a>	\$53.94	\$51.24	\$48.55	\$46.39	9
<b>Jack, 2 Hole Flange Mount</b>									
Terminal		Solder	Solder Cup with .328 inch Hole Spacing	<a href="#">PE44141</a>	\$23.79	\$22.60	\$21.41	\$20.46	10
<b>Jack Right Angle</b>									
PCB Mount		Solder	Thru Hole with .200 inch x .055 inch Hole Spacing	<a href="#">PE4998</a>	\$23.91	\$22.71	\$21.52	\$20.56	11
<b>Jack Right Angle, Bulkhead Mount</b>									
PCB Mount		Solder	Thru Hole with .177 inch D Hole	<a href="#">PE44128</a>	\$25.16	\$23.90	\$22.64	\$21.64	12









Connectors

See Our Website For Current Pricing & Real-Time Stock Availability!





\* Fits MIL-C-17 and equivalent cable versions only



## 75 Ohm N Connectors

Connection Method	Product Image	Attachment Cable/Contact	Coax Type / Termination Type	Model No.	PRICE				ROW
					1-24	25-49	50-99	100 +	
<b>Male</b>									
Cable Connectors		Crimp/Solder	RG6	<a href="#">PE4508</a>	\$23.89	\$22.70	\$21.50	\$20.55	13
			RG11*, RG144*, RG216*	<a href="#">PE4510</a>	\$24.34	\$23.12	\$21.91	\$20.93	14
			RG59*, RG62*, RG71	<a href="#">PE4512</a>	\$24.11	\$22.90	\$21.70	\$20.73	15
			RG179, RG187	<a href="#">PE4656</a>	\$37.33	\$35.46	\$33.60	\$32.10	16
		Clamp/Solder	RG6	<a href="#">PE4507</a>	\$22.60	\$21.47	\$20.34	\$19.44	17
			RG11*, RG144*, RG216*	<a href="#">PE4509</a>	\$35.78	\$34.35	\$33.28	\$32.56	18
			RG59*, RG62*, RG71	<a href="#">PE4511</a>	\$23.01	\$21.86	\$20.71	\$19.79	19
			RG179, RG187	<a href="#">PE4513</a>	\$20.50	\$19.48	\$18.45	\$17.63	20
		Crimp/Non-Solder Contact	LMR-400-75	<a href="#">EZ-400-NMH-75-X</a>	\$36.99	\$36.99	\$36.99	\$36.99	21
	<b>Male, 4 Hole Flange Mount</b>								
Terminal		Solder	Solder Cup with .718 inch Hole Spacing	<a href="#">PE4504</a>	\$24.82	\$23.58	\$22.34	\$21.35	22
<b>Male Right Angle</b>									
Cable Connectors		Clamp/Solder	RG11*, RG144*, RG216*	<a href="#">PE4502</a>	\$52.70	\$50.59	\$49.01	\$47.96	23
<b>Female</b>									
Cable Connectors		Clamp/Solder	RG6	<a href="#">PE4514</a>	\$43.14	\$41.41	\$40.12	\$39.26	24
			RG11*, RG144*, RG216* with .480 inch D Hole	<a href="#">PE4515</a>	\$33.35	\$31.68	\$30.02	\$28.68	25
			RG59*, RG62*, RG71	<a href="#">PE4516</a>	\$36.86	\$35.02	\$33.17	\$31.70	26
<b>Female, Bulkhead Mount</b>									
Terminal		Solder	Solder Cup with .640 inch DD Hole	<a href="#">PE4505</a>	\$28.17	\$26.76	\$25.35	\$24.23	27
			Solder Cup with .380 inch Diameter	<a href="#">PE4506</a>	\$18.13	\$17.22	\$16.32	\$15.59	28
<b>Female, 4 Hole Flange Mount</b>									
Terminal		Solder	Solder Cup with .718 inch Hole Spacing	<a href="#">PE4503</a>	\$16.98	\$16.13	\$15.28	\$14.60	29

## 75 Ohm RCA Connectors















Connection Method	Product Image	Attachment Cable/Contact	Coax Type / Termination Type	Model No.	PRICE				ROW
					1-24	25-49	50-99	100 +	
<b>Male</b>									
Cable Connectors		Crimp/Solder	PE-B159	<a href="#">PE44583</a>	\$13.56	\$12.88	\$12.20	\$11.66	30
			Mini 59, PE-B159	<a href="#">PE44622</a>	\$14.35	\$13.63	\$12.92	\$12.34	31
			1694A	<a href="#">PE44623</a>	\$11.71	\$11.12	\$10.54	\$10.07	32
			1505A	<a href="#">PE44624</a>	\$14.35	\$13.63	\$12.92	\$12.34	33
		Compression	PE-B159, 1855A, Mini 59	<a href="#">PE44574</a>	\$12.67	\$12.04	\$11.40	\$10.90	34
			Mini 59, PE-B159	<a href="#">PE44576</a>	\$6.68	\$6.35	\$6.01	\$5.74	35
<b>Male Right Angle</b>									
Cable Connectors		Compression	Mini 59, PE-B159	<a href="#">PE44580</a>	\$17.28	\$16.42	\$15.55	\$14.86	36
<b>Female, Bulkhead Mount</b>									
Cable Connectors		Crimp/Solder	PE-B159, 1855A, Mini 59 with .480 inch D Hole	<a href="#">PE44586</a>	\$17.43	\$16.56	\$15.69	\$14.99	37

\* Fits MIL-C-17 and equivalent cable versions only

Connectors

See Our Website For Current Pricing & Real-Time Stock Availability!

# 75 Ohm SMB Connectors



Connection Method	Product Image	Attachment Cable/Contact	Coax Type / Termination Type	Model No.	PRICE				ROW
					1-24	25-49	50-99	100 +	
<b>Plug</b>									
Cable Connectors		Crimp/Solder	PE-B150, RG180, RG195	<a href="#">PE4157</a>	\$25.70	\$24.42	\$23.13	\$22.10	38
			RG179, RG187	<a href="#">PE4248</a>	\$19.74	\$18.75	\$17.77	\$16.98	39
			RG59*, RG62*, RG71	<a href="#">PE4472</a>	\$24.32	\$23.10	\$21.89	\$20.92	40
		Clamp/Solder	RG59*, RG62*, RG71	<a href="#">PE4203</a>	\$18.94	\$17.99	\$17.05	\$16.29	41
RG179, RG187			<a href="#">PE4257</a>	\$24.97	\$23.72	\$22.47	\$21.47	42	
PCB Mount		Solder	Thru Hole with .200 inch x .067 inch Hole Spacing	<a href="#">PE4368</a>	\$19.06	\$18.30	\$17.73	\$17.34	43
<b>Plug, Bulkhead Mount</b>									
Terminal		Solder	Solder Cup with .295 inch D Hole	<a href="#">PE4290</a>	\$62.19	\$59.08	\$55.97	\$53.48	44
<b>Plug Right Angle</b>									
Cable Connectors		Crimp/Solder	PE-B150, RG180, RG195	<a href="#">PE4161</a>	\$47.87	\$45.96	\$44.52	\$43.56	45
			RG179, RG187	<a href="#">PE4251</a>	\$27.25	\$25.89	\$24.53	\$23.44	46
		Clamp/Solder	RG59*, RG62*	<a href="#">PE4264</a>	\$39.25	\$37.29	\$35.33	\$33.76	47
			RG180, RG195	<a href="#">PE4265</a>	\$21.57	\$20.49	\$19.41	\$18.55	48
PCB Mount		Solder	Thru Hole with .200 inch x .067 inch Hole Spacing	<a href="#">PE4292</a>	\$49.42	\$46.95	\$44.48	\$42.50	49
<b>Jack</b>									
Cable Connectors		Crimp/Solder	PE-B150, RG180, RG195	<a href="#">PE4163</a>	\$20.46	\$19.44	\$18.41	\$17.60	50
			RG179, RG187	<a href="#">PE44872</a>	\$35.28	\$33.52	\$31.75	\$30.34	51
		Clamp/Solder	RG59*, RG62*	<a href="#">PE4272</a>	\$33.86	\$32.17	\$30.47	\$29.12	52
			RG180, RG195	<a href="#">PE4273</a>	\$43.13	\$40.97	\$38.82	\$37.09	53
			RG179, RG187	<a href="#">PE4928</a>	\$44.04	\$41.84	\$39.64	\$37.87	54
PCB Mount		Solder	Thru Hole with .200 inch x .067 inch Hole Spacing	<a href="#">PE4110</a>	\$22.06	\$20.96	\$19.85	\$18.97	55
<b>Jack, Bulkhead Mount</b>									
Cable Connectors		Crimp/Solder	RG179, RG187 with .285 inch D Hole	<a href="#">PE4255</a>	\$47.13	\$44.77	\$42.42	\$40.53	56
		Clamp/Solder	RG59*, RG62* with .177 inch D Hole	<a href="#">PE4280</a>	\$43.38	\$41.21	\$39.04	\$37.31	57
			RG180, RG195 with .285 inch D Hole	<a href="#">PE4281</a>	\$26.81	\$25.47	\$24.13	\$23.06	58
Terminal		Solder	Solder Cup with .317 inch Diameter	<a href="#">PE4168</a>	\$16.35	\$15.53	\$14.72	\$14.06	59
			Solder Cup with .295 inch D Hole	<a href="#">PE4172</a>	\$17.16	\$16.30	\$15.44	\$14.76	60
<b>Jack Right Angle</b>									
PCB Mount		Solder	Thru Hole with .200 inch x .067 inch Hole Spacing	<a href="#">PE4179</a>	\$23.91	\$22.71	\$21.52	\$20.56	61
<b>Jack Right Angle, Bulkhead Mount</b>									
Terminal		Solder	Solder Cup with .295 inch D Hole	<a href="#">PE4286</a>	\$60.51	\$57.48	\$54.46	\$52.04	62

Connectors









See Our Website For Current Pricing & Real-Time Stock Availability!

\* Fits MIL-C-17 and equivalent cable versions only

## 75 Ohm SMB Positive Snap Connectors

Connection Method	Product Image	Attachment Cable/Contact	Coax Type / Termination Type	Model No.	PRICE				ROW
					1-24	25-49	50-99	100 +	
	<b>Plug</b>								
Cable Connectors		Crimp/Solder	RG59*, RG62*	<a href="#">PE44442</a>	\$21.57	\$20.49	\$19.41	\$18.55	63
			RG179, RG187	<a href="#">PE44443</a>	\$31.35	\$29.78	\$28.22	\$26.96	64
	<b>Plug Right Angle</b>								
Cable Connectors		Crimp/Solder	RG179, RG187	<a href="#">PE44445</a>	\$34.48	\$32.76	\$31.03	\$29.65	65
			RG180, RG195	<a href="#">PE44446</a>	\$47.43	\$45.06	\$42.69	\$40.79	66

## 75 Ohm SMC Connectors

Connection Method	Product Image	Attachment Cable/Contact	Coax Type / Termination Type	Model No.	PRICE				ROW
					1-24	25-49	50-99	100 +	
	<b>Plug</b>								
Cable Connectors		Crimp/Solder	PE-B150, RG180, RG195	<a href="#">PE4158</a>	\$26.36	\$25.04	\$23.72	\$22.67	67
			RG179, RG187	<a href="#">PE4249</a>	\$21.26	\$20.20	\$19.13	\$18.28	68
		Clamp/Solder	RG59*, RG62*, RG71	<a href="#">PE4658</a>	\$27.40	\$26.03	\$24.66	\$23.56	69
			RG179, RG187	<a href="#">PE4259</a>	\$44.04	\$41.84	\$39.64	\$37.87	71
	<b>Plug, Bulkhead Mount</b>								
Terminal		Solder	Solder Cup with .295 inch D Hole	<a href="#">PE4291</a>	\$45.36	\$43.09	\$40.82	\$39.01	72
	<b>Plug Right Angle</b>								
Cable Connectors		Crimp/Solder	RG180, RG195	<a href="#">PE4162</a>	\$36.57	\$34.74	\$32.91	\$31.45	73
			RG179, RG187	<a href="#">PE4252</a>	\$33.31	\$31.64	\$29.98	\$28.65	74
		Clamp/Solder	RG59*, RG62*	<a href="#">PE4266</a>	\$30.17	\$28.66	\$27.15	\$25.95	75
PCB Mount			Solder	Thru Hole with .200 inch x .067 inch Hole Spacing	<a href="#">PE4293</a>	\$45.00	\$42.75	\$40.50	\$38.70
	<b>Jack</b>								
Cable Connectors		Crimp/Solder	RG180, RG195	<a href="#">PE4164</a>	\$29.54	\$28.36	\$27.47	\$26.88	77
			RG179, RG187	<a href="#">PE4254</a>	\$38.64	\$37.09	\$35.94	\$35.16	78
		Clamp/Solder	RG59*, RG62*	<a href="#">PE4274</a>	\$38.37	\$36.45	\$34.53	\$33.00	79
RG180, RG195	<a href="#">PE4275</a>		\$32.20	\$30.59	\$28.98	\$27.69	80		
PCB Mount		Solder	Thru Hole with .200 inch x .067 inch Hole Spacing	<a href="#">PE4176</a>	\$20.29	\$19.48	\$18.87	\$18.46	81
	<b>Jack, Bulkhead Mount</b>								
Cable Connectors		Crimp/Solder	RG179, RG187 with .285 inch D Hole	<a href="#">PE4256</a>	\$34.14	\$32.43	\$30.73	\$29.36	82
			RG180, RG195 with .285 inch D Hole	<a href="#">PE4283</a>	\$28.69	\$27.26	\$25.82	\$24.67	83
		Clamp/Solder	RG179, RG187	<a href="#">PE4906</a>	\$41.25	\$39.19	\$37.13	\$35.48	84
Terminal		Solder	Solder Cup with .295 inch D Hole	<a href="#">PE4169</a>	\$45.05	\$42.80	\$40.55	\$38.74	85
			Solder Cup with .295 inch D Hole	<a href="#">PE4173</a>	\$31.47	\$29.90	\$28.32	\$27.06	86

\* Fits MIL-C-17 and equivalent cable versions only







Connectors

See Our Website For Current Pricing & Real-Time Stock Availability!



## 75 Ohm SMC Connectors

Connection Method	Product Image	Attachment Cable/Contact	Coax Type / Termination Type	Model No.	PRICE				ROW
					1-24	25-49	50-99	100 +	
	<b>Jack Right Angle</b>								
PCB Mount		Solder	Thru Hole with .200 inch x .067 inch Hole Spacing	<a href="#">PE4180</a>	\$39.79	\$37.80	\$35.81	\$34.22	87

## 75 Ohm TNC Connectors





Connection Method	Product Image	Attachment Cable/Contact	Coax Type / Termination Type	Model No.	PRICE				ROW
					1-24	25-49	50-99	100 +	
	<b>Male</b>								
Cable Connectors		Crimp/Solder	RG6	<a href="#">PE44162</a>	\$20.67	\$19.64	\$18.60	\$17.78	88
			RG11*, RG144*	<a href="#">PE44164</a>	\$42.14	\$40.03	\$37.93	\$36.24	89
			RG59*, RG62*	<a href="#">PE44166</a>	\$17.89	\$17.00	\$16.10	\$15.39	90
			RG179, RG187	<a href="#">PE44168</a>	\$18.22	\$17.31	\$16.40	\$15.67	91
		Clamp/Solder	RG6	<a href="#">PE44161</a>	\$26.00	\$24.96	\$24.18	\$23.66	92
			RG11*, RG144*, RG216*	<a href="#">PE44163</a>	\$58.56	\$55.63	\$52.70	\$50.36	93
			RG59*	<a href="#">PE44165</a>	\$17.89	\$17.00	\$16.10	\$15.39	94
			RG179, RG187	<a href="#">PE44167</a>	\$17.89	\$17.00	\$16.10	\$15.39	95
	<b>Male Right Angle</b>								
Cable Connectors		Clamp/Solder	RG59*, RG62*, RG71	<a href="#">PE44171</a>	\$57.69	\$54.81	\$51.92	\$49.61	96
			RG179, RG187	<a href="#">PE44172</a>	\$54.94	\$52.19	\$49.45	\$47.25	97
	<b>Female, Bulkhead Mount</b>								
Cable Connectors		Clamp/Solder	RG6 with .480 inch D Hole	<a href="#">PE44173</a>	\$43.53	\$41.35	\$39.18	\$37.44	98
			RG11*, RG216* with .480 inch D Hole	<a href="#">PE44174</a>	\$45.56	\$43.28	\$41.00	\$39.18	99
			RG59*, RG62*, RG71 with .480 inch D Hole	<a href="#">PE44175</a>	\$51.35	\$48.78	\$46.22	\$44.16	1
			RG179, RG187 with .480 inch D Hole	<a href="#">PE44176</a>	\$46.61	\$44.28	\$41.95	\$40.08	2
Terminal		Solder	Solder Cup with .410 inch D Hole	<a href="#">PE44177</a>	\$21.26	\$20.20	\$19.13	\$18.28	3
			Solder Cup with .480 inch D Hole	<a href="#">PE44181</a>	\$27.37	\$26.00	\$24.63	\$23.54	4
	<b>Female, 4 Hole Flange Mount</b>								
Terminal		Solder	Solder Cup with .500 inch Threaded Hole Spacing	<a href="#">PE44178</a>	\$19.79	\$18.80	\$17.81	\$17.02	5

## BNC Twinax Connectors





Connection Method	Product Image	Attachment Cable/Contact	Coax Type / Termination Type	Model No.	PRICE				ROW
					1-24	25-49	50-99	100 +	
	<b>Plug</b>								
Cable Connectors		Crimp/Solder	RG108, 78 Ohm Twinax	<a href="#">PE4234</a>	\$21.30	\$20.24	\$19.17	\$18.32	6
		Clamp/Solder	RG108, 78 Ohm Twinax	<a href="#">PE4236</a>	\$28.16	\$26.75	\$25.34	\$24.22	7
	<b>Jack</b>								
Cable Connectors		Crimp/Solder	RG108, 78 Ohm Twinax	<a href="#">PE4235</a>	\$40.64	\$38.61	\$36.58	\$34.95	8
		Clamp/Solder	RG108, 78 Ohm Twinax	<a href="#">PE4237</a>	\$35.24	\$33.48	\$31.72	\$30.31	9
PCB Mount		Solder	Thru Hole with .687 inch x .500 inch Hole Spacing	<a href="#">PE44115</a>	\$31.73	\$30.46	\$29.51	\$28.87	10

\* Fits MIL-C-17 and equivalent cable versions only

## BNC Twinax Connectors

Connection Method	Product Image	Attachment Cable/Contact	Coax Type / Termination Type	Model No.	PRICE				ROW
					1-24	25-49	50-99	100 +	
<b>Jack, Bulkhead Mount</b>									
Cable Connectors		Clamp/Solder	RG108, 78 Ohm Twinax with .480 inch D Hole	<a href="#">PE44114</a>	\$48.96	\$46.51	\$44.06	\$42.11	11
Terminal		Solder	Solder Cup with .350 inch D Hole	<a href="#">PE4238</a>	\$19.91	\$18.91	\$17.92	\$17.12	12
<b>Jack, 4 Hole Flange Mount</b>									
Terminal		Solder	Solder Cup with .500 inch Threaded Hole Spacing	<a href="#">PE4324</a>	\$33.39	\$31.72	\$30.05	\$28.72	13
<b>Jack Right Angle</b>									
PCB Mount		Solder	Thru Hole with .687 inch x .500 inch Hole Spacing	<a href="#">PE44116</a>	\$48.75	\$46.31	\$43.88	\$41.93	14

## 3/4"-20 Twinax Connectors

Connection Method	Product Image	Attachment Cable/Contact	Coax Type / Termination Type	Model No.	PRICE				ROW
					1-24	25-49	50-99	100 +	
<b>Male</b>									
Cable Connectors		Clamp/Solder	PE-S330	<a href="#">PE4104</a>	\$24.87	\$23.63	\$22.38	\$21.39	15
<b>Female</b>									
Cable Connectors		Clamp/Solder	PE-S330	<a href="#">PE4346</a>	\$25.82	\$24.53	\$23.24	\$22.21	16
<b>Female, Bulkhead Mount</b>									
Terminal		Solder	Solder Cup with .720 inch D Hole	<a href="#">PE4105</a>	\$26.83	\$25.49	\$24.15	\$23.07	17
<b>Female, 4 Hole Flange Mount</b>									
Terminal		Solder	Solder Cup with .718 inch Hole Spacing	<a href="#">PE4347</a>	\$31.90	\$30.31	\$28.71	\$27.43	18

## Banana Connectors

Connection Method	Product Image	Attachment Cable/Contact	Coax Type / Termination Type	Model No.	PRICE				ROW
					1-24	25-49	50-99	100 +	
<b>Plug</b>									
Cable Connectors		Crimp/Solder	RG188-DS, RG316-DS	<a href="#">PE45164</a>	\$14.70	\$13.97	\$13.23	\$12.64	19
			RG65, RG142, RG223, RG400	<a href="#">PE4089</a>	\$9.96	\$9.46	\$8.96	\$8.57	20

## Double Banana Connectors

Connection Method	Product Image	Attachment Cable/Contact	Coax Type / Termination Type	Model No.	PRICE				ROW
					1-24	25-49	50-99	100 +	
<b>Plug</b>									
Cable Connectors		Crimp/Solder	RG174, RG316, RG188, .100 inch, PE-B100, PE-C100, LMR-100	<a href="#">PE44145</a>	\$13.59	\$12.91	\$12.23	\$11.69	21
			PE-C195, PE-P195, RG58, RG141, RG303, LMR-195, .195 inch	<a href="#">PE4301</a>	\$10.44	\$9.92	\$9.40	\$8.98	22

\* Fits MIL-C-17 and equivalent cable versions only

Connectors

See Our Website For Current Pricing & Real-Time Stock Availability!



# CONNECTOR DUST CAPS

## Non-Shorting Caps



Connector	Gender	Compatible With	Chain	Model No	1-24	25-49	50-99	100+	ROW
7/16 DIN	Male	50 Ohm	Yes	<a href="#">PE6057</a>	\$43.25	\$41.09	\$38.93	\$37.20	1
	Female		Yes	<a href="#">PE6058</a>	\$53.20	\$50.54	\$47.88	\$45.75	2
BNC	Male		Yes	<a href="#">PE6013</a>	\$8.90	\$8.46	\$8.01	\$7.65	3
	Female		No	<a href="#">PE6014</a>	\$4.98	\$4.73	\$4.48	\$4.28	4
C			Male	Yes	<a href="#">PE6015</a>	\$7.26	\$6.90	\$6.53	\$6.24
	Female		No	<a href="#">PE6108</a>	\$10.68	\$10.15	\$9.61	\$9.18	6
F	Male		Yes	<a href="#">PE6046</a>	\$22.52	\$21.39	\$20.27	\$19.37	7
	Female		No	<a href="#">PE6109</a>	\$28.89	\$27.45	\$26.00	\$24.85	8
HN	Male		Yes	<a href="#">PE6110</a>	\$28.93	\$27.48	\$26.04	\$24.88	9
	Female		No	<a href="#">PE6111</a>	\$21.69	\$20.61	\$19.52	\$18.65	10
N	Male	No	<a href="#">PE6240</a>	\$3.61	\$3.43	\$3.25	\$3.10	11	
	Female	Yes	<a href="#">PE6059</a>	\$29.39	\$27.92	\$26.45	\$25.28	12	
SC		Male	No	<a href="#">PE6113</a>	\$21.01	\$19.96	\$18.91	\$18.07	13
	Female	Yes	<a href="#">PE6114</a>	\$28.78	\$27.34	\$25.90	\$24.75	14	
SMA	Male	No	<a href="#">PE6115</a>	\$29.36	\$27.89	\$26.42	\$25.25	15	
	Female	Yes	<a href="#">PE6016</a>	\$7.36	\$6.99	\$6.62	\$6.33	16	
SMB	Male	No	<a href="#">PE6017</a>	\$8.00	\$7.60	\$7.20	\$6.88	17	
	Female	Yes	<a href="#">PE6018</a>	\$11.30	\$10.74	\$10.17	\$9.72	18	
SMC	Male	No	<a href="#">PE6116</a>	\$9.77	\$9.28	\$8.79	\$8.40	19	
	Female	Yes	<a href="#">PE6117</a>	\$42.14	\$40.03	\$37.93	\$36.24	20	
SSMA	Male	Yes	<a href="#">PE6118</a>	\$33.06	\$31.41	\$29.75	\$28.43	21	
	Female	Yes	<a href="#">PE6019</a>	\$11.79	\$11.20	\$10.61	\$10.14	22	
TNC	Male	No	<a href="#">PE6024</a>	\$3.83	\$3.64	\$3.45	\$3.29	23	
	Female	Yes	<a href="#">PE6119</a>	\$23.42	\$22.25	\$21.08	\$20.14	24	
SMB	Plug	75 Ohm	No	<a href="#">PE6120</a>	\$9.25	\$8.79	\$8.33	\$7.96	25
	Jack	50 Ohm	Yes	<a href="#">PE6121</a>	\$24.90	\$23.66	\$22.41	\$21.41	26
SMC	Plug	75 Ohm	Yes	<a href="#">PE6122</a>	\$39.16	\$37.20	\$35.24	\$33.68	27
	Jack	50 Ohm	Yes	<a href="#">PE6123</a>	\$20.82	\$19.78	\$18.74	\$17.91	28
SSMA	Male	50 Ohm	Yes	<a href="#">PE6124</a>	\$17.87	\$16.98	\$16.08	\$15.37	29
	Female	75 Ohm	Yes	<a href="#">PE6126</a>	\$36.02	\$34.22	\$32.42	\$30.98	30
TNC	Male	50 Ohm	Yes	<a href="#">PE6124</a>	\$16.24	\$15.43	\$14.62	\$13.97	31
	Female	50 Ohm	No	<a href="#">PE6020</a>	\$16.84	\$16.00	\$15.16	\$14.48	32
TNC	Male	50 Ohm	Yes	<a href="#">PE6023</a>	\$10.27	\$9.76	\$9.24	\$8.83	33
	Female	50 Ohm	No	<a href="#">PE6144</a>	\$9.40	\$8.93	\$8.46	\$8.08	34
TNC	Male	50 Ohm	Yes	<a href="#">PE6021</a>	\$12.55	\$11.92	\$11.30	\$10.79	35
	Female	50 Ohm	No	<a href="#">PE6143</a>	\$12.09	\$11.49	\$10.88	\$10.40	36

## Shorting Caps



Connector	Gender	Compatible With	Chain	Model No	1-24	25-49	50-99	100+	ROW	
2.4mm	Male	50 Ohm	Yes	<a href="#">PE6194</a>	\$62.86	\$60.35	\$58.46	\$57.20	37	
	Female		Yes	<a href="#">PE6195</a>	\$75.70	\$71.92	\$68.13	\$65.10	38	
BNC	Male		No	<a href="#">PE6193</a>	\$68.64	\$65.21	\$61.78	\$59.03	39	
	Female		Yes	<a href="#">PE6127</a>	\$23.67	\$22.49	\$21.30	\$20.36	40	
N			Male	No	<a href="#">PE6012</a>	\$7.88	\$7.49	\$7.09	\$6.78	41
	Female		Yes	<a href="#">PE6128</a>	\$25.68	\$24.40	\$23.11	\$22.08	42	
SMA	Male		No	<a href="#">PE6030</a>	\$15.15	\$14.39	\$13.64	\$13.03	43	
	Female		Yes	<a href="#">PE6129</a>	\$30.31	\$28.79	\$27.28	\$26.07	44	
TNC	Male		50 Ohm	No	<a href="#">PE6022</a>	\$21.93	\$20.83	\$19.74	\$18.86	45
	Female		50 Ohm	Yes	<a href="#">PE6130</a>	\$48.43	\$46.01	\$43.59	\$41.65	46
SMA	Male	50 Ohm	No	<a href="#">PE6031</a>	\$10.78	\$10.24	\$9.70	\$9.27	47	
	Female	50 Ohm	Yes	<a href="#">PE6131</a>	\$29.62	\$28.14	\$26.66	\$25.47	48	
TNC	Male	50 Ohm	No	<a href="#">PE6006</a>	\$22.63	\$21.50	\$20.37	\$19.46	49	
	Female	50 Ohm	Yes	<a href="#">PE6132</a>	\$34.03	\$32.33	\$30.63	\$29.27	50	
TNC	Male	50 Ohm	Yes	<a href="#">PE6251</a>	\$24.40	\$23.42	\$22.69	\$22.20	51	
	Female	50 Ohm	No	<a href="#">PE6007</a>	\$25.05	\$23.80	\$22.55	\$21.54	52	
TNC	Male	50 Ohm	No	<a href="#">PE6133</a>	\$23.87	\$22.68	\$21.48	\$20.53	53	
	Female	50 Ohm	Yes	<a href="#">PE6136</a>	\$30.63	\$29.10	\$27.57	\$26.34	54	
TNC	Male	50 Ohm	No	<a href="#">PE6135</a>	\$22.55	\$21.42	\$20.30	\$19.39	55	

\* Fits MIL-C-17 and equivalent cable versions only



Technical Support  
+1 (949) 261-1920



Same-Day Shipping,  
Even Custom  
Cable Assemblies

Connectors

See Our Website For Current Pricing & Real-Time Stock Availability!

## COUPLERS AND HYBRIDS

### Single Directional

#### 1.85mm Connectors



Frequency Range (MHz.)	Coupling (dB)	Maximum Power	Directivity (dB)	Model No	1	2-4	5-9	10+	ROW
1,000-67,000	10	20 Watt	8	<a href="#">PE2CP1127-10</a>	\$5,999.00	\$5,759.04	\$5,519.08	\$5,279.12	1
	20			<a href="#">PE2CP1127-20</a>	\$5,999.00	\$5,759.04	\$5,519.08	\$5,279.12	

#### 2.4mm Connectors



Frequency Range (MHz.)	Coupling (dB)	Maximum Power	Directivity (dB)	Model No	1	2-4	5-9	10+	ROW
2,000-52,000	10	20 Watt	10	<a href="#">PE2CP1134-10</a>	\$3,200.00	\$3,072.00	\$2,944.00	\$2,816.00	2
18,000-50,000	20		8	<a href="#">PE2CP1135-20</a>	\$3,082.37	\$2,959.08	\$2,835.78	\$2,712.49	3

#### 2.92mm Connectors



Frequency Range (MHz.)	Coupling (dB)	Maximum Power	Directivity (dB)	Model No	1	2-4	5-9	10+	ROW
1,000-40,000	20	30 Watt	10	<a href="#">PE2CP1122-20</a>	\$2,076.96	\$1,993.88	\$1,910.80	\$1,827.72	4
	30			<a href="#">PE2CP1122-30</a>	\$2,076.96	\$1,993.88	\$1,910.80	\$1,827.72	
2,000-40,000	20			<a href="#">PE2CP1133-20</a>	\$1,699.00	\$1,631.04	\$1,563.08	\$1,495.12	5
	30			<a href="#">PE2CP1133-30</a>	\$1,765.26	\$1,694.65	\$1,624.04	\$1,553.43	
6,000-40,000	20		<a href="#">PE2CP1124-20</a>	\$1,599.00	\$1,535.04	\$1,471.08	\$1,407.12	6	
8,000-40,000	30		<a href="#">PE2CP1125-20</a>	\$1,566.67	\$1,504.00	\$1,441.34	\$1,378.67	7	
	6		<a href="#">PE2CP1125-30</a>	\$1,566.67	\$1,504.00	\$1,441.34	\$1,378.67		
18,000-40,000	6		<a href="#">PE2CP1126-6</a>	\$1,399.00	\$1,343.04	\$1,287.08	\$1,231.12	8	

#### 4.1/9.5 Mini DIN Connectors



Frequency Range (MHz.)	Coupling (dB)	Maximum Power	Directivity (dB)	Model No	1 Pc. Price	See Web for Volume Pricing	ROW	
698-2,700	6	200 Watt	20	<a href="#">PE2CP1059</a>	\$479.32	See Web for Volume Pricing	9	
	10			<a href="#">PE2CP1063</a>	\$475.84			10
	15			<a href="#">PE2CP1067</a>	\$549.35			11
	20			<a href="#">PE2CP1071</a>	\$475.84			12
	30			<a href="#">PE2CP1075</a>	\$475.84			13

#### 4.3-10 Connectors



Frequency Range (MHz.)	Coupling (dB)	Maximum Power	Directivity (dB)	Model No	1-4	5-9	10-24	25+	ROW
698-2,700	6	200 Watt	20	<a href="#">PE2CP1060</a>	\$521.00	\$494.95	\$468.90	\$448.06	14
	10			<a href="#">PE2CP1064</a>	\$521.00	\$494.95	\$468.90	\$448.06	15
	15			<a href="#">PE2CP1068</a>	\$521.00	\$494.95	\$468.90	\$448.06	16
	20			<a href="#">PE2CP1072</a>	\$521.00	\$494.95	\$468.90	\$448.06	17
	30			<a href="#">PE2CP1076</a>	\$521.00	\$494.95	\$468.90	\$448.06	18

Couplers & Hybrids

### 7/16 DIN Connectors



Frequency Range (MHz.)	Coupling (dB)	Maximum Power	Directivity (dB)	Model No	1-4	5-9	10-24	25+	ROW
698-2,700	6	200 Watt	20	<a href="#">PE2CP1058</a>	\$503.63	\$478.45	\$453.27	\$433.12	19
	10			<a href="#">PE2CP1062</a>	\$581.42	\$552.35	\$523.28	\$500.02	20
	15			<a href="#">PE2CP1066</a>	\$581.42	\$552.35	\$523.28	\$500.02	21
	20			<a href="#">PE2CP1070</a>	\$523.27	\$497.11	\$470.94	\$450.01	22
	30			<a href="#">PE2CP1074</a>	\$523.27	\$497.11	\$470.94	\$450.01	23

### N Connectors



Frequency Range (MHz.)	Coupling (dB)	Maximum Power	Directivity (dB)	Model No	1 Pc. Price	See Web for Volume Pricing			ROW
500-2,000	30	600 Watt	18	<a href="#">PE2240-30</a>	\$1,166.67	See Web for Volume Pricing			24
698-2,700	6	200 Watt	20	<a href="#">PE2CP1057</a>	\$469.14				25
	10			<a href="#">PE2CP1061</a>	\$521.29				26
	15			<a href="#">PE2CP1065</a>	\$521.29				27
	20			<a href="#">PE2CP1069</a>	\$540.28				28
	30			<a href="#">PE2CP1073</a>	\$540.28				29
800-2,500	6	60 Watt	20	<a href="#">PE2CP1023-6</a>	\$507.76				30
	10			<a href="#">PE2CP1023-10</a>	\$509.26				
	20			<a href="#">PE2CP1023-20</a>	\$508.84				
1,000-2,000	30	600 Watt	28	<a href="#">PE2226-30</a>	\$1,260.24				31
				<a href="#">PE2228A-30</a>	\$1,759.02				32
				<a href="#">PE2239-30</a>	\$1,898.35				33
				<a href="#">PE2236-35</a>	\$2,537.44	34			
				<a href="#">PE2227-30</a>	\$1,470.65	35			
				<a href="#">PE2230-30</a>	\$1,305.46	36			
				<a href="#">PE2235-30</a>	\$1,627.26	37			
5,000-11,000	30		15	<a href="#">PE2234-30</a>	\$1,031.46	38			

### SMA Connectors



Frequency Range (MHz.)	Coupling (dB)	Maximum Power	Directivity (dB)	Model No	1 Pc. Price	See Web for Volume Pricing			ROW	
500-1,000	10		25	<a href="#">PE2200-10</a>	\$396.54	See Web for Volume Pricing			39	
	20			<a href="#">PE2200-20</a>	\$441.11				40	
	30			<a href="#">PE2200-30</a>	\$443.91				41	
500-2,000	6	50 Watt	20	<a href="#">PE2CP003-6</a>	\$396.33				42	
				<a href="#">PE2208-6</a>	\$505.13				43	
				<a href="#">PE2CP003-10</a>	\$274.55				44	
	10			<a href="#">PE2208-10</a>	\$519.71				45	
				20	<a href="#">PE2CP003-20</a>				\$291.49	46
				23	<a href="#">PE2208-20</a>				\$534.69	47
500-3,000	20	30	18	<a href="#">PE2242-10</a>	\$279.00				48	
				<a href="#">PE2242-20</a>	\$279.00				49	
				<a href="#">PE2242A-20</a>	\$279.00				50	
				<a href="#">PE2242A-30</a>	\$269.97	51				
500-18,000	10	30 Watt	18	<a href="#">PE2243-10</a>	\$1,426.60	52				
				<a href="#">PE2243-16</a>	\$1,405.51	53				
				<a href="#">PE2243-20</a>	\$1,483.00	54				
				<a href="#">PE2243-30</a>	\$1,426.60	55				
600-4,000	10		18	<a href="#">PE2213-10</a>	\$747.00					
700-2,700	6	50 Watt	20	<a href="#">PE2CP002-6</a>	\$259.16					
	10			<a href="#">PE2CP002-10</a>	\$259.16					
	20			<a href="#">PE2CP002-20</a>	\$269.35					
800-2,200	10			<a href="#">PE2CP025-10</a>	\$216.31					
800-2,500	6			<a href="#">PE2CP1024-6</a>	\$496.93					
	10			<a href="#">PE2CP1025-10</a>	\$521.29					

Couplers & Hybrids

## Single Directional SMA Connectors



**Couplers &  
Hybrids**

Frequency Range (MHz.)	Coupling (dB)	Maximum Power	Directivity (dB)	Model No	1 Pc. Price	See Web for Volume Pricing	ROW	
800-2,500	20	50 Watt	20	<a href="#">PE2CP1025-20</a>	\$465.53	See Web for Volume Pricing	55	
	30			<a href="#">PE2CP1024-30</a>	\$509.26		56	
1,000-2,000	10		<a href="#">PE2201-10</a>	\$364.01	57			
	20		<a href="#">PE2CP1108</a>	\$173.17	58			
1,000-4,000	30		<a href="#">PE2201-30</a>	\$369.88	59			
	6		20	<a href="#">PE2CP005-6</a>	\$215.45		60	
			23	<a href="#">PE2209-6</a>	\$516.82		61	
	10		20	<a href="#">PE2CP005-10</a>	\$208.19		62	
			20	<a href="#">PE2CP1102</a>	\$159.31		63	
	2,000-4,000		20	<a href="#">PE2CP005-20</a>	\$221.08		64	
6			23	<a href="#">PE2209-20</a>	\$554.89		65	
			22	<a href="#">PE2202-6</a>	\$363.65		66	
20	<a href="#">PE2202-20</a>		\$375.25					
30	<a href="#">PE2202-30</a>		\$381.70					
2,000-8,000	6		50 Watt	20	<a href="#">PE2CP004-6</a>		\$283.95	67
					<a href="#">PE2210-6</a>		\$492.03	68
	10				<a href="#">PE2CP004-10</a>		\$300.80	69
					<a href="#">PE2210-10</a>		\$494.47	70
	20	<a href="#">PE2CP004-20</a>			\$295.02	71		
		<a href="#">PE2210-20</a>			\$507.95	72		
2,000-18,000	6	4 Watt	12	<a href="#">PE2215-6</a>	\$1,799.00	73		
	10	50 Watt		<a href="#">PE2CP000-10</a>	\$618.32	74		
		25 Watt		<a href="#">PE2CP1103</a>	\$443.31	75		
	20	50 Watt		<a href="#">PE2215-10</a>	\$2,029.30	76		
2,000-18,400	30	25 Watt	10	<a href="#">PE2CP000-20</a>	\$651.82	77		
	<a href="#">PE2CP000-30</a>			\$633.54	78			
2,600-5,200	20	50 Watt	20	<a href="#">PE2215-20</a>	\$1,734.07	79		
	10			<a href="#">PE2203-10</a>	\$522.25	80		
				<a href="#">PE2CP1109</a>	\$180.09	81		
	20			<a href="#">PE2203-20</a>	\$533.01			
4,000-8,000	30		<a href="#">PE2203-30</a>	\$546.71	82			
	6		<a href="#">PE2204-6</a>	\$374.36				
			10	<a href="#">PE2204-10</a>		\$370.69		
	20		<a href="#">PE2204-20</a>	\$375.35				
			<a href="#">PE2204-30</a>	\$409.93				
	4,000-12,400		6	17		<a href="#">PE2211-6</a>	\$540.28	83
10			<a href="#">PE2211-10</a>		\$494.29			
20			<a href="#">PE2211-20</a>		\$521.06			
4,000-18,000	6	12	<a href="#">PE2CP1100</a>	\$380.97	84			
	10		<a href="#">PE2CP1104</a>	\$380.97	85			
	20		<a href="#">PE2CP1110</a>	\$380.97	86			
6,000-18,000	10	10	<a href="#">PE2CP001-10</a>	\$478.94	87			
	20	12	<a href="#">PE2CP001-20</a>	\$478.94				
6,000-26,500	30	30 Watt	13	<a href="#">PE2CP1120-30</a>	\$999.00	88		
6,000-26,600	20			<a href="#">PE2CP1120-20</a>	\$1,037.96			
7,000-12,400	6	50 Watt	17	<a href="#">PE2CP1101</a>	\$304.77	89		
	10			<a href="#">PE2CP1105</a>	\$304.77	90		
	20			<a href="#">PE2205-20</a>	\$489.88	91		
				<a href="#">PE2205-30</a>	\$489.00			
7,000-16,000	30	12	<a href="#">PE2CP1112</a>	\$342.87	92			
7,000-18,000	10	15	<a href="#">PE2CP1106</a>	\$311.70	93			
			<a href="#">PE2212-10</a>	\$644.18	94			
7,500-16,000	6	12	<a href="#">PE2206-6</a>	\$471.02	95			
	10		<a href="#">PE2CP1107</a>	\$293.33				
12,400-18,000	6	4 Watt	15	<a href="#">PE2207-6</a>	\$557.35	96		
	10	50 Watt		<a href="#">PE2207-10</a>	\$482.40	97		
	20			<a href="#">PE2CP1111</a>	\$339.41	98		
				<a href="#">PE2207-20</a>	\$476.90	99		
	30			<a href="#">PE2207-30</a>	\$498.72			

## Dual Directional

### N Connectors



Frequency Range (MHz.)	Coupling (dB)	Maximum Power	Directivity (dB)	Model No	1	2-4	5-9	10+	ROW
2-30	50	2500 Watt	22	<a href="#">PE2CP1000</a>	\$3,009.65	\$2,889.26	\$2,768.88	\$2,648.49	1
20-500		500 Watt		<a href="#">PE2CP1002</a>	\$1,752.16	\$1,682.07	\$1,611.99	\$1,541.90	2
20-1,000		1000 Watt		<a href="#">PE2CP1003</a>	\$2,341.43	\$2,247.77	\$2,154.12	\$2,060.46	3
80-1,000	50	500 Watt	20	<a href="#">PE2CP1005</a>	\$1,740.27	\$1,670.66	\$1,601.05	\$1,531.44	4
		1000 Watt		<a href="#">PE2CP1007</a>	\$1,704.76	\$1,636.57	\$1,568.38	\$1,500.19	5
100-500	40	200 Watt	20	<a href="#">PE2CP1008</a>	\$2,430.78	\$2,333.55	\$2,236.32	\$2,139.09	6
		500 Watt		<a href="#">PE2CP1021</a>	\$1,424.73	\$1,367.74	\$1,310.75	\$1,253.76	7
		1000 Watt		<a href="#">PE2CP1010</a>	\$1,598.24	\$1,534.31	\$1,470.38	\$1,406.45	8
500-2,500	40	200 Watt	18	<a href="#">PE2CP1020</a>	\$2,278.86	\$2,187.71	\$2,096.55	\$2,005.40	9
		500 Watt		<a href="#">PE2CP1011</a>	\$1,102.16	\$1,058.07	\$1,013.99	\$969.90	10
500-3,000	40	200 Watt	18	<a href="#">PE2CP1012</a>	\$1,649.86	\$1,583.87	\$1,517.87	\$1,451.88	11
800-2,500				<a href="#">PE2CP1013</a>	\$1,775.83	\$1,704.80	\$1,633.76	\$1,562.73	12
800-4,200	20	500 Watt	20	<a href="#">PE2CP1015</a>	\$1,709.49	\$1,641.11	\$1,572.73	\$1,504.35	13
2,000-6,000				200 Watt	<a href="#">PE2CP1016</a>	\$2,035.23	\$1,953.82	\$1,872.41	\$1,791.00
			15	<a href="#">PE2CP1019</a>	\$1,435.34	\$1,377.93	\$1,320.51	\$1,263.10	15

### SC Connectors



Frequency Range (MHz.)	Coupling (dB)	Maximum Power	Directivity (dB)	Model No	1	2-4	5-9	10+	ROW
20-1,000	50	1000 Watt	20	<a href="#">PE2CP1006</a>	\$2,708.65	\$2,600.30	\$2,491.96	\$2,383.61	16
800-4,200	40	600 Watt	18	<a href="#">PE2CP1017</a>	\$2,785.27	\$2,673.86	\$2,562.45	\$2,451.04	17

### SMA Connectors



Frequency Range (MHz.)	Coupling (dB)	Maximum Power	Directivity (dB)	Model No	1 Pc. Price	See Web for Volume Pricing			ROW
20-520	50	200 Watt	20	<a href="#">PE2CP1001</a>	\$1,120.55	See Web for Volume Pricing			18
20-1,000				<a href="#">PE2CP1004</a>	\$1,405.85				19
100-500				<a href="#">PE2CP1009</a>	\$1,286.62				20
500-1,000	10	50 Watt	22	<a href="#">PE2217-10</a>	\$753.26				21
	20			<a href="#">PE2217-20</a>	\$765.40				
	30			<a href="#">PE2217-30</a>	\$735.95				
800-2,500	40	200 Watt	20	<a href="#">PE2CP1014</a>	\$1,069.49				22
	10			<a href="#">PE2218-10</a>	\$735.95				
	20			<a href="#">PE2218-20</a>	\$735.95				
1,000-2,000	30	50 Watt	22	<a href="#">PE2218-30</a>	\$745.94				23
	10			<a href="#">PE2219-10</a>	Call				
	20			<a href="#">PE2219-20</a>	\$847.59				
2,000-4,000	20	50 Watt	20	<a href="#">PE2CP1018</a>	\$1,058.65				24
100 Watt		<a href="#">PE2CP1018</a>		\$1,058.65	25				
2,000-6,000	20	50 Watt	20	<a href="#">PE2CP1113</a>	\$616.47				26
2,000-8,000				<a href="#">PE2220-10</a>	\$771.83				
2,600-5,200	10	10 Watt	18	<a href="#">PE2220-20</a>	\$681.08				27
	20			<a href="#">PE2220-30</a>	\$693.91				
	30			<a href="#">PE2221-10</a>	\$749.83				
4,000-8,000	10	10 Watt	16	<a href="#">PE2222-30</a>	\$735.95				28
7,000-12,400	30			<a href="#">PE2223-10</a>	\$735.95				29
8,000-16,000	10	50 Watt	15	<a href="#">PE2223-20</a>	\$765.40				30
	20			<a href="#">PE2223-30</a>	\$764.53				
	30			<a href="#">PE2224-20</a>	\$758.69				
12,400-18,000	20	50 Watt	15	<a href="#">PE2224-30</a>	\$811.57				31
	30								



## 90 Degree Hybrids

### 2.92mm Connectors



Frequency Range (MHz.)	Coupling (dB)	Maximum Power	Minimum Isolation (dB)	Model No	1-4	5-9	10-24	25+	ROW
2,000-40,000	3	20 Watt	10	<a href="#">PE2CP1150</a>	\$1,875.00	\$1,781.25	\$1,687.50	\$1,612.50	32
5,000-26,500			14	<a href="#">PE2CP1147</a>	\$937.50	\$890.63	\$843.75	\$806.25	33
8,000-43,500			12	<a href="#">PE2CP1149</a>	\$1,406.25	\$1,335.94	\$1,265.63	\$1,209.38	34
10,000-26,500			15	<a href="#">PE2CP1146</a>	\$937.50	\$890.63	\$843.75	\$806.25	35
20,000-40,000			12	<a href="#">PE2CP1148</a>	\$1,406.25	\$1,335.94	\$1,265.63	\$1,209.38	36

### Pin Connectors

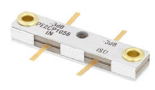

Frequency Range (MHz.)	Coupling (dB)	Maximum Power	Minimum Isolation (dB)	Model No	1 Pc. Price	See Web for Volume Pricing	ROW
20-1,000		50 Watt	16	<a href="#">PE2CP1026</a>	\$807.84	See Web for Volume Pricing	37
		150 Watt		<a href="#">PE2CP1027</a>	\$914.41		38
80-1,000		250 Watt	20	<a href="#">PE2CP1028</a>	\$641.79		39
		150 Watt		<a href="#">PE2CP1029</a>	\$300.03		40
100-500		200 Watt	18	<a href="#">PE2CP1032</a>	\$92.01		41
		800 Watt		<a href="#">PE2CP1033</a>	\$395.33		42
225-400		250 Watt	20	<a href="#">PE2CP1034</a>	\$109.30		43
		400 Watt		<a href="#">PE2CP1035</a>	\$152.41		44
225-450		800 Watt	19	<a href="#">PE2CP1036</a>	\$395.33		45
		200 Watt		<a href="#">PE2CP1037</a>	\$81.39		46
400-1,000		400 Watt	20	<a href="#">PE2CP1038</a>	\$117.71		47
		800 Watt		<a href="#">PE2CP1039</a>	\$460.43		48
500-2,500		150 Watt	18	<a href="#">PE2CP1040</a>	\$184.87		49
		200 Watt		<a href="#">PE2CP1041</a>	\$281.34		50
500-3,000		300 Watt	17	<a href="#">PE2CP1042</a>	\$400.50		51
		125 Watt		<a href="#">PE2CP1043</a>	\$184.87		52
800-1,600		200 Watt	17	<a href="#">PE2CP1044</a>	\$335.89		53
				20	<a href="#">PE2CP1045</a>		\$90.63
800-2,500		400 Watt	18		<a href="#">PE2CP1046</a>		\$144.44
				17	<a href="#">PE2CP1047</a>		\$678.65
800-2,700		125 Watt	20		<a href="#">PE2CP1048</a>	\$81.39	57
				200 Watt	<a href="#">PE2CP1049</a>	\$81.39	58
960-1,220		400 Watt	18		<a href="#">PE2CP1050</a>	\$108.46	59
				1000 Watt	<a href="#">PE2CP1051</a>	\$460.43	60
1,000-2,000		150 Watt	18		<a href="#">PE2CP1052</a>	\$95.35	61
				450 Watt	<a href="#">PE2CP1053</a>	\$174.41	62
1,000-3,000		80 Watt	16		<a href="#">PE2CP1054</a>	\$159.07	63
				18	<a href="#">PE2CP1055</a>	\$81.39	64
1,000-4,200		100 Watt	18		<a href="#">PE2CP1056</a>	\$85.54	65

### SMA Connectors



Frequency Range (MHz.)	Coupling (dB)	Maximum Power	Minimum Isolation (dB)	Model No	1 Pc. Price	See Web for Volume Pricing	ROW
500-1,000	3	50 Watt	22	<a href="#">PE2CP011</a>	\$248.00	See Web for Volume Pricing	66
		100 Watt	28	<a href="#">PE2CP1140</a>	\$468.75		67
800-3,000		50 Watt	20	<a href="#">PE2050</a>	\$522.91		68
		22	<a href="#">PE2CP021</a>	\$367.80	69		
1,000-2,000		100 Watt	22	<a href="#">PE2CP013</a>	\$248.00		70
			28	<a href="#">PE2051</a>	\$462.87		71
1,000-18,000	3	50 Watt	15	<a href="#">PE2CP1144</a>	\$596.88		72
			23	<a href="#">PE2CP1145</a>	\$521.88		73
2,000-4,000		30 Watt	22	<a href="#">PE2CP017</a>	\$248.00		74
			22	<a href="#">PE2052</a>	\$453.53		75
2,000-8,000		50 Watt	17	<a href="#">PE2058</a>	\$515.30		76
			15	<a href="#">PE2CP023</a>	\$1,014.03		77
2,000-18,000		50 Watt	18	<a href="#">PE2CP019</a>	\$248.00		78

Couplers & Hybrids

### SMA Connectors



Frequency Range (MHz.)	Coupling (dB)	Maximum Power	Minimum Isolation (dB)	Model No	1 Pc. Price	See Web for Volume Pricing			ROW
4,000-12,400	4	100 Watt		<a href="#">PE2059</a>	\$782.12				79
4,000-18,000	3	50 Watt	16	<a href="#">PE2CP1143</a>	\$521.88	See Web for Volume Pricing			80
5,000-10,000			20	<a href="#">PE2CP1141</a>	\$468.75				81
6,000-18,000		30 Watt	16	<a href="#">PE2CP1142</a>	\$550.00				82
6,000-12,400		100 Watt	17	<a href="#">PE2055</a>	\$569.65				83
7,000-18,000		30 Watt	18	<a href="#">PE2CP1022</a>	\$664.74				84
7,500-16,000		100 Watt		<a href="#">PE2056A</a>	\$553.80				85
12,000-18,000	40 Watt	15	<a href="#">PE2057</a>	\$500.00				86	

### 180 Degree Hybrids

#### 2.92mm Connectors



Frequency Range (MHz.)	Coupling (dB)	Maximum Power	Minimum Isolation (dB)	Model No	1-4	5-9	10-24	25+	ROW
26,500-40,000	3	20 Watt	15	<a href="#">PE2CP1161</a>	\$1,956.25	\$1,858.44	\$1,760.63	\$1,682.38	87

### SMA Connectors



Frequency Range (MHz.)	Coupling (dB)	Maximum Power	Minimum Isolation (dB)	Model No	1-4	5-9	10-24	25+	ROW
500-1,000	3	50 Watt	22	<a href="#">PE2CP1151</a>	\$646.88	\$614.53	\$582.19	\$556.31	88
1,000-2,000				<a href="#">PE2CP1152</a>	\$646.88	\$614.53	\$582.19	\$556.31	89
1,300-2,600		100 Watt	20	<a href="#">PE2CP1153</a>	\$646.88	\$614.53	\$582.19	\$556.31	90
1,400-6,000		30 Watt	22	<a href="#">PE2CP1154</a>	\$1,262.50	\$1,199.38	\$1,136.25	\$1,085.75	91
2,000-4,000		50 Watt	20	<a href="#">PE2CP1155</a>	\$646.88	\$614.53	\$582.19	\$556.31	92
2,000-8,000				<a href="#">PE2CP1157</a>	\$843.75	\$801.56	\$759.38	\$725.63	93
2,000-18,000		50 Watt	16	<a href="#">PE2CP1158</a>	\$1,312.50	\$1,246.88	\$1,181.25	\$1,128.75	94
4,000-8,000		80 Watt	18	<a href="#">PE2CP1159</a>	\$718.75	\$682.81	\$646.88	\$618.13	95
4,000-18,000		50 Watt		<a href="#">PE2CP1160</a>	\$978.13	\$929.22	\$880.31	\$841.19	96

## RF DIPLEXERS

75 Ohm Diplexer F Female with 5 MHz to 390 MHz Low Pass and 650 MHz to 1,000 MHz High Pass [PE8DP1001](#)

- 5 - 1000 MHz
- 75 Ohms Impedance
- Typical Return loss 18 dB
- Bidirectional design
- EN 50083-2 Class A Standard

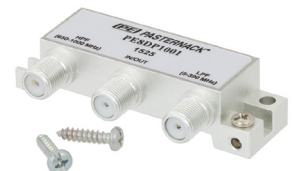

In-stock and available to ship today!



Technical Support  
+1 (949) 261-1920



Same-Day Shipping,  
Even Custom  
Cable Assemblies

## FILTERS

**NEW**

Low Pass Harmonic Filters: [PEHFL0000](#) - [PEHFL0001](#)

- Passband frequency: DC - 6000Hz
- 50 Ohms impedance
- Broadband design: C, L & S Band
- RF input power passband: 50 W
- VSWR: 1.5:1



**In-stock and available to ship today!**

### SMA Connectors

#### Bandpass Filters



Bandpass Frequency (MHz)	Rejection (MHz)	Max. Insertion Loss (dB)	Model No	1 Pc. Price	See Web for Volume Pricing	ROW
824 - 849	50 dB at 736.5 50 dB at 936.5	2	<a href="#">PE8705</a>	\$474.42	See Web for Volume Pricing	6
869 - 894	50 dB at 781.5 50 dB at 981.5		<a href="#">PE8706</a>	\$488.10		7
902 - 928	50 dB at 815 50 dB at 1,015		<a href="#">PE8700</a>	\$492.92		8
1,000 - 2,000	55 dB at 650 55 dB at 3,000	1	<a href="#">PE87FL1012</a>	\$423.68		9
1,217 - 1,237	50 dB at 1,127 50 dB at 1,327		<a href="#">PE8704</a>	\$449.00		10
1,565 - 1,585	50 dB at 1,475 50 dB at 1,675	2	<a href="#">PE8703</a>	\$492.92		11
1,710 - 1,770	50 dB at 1,490 50 dB at 1,990		<a href="#">PE8710</a>	\$488.10		12
1,850 - 1,910	50 dB at 1,630 50 dB at 2,130		<a href="#">PE8707</a>	\$493.40		13
1,920 - 1,980	50 dB at 1,700 50 dB at 2,200	1	<a href="#">PE8709</a>	\$518.46		14
1,930 - 1,990	50 dB at 1,710 50 dB at 2,210		<a href="#">PE8708</a>	\$585.72		15
2,000 - 4,000	55 dB at 1,300 55 dB at 6,000	1	<a href="#">PE87FL1013</a>	\$440.20		16
2,110 - 2,170	50 dB at 1,890 50 dB at 2,390		<a href="#">PE8711</a>	\$726.32		17
2,400 - 2,500	50 dB at 2,050 50 dB at 2,850		<a href="#">PE8701</a>	\$491.93		18
2,500 - 2,700	50 dB at 1,700 50 dB at 3,500	1	<a href="#">PE8712</a>	\$562.80		19
3,300 - 3,700	50 dB at 1,600 50 dB at 5,400		<a href="#">PE8713</a>	\$517.29		20
4,400 - 4,950	30 dB at 5,250 30 dB at 5,850	1	<a href="#">PE8739</a>	\$364.70		21
4,900 - 5,900	50 dB at 400 50 dB at 10,400		<a href="#">PE8714</a>	\$465.29		22
5,250 - 5,850	30 dB at 4,400 30 dB at 4,950	1	<a href="#">PE8740</a>	\$367.45		23
5,725 - 5,875	50 dB at 5,200 50 dB at 6,400		<a href="#">PE8702</a>	\$478.70		24
7,250 - 7,750	30 dB at 7,900 30 dB at 8,400	2	<a href="#">PE8741</a>	\$391.55		25
7,900 - 8,400	30 dB at 7,250 30 dB at 7,750		<a href="#">PE8742</a>	\$391.55		26
9,900 - 10,800	50 dB at 8,350 50 dB at 12,350	1	<a href="#">PE87FL1000</a>	\$500.41		27
10,550 - 11,800	50 dB at 8,425 50 dB at 13,925		<a href="#">PE87FL1001</a>	\$500.41		28
10,700 - 12,200	50 dB at 8,450 50 dB at 14,450		<a href="#">PE87FL1003</a>	\$500.41		29
11,700 - 12,800	50 dB at 9,750 50 dB at 14,750		<a href="#">PE87FL1002</a>	\$500.41		30



### SMA Connectors

#### Bandpass Filters



Bandpass Frequency (MHz)	Rejection (MHz)	Max. Insertion Loss (dB)	Model No	1 Pc. Price	See Web for Volume Pricing			ROW
12,200 - 12,700	50 dB at 11,450 50 dB at 13,450	2	<a href="#">PE87FL1004</a>	\$500.41	See Web for Volume Pricing			31
14,000 - 14,800	50 dB at 12,850 50 dB at 15,950		<a href="#">PE87FL1005</a>	\$467.67				32
17,200 - 18,200	35 dB at 16,200 35 dB at 19,200	1	<a href="#">PE87FL1008</a>	\$467.67				33
17,200 - 21,200	50 dB at 13,450 50 dB at 24,950		<a href="#">PE87FL1007</a>	\$450.12				34
17,300 - 18,100	50 dB at 16,200 50 dB at 19,200	2	<a href="#">PE87FL1006</a>	\$500.41				35
17,700 - 21,200	50 dB at 16,000 50 dB at 24,000		<a href="#">PE8743</a>	\$427.01				36
18,200 - 19,200	35 dB at 17,200 35 dB at 20,200	2	<a href="#">PE87FL1009</a>	\$467.67				37
19,200 - 20,200	35 dB at 18,200 35 dB at 21,200		<a href="#">PE87FL1010</a>	\$467.67				38
20,200 - 21,200	35 dB at 19,200 35 dB at 22,200	3	<a href="#">PE87FL1011</a>	\$450.12				39
27,500 - 31,000	50 dB at 25,000 50 dB at 32,750		<a href="#">PE8747</a>	\$431.97				40

#### Highpass Filters



Bandpass Frequency (MHz)	Rejection (MHz)	Max. Insertion Loss (dB)	Model No	1 Pc. Price	See Web for Volume Pricing			ROW
100 - 300	60 dB at 15	1	<a href="#">PE8717</a>	\$382.85	See Web for Volume Pricing			41
100 - 750	60 dB at 50		<a href="#">PE8716</a>	\$610.58				42
100 - 2,500	60 dB at 500		<a href="#">PE8715</a>	\$382.85				43
300 - 1,000	60 dB at 150		<a href="#">PE8718</a>	\$364.99				44
1,000 - 13,000	40 dB at 0	2	<a href="#">PE87FL1018</a>	\$785.11				45
2,000 - 18,000			<a href="#">PE87FL1019</a>	\$770.01				46

#### Lowpass Filters



Bandpass Frequency (MHz)	Rejection (MHz)	Max. Insertion Loss (dB)	Model No	1 Pc. Price	See Web for Volume Pricing			ROW	
DC - 30	60 dB at 60	1	<a href="#">PE8723</a>	\$347.72	See Web for Volume Pricing			47	
DC - 100	60 dB at 200		<a href="#">PE8719</a>	\$341.35				48	
DC - 225	60 dB at 450		<a href="#">PE8722</a>	\$328.54				49	
DC - 300	60 dB at 600		<a href="#">PE8724</a>	\$548.25				50	
DC - 400	60 dB at 800		<a href="#">PE8726</a>	\$251.13				51	
DC - 700	60 dB at 1,400		<a href="#">PE8727</a>	\$363.63				52	
DC - 1,000	60 dB at 2,000		<a href="#">PE8720</a>	\$331.78				53	
DC - 2,000	60 dB at 4,000		<a href="#">PE8721</a>	\$331.78				54	
DC - 3,000	60 dB at 6,000		2	<a href="#">PE8725</a>				\$387.62	55
DC - 4,400	50 dB at 12,000			<a href="#">PE87FL1014</a>				\$440.20	56
DC - 7,000	50 dB at 15,000	<a href="#">PE87FL1015</a>		\$440.20	57				
DC - 9,500	50 dB at 18,000	<a href="#">PE87FL1016</a>		\$440.20	58				
DC - 11,000		<a href="#">PE87FL1017</a>	\$440.20	59					

## N Connectors

### Band Pass



Bandpass Frequency (MHz)	Rejection (MHz)	Max. Insertion Loss (dB)	Model No	Price				ROW
				1	2-4	5-9	10+	
125 - 250			<a href="#">PE8728</a>	\$2,234.57	\$2,156.36	\$2,078.15	\$2,011.11	60
250 - 500			<a href="#">PE8729</a>	\$2,279.90	\$2,200.10	\$2,120.31	\$2,051.91	61
500 - 1 GHz			<a href="#">PE8730</a>	\$2,437.90	\$2,352.57	\$2,267.25	\$2,194.11	62
750 - 1.5 GHz			<a href="#">PE8731</a>	\$2,414.53	\$2,330.02	\$2,245.51	\$2,173.08	63
1 GHz - 2 GHz			<a href="#">PE8732</a>	\$2,193.06	\$2,116.30	\$2,039.55	\$1,973.75	64
1.5 GHz - 3 GHz			<a href="#">PE8733</a>	\$2,421.28	\$2,336.54	\$2,251.79	\$2,179.15	65

### Band Reject



Bandpass Frequency (MHz)	Rejection (MHz)	Max. Insertion Loss (dB)	Model No	Price				ROW
				1	2-4	5-9	10+	
100 - 200			<a href="#">PE8734</a>	\$2,478.62	\$2,391.87	\$2,305.12	\$2,230.76	66
200 - 400			<a href="#">PE8735</a>	\$2,235.68	\$2,157.43	\$2,079.18	\$2,012.11	67
250 - 500			<a href="#">PE8736</a>	\$2,643.87	\$2,551.33	\$2,458.80	\$2,379.48	68
1 GHz - 2 GHz			<a href="#">PE8738</a>	\$2,390.09	\$2,306.44	\$2,222.78	\$2,151.08	69

## FREQUENCY DIVIDERS



Input Frequency (GHz)	Divide-By Prescaler	CW Input Power (CW) (dBm)	Typ Power Out (dBm)	Phase Noise @100 kHz (dBc/Hz)	DC Bias (Volts/mA)	Model No	Price				ROW
							1	2-4	5-9	10+	
0.1 - 7	3	-12	-1	-150	+12 / 70	<a href="#">PE88D3000</a>	\$942.03	\$885.51	\$838.41	\$800.73	70
	5					<a href="#">PE88D25000</a>	\$906.67	\$852.27	\$806.94	\$770.67	71
	15					<a href="#">PE88D15000</a>	\$1,000.00	\$940.00	\$890.00	\$850.00	72
0.1 - 12	8		-6	-153	+12 / 70	<a href="#">PE88D8003</a>	\$1,003.33	\$943.13	\$892.96	\$852.83	73
	24					<a href="#">PE88D24000</a>	\$1,160.00	\$1,090.40	\$1,032.40	\$986.00	74
	40					<a href="#">PE88D40000</a>	\$1,160.00	\$1,090.40	\$1,032.40	\$986.00	75
0.1 - 12.5	10			-144	+12 / 185	<a href="#">PE88D1001</a>	\$1,205.24	\$1,132.93	\$1,072.66	\$1,024.45	76
0.1 - 13	4		5	-151	+12 / 120	<a href="#">PE88D4003</a>	\$1,073.63	\$1,009.21	\$955.53	\$912.59	77
	12					<a href="#">PE88D12000</a>	\$1,160.00	\$1,090.40	\$1,032.40	\$986.00	78
	20					<a href="#">PE88D20000</a>	\$1,160.00	\$1,090.40	\$1,032.40	\$986.00	79
0.1 - 15	5		5	-153	+5 / 205	<a href="#">PE88D5001</a>	\$1,503.33	\$1,413.13	\$1,337.96	\$1,277.83	80
	6					<a href="#">PE88D6000</a>	\$1,503.33	\$1,413.13	\$1,337.96	\$1,277.83	81
	7					<a href="#">PE88D7000</a>	\$1,503.33	\$1,413.13	\$1,337.96	\$1,277.83	82
	9					<a href="#">PE88D9000</a>	\$1,503.33	\$1,413.13	\$1,337.96	\$1,277.83	83
0.1 - 20	2				+5 / 160	<a href="#">PE88D2002</a>	\$1,561.96	\$1,468.24	\$1,390.14	\$1,327.67	84
	4					<a href="#">PE88D4002</a>	\$1,503.33	\$1,413.13	\$1,337.96	\$1,277.83	85
	8					<a href="#">PE88D8002</a>	\$1,503.33	\$1,413.13	\$1,337.96	\$1,277.83	86
0.2 - 6	10		-2		+12 / 100	<a href="#">PE88D1002</a>	\$813.33	\$764.53	\$723.86	\$691.33	87
	20					<a href="#">PE88D20001</a>	\$813.33	\$764.53	\$723.86	\$691.33	88
0.4 - 4	16		-1		+12 / 75	<a href="#">PE88D16000</a>	\$720.00	\$676.80	\$640.80	\$612.00	89
	32					<a href="#">PE88D32000</a>	\$720.00	\$676.80	\$640.80	\$612.00	90
0.5 - 8	5	-20	-1		+5 / 80	<a href="#">PE88D5000</a>	\$2,751.07	\$2,641.03	\$2,530.98	\$2,420.94	91
0.5 - 18	2	-15	-4	-147	+12 / 85	<a href="#">PE88D2001</a>	\$1,376.67	\$1,294.07	\$1,225.24	\$1,170.17	92
	4	-20				<a href="#">PE88D4000</a>	\$3,864.98	\$3,710.38	\$3,555.78	\$3,401.18	93
	8	-15				<a href="#">PE88D4001</a>	\$1,376.67	\$1,294.07	\$1,225.24	\$1,170.17	94
		<a href="#">PE88D8001</a>				\$1,430.36	\$1,344.54	\$1,273.02	\$1,215.81	95	
10	-20	-1		+5 / 152	<a href="#">PE88D1000</a>	\$4,220.73	\$3,967.49	\$3,756.45	\$3,587.62	96	

# MIXERS

## Double Balanced



RF Range (GHz)	LO Range (GHz)	IF Range (GHz)	LO Power (dBm)	Conv. Loss (dB)	Connector	Model No	1 Pc. Price	See Web for Volume Pricing			ROW
0.5 MHz- 500 MHz	0.5 MHz- 500 MHz	DC - 500 MHz	10	6.8	SMA	<a href="#">PE86X1013</a>	\$322.84	See Web for Volume Pricing			1
1 MHz- 2.7	1 MHz- 2.7	1 MHz - 2	10	7	SMA	<a href="#">PE86X1020</a>	\$411.89				2
1 MHz- 2.7			17			<a href="#">PE86X1021</a>	\$504.66				3
5 MHz- 1	5 MHz- 1	DC - 1	7	7	SMA	<a href="#">PE86X1014</a>	\$322.84				4
5 MHz- 1			13			<a href="#">PE86X1016</a>	\$310.72				5
5 MHz- 1.5	5 MHz- 1.5	DC - 1	7	7.5	SMA	<a href="#">PE86X1018</a>	\$322.84				6
5 MHz- 3.5	5 MHz- 3.5	5 MHz - 2.5	13	8	SMA	<a href="#">PE86X1022</a>	\$378.58				7
5 MHz- 4.2	5 MHz- 4.2	5 MHz - 3.5	13	9.8	SMA	<a href="#">PE86X1023</a>	\$411.89				8
10 MHz- 1	10 MHz- 1	DC - 800 MHz	4	7.2	SMA	<a href="#">PE86X1015</a>	\$322.84				9
10 MHz- 1.2	10 MHz- 1.2	DC - 1.2	13	8	SMA	<a href="#">PE86X1017</a>	\$328.58				10
40 MHz- 2.5	40 MHz- 2.5	DC - 1	13	8	SMA	<a href="#">PE86X1019</a>	\$449.00				11
800 MHz- 4.2	800 MHz- 4.2	DC - 800 MHz	13	9	SMA	<a href="#">PE86X1024</a>	\$359.94				12
2 - 8	2 - 8	DC - 1.5	10	5.5	SMA	<a href="#">PE8650</a>	\$701.00				13
2 - 18	2 - 18	DC - 600 MHz	10	6.5	SMA	<a href="#">PE8652</a>	\$908.92				14
2.25 - 18	2.25 - 18	DC - 3	13	11	SMA	<a href="#">PE86X1026</a>	\$1,150.33				15
2.5 - 6	2.5 - 6	DC - 1.5	17	8.7	SMA	<a href="#">PE86X1025</a>	\$467.55				16
3 - 10	3 - 10	DC - 4	17	9	SMA	<a href="#">PE86X1027</a>	\$1,150.33				17
5 - 18	5 - 18	DC - 4	10	6.2	SMA	<a href="#">PE8653</a>	\$999.43				18
5 - 20	5 - 20	DC - 3	20	10	SMA	<a href="#">PE86X1006</a>	\$1,424.08				19
5 - 20			10	<a href="#">PE86X1008</a>	\$1,420.59	20					
6 - 18	6 - 18	DC - 3	6	7.5	SMA	<a href="#">PE86X1007</a>	\$1,476.18				21
6 - 26	6 - 26	DC - 8	13	10	SMA	<a href="#">PE86X1028</a>	\$1,257.94				22
7 - 14	7 - 14	DC - 5	13		SMA	<a href="#">PE86X1003</a>	\$4,601.37				23
7 - 34	7 - 34	DC - 8	13	11	2.92mm	<a href="#">PE86X1029</a>	\$1,350.00				24
7 - 43	7 - 43	DC - 10	13	9	2.92mm	<a href="#">PE86X1009</a>	\$2,930.00				25
11 - 20	11 - 20	DC - 6	13		2.92mm	<a href="#">PE86X1004</a>	\$2,859.67				26
16 - 30	16 - 30	DC - 8	13	9	2.92mm	<a href="#">PE86X1030</a>	\$1,402.65				27
16 - 32	16 - 32	DC - 8	13		2.92mm	<a href="#">PE86X1000</a>	\$3,402.00				28
23 - 37	23 - 37	DC - 13	13	9	2.92mm	<a href="#">PE86X1002</a>	\$4,265.00				29
24 - 32	24 - 32	DC - 8	13	10.5	2.92mm	<a href="#">PE86X1031</a>	\$1,350.00				30
24 - 38	24 - 38	DC - 8	13	9	2.92mm	<a href="#">PE86X1001</a>	\$4,581.99				31
24 - 40	24 - 40	DC - 18	13	8	2.92mm	<a href="#">PE86X1010</a>	\$2,392.63	32			

## IQ



RF Range (GHz)	LO Range (GHz)	IF Range (GHz)	LO Power (dBm)	Conv. Loss (dB)	Connector	Model No	1	2-4	5-9	10+	ROW
4 - 8.5	4 - 8.5	DC - 3.5	15		SMA	<a href="#">PE86X9000</a>	\$3,114.79	\$3,005.77	\$2,896.75	\$2,803.31	33
6 - 10	6 - 10	DC - 3.5	19	7.5	SMA	<a href="#">PE86X9001</a>	\$3,114.79	\$2,990.20	\$2,865.61	\$2,741.02	34
8.5 - 13.5	8.5 - 13.5	DC - 2	19	8	SMA	<a href="#">PE86X9002</a>	\$3,419.09	\$3,282.33	\$3,145.56	\$3,008.80	35
11 - 16	11 - 16	DC - 3.5	19	9	SMA	<a href="#">PE86X9003</a>	\$3,737.05	\$3,587.57	\$3,438.09	\$3,288.60	36
15 - 23	15 - 23	DC - 3.5	17	8	SMA	<a href="#">PE86X9004</a>	\$4,051.61	\$3,889.55	\$3,727.48	\$3,565.42	37
20 - 31	20 - 31	DC - 4.5	17	10	2.92mm	<a href="#">PE86X9005</a>	\$5,147.79	\$4,941.88	\$4,735.97	\$4,530.06	38
30 - 38	30 - 38	DC - 3.5	17		2.92mm	<a href="#">PE86X9006</a>	\$5,179.26	\$4,972.09	\$4,764.92	\$4,557.75	39

## Triple Balanced



RF Range (GHz)	LO Range (GHz)	IF Range (GHz)	LO Power (dBm)	Conv. Loss (dB)	Connector	Model No	1-4	5-9	10-24	25+	ROW
6 - 18	6 - 18	1.5 - 8	10	7	SMA	<a href="#">PE8654</a>	\$999.43	\$949.46	\$899.49	\$859.51	40

See Our Website For Current Pricing & Real-Time Stock Availability!

Frequency Conversion Components



Technical Support  
+1 (949) 261-1920



Same-Day Shipping,  
Even Custom Cable Assemblies

## MODULATOR

### BiPhase



Freq. Band (GHz)	Insertion Loss (dB)	Switching Speed (nsec)	Phase State (On/Off)	VSWR	RF Input Power (CW) (dBm)	Max Peak RF Input Power (1usec)	RF Conn.	Model No	1	2-4	5-9	10+	ROW
0.5 MHz to 1	1.5	50	0°/180°	1.5:1	+20	0.5	SMA Female	<a href="#">PE86GM2000</a>	\$3,483.33	\$3,361.41	\$3,239.50	\$3,135.00	41
1 to 2	3	30						<a href="#">PE86GM2001</a>	\$3,716.67	\$3,586.59	\$3,456.50	\$3,345.00	42
2 to 4	2.5	75						<a href="#">PE86GM2002</a>	\$3,950.00	\$3,811.75	\$3,673.50	\$3,555.00	43
2 to 6	1.7	50						<a href="#">PE86GM2003</a>	\$4,183.33	\$4,036.91	\$3,890.50	\$3,765.00	44
4 to 8	2.5	30		2.0:1	+20			<a href="#">PE86GM2004</a>	\$4,416.67	\$4,262.09	\$4,107.50	\$3,975.00	45
6 to 12		15						<a href="#">PE86GM2005</a>	\$4,650.00	\$4,487.25	\$4,324.50	\$4,185.00	46
8 to 18	3	75		1.9:1	<a href="#">PE86GM2006</a>			\$4,883.33	\$4,712.41	\$4,541.50	\$4,395.00	47	
2 to 18	3.5	35			<a href="#">PE86GM2007</a>			\$5,816.67	\$5,613.09	\$5,409.50	\$5,235.00	48	
26.5 to 40	5.5	50		2.0:1	<a href="#">PE86GM2008</a>		\$6,983.33	\$6,738.91	\$6,494.50	\$6,285.00	49		

## FREQUENCY MULTIPLIERS

### Active



Input Freq. (GHz)	Output Freq. (GHz)	Input Drive Power (dBm)	Out Pwr Typ (dBm)	Fund. Iso. Typ (dB)	3rd Harmonics (dBc)	CW Pwr In (dBm)	Female In/Out Conn.	Model No	1	2-4	5-9	10+	ROW
4 - 10.5	8 - 21	6	14				SMA	<a href="#">PE88X2003</a>	\$4,684.14	\$4,496.77	\$4,309.41	\$4,122.04	50
9 - 14.5	18 - 29		16				2.92mm	<a href="#">PE88X2000</a>	\$4,508.47	\$4,328.13	\$4,147.79	\$3,967.45	51
12 - 16.5	24 - 33		17				<a href="#">PE88X2001</a>	\$4,433.24	\$4,255.91	\$4,078.58	\$3,901.25	52	
16 - 23	32 - 46		13				<a href="#">PE88X2002</a>	\$4,946.53	\$4,748.67	\$4,550.81	\$4,352.95	53	

\*Field Replaceable Connectors

### Passive



Input Freq. (GHz)	Output Freq. (GHz)	Input Drive Power (dBm)	Out Pwr Typ (dBm)	Fund. Iso. Typ (dB)	3rd Harmonics (dBc)	CW Pwr In (dBm)	Female In/Out Conn.	Model No	1-4	5-9	10-24	25+	ROW
1.5 - 5	3 - 10			25		13	SMA	<a href="#">PE8600</a>	\$684.16	\$649.95	\$615.74	\$588.38	54
2 - 6	4 - 12							<a href="#">PE8601</a>	\$720.09	\$684.09	\$648.08	\$619.28	55
4 - 9	8 - 18							<a href="#">PE8602</a>	\$728.63	\$692.20	\$655.77	\$626.62	56
9 - 13	18 - 26							<a href="#">PE8603</a>	\$728.70	\$692.27	\$655.83	\$626.68	57

\*Field Replaceable Connectors

# LIMITERS

## High Rel



Frequency Range (GHz.)	Insertion Loss Max. (dB)	Input VSWR Typ.	Leakage Power Max. (dBm)	Recovery Time Typ. (ns)	Input Power (CW) Max. (W)	Peak Power Max. (W)	Limiting Threshold Typ. (dBm)	Model No	1	2-4	5-9	10+	ROW
20 MHz - 4	0.8	1.8:1	13	15,000	2	100	10	<a href="#">PE80L2003</a>	\$1,252.27	\$1,202.18	\$1,152.09	\$1,102.00	58
500 MHz - 18	1.5	1.5:1	10	10	1		14	<a href="#">PE80L1000</a>	\$3,981.43	\$3,822.17	\$3,662.92	\$3,503.66	59
	2	1.8:1	18	15,000	5		<a href="#">PE80L2005</a>	\$1,739.45	\$1,669.87	\$1,600.29	\$1,530.72	60	
2 - 8	1	2:1	13	40	1	200	6	<a href="#">PE80L1001</a>	\$4,801.17	\$4,609.12	\$4,417.08	\$4,225.03	61
2 - 18	2	2:1	14	100			<a href="#">PE80L2001</a>	\$4,557.14	\$4,374.85	\$4,192.57	\$4,010.28	62	
		2:1		100			<a href="#">PE80L3000</a>	\$4,721.47	\$4,532.61	\$4,343.75	\$4,154.89	63	
6 - 18	2.5	2:1	15	15,000	5	<a href="#">PE80L2006</a>	\$1,465.17	\$1,406.56	\$1,347.96	\$1,289.35	64		
8 - 12	1.2	1.8:1	18	12	10	100	15	<a href="#">PE80L2000</a>	\$3,641.75	\$3,496.08	\$3,350.41	\$3,204.74	65
12 - 18	1.5	1.5:1	10	10	3		1	<a href="#">PE80L2004</a>	\$1,441.43	\$1,383.77	\$1,326.12	\$1,268.46	66
18 - 40	4	2.1:1	12	10	1		20	<a href="#">PE80L4000</a>	\$3,911.04	\$3,754.60	\$3,598.16	\$3,441.72	67
	4.5	3:1	13	15,000		5	<a href="#">PE80L2002</a>	\$5,047.83	\$4,845.92	\$4,644.00	\$4,442.09	68	
26.5 - 40	3	2:1	13	15,000	1	100	6	<a href="#">PE80L2007</a>	\$2,114.75	\$2,030.16	\$1,945.57	\$1,860.98	69
							<a href="#">PE80L2008</a>	\$1,799.20	\$1,727.23	\$1,655.26	\$1,583.30	70	

## PIN-PIN



Frequency Range (GHz.)	Limiting Threshold Typ. (dBm)	Leakage @1W CW Input Max. (dBm)	Insertion Loss Max. (dBm)	Input VSWR Typ.	In Power (CW) Max. (W)	In Peak Power Max. (W)	Model No	1 Pc. Price	See Web for Volume Pricing	ROW
500 MHz - 1	12	20	0.4	1.4:1	1	100	<a href="#">PE8017</a>	\$488.87	See Web for Volume Pricing	71
500 MHz - 2		19	0.5	1.4:1			<a href="#">PE8018</a>	\$503.82		72
1 - 2	9	19	0.2	1.2:1			<a href="#">PE8019</a>	\$531.48		73
2 - 4	12	19	0.8	1.5:1			<a href="#">PE8020</a>	\$469.72		74
2 - 8	9	16	1.2	1.6:1			<a href="#">PE8021</a>	\$603.39		75
2 - 18	12	18	2.5	2.2:1			<a href="#">PE8022</a>	\$608.41		76
4 - 8	9	16	1	1.3:1			<a href="#">PE8023</a>	\$563.38		77
6 - 18	12	16	2.2	2:1			<a href="#">PE8024</a>	\$586.93		78
7 - 12		16	1.8	1.8:1			<a href="#">PE8025</a>	\$560.36		79
8 - 16		16	2	2:1			<a href="#">PE8026</a>	\$533.67		80
11 - 18	9	16	2	2:1			<a href="#">PE8027</a>	\$640.44		81

## PIN-Schottky



Frequency Range (GHz.)	Limiting Threshold Typ. (dBm)	Leakage @1W CW Input Max. (dBm)	Insertion Loss Max. (dBm)	Input VSWR Typ.	In Power (CW) Max. (W)	In Peak Power Max. (W)	Model No	1 Pc. Price	See Web for Volume Pricing	ROW	
500 MHz - 1	12	14	0.5	1.4:1	1	100	<a href="#">PE8028</a>	\$463.58	See Web for Volume Pricing	82	
500 MHz - 2	9	14	0.4	1.25:1		200	<a href="#">PE8029</a>	\$512.36		83	
						100	<a href="#">PE8030</a>	\$628.88		84	
1 - 2	4	14	0.6	1.4:1		200	<a href="#">PE8031</a>	\$590.60		85	
2 - 4	9	14	0.8	1.5:1			<a href="#">PE8032</a>	\$543.79		86	
2 - 8		14	1.2	1.4:1			<a href="#">PE8033</a>	\$597.14		87	
2 - 18	4	18	2.5	2.2:1		100	<a href="#">PE8034</a>	\$612.47		88	
4 - 8		13	1.4	1.5:1			<a href="#">PE8035</a>	\$325.54		89	
6 - 18		13	2.5	2.2:1			<a href="#">PE8036</a>	\$592.43		90	
7 - 12		16	1.6	1.6:1			200	<a href="#">PE8037</a>		\$738.24	91
8 - 16		9	12	2				1.5:1			

See Our Website For Current Pricing & Real-Time Stock Availability!

Limiters & Detectors



Technical Support  
+1 (949) 261-1920



Same-Day Shipping,  
Even Custom Cable Assemblies

# DETECTORS

## Biased Detectors



Frequency Range (GHz.)	Polarity	Voltage Sensitivity (mV/mW)	Flatness (dB)	Input Power (dBm)	TSS (dBm)	Model No	1 Pc. Price	See Web for Volume Pricing		R O W
500 MHz - 1	Negative	1,800	0.25	23	-54	<a href="#">PE8001</a>	\$645.68	See Web for Volume Pricing		92
	Positive		0.5			<a href="#">PE8001-P</a>	\$636.89			93
1 - 2	Negative	2,000	0.25			<a href="#">PE8002</a>	\$488.87			94
	Positive		<a href="#">PE8002-P</a>			\$801.52	95			
2 - 4	Negative		<a href="#">PE8003</a>			\$714.49	96			
	Positive		<a href="#">PE8003-P</a>			\$712.46	97			
4 - 8	Negative		<a href="#">PE8044</a>		\$551.98	98				
	Positive		<a href="#">PE8004-P</a>		\$546.85	99				
6 - 18	Negative	1,600	0.8		<a href="#">PE8005</a>	\$686.29	1			
	Positive	<a href="#">PE8005-P</a>	\$601.53		2					
8 - 12	Negative	1,800	0.5		<a href="#">PE8006</a>	\$745.18	3			
	Positive		<a href="#">PE8006-P</a>		\$711.48	4				
8 - 16	Negative		<a href="#">PE8007</a>	\$527.94	5					
	Positive		<a href="#">PE8007-P</a>	\$677.09	6					
8 - 18	Negative		1,600	0.7	<a href="#">PE8008</a>	\$628.88	7			
	Positive		<a href="#">PE8008-P</a>	\$631.61	8					
18 - 26	Negative	1,500	1	<a href="#">PE8009</a>	\$593.00	9				
	Positive			<a href="#">PE8009-P</a>	\$764.30	10				

## Finline Detectors



Frequency Range (GHz.)	Output Polarity	Input Power (dBm)	Video Output Typ. (V)	Voltage Sensitivity (mV/mW)	Model No	1	2-4	5-9	10+	R O W
100 MHz - 12.4	Positive	27	+10.5	800	<a href="#">PE80T1004</a>	\$1,075.42	\$1,032.40	\$989.39	\$946.37	11
100 MHz - 18	Positive		+10		<a href="#">PE80T1005</a>	\$1,277.81	\$1,226.70	\$1,175.59	\$1,124.47	12

## Log Detectors



Frequency Range (GHz.)	Imp. (Ohm)	Slope (mV/dB)	Input Power Max. (dBm)	Output Voltage Max. (dB)	Slew Rate (V/us)	Model No	1-4	5-9	10-24	25+	R O W
10 MHz - 3	50	40	10	2	1	<a href="#">PE8040</a>	\$554.22	\$526.51	\$498.80	\$476.63	13

## Phase Detectors



Frequency Range (GHz.)	Input Power Max. (dBm)	VSWR Max.	DC Voltage	Model No	1	2-4	5-9	10+	R O W
3 MHz - 300 MHz	17	17	15	<a href="#">PE80T4000</a>	\$1,335.99	\$1,282.55	\$1,229.11	\$1,175.67	14
5 MHz - 25 MHz				<a href="#">PE80T4002</a>	\$1,116.44	\$1,071.78	\$1,027.12	\$982.47	15
200 MHz - 800 MHz	10	10		<a href="#">PE80T4001</a>	\$1,461.56	\$1,403.10	\$1,344.64	\$1,286.17	16

See Our Website For Current Pricing & Real-Time Stock Availability!

Limiters & Detectors

### Power Detectors



Frequency Range (GHz.)	Dynamic Range (dB)	True RMS Output Voltage Typ (V)	Output Slope	VSWR	Max RF Input Power (dBm)	RF Connectors	Model No	1	2-4	5-9	10+	ROW
30 MHz - 4	80	0.62 - 1.89	Positive	1.5:1	20	SMA Female	<a href="#">PE80P1001</a>	\$684.74	\$643.66	\$609.42	\$582.03	17
50 MHz - 3	60	0.12 - 2.1		1.3:1	10		<a href="#">PE80P1002</a>	\$684.74	\$643.66	\$609.42	\$582.03	18
50 MHz - 5	30	0.15 - 4.95		1.4:1	15		<a href="#">PE80P1000</a>	\$684.74	\$643.66	\$609.42	\$582.03	19

### Schottky Zero Bias Detectors



Frequency Range (GHz.)	Imp. (Ohm)	Polarity	Voltage Sensitivity (mV/mW)	VSWR Max	Video Capacitance (pF)	Signal Level & Level Min Input (dBm)	Model No	1 Pc. Price	See Web for Volume Pricing			ROW
10 MHz - 2	50	Negative	500	1.2:1	470	-30	<a href="#">PE8010</a>	\$617.93	See Web for Volume Pricing			20
10 MHz - 4				1.3:1			<a href="#">PE8011</a>	\$567.43				21
10 MHz - 12.4				Positive			1.6:1	<a href="#">PE8012</a>				\$539.24
		1.7:1	<a href="#">PE8012P</a>		\$555.83		23					
			<a href="#">PE8012-P</a>		Call		24					
10 MHz - 18		Negative	450	100	1.7:1		<a href="#">PE80T1003</a>	\$857.92				25
10 MHz - 18.5							<a href="#">PE8013</a>	\$655.14				26
10 MHz - 26.5			500	1.45:1	20		<a href="#">PE8014</a>	\$714.56				27
2 - 4							<a href="#">PE8015</a>	\$620.39				28
2 - 8							<a href="#">PE8016</a>	\$628.88				29

### Threshold Detectors



Frequency Range (GHz.)	Imp. (Ohm)	Signal Level & Input Level Min. (dBm)	Input Power Max. (dBm)	Propagation Delay Typ. (ns)	DC Voltage	Model No	1	2-4	5-9	10+	ROW
2 - 18	50	-20	10	15	15	<a href="#">PE80T1000</a>	\$4,382.77	\$4,207.46	\$4,032.15	\$3,856.84	30
		-45		20	12	<a href="#">PE80T1001</a>	\$7,162.21	\$6,875.72	\$6,589.23	\$6,302.74	31
16 - 40		-20	17	15	<a href="#">PE80T1002</a>	\$5,670.33	\$5,443.52	\$5,216.70	\$4,989.89	32	

### Tunnel Diode Zero Bias Detectors



Frequency Range (GHz.)	Output Polarity	VSWR Max	Pulse Video Response Risetime Typ. (ns)	Voltage Sensitivity Typ. (mV/mW)	Flatness Max. (dB)	Input Power Max. (dBm)	Video Capacitance Typ. (pF)	Model No	1 Pc. Price	See Web for Volume Pricing			ROW				
100 MHz - 2	Negative	2:1	5	800	0.75	17	470	<a href="#">PE80T6000</a>	\$481.40	See Web for Volume Pricing			33				
	Positive							<a href="#">PE80T6001</a>	\$481.40				34				
100 MHz - 4	Negative	2.2:1						1,000	0.5				17	100	<a href="#">PE80T6002</a>	\$510.00	35
	Positive														<a href="#">PE80T6003</a>	\$510.00	36
500 MHz - 1	Negative	2:1						400	1				17	50	<a href="#">PE80T6010</a>	\$383.33	37
	Positive														<a href="#">PE80T6011</a>	\$383.33	38
500 MHz - 18	Negative	3.5:1		1,000	0.5	17	20	<a href="#">PE80T6004</a>	\$1,163.33				39				
	Positive							<a href="#">PE80T6005</a>	\$1,163.33				40				
1 - 2	Negative	2:1		1,000	0.5	17	50	<a href="#">PE80T6012</a>	\$476.67				41				
	Positive							<a href="#">PE80T6013</a>	\$476.67				42				
2 - 4	Negative	2.5:1		500	1	17	20	<a href="#">PE80T6014</a>	\$490.00				43				
	Positive							<a href="#">PE80T6015</a>	\$490.00				44				
2 - 6	Negative	3.5:1	500	1	17	20	<a href="#">PE80T6016</a>	\$500.00	45								
	Positive						<a href="#">PE80T6017</a>	\$500.00	46								
2 - 18	Negative	3.5:1	500	1	17	20	<a href="#">PE80T6006</a>	\$704.37	47								
	Positive						<a href="#">PE80T6007</a>	\$703.06	48								



Technical Support  
+1 (949) 261-1920



Same-Day Shipping,  
Even Custom Cable Assemblies

## Tunnel Diode Zero Bias Detectors



Frequency Range (GHz.)	Output Polarity	VSWR Max	Pulse Video Response Rise Time Typ. (ns)	Voltage Sensitivity Typ. (mV/mW)	Flatness Max. (dB)	Input Power Max. (dBm)	Video Capacitance Typ. (pF)	Model No	1-4	5-9	10-24	25+	ROW		
4 - 8	Negative	2.5:1	5	900	0.7	17	10	<a href="#">PE80T6018</a>	\$529.89	\$503.40	\$476.90	\$455.71	49		
	Positive							<a href="#">PE80T6019</a>	\$529.89	\$503.40	\$476.90	\$455.71	50		
6 - 12	Negative	2.7:1				800		0.6	17	<a href="#">PE80T6020</a>	\$590.00	\$560.50	\$531.00	\$507.40	51
	Positive									<a href="#">PE80T6021</a>	\$613.01	\$582.36	\$551.71	\$527.19	52
6 - 18	Negative	3:1				700		0.75	17	<a href="#">PE80T6008</a>	\$656.67	\$623.84	\$591.00	\$564.74	53
	Positive									<a href="#">PE80T6009</a>	\$682.28	\$648.17	\$614.05	\$586.76	54
12 - 18	Negative			0.7	17				<a href="#">PE80T6022</a>	\$683.33	\$649.16	\$615.00	\$587.66	55	
	Positive								<a href="#">PE80T6023</a>	\$709.98	\$674.48	\$638.98	\$610.58	56	
18 - 26	Negative			4:1	400	1		17	5	<a href="#">PE80T6024</a>	\$793.33	\$753.66	\$714.00	\$682.26	57
	Positive									<a href="#">PE80T6025</a>	\$793.33	\$753.66	\$714.00	\$682.26	58

## NOISE SOURCES



Frequency Range (MHz.)	Design	Noise Output (ENR dB)	Connector	Model No	1	2-4	5-9	10+	ROW	
100 - 60,000	Calibrated	15.5	1.85mm Male	<a href="#">PE85N1009</a>	\$17,714.00	\$17,005.44	\$16,296.88	\$15,588.32	59	
100 - 40,000			2.92mm Male	<a href="#">PE85N1008</a>	\$8,336.31	\$8,002.86	\$7,669.41	\$7,335.95	60	
10 - 26,000			3.5mm Male	<a href="#">PE85N1007</a>	\$5,272.93	\$5,062.01	\$4,851.10	\$4,640.18	61	
10 - 18,000	Calibrated		SMA Male	SMA Male	<a href="#">PE85N1006</a>	\$3,771.19	\$3,620.34	\$3,469.49	\$3,318.65	62
2,000 - 4,000				<a href="#">PE8501</a>	\$1,709.32	\$1,640.95	\$1,572.57	\$1,504.20	63	
8,000 - 12,000				<a href="#">PE8503</a>	\$1,819.56	\$1,746.78	\$1,674.00	\$1,601.21	64	
12,000 - 18,000				<a href="#">PE8504</a>	\$2,099.50	\$2,015.52	\$1,931.54	\$1,847.56	65	
1,000 - 2,000				<a href="#">PE8505</a>	\$1,390.12	\$1,334.52	\$1,278.91	\$1,223.31	66	
2,000 - 4,000				<a href="#">PE8506</a>	\$1,514.30	\$1,453.73	\$1,393.16	\$1,332.58	67	
4,000 - 8,000				<a href="#">PE8507</a>	\$1,712.46	\$1,643.96	\$1,575.46	\$1,506.96	68	
8,000 - 12,000				<a href="#">PE8508</a>	\$2,014.38	\$1,933.80	\$1,853.23	\$1,772.65	69	
12,000 - 18,000				<a href="#">PE8509</a>	\$1,779.12	\$1,707.96	\$1,636.79	\$1,565.63	70	
1 - 2,000	Calibrated, Amplified, Bench Top	30	SMA Female	<a href="#">PE85N1017</a>	\$16,564.36	\$15,901.79	\$15,239.21	\$14,576.64	71	
10 - 3,000				<a href="#">PE85N1018</a>	\$18,409.02	\$17,672.66	\$16,936.30	\$16,199.94	72	
0.01 - 2,000	Calibrated	SMA Female	<a href="#">PE85N1019</a>	\$2,417.89	\$2,321.17	\$2,224.46	\$2,127.74	73		
10 - 6,000			<a href="#">PE85N1020</a>	\$2,448.70	\$2,350.75	\$2,252.80	\$2,154.86	74		
1,000 - 18,000			<a href="#">PE85N1021</a>	\$3,031.39	\$2,910.13	\$2,788.88	\$2,667.62	75		
3,700 - 4,200			<a href="#">PE85N1022</a>	\$3,508.42	\$3,368.08	\$3,227.75	\$3,087.41	76		
7,200 - 8,400			<a href="#">PE85N1014</a>	\$3,508.42	\$3,368.08	\$3,227.75	\$3,087.41	77		
10,700 - 12,700			<a href="#">PE85N1015</a>	\$3,629.63	\$3,484.44	\$3,339.26	\$3,194.07	78		
0.01 - 2,000	Calibrated	SMA Female	<a href="#">PE85N1016</a>	\$4,115.90	\$3,951.26	\$3,786.63	\$3,621.99	79		
0.1 - 500			<a href="#">PE85N1000</a>	\$2,508.10	\$2,407.78	\$2,307.45	\$2,207.13	80		
10 - 2,000			<a href="#">PE85N1001</a>	\$2,544.20	\$2,442.43	\$2,340.66	\$2,238.90	81		
10 - 3,000			<a href="#">PE85N1010</a>	\$3,127.74	\$3,002.63	\$2,877.52	\$2,752.41	82		
10 - 6,000			Calibrated, Amplified	<a href="#">PE85N1011</a>	\$3,284.00	\$3,152.64	\$3,021.28	\$2,889.92	83	
				<a href="#">PE85N1012</a>	\$3,900.42	\$3,744.40	\$3,588.39	\$3,432.37	84	
10 - 6,000			Calibrated	<a href="#">PE85N1002</a>	\$3,031.39	\$2,910.13	\$2,788.88	\$2,667.62	85	
				<a href="#">PE85N1003</a>	\$3,428.72	\$3,291.57	\$3,154.42	\$3,017.27	86	
				<a href="#">PE85N1013</a>	\$4,956.03	\$4,757.79	\$4,559.55	\$4,361.31	87	
1,000 - 18,000			Calibrated	<a href="#">PE85N1004</a>	\$3,645.25	\$3,499.44	\$3,353.63	\$3,207.82	88	
	<a href="#">PE85N1005</a>	\$3,789.23		\$3,637.66	\$3,486.09	\$3,334.52	89			



## PHASE SHIFTERS AND TRIMMERS

### Adjustable Phase Trimmers



Connector	Gender	Frequency Range (MHz.)	Deg. Phase Adjustment per GHz	Max. Insertion Loss (dB)	Model No	1-9	10-24	25-49	50+	ROW
SMA	Male	DC - 18,000	10	3.4	<a href="#">PE8203</a>	\$193.12	\$183.46	\$173.81	\$166.08	90

### 8 Bit Programmable Phase Shifter



Connector	Gender	Frequency Range (MHz.)	Deg. Phase Adjustment per GHz	Max. Insertion Loss (dB)	Model No	1	2-4	5-9	10+	ROW	
2.92mm SMA	Female	32,000 - 37,000			<a href="#">PE82P5003</a>	\$14,477.64	\$13,898.53	\$13,319.43	\$12,740.32	91	
		500 - 2,000			13	<a href="#">PE82P5000</a>	\$8,563.01	\$8,220.49	\$7,877.97	\$7,535.45	92
		6,000 - 18,000			12	<a href="#">PE82P5002</a>	\$14,723.68	\$14,134.73	\$13,545.79	\$12,956.84	93
		8,500 - 11,000				<a href="#">PE82P5001</a>	\$9,053.03	\$8,690.91	\$8,328.79	\$7,966.67	94

### Adjustable Phase Shifter



Connector	Gender	Frequency Range (MHz.)	Deg. Phase Adjustment per GHz	Max. Insertion Loss (dB)	Model No	1 Pc. Price	See Web for Volume Pricing			ROW
2.92mm SMA	Female	18,000 - 40,000	60		<a href="#">PE82P1000</a>	\$2,842.79	See Web for Volume Pricing			95
		DC - 2,300			<a href="#">PE8243</a>	\$905.52				96
		DC - 4,300			<a href="#">PE8244</a>	\$1,068.59				97
		DC - 8,200			<a href="#">PE8245</a>	\$1,051.34				98
		DC - 12,700			<a href="#">PE8246</a>	\$1,151.24				99
		DC - 18,000			<a href="#">PE8247</a>	\$1,183.89				1
		18,000 - 26,500			<a href="#">PE8255</a>	\$1,537.34				2
					<a href="#">PE8253</a>	\$1,298.75				3

### Analog Phase Shifter



Connector	Gender	Frequency Range (MHz.)	Deg. Phase Adjustment per GHz	Max. Insertion Loss (dB)	Model No	1	2-4	5-9	10+	ROW
SMA	Female	5,000 - 18,000	40	12	<a href="#">PE82P2000</a>	\$5,940.99	\$5,703.35	\$5,465.71	\$5,228.07	4
		6,000 - 15,000	120	10	<a href="#">PE82P2001</a>	\$5,491.06	\$5,271.42	\$5,051.78	\$4,832.13	5

## POWER DIVIDERS

### 50 Ohm



Ports	Freq. Range (MHz.)	Connector	Gender	Maximum Power (W)	Model No	1-9	10-24	25-49	50+	ROW
<b>2 WAY</b>	Female	350-6,000	SMA	30	<a href="#">PE20DV1053</a>	\$277.07	\$263.22	\$249.36	\$238.28	6



### 50 Ohm



Ports	Freq. Range (MHz.)	Connector	Gender	Maximum Power (W)	Model No	1 Pc. Price	See Web for Volume Pricing	ROW		
<b>2 WAY</b>	Female	2,000-18,000	N	30	<a href="#">PE20DV1049</a>	\$619.94	See Web for Volume Pricing	7		
			SMA		<a href="#">PE20DV1044</a>	\$332.48		8		
					<a href="#">PE20DV1045</a>	\$131.61		9		
<b>4 WAY</b>	Female	4,000-8,000	N	30	<a href="#">PE20DV1051</a>	\$306.67		See Web for Volume Pricing	10	
			SMA		<a href="#">PE20DV1046</a>	\$193.95			11	
					<a href="#">PE20DV1047</a>	\$193.95			12	
					<a href="#">PE20DV1048</a>	\$443.31			13	
					<a href="#">PE20DV1050</a>	\$436.38			14	
<b>8 WAY</b>	Female	5-500	N	10	<a href="#">PE20DV1052</a>	\$512.57			See Web for Volume Pricing	15

### Resistive



Ports	Freq. Range (MHz.)	Connector	Gender	Maximum Power	Model No	1 Pc. Price	See Web for Volume Pricing	ROW
<b>2 WAY</b>	Male	0-6,000	SMA	2	<a href="#">PE2082</a>	\$310.42	See Web for Volume Pricing	16
			2.92mm		<a href="#">PE2063</a>	\$475.74		17
			SMA		<a href="#">PE2067</a>	\$459.24		18
			2.92mm		<a href="#">PE2064</a>	\$551.27		19
			N		<a href="#">PE2066</a>	\$512.88		20
	Female	0-18,000	SMA	1	<a href="#">PE2068</a>	\$504.01		21
					<a href="#">PE2084</a>	\$340.47		22
	Male	0-26,500	2.92mm		<a href="#">PE2065</a>	\$725.44		23
	Female				<a href="#">PE2083</a>	\$693.88		24

### Reactive



Ports	Freq. Range (MHz.)	Connector	Gender	Maximum Power (W)	Model No	1 Pc. Price	See Web for Volume Pricing	ROW				
<b>2 WAY</b>	Female	2-500	BNC	1	<a href="#">PE2000</a>	\$241.30	See Web for Volume Pricing	25				
			N	1	<a href="#">PE2044</a>	\$523.87		26				
			SMA	1	<a href="#">PE2070</a>	\$463.64		27				
			N	1	<a href="#">PE2047</a>	\$518.46		28				
			Male	10-1,000	7/16 DIN			3	<a href="#">PE20DV1041</a>	\$195.60	29	
								10	<a href="#">PE2032</a>	\$605.78	30	
				SMA	500-1,000				30	<a href="#">PE20DV019</a>	\$121.86	31
									20	<a href="#">PE20DV009</a>	\$217.70	32
									20	<a href="#">PE20DV008</a>	\$110.99	33
									30	<a href="#">PE20DV014</a>	\$121.86	34
	20	<a href="#">PE20DV013</a>							\$217.70	35		
	30	<a href="#">PE20DV016</a>							\$121.86	36		
	30	<a href="#">PE20DV000</a>							\$268.40	37		
	20	<a href="#">PE20DV005</a>							\$378.77	38		
	30	<a href="#">PE2028</a>	\$586.73	39								
	Female	7,000-12,400	N		10	<a href="#">PE2081</a>		\$393.41	40			
					10	<a href="#">PE2036</a>		\$681.48	41			
					10	<a href="#">PE2078</a>		\$1,968.02	42			
					12	<a href="#">PE2077</a>		\$1,745.17	43			
					10	<a href="#">PE2079A</a>		\$2,165.06	44			
10					<a href="#">PE2037</a>	\$977.80	45					
<b>3 WAY</b>	Female	376-2,200	N	500	<a href="#">PE20DV1040</a>	\$267.75	See Web for Volume Pricing	46				
					30	<a href="#">PE20DV017</a>		\$199.80	47			
					30	<a href="#">PE20DV001</a>		\$335.87	48			

**Reactive**



Ports	Freq. Range (MHz.)	Connector	Gender	Maximum Power (W)	Model No	1 Pc. Price	See Web for Volume Pricing	R O W
<b>4 WAY</b>	Female	2-500	BNC	1	<a href="#">PE2001</a>	\$431.94	See Web for Volume Pricing	49
			N	1	<a href="#">PE2045</a>	\$781.49		50
		10-1,000	BNC	1	<a href="#">PE2004</a>	\$688.44		51
			N	10	<a href="#">PE2038</a>	\$958.73		52
		500-1,000	SMA	30	<a href="#">PE20DV020</a>	\$193.67		53
				30	<a href="#">PE20DV010</a>	\$232.65		54
		800-2,500	SMA	20	<a href="#">PE20DV012</a>	\$138.20		55
				10	<a href="#">PE2039</a>	\$1,002.07		56
		1,000-2,000	SMA	30	<a href="#">PE20DV015</a>	\$193.67		57
				30	<a href="#">PE2040</a>	\$961.88		58
2,000-4,000	SMA	30	<a href="#">PE20DV018</a>	\$186.44	59			
		30	<a href="#">PE20DV002</a>	\$341.06	60			
2,000-8,000	SMA	30	<a href="#">PE20DV006</a>	\$799.76	61			
		30	<a href="#">PE2043</a>	\$817.25	62			
12,000-18,000	SMA	30	<a href="#">PE2024</a>	\$728.92	63			
		1	<a href="#">PE2006</a>	\$615.68	64			
<b>6 WAY</b>	Female	1-175	BNC	1	<a href="#">PE2006</a>	\$615.68		64
		2,000-8,000	SMA	30	<a href="#">PE20DV003</a>	\$459.64		65
<b>8 WAY</b>	Female	2-500	BNC	1	<a href="#">PE2002</a>	\$903.93		66
			SMA	30	<a href="#">PE20DV011</a>	\$287.39		67
			SMA	30	<a href="#">PE20DV004</a>	\$632.75		68
<b>12 WAY</b>	Female	2-500	BNC	1	<a href="#">PE2005</a>	\$827.96		69

**Wilkinson**



Ports	Freq. Range (MHz.)	Connector	Gender	Maximum Power (W)	Model No	1 Pc. Price	See Web for Volume Pricing	R O W	
<b>2 WAY</b>	Female	10-1,000	BNC	1	<a href="#">PE2003</a>	\$456.12	See Web for Volume Pricing	70	
			SMA	10	<a href="#">PE2008</a>	\$405.10		71	
			SMA	30	<a href="#">PE20S0022</a>	\$409.11		72	
		500-2,000	N	10	<a href="#">PE2092</a>	\$135.87		73	
			SMA	10	<a href="#">PE2088</a>	\$115.45		74	
		800-2,500	SMA	N	50	<a href="#">PE20S0025</a>		\$439.12	75
				10	<a href="#">PE2074</a>	\$275.99		76	
		1,000-2,000	SMA	N	50	<a href="#">PE2033</a>		\$630.01	77
				10	<a href="#">PE2011</a>	\$349.37		78	
		2,000-4,000	SMA	10	<a href="#">PE2034</a>	\$561.60		79	
				10	<a href="#">PE2014</a>	\$293.62		80	
		2,000-8,000	SMA	10	<a href="#">PE2026</a>	\$425.56		81	
				30	<a href="#">PE2035</a>	\$659.39		82	
		Male	4,000-8,000	SMA	10	<a href="#">PE2080</a>		\$403.86	83
					10	<a href="#">PE2020</a>		\$386.17	84
Female	7,000-12,400	SMA	10	<a href="#">PE2027</a>	\$663.63	85			
			10	<a href="#">PE2023</a>	\$422.45	86			
			10	<a href="#">PE2023</a>	\$422.45	86			
<b>3 WAY</b>	Female	2-200	BNC	1	<a href="#">PE2007</a>	\$412.68	See Web for Volume Pricing	87	
			N	10	<a href="#">PE2093</a>	\$218.27		88	
		690-2,700	SMA	10	<a href="#">PE2090</a>	\$205.90		89	
				30	<a href="#">PE20DV1034A</a>	\$295.92		90	
		800-2,500	N	50	<a href="#">PE20S0019</a>	\$490.41		91	
<b>4 WAY</b>	Female	500-1,000	SMA	30	<a href="#">PE2009</a>	\$505.13	See Web for Volume Pricing	92	
				30	<a href="#">PE20S0024</a>	\$436.35		93	
		500-2,000	N	10	<a href="#">PE2094</a>	\$255.44		94	
				10	<a href="#">PE2089</a>	\$226.92		95	
		690-2,700	SMA	10	<a href="#">PE20S0020</a>	\$413.18		96	
				30	<a href="#">PE2012</a>	\$519.50		97	
		1,000-2,000	SMA	10	<a href="#">PE2031</a>	\$597.41		98	
				10	<a href="#">PE2029</a>	\$1,114.34		99	
2,000-8,000	N	10	<a href="#">PE2041</a>	\$861.86	1				
2,000-18,000	SMA	10	<a href="#">PE2021</a>	\$519.70	2				

See Our Website For Current Pricing & Real-Time Stock Availability!

Power Dividers & RF Combiners



Technical Support  
+1 (949) 261-1920



Same-Day Shipping,  
Even Custom Cable Assemblies

### Wilkinson



Ports	Freq. Range (MHz.)	Connector	Gender	Maximum Power (W)	Model No	1 Pc. Price	See Web for Volume Pricing			ROW
<b>8 WAY</b>	Female	500-2,000	SMA	30	<a href="#">PE20S0023</a>	\$567.64	See Web for Volume Pricing			3
		690-2,700	N	10	<a href="#">PE2095</a>	\$419.60				4
		698-2,700	SMA	10	<a href="#">PE2091</a>	\$287.46				5
		800-2,500	N	30	<a href="#">PE20DV1038A</a>	\$685.67				6
			SMA	30	<a href="#">PE20S0021</a>	\$701.98				7

### 75 Ohm

#### Reactive



Ports	Freq. Range (MHz.)	Connector	Gender	Maximum Power (W)	Model No	1 Pc. Price	See Web for Volume Pricing			ROW
<b>2 WAY</b>	Female	2-500	BNC	1	<a href="#">PE2048</a>	\$489.33	See Web for Volume Pricing			8
		10-1,000		1	<a href="#">PE2062</a>	\$242.00				9
<b>4 WAY</b>	Female	2-500	BNC	1	<a href="#">PE2049</a>	\$439.07				10
<b>8 WAY</b>	Female	2-500	BNC	1	<a href="#">PE2061</a>	\$735.95				11

### RF COMBINERS

#### Broadband



Frequency Range (GHz)	Ports	Connector 1	Connector 2	Power Rating	Isolation (dB)	Model No	1 Pc. Price	See Web for Volume Pricing			ROW
20 MHz - 1	2	N Female	N Female	500 W	10	<a href="#">PE20S0004</a>	\$2,327.19	See Web for Volume Pricing			12
		SMA Female	SMA Female	100 W	15	<a href="#">PE20S0001</a>	\$1,183.40				13
80 MHz - 1	4	N Female	N Female	300 W	12	<a href="#">PE20S0003</a>	\$2,338.50				14
		SMA Female	SMA Female	200 W		<a href="#">PE20S0002</a>	\$1,637.54				15
500 MHz - 2.5	2	SMA Female	N Female	500 W	-12	<a href="#">PE20S0006</a>	\$2,432.04				16
			SMA Female	200 W		<a href="#">PE20S0005</a>	\$1,637.54				17
800 MHz - 2.5	2	N Female	N Female	600 W	13	<a href="#">PE20S0007</a>	\$1,684.20				18
			SC Female	800 W		<a href="#">PE20S0011</a>	\$2,188.84				19
800 MHz - 4.2	4	SMA Female	N Female	600 W	6	<a href="#">PE20S0009</a>	\$2,385.27				20
			SMA Female	200 W	12	<a href="#">PE20S0008</a>	\$1,927.41				22
1 - 6	2	SMA Female	N Female	200 W	10	<a href="#">PE20S0012</a>	\$2,218.33				23
			SMA Female	100 W	8	<a href="#">PE20S0013</a>	\$2,180.39				24
2 - 6	4	SMA Female	SMA Female	100 W	6	<a href="#">PE20S0014</a>	\$1,825.76				25
			N Female	400 W	12	<a href="#">PE20S0015</a>	\$819.94				26
			N Female	400 W		<a href="#">PE20S0017</a>	\$2,444.90				27
			SMA Female	100 W	10	<a href="#">PE20S0016</a>	\$994.95				28

### ROTARY JOINTS



Connector A	Connector B	Max. Frequency (MHz.)	Input Power	VSWR	Model No	1-9	10-24	25-49	50+	ROW
2.92mm	2.92mm	DC - 18,000	30 WATT	1.4:1	<a href="#">PE1400</a>	\$175.49	\$166.72	\$157.94	\$150.92	29
					<a href="#">PE1402</a>	\$163.79	\$157.24	\$152.32	\$149.05	30
SMA	PCB	DC - 6,000		1.15:1	<a href="#">PE1401</a>	\$146.24	\$138.93	\$131.62	\$125.77	31

# SURGE PROTECTORS

## In-Line Surge Protectors

See Our Website For Current Pricing & Real-Time Stock Availability!

Surge Protectors



Impedance	Connector	Gender	Frequency Range (MHz.)	Mount Type	Maximum Power	Model No	1 Pc. Price	See Web for Volume Pricing	ROW	
50 Ohm	4.3-10	Female to Female	698 - 2,700	Bulkhead	500 Watt	<a href="#">PE73SP1051</a>	\$153.77	See Web for Volume Pricing	32	
		Female to Male		Bulkhead		<a href="#">PE73SP1061</a>	\$173.84		33	
		Male to Female		Bulkhead		<a href="#">PE73SP1062</a>	\$173.84		34	
	7/16 DIN	Female to Female	100 - 512	None	750 Watt	<a href="#">PE73SP1037</a>	\$168.32		35	
			698 - 2,700	Bulkhead	1000 Watt	<a href="#">PE73SP1004</a>	\$147.86		36	
			800 - 2,250	Bulkhead	500 Watt	<a href="#">PE73SP1063</a>	\$111.52		37	
		698 - 2,160	1000 Watt		<a href="#">PE73SP1008</a>	\$159.06	38			
		698 - 2,700	500 Watt		<a href="#">PE73SP1006</a>	\$147.28	39			
			500 Watt	<a href="#">PE73SP1007</a>	\$159.06	40				
			100 - 512	None	750 Watt	<a href="#">PE73SP1034</a>	\$168.32		41	
		Male to Female	800 - 2,250	None	300 Watt	<a href="#">PE73SP1017</a>	\$153.11		42	
			800 - 2,500		50 Watt	<a href="#">PE73SP1040</a>	\$83.38		43	
			DC - 2,400		2000 Watt	<a href="#">PE7301-4</a>	\$188.53		44	
		Female to Female	DC - 3,000	None	Bulkhead	200 Watt	<a href="#">PE7301-1</a>		\$168.23	45
						2000 Watt	<a href="#">PE7301-2</a>		\$174.94	46
	40 Watt					<a href="#">PE73SP1039</a>	\$64.80		47	
	DC - 7,000			Bulkhead	90 Watt	<a href="#">PE73SP1038</a>	\$49.56		48	
					2000 Watt	<a href="#">PE73SP1021</a>	\$70.22		49	
					2000 Watt	<a href="#">PE73SP1025</a>	\$70.22		50	
	1.5 - 700		None	Bulkhead	3000 Watt	<a href="#">PE73SP1030</a>	\$84.94		51	
					500 Watt	<a href="#">PE73SP1027</a>	\$114.51		52	
					1500 Watt	<a href="#">PE73SP1024</a>	\$77.43		53	
			10 - 1,000	None	Bulkhead	100 Watt	<a href="#">PE73SP1015</a>		\$161.42	54
						750 Watt	<a href="#">PE73SP1018</a>		\$161.42	55
						750 Watt	<a href="#">PE73SP1033</a>		\$117.82	56
	40 - 400			None	Bulkhead	200 Watt	<a href="#">PE73SP1029</a>		\$114.51	57
						500 Watt	<a href="#">PE73SP1022</a>		\$84.94	58
						300 Watt	<a href="#">PE73SP1019</a>		\$141.39	59
			100 - 512	Bulkhead	Bulkhead	500 Watt	<a href="#">PE73SP1000</a>		\$105.61	60
						300 Watt	<a href="#">PE73SP1065</a>		\$95.37	61
						300 Watt	<a href="#">PE73SP1010</a>		\$141.39	62
	800 - 2,500	None		Bulkhead	300 Watt	<a href="#">PE73SP1013</a>	\$141.39		63	
					300 Watt	<a href="#">PE73SP1014</a>	\$141.39		64	
					10 Watt	<a href="#">PE73SP1050</a>	\$107.59		65	
		DC - 2,400	None	Bulkhead	50 Watt	<a href="#">PE73SP1042</a>	\$83.38		66	
					90 Watt	<a href="#">PE73SP1041</a>	\$49.56		67	
					500 Watt	<a href="#">PE73SP1001</a>	\$105.61		68	
	698 - 2,700		None	Bulkhead	500 Watt	<a href="#">PE73SP1002</a>	\$116.73		69	
					10 Watt	<a href="#">PE73SP1049</a>	\$61.21		70	
					1500 Watt	<a href="#">PE73SP1028</a>	\$77.43		71	
		2,000 - 6,000	None	Bulkhead	750 Watt	<a href="#">PE73SP1036</a>	\$117.82		72	
					375 Watt	<a href="#">PE73SP1023</a>	\$70.22		73	
					500 Watt	<a href="#">PE73SP1031</a>	\$84.94		74	
	800 - 2,250		None	Bulkhead	500 Watt	<a href="#">PE73SP1066</a>	\$95.37		75	
					300 Watt	<a href="#">PE73SP1011</a>	\$141.39		76	
					300 Watt	<a href="#">PE73SP1069</a>	\$44.06		77	
		SMA	Female RP to Male RP	DC - 5,800	None	Bulkhead	<a href="#">PE73SP1068</a>		\$44.06	78
			Female to Female				<a href="#">PE73SP1067</a>		\$44.06	79
			Female to Male				<a href="#">PE73SP1067</a>		\$44.06	80
	TNC	Female to Female	800 - 2,500	None	Bulkhead	<a href="#">PE73SP1016</a>	\$141.39		81	
UHF	<a href="#">PE73SP1026</a>					\$74.75	82			
			1.5 - 700	Bulkhead	2000 Watt	<a href="#">PE73SP1032</a>	\$82.05	83		

### Surge Protector Replacement Cartridges

Cartridge For	Maximum Power	Model No	1-24	25-49	50-99	100+	ROW
PE7301	2,000 Watt	<a href="#">PE7301-2000CART</a>	\$30.09	\$28.59	\$27.08	\$25.88	90
	200 Watt	<a href="#">PE7301-200CART</a>	\$33.44	\$31.77	\$30.10	\$28.76	91
PE7139 & PE7140	1,500 Watt	<a href="#">PE7139-CART</a>	\$20.37	\$19.56	\$18.94	\$18.54	92

# INDEX GUIDE TO SWITCHES

<b>SWITCHES.....</b>	<b>288</b>
<b>ELECTROMECHANICAL RELAY SWITCHES.....</b>	<b>288</b>
1M Life Cycles.....	288
2M Life Cycles.....	291
2.5M Life Cycles.....	292
5M Life Cycles.....	293
10M Life Cycles.....	294
Special Applications.....	294
<b>GaN HIGH POWER SWITCHES.....</b>	<b>299</b>
<b>HIGH ISOLATION SWITCHES.....</b>	<b>299</b>
<b>HIGH ISOLATION USB SWITCHES.....</b>	<b>299</b>
<b>MANUAL SWITCHES.....</b>	<b>295</b>
<b>PIN DIODE SWITCHES.....</b>	<b>295</b>
SPST.....	295
SPDT.....	295
SP3T.....	296
SP4T.....	297
SP5T.....	298
SP6T.....	298
SP8T.....	298
SP12T.....	298
Transfer.....	298
<b>SMT PACKAGED ELECTROMECHANICAL SWITCHES.....</b>	<b>294</b>

## Electromechanical Relay Switches

### 1M Life Cycles



**Features:**  
A: Absorptive  
AR: Auto Reset  
F: Fail-safe  
D: Diode  
GR: Global Reset  
H: Hot Switches  
I: Indicators  
L: Latching  
NO: Normally Open  
NT: Non-Terminated  
P: Pulse  
R: Reflective  
RS: Reset  
S: Self Cut Off  
T: Terminated  
TTL: TTL Logic

Max Frequency (GHz)	Switch Type	Connector Type	Features	Min Isolation (dB)	Max IL (dB)	Voltage (V)	RF Power (W CW)	Model No	1 Pc. Price	See Web for Volume Pricing	R O W
8 GHz	SP6T	TNC Female	NO/NT	60	0.6	28	50	<a href="#">PE71S6207</a>	\$1,823.50	See Web for Volume Pricing	1
				70		12		<a href="#">PE71S6206</a>	\$1,823.50		2
10 GHz	SPDT	TNC Female	F/I, TTL, D, NT	60	0.6	12	50	<a href="#">PE71S6200</a>	\$1,094.10		3
						28		<a href="#">PE71S6201</a>	\$1,094.10		4
			12			<a href="#">PE71S6198</a>		\$920.24	5		
			28			<a href="#">PE71S6199</a>		\$1,362.64	6		
	SP4T	N Female	NO/I, TTL, D, NT	60	0.6	12	160	<a href="#">PE71S6184</a>	\$1,735.98		7
						28		<a href="#">PE71S6185</a>	\$1,735.98		8
						12		<a href="#">PE71S6193</a>	\$2,942.86		9
						28		<a href="#">PE71S6190</a>	\$2,298.88		10
						12		<a href="#">PE71S6183</a>	\$1,336.89		11
						28		<a href="#">PE71S6191</a>	\$1,713.82		12
	SP6T	N Female	NO/I, TTL, D, NT	60	0.6	12	50	<a href="#">PE71S6188</a>	\$1,984.48		13
						160		<a href="#">PE71S6196</a>	\$2,344.50		14
						28		<a href="#">PE71S6189</a>	\$1,909.99		15
						160		<a href="#">PE71S6197</a>	\$2,435.94		16
12						<a href="#">PE71S6186</a>		\$1,579.68	17		
160						<a href="#">PE71S6194</a>		\$1,875.60	18		
10 GHz	SPDT	N Female	NO/NT	60	0.6	12	50	<a href="#">PE71S6187</a>	\$1,579.68		19
28						<a href="#">PE71S6195</a>		Call	20		
12.4 GHz	SPDT	N Female	F/I, TTL, D, NT	60	0.6	12	45	<a href="#">PE71S6152</a>	\$1,118.37	21	

Switches

1M Life Cycles



**Features:**  
 A: Absorptive  
 AR: Auto Reset  
 F: Failsafe  
 D: Diode  
 GR: Global Reset  
 H: Hot Switches  
 I: Indicators  
 L: Latching  
 NO: Normally Open  
 NT: Non-Terminated  
 P: Pulse  
 R: Reflective  
 RS: Reset  
 S: Self Cut Off  
 T: Terminated  
 TTL: TTL Logic

Max Frequency (GHz)	Switch Type	Connector Type	Features	Min Isolation (dB)	Max IL (dB)	Voltage (V)	RF Power (W CW)	Model No	1 Pc. Price	See Web for Volume Pricing	ROW						
12.4 GHz	SPDT	N Female	F/I, TTL, D, NT	60	0.6	12	160	<a href="#">PE71S6160</a>	\$1,280.76	See Web for Volume Pricing	23						
						28		<a href="#">PE71S6161</a>	\$1,280.76		24						
					0.5	12	200	<a href="#">PE71S6059</a>	\$627.58		25						
			28				<a href="#">PE71S6058</a>	\$724.13	26								
			0.6		F/NT	12	50	<a href="#">PE71S6150</a>	\$703.71		27						
						160		<a href="#">PE71S6158</a>	\$974.37		28						
						28	50	<a href="#">PE71S6151</a>	\$703.71		29						
			Transfer		N Female	L/I, TTL, D, S, NT	60	0.5	12		50	<a href="#">PE71S6156</a>	\$1,353.30	30			
									160			<a href="#">PE71S6164</a>	\$1,515.69	31			
								28	50		<a href="#">PE71S6157</a>	\$1,302.50	32				
						0.6		L/S, D, NT	160			<a href="#">PE71S6165</a>	\$1,458.80	33			
									12		50	<a href="#">PE71S6154</a>	\$1,172.50	34			
	160			<a href="#">PE71S6162</a>					\$1,364.12		35						
	0.4	L/S, D, NT		F/I, TTL, D, NT		60		0.4	50			<a href="#">PE71S6155</a>	\$1,128.49	36			
									160			<a href="#">PE71S6163</a>	\$1,312.92	37			
								28	50		<a href="#">PE71S6168</a>	\$1,578.63	38				
				F/NT				160			<a href="#">PE71S6176</a>	\$1,840.48	39				
								12	50		<a href="#">PE71S6169</a>	\$1,642.37	40				
								160			<a href="#">PE71S6177</a>	\$1,771.40	41				
			L/I, TTL, S, D, NT	N Female	F/NT		60	0.4	50			<a href="#">PE71S6166</a>	\$1,276.45	42			
									160			<a href="#">PE71S6174</a>	\$1,550.34	43			
								28	50		<a href="#">PE71S6167</a>	\$1,327.32	44				
	L/S, D, NT	TNC Female			F/NT			60	0.6		160		<a href="#">PE71S6175</a>	\$1,492.15	45		
											12	50	<a href="#">PE71S6172</a>	\$1,964.99	46		
160										<a href="#">PE71S6180</a>	\$2,225.91	47					
0.4	F/NT	L/I, TTL, S, D, NT	60	0.4	28	50			<a href="#">PE71S6173</a>	Call	48						
					160				<a href="#">PE71S6181</a>	\$2,142.36	49						
				12	50	<a href="#">PE71S6170</a>			\$1,655.74	50							
0.6	F/NT	L/S, D, NT		60	0.6	160				<a href="#">PE71S6178</a>	\$1,891.23	51					
						28			50	<a href="#">PE71S6171</a>	\$1,720.31	52					
					160				<a href="#">PE71S6179</a>	\$1,966.08	53						
0.6	F/NT	L/S, D, NT			60	0.6	12		50	<a href="#">PE71S6204</a>	\$1,528.62	54					
							28			<a href="#">PE71S6205</a>	\$1,695.42	55					
						12	50		<a href="#">PE71S6202</a>	\$1,354.60	56						
0.4	F/NT	L/S, D, NT				60	0.4	28		<a href="#">PE71S6203</a>	\$1,407.43	57					
								12	20	<a href="#">PE71S6326</a>	\$322.68	58					
							28		<a href="#">PE71S6327</a>	\$340.14	59						
18 GHz	SPDT	SMA Female	F/NT				70	0.4	12	20	<a href="#">PE71S6326</a>	\$322.68	60				
	Transfer		P/I, H, NT				60	0.5	24	35	<a href="#">PE71S6327</a>	\$340.14	61				
22 GHz	SPDT	SMA Female	F/T				60	0.6	20	20	12	<a href="#">PE71S6293</a>	\$1,237.14	62			
				28							<a href="#">PE71S6294</a>	\$1,096.72	63				
				12							<a href="#">PE71S6295</a>	\$1,370.63	64				
			28	<a href="#">PE71S6296</a>							\$2,008.73	65					
			L/S, D, TTL, I, T	F/TTL, I, T	12						<a href="#">PE71S6299</a>	Call	66				
					28						<a href="#">PE71S6300</a>	\$1,476.16	67				
	12				<a href="#">PE71S6297</a>						\$1,877.13	68					
	L/S, D, TTL, T		F/TTL, I, T	28	<a href="#">PE71S6298</a>	\$1,389.33					69						
				12	<a href="#">PE71S6307</a>	\$2,573.74					70						
				28	<a href="#">PE71S6308</a>	\$2,365.34					71						
	22 GHz		SP4T	SMA Female	L/I, TTL, S, D, T	60					0.6	20	20	12	<a href="#">PE71S6305</a>	\$2,392.63	72
														28	<a href="#">PE71S6306</a>	\$2,302.82	73
12		<a href="#">PE71S6306</a>					\$2,302.82	73									

See Our Website For Current Pricing & Real-Time Stock Availability!

Switches

**1M Life Cycles**



**Features:**  
 A: Absorptive  
 AR: Auto Reset  
 F: Failsafe  
 D: Diode  
 GR: Global Reset

H: Hot Switches  
 I: Indicators  
 L: Latching  
 NO: Normally Open  
 NT: Non-Terminated  
 P: Pulse

Latching  
 R: Reflective  
 RS: Reset  
 S: Self Cut Off  
 T: Terminated  
 TTL: TTL Logic

Max Frequency (GHz)	Switch Type	Connector Type	Features	Min Isolation (dB)	Max IL (dB)	Voltage (V)	RF Power (W CW)	Model No	1 Pc. Price	See Web for Volume Pricing	ROW				
22 GHz	SP4T	SMA Female	NO/I, T	60	0.6	28	20	<a href="#">PE71S6302</a>	\$1,927.10	See Web for Volume Pricing	74				
			NO/I, TTL, D, NT			12		<a href="#">PE71S6128</a>	\$1,524.55		75				
						28		<a href="#">PE71S6129</a>	\$1,424.80		76				
			NO/I, TTL, D, T			12		<a href="#">PE71S6303</a>	\$2,522.55		77				
						28		<a href="#">PE71S6304</a>	\$2,427.86		78				
			NO/NT			12		<a href="#">PE71S6126</a>	\$1,254.98		79				
			28			<a href="#">PE71S6127</a>		\$1,291.33	80						
	NO/T		12			<a href="#">PE71S6301</a>		\$1,927.10	81						
	L/I, TTL, S, D, T		28			<a href="#">PE71S6315</a>		\$3,049.13	82						
			12			<a href="#">PE71S6316</a>		\$3,049.13	83						
	L/S, D, T		28			<a href="#">PE71S6313</a>		\$2,761.30	84						
			28			<a href="#">PE71S6314</a>		\$2,761.30	85						
	NO/I, TTL, D, NT		12			<a href="#">PE71S6132</a>		\$1,823.03	86						
			28			<a href="#">PE71S6133</a>		\$1,696.11	87						
	NO/I, TTL, D, T		12			<a href="#">PE71S6311</a>		\$2,774.85	88						
			28			<a href="#">PE71S6312</a>		\$2,774.85	89						
	NO/NT		12			<a href="#">PE71S6130</a>		\$1,544.59	90						
			28			<a href="#">PE71S6131</a>		\$1,443.53	91						
	12	<a href="#">PE71S6309</a>	\$2,302.78	92											
	28	<a href="#">PE71S6310</a>	\$2,216.34	93											
26.5 GHz	SPDT	SMA Female	F/NT	50	0.5	12	20	<a href="#">PE71S6094</a>	\$412.38	See Web for Volume Pricing	94				
				70	0.4	24		<a href="#">PE71S6328</a>	Call		95				
			F/TTL, D, I, NT	50	0.5	12		<a href="#">PE71S6096</a>	\$742.15		96				
						28		<a href="#">PE71S6097</a>	\$553.02		97				
			L/I, TTL, S, D, NT			12		<a href="#">PE71S6100</a>	\$1,263.33		98				
						28		<a href="#">PE71S6101</a>	\$912.92		99				
	L/S, D, NT		12			<a href="#">PE71S6098</a>		\$561.09	1						
			28			<a href="#">PE71S6099</a>		\$582.97	2						
	Transfer			F/I, TTL, D, NT	60	0.5		12	<a href="#">PE71S6112</a>		\$1,095.82	3			
								28	<a href="#">PE71S6113</a>		\$1,065.59	4			
				F/NT				12	<a href="#">PE71S6110</a>		\$757.10	5			
								28	<a href="#">PE71S6111</a>		\$805.42	6			
				L/I, TTL, S, D, NT				12	<a href="#">PE71S6116</a>		\$1,265.59	7			
								28	<a href="#">PE71S6117</a>		\$1,406.99	8			
L/S, D, NT		12		<a href="#">PE71S6114</a>			\$1,078.90	9							
		28		<a href="#">PE71S6115</a>			\$1,038.40	10							
40 GHz	SPDT	2.92mm Female	F/I, TTL, D, NT	50	0.8	12	10	<a href="#">PE71S6104</a>	\$2,918.17	See Web for Volume Pricing	11				
						28		<a href="#">PE71S6105</a>	\$2,715.01		12				
			F/NT			12		<a href="#">PE71S6102</a>	\$2,089.95		13				
						28		<a href="#">PE71S6103</a>	\$2,089.95		14				
			L/I, TTL, S, D, NT			55		12	<a href="#">PE71S6108</a>		\$3,666.43	15			
			28	<a href="#">PE71S6109</a>			\$3,923.09	16							
	SP4T			L/S, D, NT		50	0.9	12	5		<a href="#">PE71S6106</a>	\$3,086.54	17		
								28			<a href="#">PE71S6107</a>	\$2,970.68	18		
				L/I, TTL, S, D, NT				50			1	12	<a href="#">PE71S6141</a>	\$6,390.95	19
												28	<a href="#">PE71S6140</a>	\$6,916.87	20
L/I, TTL, S, D, T		12		<a href="#">PE71S6319</a>	\$7,960.88					21					
	28	<a href="#">PE71S6320</a>	\$7,960.88	22											
40 GHz		L/S, D, RS, T			28	3	<a href="#">PE71S6318</a>	\$7,224.53	23						
40 GHz		L/S, D, T			12		<a href="#">PE71S6317</a>	\$7,224.53	24						



1M Life Cycles



**Features:**  
 A: Absorptive  
 AR: Auto Reset  
 F: Failsafe  
 D: Diode  
 GR: Global Reset  
 H: Hot Switches  
 I: Indicators  
 L: Latching  
 NO: Normally Open  
 NT: Non-Terminated  
 P: Pulse  
 R: Latching Reflective  
 RS: Reset  
 S: Self Cut Off  
 T: Terminated  
 TTL: TTL Logic

Max Frequency (GHz)	Switch Type	Connector Type	Features	Min Isolation (dB)	Max IL (dB)	Voltage (V)	RF Power (W CW)	Model No	1	2-4	5-9	10+	ROW				
40 GHz	SP4T	2.92mm Female	L/S, RS, D, NT	50	0.9	12	3	PE71S6138	\$5,783.10	\$5,551.78	\$5,320.45	\$5,089.13	25				
								PE71S6139	\$5,783.10	\$5,551.78	\$5,320.45	\$5,089.13	26				
								PE71S6136	\$4,421.33	\$4,244.48	\$4,067.62	\$3,890.77	27				
								PE71S6137	\$4,274.56	\$4,103.58	\$3,932.60	\$3,761.61	28				
			SP6T	2.92mm Female	NO/NT	50	0.9	12	3	PE71S6134	\$2,952.35	\$2,834.26	\$2,716.16	\$2,598.07	29		
										PE71S6135	\$3,067.49	\$2,944.79	\$2,822.09	\$2,699.39	30		
										PE71S6148	\$7,120.35	\$6,835.54	\$6,550.72	\$6,265.91	31		
										PE71S6149	\$7,120.35	\$6,835.54	\$6,550.72	\$6,265.91	32		
					Transfer	2.92mm Female	L/S, I, RS, T	60	1	12	5	PE71S6321	\$8,012.98	\$7,692.46	\$7,371.94	\$7,051.42	33
												PE71S6322	\$8,012.98	\$7,692.46	\$7,371.94	\$7,051.42	34
												PE71S6146	\$6,460.40	\$6,201.98	\$5,943.57	\$5,685.15	35
												PE71S6147	\$6,712.36	\$6,443.87	\$6,175.37	\$5,906.88	36
	L/S, RS, D, NT	50					0.9	12	1	5	PE71S6323	\$8,770.18	\$8,419.37	\$8,068.57	\$7,717.76	37	
											PE71S6324	\$6,133.92	\$5,919.23	\$5,704.55	\$5,520.53	38	
											PE71S6144	\$6,985.71	\$6,706.28	\$6,426.85	\$6,147.42	39	
											PE71S6145	\$5,105.80	\$4,901.57	\$4,697.34	\$4,493.10	40	
	NO/NT	60	0.9	12	1	5	PE71S6142	\$3,369.15	\$3,234.38	\$3,099.62	\$2,964.85	41					
							PE71S6143	\$3,500.55	\$3,360.53	\$3,220.51	\$3,080.48	42					
							PE71S6120	\$3,781.78	\$3,630.51	\$3,479.24	\$3,327.97	43					
							PE71S6121	\$3,518.50	\$3,377.76	\$3,237.02	\$3,096.28	44					
	F/I, TTL, D, NT	50	0.9	12	1	5	PE71S6119	\$2,742.62	\$2,632.92	\$2,523.21	\$2,413.51	45					
							PE71S6124	\$5,016.09	\$4,815.45	\$4,614.80	\$4,414.16	46					
							PE71S6125	\$5,016.09	\$4,815.45	\$4,614.80	\$4,414.16	47					
							PE71S6122	\$3,243.26	\$3,113.53	\$2,983.80	\$2,854.07	48					
L/S, D, NT	50	0.9	12	1	5	PE71S6123	\$3,121.52	\$2,996.66	\$2,871.80	\$2,746.94	49						

2M Life Cycles



**Features:**  
 A: Absorptive  
 AR: Auto Reset  
 F: Failsafe  
 D: Diode  
 GR: Global Reset  
 H: Hot Switches  
 I: Indicators  
 L: Latching  
 NO: Normally Open  
 NT: Non-Terminated  
 P: Pulse  
 R: Latching Reflective  
 RS: Reset  
 S: Self Cut Off  
 T: Terminated  
 TTL: TTL Logic

Max Frequency (GHz)	Switch Type	Connector Type	Features	Min Isolation (dB)	Max IL (dB)	Voltage (V)	RF Power (W CW)	Model No	1 Pc. Price	See Web for Volume Pricing	ROW		
3 GHz	SPDT	SMA Female	L/NT	30		12		PE71S8001	\$465.44		50		
	SP4T							PE71S8002	\$586.99		51		
12 GHz	SPDT	N Female	F/NT	70	0.5	12	200	PE71S6348	\$696.76	See Web for Volume Pricing	52		
								PE71S6398	\$420.10		53		
								PE71S6397	\$420.10		54		
	Transfer		F/TTL, NT	60	0.7	28	120	PE71S6385	\$1,028.38		55		
								PE71S6403	\$752.80		56		
								PE71S6386	\$1,138.81		57		
12.4 GHz	SP6T	N Female	L/I, RS, NT	60	0.5	12	200	PE71S6072	\$3,571.79	58			
	SP12T	SMA Female	L/S, AR, I, D, T					0.6	28	120	PE71S6073	\$3,278.99	59
18 GHz	SPDT	SMA Female	F/I, NT	65	0.35	12	60				PE71S6351	\$336.81	61
								F/NT	PE71S6347	\$266.90	62		
									PE71S6392	\$267.30	63		
			F/T						60	0.5	100	PE71S6391	\$267.30
								PE71S6060				\$1,125.62	65
								PE71S6354				\$1,140.79	66

See Our Website For Current Pricing & Real-Time Stock Availability!

Switches



Technical Support  
 +1 (949) 261-1920



Same-Day Shipping,  
 Even Custom Cable Assemblies

**2M Life Cycles**



**Features:**  
 A: Absorptive  
 AR: Auto Reset  
 F: Failsafe  
 D: Diode  
 GR: Global Reset  
 H: Hot Switches  
 I: Indicators  
 L: Latching  
 NO: Normally Open  
 NT: Non-Terminated  
 P: Pulse  
 Latching  
 R: Reflective  
 RS: Reset  
 S: Self Cut Off  
 T: Terminated  
 TTL: TTL Logic

Max Frequency (GHz)	Switch Type	Connector Type	Features	Min Isolation (dB)	Max IL (dB)	Voltage (V)	RF Power (W CW)	Model No	1 Pc. Price	See Web for Volume Pricing	ROW	
18 GHz	SPDT	SMA Female	F/T	65	0.35	28	60	<a href="#">PE71S6355</a>	\$1,185.28	See Web for Volume Pricing	67	
								<a href="#">PE71S6404</a>	\$1,051.46		68	
			F/TTL, NT	60	0.5	28	100	<a href="#">PE71S6350</a>	\$408.60		69	
			L/I, S, T					<a href="#">PE71S6062</a>	\$1,461.80		70	
			L/I, T					<a href="#">PE71S6061</a>	\$1,287.01		71	
	L/TTL, T		<a href="#">PE71S6063</a>	\$1,408.27	72							
	SP4T		SMA Female	NO/NT	80	0.4	12	60	<a href="#">PE71S6363</a>		\$1,127.30	73
									<a href="#">PE71S6408</a>		\$805.70	74
				NO/T	<a href="#">PE71S6368</a>	\$2,347.11	75					
					<a href="#">PE71S6369</a>	\$2,438.65	76					
	NO/NT	<a href="#">PE71S6373</a>		\$1,252.15	77							
		<a href="#">PE71S6409</a>		\$1,024.73	78							
	NO/T	<a href="#">PE71S6380</a>		\$2,855.50	79							
		<a href="#">PE71S6381</a>		\$2,855.50	80							
	NO/TTL, NT	<a href="#">PE71S6374</a>	\$1,379.76	81								
		<a href="#">PE71S6375</a>	\$1,379.76	82								
	SP8T	SMA Female	L/I, RS, T	60	0.6	28	100	<a href="#">PE71S6080</a>	\$6,745.06		83	
								L/S, AR, I, D, T	<a href="#">PE71S6081</a>		\$6,565.37	84
	NO/NT		<a href="#">PE71S6384</a>	\$2,233.13	85							
			<a href="#">PE71S6076</a>	\$4,035.49	86							
SP10T	<a href="#">PE71S6083</a>		\$8,176.95	87								
	SP12T		<a href="#">PE71S6388</a>	\$766.44	88							
Transfer			SMA Female	F/NT	60	0.5	12	60	<a href="#">PE71S6389</a>	\$766.44	89	
	24								90	<a href="#">PE71S6400</a>	\$661.14	90
										<a href="#">PE71S6410</a>	\$2,950.95	91
20 GHz	SP10T		SMA Female	NO/NT	70	0.7	28	60	<a href="#">PE71S6356</a>	\$1,218.73	92	
26.5 GHz	SPDT	SMA Female	F/T	50	0.6	12	50	<a href="#">PE71S6357</a>	\$1,218.73	93		
								<a href="#">PE71S6370</a>	\$2,753.07	94		
	SP4T		NO/T	70	0.7	28	40	<a href="#">PE71S6371</a>	\$2,649.73	95		
								<a href="#">PE71S6079</a>	\$4,395.95	96		
	SP6T		L/S, RS, D, T	50	70	12	50	<a href="#">PE71S6382</a>	\$2,986.00	97		
								<a href="#">PE71S6383</a>	\$2,986.00	98		
40 GHz	SPDT	2.92mm Female	L/I, TTL, S, T	50	0.8	10	10	<a href="#">PE71S6064</a>	\$2,781.83	99		
								<a href="#">PE71S6089</a>	\$3,054.81	1		
	SP6T		L/I, RS, T	45	1.1	28	5	<a href="#">PE71S6084</a>	\$4,969.96	2		
								<a href="#">PE71S6078</a>	\$2,977.38	3		
50 GHz	SPDT	2.4mm Female	F/NT	60	0.3	28	80	<a href="#">PE71S6329</a>	\$1,438.18	4		
								<a href="#">PE71S6330</a>	\$1,438.18	5		

**2.5M Life Cycles**



**Features:**  
 A: Absorptive  
 AR: Auto Reset  
 F: Failsafe  
 D: Diode  
 GR: Global Reset  
 H: Hot Switches  
 I: Indicators  
 L: Latching  
 NO: Normally Open  
 NT: Non-Terminated  
 P: Pulse  
 Latching  
 R: Reflective  
 RS: Reset  
 S: Self Cut Off  
 T: Terminated  
 TTL: TTL Logic

Max Frequency (GHz)	Switch Type	Connector Type	Features	Min Isolation (dB)	Max IL (dB)	Voltage (V)	RF Power (W CW)	Model No	1 Pc. Price	See Web for Volume Pricing	ROW
12.4 GHz	Transfer	N Female	F/I, NT	60	0.5	28	200	<a href="#">PE71S6070</a>	\$1,010.51	See Web for Volume Pricing	6
18 GHz	Transfer	SMA Female	F/NT	60	0.5	12	100	<a href="#">PE71S6066</a>	\$878.70		7
								<a href="#">PE71S6065</a>	\$878.70		8
								<a href="#">PE71S6069</a>	\$1,343.93		9
			L/I, NT								

2.5M Life Cycles



**Features:**  
 A: Absorptive  
 AR: Auto Reset  
 F: Failsafe  
 D: Diode  
 GR: Global Reset  
 H: Hot Switches  
 I: Indicators  
 L: Latching  
 NO: Normally Open  
 NT: Non-Terminated  
 P: Pulse  
 R: Reflective  
 RS: Reset  
 S: Self Cut Off  
 T: Terminated  
 TTL: TTL Logic

Max Frequency (GHz)	Switch Type	Connector Type	Features	Min Isolation (dB)	Max IL (dB)	Voltage (V)	RF Power (W CW)	Model No	1	2-4	5-9	10+	ROW
18 GHz	Transfer	SMA Female	L/I, S, NT	60	0.5	28	100	PE71S6067	\$1,085.64	\$1,042.21	\$998.79	\$955.36	10
			L/I, TTL, S, NT					PE71S6068	\$1,243.60	\$1,193.86	\$1,144.11	\$1,094.37	11
40 GHz	Transfer	2.92mm Female	L/I, S, NT	50	0.8	28	10	PE71S6071	\$1,834.86	\$1,761.47	\$1,688.07	\$1,614.68	12

5M Life Cycles



**Features:**  
 A: Absorptive  
 AR: Auto Reset  
 F: Failsafe  
 D: Diode  
 GR: Global Reset  
 H: Hot Switches  
 I: Indicators  
 L: Latching  
 NO: Normally Open  
 NT: Non-Terminated  
 P: Pulse  
 R: Reflective  
 RS: Reset  
 S: Self Cut Off  
 T: Terminated  
 TTL: TTL Logic

Max Frequency (GHz)	Switch Type	Connector Type	Features	Min Isolation (dB)	Max IL (dB)	Voltage (V)	RF Power (W CW)	Model No	1 Pc. Price	See Web for Volume Pricing	ROW
12 GHz	SPDT	N Female	L/I, NT	70	0.5	28	200	PE71S6399	\$832.05	See Web for Volume Pricing	13
			L/NT					PE71S6349	\$754.60		14
	Transfer	SMA Female	L/NT	60	0.7	12	75	PE71S6387	\$1,029.64		15
								L/S, I, NT	PE71S6390		\$798.91
18 GHz	SPDT	SMA Female	L/I, NT	65	0.35	12	60	PE71S6353	\$333.18	17	
			L/I, T					PE71S6396	\$508.29	18	
			L/I, TTL, T					PE71S6395	\$423.80	19	
			L/NT					PE71S6406	\$1,071.29	20	
			L/S, I, NT					PE71S6407	\$1,223.25	21	
			L/T					PE71S6352	\$301.31	22	
			L/T					PE71S6394	\$420.14	23	
			L/T					PE71S6393	\$572.91	24	
	DP3T	SMA Female	L/I, NT	80	0.4	28	100	PE71S6358	\$1,209.97	25	
			L/NT					PE71S6359	\$1,164.55	26	
			L/T					PE71S6405	\$1,400.51	27	
			L/T					PE71S6362	\$1,884.66	28	
	SP3T	SMA Female	L/T	60	0.5	28	100	PE71S6364	\$2,149.69	29	
			NO/NT					PE71S6365	\$2,149.69	30	
	SP4T	SMA Female	L/T	80	0.4	12	60	PE71S6366	\$2,753.07	31	
			NO/NT					PE71S6074	\$1,686.91	32	
L/NT			PE71S6077					\$2,864.74	33		
L/T			PE71S6372					\$2,392.63	34		
SP6T	SMA Female	L/NT	80	0.4	12	60	PE71S6376	\$2,966.86	35		
		L/T					PE71S6377	\$2,855.50	36		
		NO/NT					PE71S6075	\$2,010.17	37		
		L/T					PE71S6402	\$724.79	38		
Transfer	SMA Female	L/I, NT	60	0.5	28	60	PE71S6401	\$897.52	39		
		L/S, I, NT					PE71S6360	\$1,244.12	40		
		L/T					PE71S6361	\$1,244.12	41		
		L/T					PE71S6366	\$2,596.73	42		
26.5 GHz	SP4T	SMA Female	L/T	70	0.7	12	50	PE71S6367	\$2,753.07	43	
								PE71S6378	\$2,986.00	44	
	SP6T							PE71S6379	\$2,986.00	45	
								PE71S6334	\$6,819.82	46	
40 GHz	SP4T	2.92mm Female	L/I, S, RS, T 0.05	80	0.5	24	5	PE71S6342	\$7,229.06	47	
			L/I, S, TTL, RS, T 0.05					PE71S6332	\$7,274.49	48	
	SP6T		L/I, S, RS, T 0.05					0.9	PE71S6330	\$7,510.99	49
			L/I, S, TTL, RS, T 0.05						PE71S6340	\$7,510.99	50

See Our Website For Current Pricing & Real-Time Stock Availability!

Switches



Technical Support  
 +1 (949) 261-1920



Same-Day Shipping,  
 Even Custom Cable Assemblies

### 10M Life Cycles



**Features:**  
 A: Absorptive  
 AR: Auto Reset  
 F: Failsafe  
 D: Diode  
 GR: Global Reset  
 H: Hot Switches  
 I: Indicators  
 L: Latching  
 NO: Normally Open  
 NT: Non-Terminated  
 P: Pulse  
 Latching  
 R: Reflective  
 RS: Reset  
 S: Self Cut Off  
 T: Terminated  
 TTL: TTL Logic

Max Frequency (GHz)	Switch Type	Connector Type	Features	Min Isolation (dB)	Max IL (dB)	Voltage (V)	RF Power (W CW)	Model No	1 Pc. Price	See Web for Volume Pricing			ROW
6 GHz	SP6T	SMA Female	L/GR, NT	70	0.3	28	70	<a href="#">PE71S6086</a>	\$1,517.37	See Web for Volume Pricing			49
			NO/NT					<a href="#">PE71S6085</a>	\$1,358.04				50
18 GHz	SPDT	SMA Female	F/NT	60	0.35	28	100	<a href="#">PE71S6052</a>	\$315.41				51
			L/I, S, NT					<a href="#">PE71S6053</a>	\$315.41				52
								<a href="#">PE71S6055</a>	\$461.74				53
								<a href="#">PE71S6054</a>	\$486.04				54
20 GHz	SPDT	SMA Female	L/I, S, NT 0.03	65	0.5	24	1	<a href="#">PE71S6335</a>	\$1,430.68				55
			L/I, S, T 0.03					<a href="#">PE71S6337</a>	\$2,074.85				56
			L/I, S, TTL, NT 0.03					<a href="#">PE71S6336</a>	\$1,770.08				57
			L/I, S, TTL, T 0.03					<a href="#">PE71S6338</a>	\$2,305.99				58
	SP4T		L/I, S, RS, T 0.03	80	0.6	70	<a href="#">PE71S6333</a>	\$4,859.13	59				
			L/I, S, TTL, RS, T 0.03				<a href="#">PE71S6341</a>	\$5,150.68	60				
			L/I, S, RS, T 0.03				<a href="#">PE71S6331</a>	\$5,399.02	61				
			L/I, S, TTL, RS, T 0.03				<a href="#">PE71S6339</a>	\$5,722.95	62				
26.5 GHz	SP6T	SMA Female	L/GR, NT	55	0.6	28	40	<a href="#">PE71S6087</a>	\$2,319.45	63			
			NO/TTL, NT					<a href="#">PE71S6088</a>	\$2,405.12	64			
40 GHz	SPDT	2.92mm Female	F/I, NT	50	0.8	28	10	<a href="#">PE71S6056</a>	\$912.53	65			
			L/I, S, NT					<a href="#">PE71S6057</a>	\$912.53	66			

### Special Applications



Max Frequency (GHz)	Switch Type	Connector Type	Features	Min Isolation (dB)	Max IL (dB)	Voltage (V)	RF Power (W CW)	Model No	1 Pc. Price	See Web for Volume Pricing			ROW
1 GHz	A/B Coaxial	BNC Female		50	0.7	12	5	<a href="#">PE7100</a>	\$569.49	See Web for Volume Pricing			67
	A/B Coaxial 75 Ohm	N Female						<a href="#">PE7102</a>	\$436.68				68
								<a href="#">PE7103</a>	\$389.21				69

### SMT Packaged Electromechanical Switches



**Features:**  
 A: Absorptive  
 AR: Auto Reset  
 F: Failsafe  
 D: Diode  
 GR: Global Reset  
 H: Hot Switches  
 I: Indicators  
 L: Latching  
 NO: Normally Open  
 NT: Non-Terminated  
 P: Pulse  
 Latching  
 R: Reflective  
 RS: Reset  
 S: Self Cut Off  
 T: Terminated  
 TTL: TTL Logic

Max Frequency (GHz)	Switch Type	Connector Type	Features	Min Isolation (dB)	Max IL (dB)	Voltage (V)	RF Power (W CW)	Model No	1-9	10-24	25-49	50+	ROW
3 GHz	SPDT	SMT	F/H, Non-T	40	0.3	12	175	<a href="#">PE71S6345</a>	\$239.04	\$227.09	\$215.14	\$205.57	70
			L/H, Non-T					<a href="#">PE71S6346*</a>	\$239.04	\$227.09	\$215.14	\$205.57	71
8 GHz			F/H, Non-T	30	0.8	24	35	<a href="#">PE71S6092</a>	\$291.45	\$276.88	\$262.31	\$250.65	72
			L/H, Non-T					<a href="#">PE71S6093</a>	\$280.51	\$266.48	\$252.46	\$241.24	73

\*Available SMA Connectorized Application PWB Option. Model PE71S8001 PWB supports connectorized SPDT. Model PE71S8002 PWB supports Connectorized SP4T.

## Waveguide Electromechanical Relay Switches, See Page 340

## Manual Switches



Impedance	Connector	Gender	Number of Output Ports	Frequency Range (MHz.)	Maximum Power	Model No	1 Pc. Price	See Web for Volume Pricing		R O W
50 Ohm	N	Female to		DC - 1,300	500 Watt	<a href="#">PE7139</a>	\$241.54	See Web for Volume Pricing		74
	SMA			DC - 22,000	50 Watt	<a href="#">PE7140</a>	\$384.06			75
						<a href="#">PE7SM1000A</a>	\$830.16			76

## PIN Diode Switches

### SPST



Switch Design	Freq. (GHz.)	Typ Iso (dB)	Typ IL (dB)	Switch Time (ns)	Max Input Power (dB)	TTL Control	Conn. Type	Model No	1	2-4	5-9	10+	R O W	
Absorptive	10 MHz - 1	80	1.3	200	0.1	Solder Pin	SMA Female	<a href="#">PE71S6230</a>	\$1,678.09	\$1,610.97	\$1,543.84	\$1,476.72	77	
	50 MHz - 26.5	30	5	150	0.5		SMA Female	<a href="#">PE71S2008</a>	\$5,556.99	\$5,334.71	\$5,112.43	\$4,890.15	78	
	50 MHz - 40	25	7.5		1		2.92mm Female	<a href="#">PE71S2012</a>	\$5,905.02	\$5,668.82	\$5,432.62	\$5,196.42	79	
	50 MHz - 67		9.5	0.5	1.85mm Female		<a href="#">PE71S2024</a>	\$7,468.02	\$7,169.30	\$6,870.58	\$6,571.86	80		
	500 MHz - 18	55	3.5	100	0.1		SMA Female	<a href="#">PE71S6209</a>	\$2,746.31	\$2,636.46	\$2,526.61	\$2,416.75	81	
	500 MHz - 40		5.5				2.92mm Female	<a href="#">PE71S6214</a>	\$3,980.86	\$3,821.63	\$3,662.39	\$3,503.16	82	
	1 - 2	80	0.9	50	0.1		SMA Female	<a href="#">PE71S6231</a>	\$1,880.20	\$1,804.99	\$1,729.78	\$1,654.58	83	
	1 - 18	65	3					<a href="#">PE71S6236</a>	\$2,601.94	\$2,497.86	\$2,393.78	\$2,289.71	84	
	2 - 4	75	1.1	150	1		SMA Female	<a href="#">PE71S6232</a>	\$1,962.43	\$1,883.93	\$1,805.44	\$1,726.94	85	
	2 - 26.5	25	4.5					<a href="#">PE71S2016</a>	\$5,323.34	\$5,110.41	\$4,897.47	\$4,684.54	86	
	2 - 40	30	5	50	0.1		SMA Female	2.92mm Female	<a href="#">PE71S2020</a>	\$5,384.02	\$5,168.66	\$4,953.30	\$4,737.94	87
	4 - 8	75	1.8					<a href="#">PE71S6233</a>	\$2,241.06	\$2,151.42	\$2,061.78	\$1,972.13	88	
	8 - 12	70	2.8	150	0.1		SMA Female	<a href="#">PE71S6234</a>	\$2,327.67	\$2,234.56	\$2,141.46	\$2,048.35	89	
	12 - 18	65						<a href="#">PE71S6235</a>	\$2,399.86	\$2,303.87	\$2,207.87	\$2,111.88	90	
	Reflective	10 MHz - 1	80	1	200		0.1	Solder Pin	SMA Female	<a href="#">PE71S6258</a>	\$1,605.91	\$1,541.67	\$1,477.44	\$1,413.20
50 MHz - 26.5		20	5	150	1	SMA Female	<a href="#">PE71S2007</a>		\$4,793.20	\$4,601.47	\$4,409.74	\$4,218.02	92	
50 MHz - 40		25	6.5			0.5	2.92mm Female		<a href="#">PE71S2011</a>	\$5,140.19	\$4,934.58	\$4,728.97	\$4,523.37	93
50 MHz - 67		20	8.5	100	0.1	1.85mm Female	<a href="#">PE71S2023</a>		\$6,339.53	\$6,085.95	\$5,832.37	\$5,578.79	94	
500 MHz - 18		55	3			SMA Female	<a href="#">PE71S6220</a>		\$2,573.74	\$2,470.79	\$2,367.84	\$2,264.89	95	
500 MHz - 40			5	2.92mm Female	<a href="#">PE71S6225</a>	\$3,004.43	\$2,884.25		\$2,764.08	\$2,643.90	96			
1 - 2		80	0.75	50	0.1	SMA Female	<a href="#">PE71S6259</a>		\$1,740.14	\$1,670.53	\$1,600.93	\$1,531.32	97	
1 - 18		65	2.5				<a href="#">PE71S6264</a>		\$2,529.78	\$2,428.59	\$2,327.40	\$2,226.21	98	
2 - 4		75	0.85	150	1	SMA Female	<a href="#">PE71S6260</a>		\$1,892.98	\$1,817.26	\$1,741.54	\$1,665.82	99	
2 - 26.5		20	4.5				<a href="#">PE71S2015</a>		\$4,511.36	\$4,330.91	\$4,150.45	\$3,970.00	1	
2 - 40			4	50	0.1	2.92mm Female	<a href="#">PE71S2019</a>		\$4,689.00	\$4,501.44	\$4,313.88	\$4,126.32	2	
4 - 8		75	1.5			SMA Female	<a href="#">PE71S6261</a>		\$2,087.47	\$2,003.97	\$1,920.47	\$1,836.97	3	
8 - 12		70	1.8	150	0.1	SMA Female	<a href="#">PE71S6262</a>		\$2,170.83	\$2,084.00	\$1,997.16	\$1,910.33	4	
12 - 18		65	2.5				<a href="#">PE71S6263</a>		\$2,240.30	\$2,150.69	\$2,061.08	\$1,971.46	5	

### SPDT



Switch Design	Freq. (GHz.)	Typ Iso (dB)	Typ IL (dB)	Switch Time (ns)	Max Input Power (dB)	TTL Control	Conn. Type	Model No	1	2-4	5-9	10+	R O W
Absorptive	5 MHz - 2.15	70	2.5	100,000	0.1	D-Sub	F Female	<a href="#">PE71S2043</a>	\$1,332.23	\$1,278.94	\$1,225.65	\$1,172.36	6



Technical Support  
+1 (949) 261-1920



Same-Day Shipping,  
Even Custom  
Cable Assemblies

SPDT



See Our Website For Current Pricing & Real-Time Stock Availability!

Switch Design	Freq. (GHz.)	Typ Iso (dB)	Typ IL (dB)	Switch Time (ns)	Max Input Power (dB)	TTL Control	Conn. Type	Model No	1 Pc. Price	See Web for Volume Pricing	ROW
Absorptive	5 MHz - 3	80	3.5	10,000	1	D-Sub	SMA Female	<a href="#">PE71S2036</a>	\$1,137.48	See Web for Volume Pricing	7
	10 MHz - 1		1.3	200	0.1	Solder Pin		<a href="#">PE71S6237</a>	\$1,952.35		8
	20 MHz - 4.3		3	10,000	1	D-Sub		<a href="#">PE71S2035</a>	\$1,137.48		9
	70 MHz - 26.5	55	5	100	0.5	SMA Female	<a href="#">PE71S2010</a>	\$8,682.99	10		
	70 MHz - 40		7			2.92mm Female	<a href="#">PE71S2014</a>	\$8,943.49	11		
	100 MHz - 67	40	10.5	50	0.1	SMA Female	1.85mm Female	<a href="#">PE71S2026</a>	Call		12
	500 MHz - 18	55	3.75			SMA Female	<a href="#">PE71S6210</a>	\$3,121.60	13		
	500 MHz - 40	60	6	100	0.1	Solder Pin	2.92mm Female	<a href="#">PE71S6215</a>	\$5,145.65		14
	800 MHz - 2.7	75	0.8			10,000	100	<a href="#">PE71S2041</a>	\$3,310.10		15
	1 - 18	65	3.5			0.1	0.1	SMA Female	<a href="#">PE71S6241</a>		\$2,868.99
	2 - 4	75	1.2	Pin	<a href="#">PE71S6208</a>				\$2,237.47		17
	2 - 26.5	60	4	0.5	0.5	SMA Female	<a href="#">PE71S2018</a>	\$7,999.44	18		
	2 - 40	55	5.5				2.92mm Female	<a href="#">PE71S2022</a>	\$8,336.00		19
	4 - 8	70	1.9	100	0.1	Solder Pin	SMA Female	<a href="#">PE71S6238</a>	\$2,508.13		20
	8 - 12		2.2					<a href="#">PE71S6239</a>	\$2,601.94		21
12 - 18	3.5		<a href="#">PE71S6240</a>					\$2,674.12	22		
10 MHz - 1	80	1.1	200	0.1	Solder Pin	SMA Female	<a href="#">PE71S6265</a>	\$1,809.62	23		
20 MHz - 500 MHz	50	0.5	40,000	150			<a href="#">PE71S2039</a>	\$3,176.39	24		
20 MHz - 1	40	0.75	10,000	25			<a href="#">PE71S2040</a>	\$3,176.39	25		
20 MHz - 2.5	50	0.75					<a href="#">PE71S2042</a>	\$2,896.21	26		
30 MHz - 530 MHz	60	1	200	5			<a href="#">PE71S2047</a>	\$711.44	27		
50 MHz - 1.5	30	3.5	100	0.5			<a href="#">PE71S2048</a>	\$711.44	28		
70 MHz - 26.5							SMA Female	<a href="#">PE71S2009</a>	\$6,773.00	29	
70 MHz - 40		5.5	2.92mm Female	2.92mm Female			<a href="#">PE71S2013</a>	\$7,119.99	30		
100 MHz - 500 MHz	55	0.5	40,000	250			Solder Pin	SMA Female	<a href="#">PE71S2038</a>	\$3,057.16	31
500 MHz - 18		3.2	100	<a href="#">PE71S6221</a>					\$2,934.98	32	
500 MHz - 40		5.5	50	0.1					2.92mm Female	<a href="#">PE71S6226</a>	\$3,247.58
1 - 18	65	2.5	100	1			SMA Female	<a href="#">PE71S6269</a>	\$2,796.81	34	
2 - 4	75	0.9						<a href="#">PE71S6219</a>	\$2,084.00	35	
2 - 26.5	30	3	100	0.5			SMA Female	<a href="#">PE71S2017</a>	\$7,480.79	36	
2 - 40		4						2.92mm Female	2.92mm Female	<a href="#">PE71S2021</a>	\$7,822.50
4 - 8	70	1.6	100	0.1	Solder Pin	SMA Female	<a href="#">PE71S6266</a>	\$2,344.50	38		
8 - 12		1.9					<a href="#">PE71S6267</a>	\$2,529.78	39		
12 - 18		2.5					<a href="#">PE71S6268</a>	\$2,504.27	40		

SP3T



Switch Design	Freq. (GHz.)	Typ Iso (dB)	Typ IL (dB)	Switch Time (ns)	Max Input Power (dB)	TTL Control	Conn. Type	Model No	1	2-4	5-9	10+	ROW	
Absorptive	10 MHz - 1	60	1.4	200	0.1	Solder Pin	SMA Female	<a href="#">PE71S6242</a>	\$2,136.10	\$2,050.66	\$1,965.21	\$1,879.77	41	
	500 MHz - 18	55	3.8	100				<a href="#">PE71S6211</a>	\$3,482.85	\$3,343.54	\$3,204.22	\$3,064.91	42	
	500 MHz - 40	60	6	50				2.92mm Female	<a href="#">PE71S6216</a>	\$5,527.60	\$5,306.50	\$5,085.39	\$4,864.29	43
	1 - 2		1.25	100				SMA Female	<a href="#">PE71S6243</a>	\$2,330.62	\$2,237.40	\$2,144.17	\$2,050.95	44

Switches

SP3T



Switch Design	Freq. (GHz.)	Typ Iso (dB)	Typ IL (dB)	Switch Time (ns)	Max Input Power (dB)	TTL Control	Conn. Type	Model No	1 Pc. Price	See Web for Volume Pricing	ROW
Absorptive	1 - 18	65	3.75	100	0.1	Solder Pin	SMA Female	<a href="#">PE71S6248</a>	\$3,004.43	See Web for Volume Pricing	45
	2 - 4	75	1.5					<a href="#">PE71S6244</a>	\$2,483.43		46
	4 - 8		2.5					<a href="#">PE71S6245</a>	\$2,782.38		47
	8 - 12	70	2.8					<a href="#">PE71S6246</a>	\$2,868.99		48
	12 - 18		3.75					<a href="#">PE71S6247</a>	\$2,830.78		49
Reflective	10 MHz - 1	60	1	200	0.1	Solder Pin	SMA Female	<a href="#">PE71S6270</a>	\$2,147.23	See Web for Volume Pricing	50
	500 MHz - 18	55	3.2					<a href="#">PE71S6222</a>	\$3,282.30		51
	500 MHz - 40		5.5					<a href="#">PE71S6227</a>	\$5,142.53		52
	1 - 2	60	1	100	0.5	Solder Pin	SMA Female	<a href="#">PE71S6271</a>	\$2,261.14		53
	1 - 18	65	3.3					<a href="#">PE7120D</a>	Call		54
			2.75					<a href="#">PE71S6276</a>	\$2,935.32		55
	2 - 4	75	1.2	100	0.1	Solder Pin	SMA Female	<a href="#">PE71S6272</a>	\$2,413.98		56
	4 - 8		2					<a href="#">PE71S6273</a>	\$2,608.47		57
	8 - 12	70	2.4	100	0.1	Solder Pin	SMA Female	<a href="#">PE71S6274</a>	\$2,796.81		58
	12 - 18		2.75					<a href="#">PE71S6275</a>	\$2,761.30		59

SP4T



Switch Design	Freq. (GHz.)	Typ Iso (dB)	Typ IL (dB)	Switch Time (ns)	Max Input Power (dB)	TTL Control	Conn. Type	Model No	1 Pc. Price	See Web for Volume Pricing	ROW
Absorptive	5 MHz - 2.15	70	2.5	100,000	0.1	D-Sub	F Female	<a href="#">PE71S2044</a>	\$1,823.06	See Web for Volume Pricing	60
	5 MHz - 3		3.5	10,000	1		SMA Female	<a href="#">PE71S2037</a>	\$1,560.01		61
	10 MHz - 1	60	1.5	200	0.1	Solder Pin	SMA Female	<a href="#">PE71S6249</a>	\$2,400.07		62
	500 MHz - 18	55	3.8	100				<a href="#">PE71S6212</a>	\$4,853.82		63
	500 MHz - 40	60	8	50			2.92mm Female	<a href="#">PE71S6217</a>	\$7,199.54		64
	1 - 2		1.2	<a href="#">PE71S6250</a>			\$2,587.63	65			
	1 - 18	70	3.75	100			<a href="#">PE71S6255</a>	\$3,268.42	66		
			1.5				<a href="#">PE71S6251</a>	\$2,747.42	67		
	2 - 4	75	2.5	50			<a href="#">PE71S6256</a>	Call	68		
	2 - 6		2.2	100			<a href="#">PE71S6252</a>	\$2,934.98	69		
	4 - 8	70	3	50			<a href="#">PE71S6257</a>	Call	70		
	6 - 12		2.6	100			<a href="#">PE71S6253</a>	\$3,143.26	71		
	8 - 12	70	3.75	100			<a href="#">PE71S6254</a>	\$3,094.74	72		
12 - 18			<a href="#">PE71S6277</a>				\$2,330.96	73			
Reflective	10 MHz - 1	60	1.2	200			0.1	Solder Pin	SMA Female	<a href="#">PE71S6223</a>	\$4,602.18
	500 MHz - 18	55	3.2	100	2.92mm Female	<a href="#">PE71S6228</a>				\$6,865.04	75
	500 MHz - 40		7.5	50	SMA Female	<a href="#">PE71S6278</a>			\$2,518.52	76	
	1 - 2	60	1	<a href="#">PE71S6283</a>		\$3,198.94			77		
	1 - 18	70	3	100	<a href="#">PE71S6279</a>	\$2,677.94			78		
			1.1		<a href="#">PE71S6284</a>	\$2,587.63			79		
	2 - 4	75	2	50	<a href="#">PE71S6280</a>	\$2,865.50			80		
	2 - 6		1.8	100	<a href="#">PE71S6285</a>	\$2,657.10			81		
	4 - 8	70	2.5	50	<a href="#">PE71S6281</a>	\$2,955.82			82		
	6 - 12		2.2	100	<a href="#">PE71S6282</a>	\$3,025.27			83		
	8 - 12	70	2.2	100							
	12 - 18		3								

See Our Website For Current Pricing & Real-Time Stock Availability!

Switches

**SP5T**



Switch Design	Freq. (GHz.)	Typ Iso (dB)	Typ IL (dB)	Switch Time (ns)	Max Input Power (dB)	TTL Control	Conn. Type	Model No	1	2-4	5-9	10+	ROW
Absorptive	100 MHz - 20	65	3.9	75	0.5	Solder Pin	SMA Female	<a href="#">PE71S2045</a>	\$4,289.58	\$4,118.00	\$3,946.41	\$3,774.83	84

**SP6T**



Switch Design	Freq. (GHz.)	Typ Iso (dB)	Typ IL (dB)	Switch Time (ns)	Max Input Power (dB)	TTL Control	Conn. Type	Model No	1 Pc. Price	See Web for Volume Pricing			ROW
Absorptive	100 MHz - 20	65	4.2	75	0.5	Solder Pin	SMA Female	<a href="#">PE71S2032</a>	Call				85
								<a href="#">PE71S2046</a>	\$4,761.94				86

**SP8T**



Switch Design	Freq. (GHz.)	Typ Iso (dB)	Typ IL (dB)	Switch Time (ns)	Max Input Power (dB)	TTL Control	Conn. Type	Model No	1	2-4	5-9	10+	ROW
Absorptive	100 MHz - 20	65	6	100	0.5	Solder Pin	SMA Female	<a href="#">PE71S2033</a>	\$7,957.39	\$7,639.09	\$7,320.80	\$7,002.50	87
	500 MHz - 18	55	4.5	50	0.1		2.92mm Female	<a href="#">PE71S6213</a>	\$7,740.86	\$7,431.23	\$7,121.59	\$6,811.96	88
	500 MHz - 40	50	10				2.92mm Female	<a href="#">PE71S6218</a>	\$9,725.69	\$9,336.66	\$8,947.63	\$8,558.61	89
Reflective	500 MHz - 18	55	4	100	0.1	Solder Pin	SMA Female	<a href="#">PE71S6224</a>	\$7,668.68	\$7,361.93	\$7,055.19	\$6,748.44	90
	500 MHz - 40	45	9	50			2.92mm Female	<a href="#">PE71S6229</a>	\$9,653.54	\$9,267.40	\$8,881.26	\$8,495.12	91

**SP12T**



Switch Design	Freq. (GHz.)	Typ Iso (dB)	Typ IL (dB)	Switch Time (ns)	Max Input Power (dB)	TTL Control	Conn. Type	Model No	1	2-4	5-9	10+	ROW
Absorptive	100 MHz - 20	65	6	100	0.5	Solder Pin	SMA Female	<a href="#">PE71S2034</a>	\$10,458.28	\$10,039.95	\$9,621.62	\$9,203.29	92

**Transfer**



Switch Design	Freq. (GHz.)	Typ Iso (dB)	Typ IL (dB)	Switch Time (ns)	Max Input Power (dB)	TTL Control	Conn. Type	Model No	1	2-4	5-9	10+	ROW
Absorptive	10 MHz - 1	80	1.3	100	2	Solder Pin	SMA Female	<a href="#">PE71S6286</a>	\$2,962.83	\$2,844.32	\$2,725.80	\$2,607.29	93
	1 - 2		1		1			<a href="#">PE71S6287</a>	\$3,121.60	\$2,996.74	\$2,871.87	\$2,747.01	94
	1 - 18	65	3.1		0.5			<a href="#">PE71S6292</a>	\$5,380.71	\$5,165.48	\$4,950.25	\$4,735.02	95
	2 - 4	75	1.2		1			<a href="#">PE71S6288</a>	\$3,323.70	\$3,190.75	\$3,057.80	\$2,924.86	96
	4 - 8		1.9		<a href="#">PE71S6289</a>			\$3,351.78	\$3,217.71	\$3,083.64	\$2,949.57	97	
	8 - 12	70	2.2		0.5			<a href="#">PE71S6290</a>	\$3,546.27	\$3,404.42	\$3,262.57	\$3,120.72	98
	12 - 18	65	3					<a href="#">PE71S6291</a>	\$4,046.43	\$3,884.57	\$3,722.72	\$3,560.86	99



### High Isolation PIN Diode Switches



Switch Design	Freq. (GHz.)	Typ Iso (dB)	Typ IL (dB)	Switch Time (ns)	TTL Control	Conn. Type	Model No	1	2-4	5-9	10+	ROW
SPST	0 - 20	65	6	8.5	Solder Pin	SMA Female	<a href="#">PE71S5001</a>	\$6,338.99	\$6,085.43	\$5,831.87	\$5,578.31	1
SPDT	0 - 18		3	12			<a href="#">PE71S5005</a>	\$6,297.94	\$6,046.02	\$5,794.10	\$5,542.19	2
	0 - 20	35	4	5	<a href="#">PE71S5000</a>		\$4,226.00	\$4,056.96	\$3,887.92	\$3,718.88	3	
	1 - 2	90	1	75	Solder Terminals		<a href="#">PE71S5002</a>	\$1,862.89	\$1,788.37	\$1,713.86	\$1,639.34	4
SP4T	0 - 20	38	3.8		Solder Pin		<a href="#">PE71S5006</a>	\$7,249.51	\$6,959.53	\$6,669.55	\$6,379.57	5
	2 - 6	80	1.8	35	Solder Terminals		<a href="#">PE71S5003</a>	\$2,435.94	\$2,338.50	\$2,241.06	\$2,143.63	6
	6 - 12	75	2.5	40			<a href="#">PE71S5004</a>	\$2,623.58	\$2,518.64	\$2,413.69	\$2,308.75	7

### High Isolation USB PIN Diode Switches



Switch Type	Frequency Band (GHz.)	Insertion Loss (dB)	Isolation (dB)	Switching Speed (µs)	Model No	1	2-4	5-9	10+	ROW
USB	0.5 - 18.0	6	60	6,000	<a href="#">PE71S3900</a>	\$3,391.37	\$3,255.72	\$3,120.06	\$2,984.41	8
	0.5 - 40.0				<a href="#">PE71S3901</a>	\$4,626.00	\$4,440.96	\$4,255.92	\$4,070.88	9

### GaN High Power Switches



Switch Design	Freq. (GHz.)	Typ Iso (dB)	Typ IL (dB)	Switch Time (ns)	Max Input Power (dB)	TTL Control	Conn. Type	Model No	1	2-4	5-9	10+	ROW
Reflective	DC - 6	33	0.9	100	46	Solder Pin	SMA	<a href="#">PE71S1100</a>	Call	Call	Call	Call	10
	DC - 12	32	1.5		44			<a href="#">PE71S1101</a>	Call	Call	Call	Call	11
	DC - 18	30	1.3	50	40			<a href="#">PE71S1102</a>	Call	Call	Call	Call	12
	0.5 - 6	43	1.2	100	50		N Type	<a href="#">PE71S1103</a>	Call	Call	Call	Call	13
	DC - 6	36	1.3		46		SMA	<a href="#">PE71S1104</a>	Call	Call	Call	Call	14
		33	0.9		44			<a href="#">PE71S1105</a>	Call	Call	Call	Call	15
	DC - 12	32	1.5		44			<a href="#">PE71S1106</a>	Call	Call	Call	Call	16
	DC - 18	30	1.3		50		40	<a href="#">PE71S1107</a>	Call	Call	Call	Call	17
	0.5 - 6	43	1.2		50		N Type	<a href="#">PE71S1108</a>	Call	Call	Call	Call	18
DC - 6	36	1.3	46	SMA	<a href="#">PE71S1109</a>	Call	Call	Call	Call	19			

# INDEX GUIDE TO SYNTHESIZERS AND OSCILLATORS

**SYNTHESIZERS..... 300**

**VOLTAGE CONTROLLED OSCILLATORS..... 301**

0.175" Ultra Small Commercial Surface Mount Packaged VCO.....	<a href="#">301</a>
0.5" Commercial Surface Mount Packaged VCO.....	<a href="#">301</a>
0.5" Commercial Surface Mount Packaged VCO w/ Integrated Buffer Amps.....	<a href="#">302</a>
0.5" Commercial Surface Mount Packaged VCO w/ Low Noise.....	<a href="#">302</a>
0.5" Commercial Surface Mount Packaged VCO w/ Modulation Input Port.....	<a href="#">302</a>
0.5" Hermetically Sealed MIL Grade Surface Mount Packaged VCO.....	<a href="#">302</a>
Connectorized Packaged VCO w/ Field Replaceable Connectors.....	<a href="#">303</a>
Hi Rel Hermetic Buffer Amp.....	<a href="#">303</a>
Commercial Standard.....	<a href="#">303</a>
Phase Locked Oscillators.....	<a href="#">304</a>
Phase Locked Crystal Oscillators.....	<a href="#">304</a>
Reference Oscillators.....	<a href="#">303</a>
TCXO Oscillators.....	<a href="#">304</a>

## SYNTHESIZERS



**Synthesizers & Oscillators**

Type	Freq. Band (MHz.)	Typ Ref. Freq. (MHz.)	Ph. Noise @100kHz Offset (dBc/Hz)	Output Power (dBm)	2nd Harmonic	Output Connector	Model No	1	2-4	5-9	10+	R O W
Serial, TTL	2,000 - 6,000	10	-94	14 to 17	-22	SMA Female	<a href="#">PE11S1002</a>	\$9,851.61	\$9,457.55	\$9,063.48	\$8,669.42	1
	5,500 - 10,500		-90	19 to 21	-20		<a href="#">PE11S1001</a>	\$10,235.82	\$9,826.39	\$9,416.95	\$9,007.52	2
USB	25 - 6,000	50	-86	-40 to 20	-25		<a href="#">PE11S3901</a>	\$6,237.48	\$5,987.98	\$5,738.48	\$5,488.98	3
	35 - 4,400		-103	-20 to 10	-30		<a href="#">PE11S3900</a>	\$1,809.55	\$1,737.17	\$1,664.79	\$1,592.40	4
	5,000 - 10,000		-72	-15 to 18	-25		<a href="#">PE11S3902</a>	\$7,374.55	\$7,079.57	\$6,784.59	\$6,489.60	5
	10,000 - 20,000		-80	-19 to 18	-15		<a href="#">PE11S3903</a>	\$7,847.90	\$7,573.22	\$7,298.55	\$7,063.11	6
	21,000 - 24,000		-88	-17 to 17	-22		<a href="#">PE11S3904</a>	\$5,936.43	\$5,698.97	\$5,461.52	\$5,224.06	7
	24,000 - 27,000		-75	14 to 17			<a href="#">PE11S3905</a>	\$6,292.62	\$6,040.92	\$5,789.21	\$5,537.51	8

# OSCILLATORS

## 0.175" Ultra Small Commercial Surface Mount Packaged VCO



Frequency (MHz.)	Tuning Voltage (Vdc)	Output Power Typ (dBm)	Supply Voltage (Vdc)	Phase Noise* (dBc/Hz)	2nd Harmonics Typ (dBc)	Pushing Typ (MHz.)	Pulling Typ (MHz.)	Model No	1-24	25-49	50-99	100+	ROW
125 - 250	DC - 18	8	5	-107	-10	0.5	3	<a href="#">PE2V000</a>	\$99.34	\$94.37	\$89.41	\$85.43	9
200 - 400	DC - 5	6	3	-95	-14	4	7	<a href="#">PE2V001</a>	\$103.21	\$98.05	\$92.89	\$88.76	10
250 - 500	DC - 20	8	5	-107	-8	1	3	<a href="#">PE2V002</a>	\$99.34	\$94.37	\$89.41	\$85.43	11
500 - 1,000	DC - 19	6	10	-97	-10	4	10	<a href="#">PE2V003</a>	\$103.21	\$98.05	\$92.89	\$88.76	12
800 - 1,600	DC - 18	11	5	-93	-17	4	20	<a href="#">PE2V004</a>	\$99.34	\$94.37	\$89.41	\$85.43	13
1,000 - 2,000	DC - 20	10	12	-90	-7	2	20	<a href="#">PE2V005</a>	\$99.34	\$94.37	\$89.41	\$85.43	14
2,000 - 2,750	DC - 10	11	11	-86	-17	6	22	<a href="#">PE2V006</a>	\$99.34	\$94.37	\$89.41	\$85.43	15
2,000 - 3,000	DC - 20	9	12	-87	-14	2	24	<a href="#">PE2V007</a>	\$103.21	\$98.05	\$92.89	\$88.76	16
3,120 - 3,920	DC - 11	8	10	-87	-22	10	22	<a href="#">PE2V008</a>	\$99.34	\$94.37	\$89.41	\$85.43	17
3,570 - 4,580	DC - 11.5	8	12	-83	-17	4	15	<a href="#">PE2V009</a>	\$103.21	\$98.05	\$92.89	\$88.76	18
4,400 - 5,000	DC - 4.5	1	5	-85	-17	5	18	<a href="#">PE2V010</a>	\$99.34	\$94.37	\$89.41	\$85.43	19
4,800 - 5,200	DC - 3	1	3.3	-80	-20	4	25	<a href="#">PE2V011</a>	\$99.34	\$94.37	\$89.41	\$85.43	20
4,800 - 5,700	DC - 11	8	12	-84	-20	2	20	<a href="#">PE2V012</a>	\$103.21	\$98.05	\$92.89	\$88.76	21
5,180 - 5,805	DC - 10	6	11	-83	-20	5	25	<a href="#">PE2V013</a>	\$103.21	\$98.05	\$92.89	\$88.76	22
5,400 - 5,900	DC - 10	8.5	11	-84	-25	5	25	<a href="#">PE2V014</a>	\$103.21	\$98.05	\$92.89	\$88.76	23
6,100 - 7,000	DC - 10	5.5	5	-76	-30	5	15	<a href="#">PE2V015</a>	\$103.21	\$98.05	\$92.89	\$88.76	24
7,390 - 8,060	DC - 9	4	5	-75	-22	10	40	<a href="#">PE2V016</a>	\$103.21	\$98.05	\$92.89	\$88.76	25
8,300 - 9,100	DC - 10	1	5	-73	-25	5	20	<a href="#">PE2V017</a>	\$103.21	\$98.05	\$92.89	\$88.76	26
9,000 - 10,000	DC - 11	7	12	-78	-30	15	50	<a href="#">PE2V018</a>	\$103.21	\$98.05	\$92.89	\$88.76	27
10,000 - 11,000	DC - 11	4	12	-72	-40	15	70	<a href="#">PE2V019</a>	\$103.21	\$98.05	\$92.89	\$88.76	28

## 0.5" Commercial Surface Mount Packaged VCO



Frequency (MHz.)	Tuning Voltage (Vdc)	Output Power Typ (dBm)	Supply Voltage (Vdc)	Phase Noise* (dBc/Hz)	2nd Harmonics Typ (dBc)	Pushing Typ (MHz.)	Pulling Typ (MHz.)	Model No	1-24	25-49	50-99	100+	ROW
10 - 20	DC - 20	10	15	-120	-11	0.02	0.05	<a href="#">PE1V1000</a>	\$99.17	\$94.21	\$89.25	\$85.29	29
18 - 30	DC - 12	12	12	-120	-13	0.03	0.07	<a href="#">PE1V1001</a>	\$99.17	\$94.21	\$89.25	\$85.29	30
25 - 50	DC - 15	11.5	15	-120	-12	0.05	0.03	<a href="#">PE1V1002</a>	\$95.45	\$90.68	\$85.91	\$82.09	31
30 - 60	DC - 15	11	15	-119	-14	0.05	0.05	<a href="#">PE1V1003</a>	\$95.45	\$90.68	\$85.91	\$82.09	32
40 - 80	DC - 20	12	15	-117	-14	0.05	0.05	<a href="#">PE1V1004</a>	\$99.17	\$94.21	\$89.25	\$85.29	33
40 - 100	DC - 20	11.5	15	-118	-14	0.2	0.1	<a href="#">PE1V1005</a>	\$95.45	\$90.68	\$85.91	\$82.09	34
50 - 100	DC - 20	12	15	-115	-12	0.05	0.1	<a href="#">PE1V1006</a>	\$95.45	\$90.68	\$85.91	\$82.09	35
60 - 120	DC - 18.5	11	15	-114	-20	0.2	0.1	<a href="#">PE1V1007</a>	\$95.45	\$90.68	\$85.91	\$82.09	36
75 - 150	DC - 18	11	15	-110	-20	0.2	0.4	<a href="#">PE1V1008</a>	\$95.45	\$90.68	\$85.91	\$82.09	37
100 - 200	DC - 18	11	15	-113	-12	0.2	0.1	<a href="#">PE1V1009</a>	\$95.45	\$90.68	\$85.91	\$82.09	38
150 - 300	DC - 20	11	15	-108	-14	1	2	<a href="#">PE1V1010</a>	\$99.17	\$94.21	\$89.25	\$85.29	39
200 - 400	DC - 20	11	15	-106	-14	0.4	0.2	<a href="#">PE1V1011</a>	\$99.17	\$94.21	\$89.25	\$85.29	40
300 - 400	DC - 9	11	15	-102	-18	0.6	0.5	<a href="#">PE1V1012</a>	\$99.17	\$94.21	\$89.25	\$85.29	41
400 - 600	DC - 15	11	15	-102	-15	1	1.5	<a href="#">PE1V1013</a>	\$95.45	\$90.68	\$85.91	\$82.09	42
400 - 800	DC - 9	8	5	-96	-14	3	1.3	<a href="#">PE1V1014</a>	\$95.45	\$90.68	\$85.91	\$82.09	43
500 - 900	DC - 11.5	12	12	-95	-14	1.5	1.5	<a href="#">PE1V1015</a>	\$95.45	\$90.68	\$85.91	\$82.09	44
600 - 1,000	DC - 20	12.5	15	-96	-15	0.8	0.7	<a href="#">PE1V1016</a>	\$99.17	\$94.21	\$89.25	\$85.29	45
800 - 1,200	DC - 20	11.5	15	-95	-12	0.8	2.5	<a href="#">PE1V1017</a>	\$99.17	\$94.21	\$89.25	\$85.29	46
1,200 - 1,800	DC - 20	11	15	-89	-12	0.5	3	<a href="#">PE1V1018</a>	\$99.17	\$94.21	\$89.25	\$85.29	47
1,350 - 1,650	DC - 18	10	15	-12	-12	1.5		<a href="#">PE1V1019</a>	\$95.45	\$90.68	\$85.91	\$82.09	48
1,500 - 2,100	DC - 18	10	15	-12	-12			<a href="#">PE1V1020</a>	\$95.45	\$90.68	\$85.91	\$82.09	49
1,500 - 2,500	DC - 16	10	15	-12	-12			<a href="#">PE1V1021</a>	\$99.17	\$94.21	\$89.25	\$85.29	50
2,000 - 2,750	DC - 10	7	11	-12	-12			<a href="#">PE1V1022</a>	\$99.17	\$94.21	\$89.25	\$85.29	51
2,570 - 3,300	DC - 10	5	11	-15	-15			<a href="#">PE1V1023</a>	\$99.17	\$94.21	\$89.25	\$85.29	52
3,000 - 3,500	DC - 10	10	11	-81	-16	2.5	12	<a href="#">PE1V1024</a>	\$95.45	\$90.68	\$85.91	\$82.09	53
3,120 - 3,870	DC - 10	5	11	-15	-15			<a href="#">PE1V1025</a>	\$99.17	\$94.21	\$89.25	\$85.29	54
4,000 - 5,000	DC - 15	8	15	-18	-18			<a href="#">PE1V1026</a>	\$99.17	\$94.21	\$89.25	\$85.29	55
4,260 - 5,000	DC - 10	7	11	-18	-18			<a href="#">PE1V1027</a>	\$95.45	\$90.68	\$85.91	\$82.09	56

\* Phase Noise measured at 10 KHz offset frequency



Technical Support  
+1 (949) 261-1920



Same-Day Shipping,  
Even Custom Cable Assemblies

See Our Website For Current Pricing & Real-Time Stock Availability!

Synthesizers & Oscillators

### 0.5" Commercial Surface Mount Packaged VCO w/ Integrated Buffer Amps



Frequency (MHz.)	Tuning Voltage (Vdc)	Output Power Typ (dBm)	Supply Voltage (Vdc)	Phase Noise* (dBc/Hz)	2nd Harmonics Typ (dBc)	Pushing Typ (MHz.)	Pulling Typ (MHz.)	Model No	1-24	25-49	50-99	100+	R O W
510 - 550	DC - 3.5	6.5	5	-106	-22	1.5	0.8	<a href="#">PE1V14000</a>	\$95.45	\$90.68	\$85.91	\$82.09	57
950 - 1,100	DC - 4.5	9	5	-104	-18	0.8	0.3	<a href="#">PE1V14001</a>	\$95.45	\$90.68	\$85.91	\$82.09	58
1,570 - 1,850	DC - 4.5	5	5	-101	-18	1.8	0.2	<a href="#">PE1V14002</a>	\$99.17	\$94.21	\$89.25	\$85.29	59
1,600 - 3,200	DC - 20	6	5	-89	-14	4	10	<a href="#">PE1V14003</a>	\$99.17	\$94.21	\$89.25	\$85.29	60
1,700 - 1,850	DC - 4.5	3.5	5	-100	-40	0.8	0.2	<a href="#">PE1V14004</a>	\$95.45	\$90.68	\$85.91	\$82.09	61
1,800 - 2,000	DC - 4.5	4.5	5	-100	-20	1.5	0.6	<a href="#">PE1V14005</a>	\$95.45	\$90.68	\$85.91	\$82.09	62
1,900 - 2,100	DC - 4.5	4.5	5	-102	-40	3	0.3	<a href="#">PE1V14006</a>	\$95.45	\$90.68	\$85.91	\$82.09	63
2,100 - 2,300	DC - 4.5	4.5	5	-101	-35	2.5	0.3	<a href="#">PE1V14007</a>	\$99.17	\$94.21	\$89.25	\$85.29	64
2,800 - 3,000	DC - 4.5	-2	5	-93	-25	2	0.8	<a href="#">PE1V14008</a>	\$95.45	\$90.68	\$85.91	\$82.09	65
4,130 - 4,350	DC - 8	7.5	8	-98	-30	4	6	<a href="#">PE1V14009</a>	\$95.45	\$90.68	\$85.91	\$82.09	66
4,770 - 5,010	DC - 7.5	5	8	-98	-20	4	4	<a href="#">PE1V14010</a>	\$95.45	\$90.68	\$85.91	\$82.09	67

### 0.5" Commercial Surface Mount Packaged VCO w/ Low Noise



Frequency (MHz.)	Tuning Voltage (Vdc)	Output Power Typ (dBm)	Supply Voltage (Vdc)	Phase Noise* (dBc/Hz)	2nd Harmonics Typ (dBc)	Pushing Typ (MHz.)	Pulling Typ (MHz.)	Model No	1-24	25-49	50-99	100+	R O W
305 - 425	DC - 19.5	8	5	-117	-40	1.5	4	<a href="#">PE1V15000</a>	\$95.45	\$90.68	\$85.91	\$82.09	68
850 - 900	DC - 4.5	1.5	5	-113	-45	0.3	0.2	<a href="#">PE1V15001</a>	\$99.17	\$94.21	\$89.25	\$85.29	69

### 0.5" Commercial Surface Mount Packaged VCO w/ Modulation Input Port



Frequency (MHz.)	Tuning Voltage (Vdc)	Output Power Typ (dBm)	Supply Voltage (Vdc)	Phase Noise* (dBc/Hz)	2nd Harmonics Typ (dBc)	Pushing Typ (MHz.)	Pulling Typ (MHz.)	Model No	1-9	10-24	25-49	50+	R O W
130 - 175	DC - 15	6.5	5	-125	-25	0.1	0.2	<a href="#">PE1V12000</a>	\$114.55	\$108.82	\$103.10	\$98.51	70
195 - 240	DC - 15	8.5	5	-125	-15	0.2	0.05	<a href="#">PE1V12001</a>	\$114.55	\$108.82	\$103.10	\$98.51	71
243 - 270	DC - 9.5	10	8	-120	-38	0.05	0.2	<a href="#">PE1V12002</a>	\$119.02	\$113.07	\$107.12	\$102.36	72
260 - 280	DC - 10	8	5	-123	-15	0.1	0.1	<a href="#">PE1V12003</a>	\$114.55	\$108.82	\$103.10	\$98.51	73
380 - 400	DC - 10	4.5	5	-124	-20	0.2	0.1	<a href="#">PE1V12004</a>	\$114.55	\$108.82	\$103.10	\$98.51	74
400 - 430	DC - 10	3.5	5	-123	-25	0.1	0.05	<a href="#">PE1V12005</a>	\$114.55	\$108.82	\$103.10	\$98.51	75
430 - 470	DC - 10	3.5	5	-122	-25	0.2	0.05	<a href="#">PE1V12006</a>	\$114.55	\$108.82	\$103.10	\$98.51	76
465 - 525	DC - 15	3.5	5	-122	-18	0.1	0.2	<a href="#">PE1V12007</a>	\$119.02	\$113.07	\$107.12	\$102.36	77
650 - 700	DC - 10	7.5	8	-121	-25	0.2	0.1	<a href="#">PE1V12008</a>	\$114.55	\$108.82	\$103.10	\$98.51	78

### 0.5" Hermetically Sealed MIL Grade Surface Mount Packaged VCO



Frequency (MHz.)	Tuning Voltage (Vdc)	Output Power Typ (dBm)	Supply Voltage (Vdc)	Phase Noise* (dBc/Hz)	2nd Harmonics Typ (dBc)	Pushing Typ (MHz.)	Pulling Typ (MHz.)	Model No	1-9	10-24	25-49	50+	R O W
10 - 20	DC - 20	10	15	-120	-11	0.02	0.05	<a href="#">PE1V13000</a>	\$426.88	\$405.54	\$384.19	\$367.12	79
18 - 30	DC - 12	12	12	-120	-13	0.03	0.07	<a href="#">PE1V13001</a>	\$426.88	\$405.54	\$384.19	\$367.12	80
25 - 50	0.5 - 20	11.5	15	-114	-10	0.1	0.1	<a href="#">PE1V13002</a>	\$426.88	\$405.54	\$384.19	\$367.12	81
30 - 60	DC - 15	11	15	-119	-14	0.05	0.05	<a href="#">PE1V13003</a>	\$426.88	\$405.54	\$384.19	\$367.12	82
40 - 80	DC - 20	12	15	-117	-14	0.05	0.05	<a href="#">PE1V13004</a>	\$426.88	\$405.54	\$384.19	\$367.12	83

\* Phase Noise measured at 10 KHz offset frequency

## 0.5" Hermetically Sealed MIL Grade Surface Mount Packaged VCO



Frequency (MHz.)	Tuning Voltage (Vdc)	Output Power Typ (dBm)	Supply Voltage (Vdc)	Phase Noise* (dBc/Hz)	2nd Harmonics Typ (dBc)	Pushing Typ (MHz.)	Pulling Typ (MHz.)	Model No	1-9	10-24	25-49	50+	ROW
40 - 100	DC - 20	11.5	15	-118	-14	0.2	0.1	<a href="#">PE1V13005</a>	\$426.88	\$405.54	\$384.19	\$367.12	84
50 - 100	DC - 20	12	15	-115	-12	0.05	0.1	<a href="#">PE1V13006</a>	\$426.88	\$405.54	\$384.19	\$367.12	85
60 - 120	DC - 18.5	11	15	-114	-20	0.2	0.1	<a href="#">PE1V13007</a>	\$426.88	\$405.54	\$384.19	\$367.12	86
75 - 150	DC - 18	11	15	-110	-20	0.2	0.4	<a href="#">PE1V13008</a>	\$426.88	\$405.54	\$384.19	\$367.12	87
100 - 200	DC - 18	11	15	-113	-12	0.2	0.1	<a href="#">PE1V13009</a>	\$426.88	\$405.54	\$384.19	\$367.12	88
150 - 300	DC - 20	11	15	-108	-14	1	2	<a href="#">PE1V13010</a>	\$426.88	\$405.54	\$384.19	\$367.12	89
200 - 400	DC - 20	11	15	-106	-14	0.4	0.2	<a href="#">PE1V13011</a>	\$443.53	\$421.35	\$399.18	\$381.44	90
400 - 800	DC - 9	8	5	-96	-14	3	1.3	<a href="#">PE1V13012</a>	\$426.88	\$405.54	\$384.19	\$367.12	91
1,200 - 1,800	DC - 20	11	15	-89	-12	0.5	3	<a href="#">PE1V13013</a>	\$426.88	\$405.54	\$384.19	\$367.12	92
3,000 - 3,500	DC - 10	10	11	-81	-16	2.5	12	<a href="#">PE1V13014</a>	\$443.53	\$421.35	\$399.18	\$381.44	93
3,700 - 4,350	DC - 7.5	4	8	-83	-25	6	15	<a href="#">PE1V13015</a>	\$443.53	\$421.35	\$399.18	\$381.44	94

## Connectorized Packaged VCO w/ Field Replaceable Connectors

### Commercial Standard



Frequency (MHz.)	Tuning Voltage (Vdc)	Output Power Typ (dBm)	Supply Voltage (Vdc)	Phase Noise* (dBc/Hz)	2nd Harmonics Typ (dBc)	Pushing Typ (MHz.)	Pulling Typ (MHz.)	Model No	1 Pc. Price	See Web for Volume Pricing			ROW
18 - 30	0.5 - 12	12	12	-120	-13	0.03	0.07	<a href="#">PE1V31000</a>	\$389.75	See Web for Volume Pricing			95
25 - 50	0.5 - 15	11.5	15	-120	-12	0.05	0.03	<a href="#">PE1V31001</a>	\$392.32				96
30 - 60	0.5 - 15	11	15	-119	-14	0.05	0.05	<a href="#">PE1V31002</a>	\$392.32				97
40 - 80	0.5 - 20	12	15	-117	-14	0.05	0.05	<a href="#">PE1V31003</a>	\$392.32				98
40 - 100	0.5 - 20	11.5	15	-118	-14	0.2	0.1	<a href="#">PE1V31004</a>	\$377.59				99
50 - 100	0.5 - 20	12	15	-115	-12	0.05	0.1	<a href="#">PE1V31005</a>	\$392.32				1
60 - 120	0.5 - 18.5	11	15	-114	-20	0.2	0.1	<a href="#">PE1V31006</a>	\$392.32				2
75 - 150	0.5 - 18	11	15	-110	-20	0.2	0.4	<a href="#">PE1V31007</a>	\$377.59				3
100 - 200	0.5 - 18	11	15	-113	-12	0.2	0.1	<a href="#">PE1V31008</a>	\$392.32				4
200 - 400	0.5 - 20	11	15	-106	-14	0.4	0.2	<a href="#">PE1V31009</a>	Call				5
400 - 800	0.5 - 13	12	10	-94	-20	0.6	0.7	<a href="#">PE1V31010</a>	Call				6
1,200 - 1,800	0.5 - 20	11	15	-89	-12	0.5	3	<a href="#">PE1V31011</a>	Call				7
3,000 - 3,500	0.5 - 10	10	11	-81	-16	2.5	12	<a href="#">PE1V31013</a>	\$392.32				8

### Hi-REL Hermetic Buffer Amp



Frequency (MHz.)	Tuning Voltage (Vdc)	Output Power Typ (dBm)	Supply Voltage (Vdc)	Phase Noise* (dBc/Hz)	2nd Harmonics Typ (dBc)	Pushing Typ (MHz.)	Pulling Typ (MHz.)	Model No	1	2-4	5-9	10+	ROW
4,000 - 8,000	DC - 18	20	12	-75	-10	0.2	1	<a href="#">PE1V34000</a>	\$4,887.05	\$4,716.00	\$4,544.96	\$4,398.35	9
5,000 - 10,000	DC - 20	20	12	-64	-15	0.2	1	<a href="#">PE1V34001</a>	\$5,638.74	\$5,413.19	\$5,187.64	\$4,962.09	10
8,000 - 12,500	DC - 13	21	12	-59	-20	0.2	2	<a href="#">PE1V34002</a>	\$6,281.25	\$6,030.00	\$5,778.75	\$5,527.50	11
38,400 - 43,200	DC - 13	13	5	-74	-30	40	0.01	<a href="#">PE1V34003</a>	\$9,825.30	\$9,432.29	\$9,039.28	\$8,646.26	12

## Reference Oscillators



Loop Type	Out Freq (MHz)	Ref. Type	Out Power Typ (dBm)	2nd Harmonics Typ (dBc)	Spurious Typ (dBc)	Ph Noise @100kHz Offset (dBc/Hz)	Package Type	Model No	1	2-4	5-9	10+	ROW
Free Running	10	Internal	7	-25		-150	Connectorized	<a href="#">PE19XR1003</a>	\$1,796.12	\$1,724.28	\$1,652.43	\$1,580.59	13

\* Phase Noise measured at 10 KHz offset frequency



Technical Support  
+1 (949) 261-1920



Same-Day Shipping,  
Even Custom  
Cable Assemblies

See Our Website For Current Pricing & Real-Time Stock Availability!

Synthesizers & Oscillators

## Reference Oscillators



Loop Type	Out Freq (MHz)	Ref. Type	Out Power Typ (dBm)	2nd Harmonics Typ (dBc)	Spurious Typ (dBc)	Ph Noise @100kHz Offset (dBc/Hz)	Package Type	Model No	1 Pc. Price	See Web for Volume Pricing	R O W
Free Running	10	Internal	7	-20		-145	Surface Mount	<a href="#">PE19XR1000</a>	\$382.06	See Web for Volume Pricing	14
	50			-25		Connectorized	<a href="#">PE19XR1004</a>	\$1,970.25	15		
				-20		Surface Mount	<a href="#">PE19XR1001</a>	\$401.11	16		
	100			-25		Connectorized	<a href="#">PE19XR1005</a>	\$2,163.70	17		
				-20		Surface Mount	<a href="#">PE19XR1002</a>	\$463.64	18		

## TCXO Oscillators

### CMOS



Output Freq. (GHz)	High Level Out Voltage (V min)	Low Level Out Voltage (V max)	Temp Stability (+/- ppm)	Ph Noise @10kHz Offset (dBc/Hz)	Dimensions (in)	Model No	1-4	5-9	10-24	25+	R O W
10	4.9	0.1	2.5	-145	1.25x1.25x 0.563	<a href="#">PE19XL6000</a>	\$711.44	\$675.87	\$640.30	\$611.84	19
20						<a href="#">PE19XL6001</a>	\$684.74	\$650.50	\$616.27	\$588.88	20

## Phase Locked Oscillators



Loop Type	Out Freq (MHz)	Ref. Type	Ref. Input Freq. (MHz.)	Out Power Typ (dBm)	2nd Harmonics Typ (dBc)	Spurious Typ (dBc)	Package Type	Model No	1 Pc. Price	See Web for Volume Pricing	R O W
Phase Locked	500	External	10	7	-35	-70	Connectorized	<a href="#">PE19XC7000</a>	\$1,563.98	See Web for Volume Pricing	21
							Surface Mount	<a href="#">PE19XP5004</a>	\$446.24		22
							Surface Mount	<a href="#">PE19XP5009</a>	\$446.24		23
							Connectorized	<a href="#">PE19XC7005</a>	\$1,505.27		24
							Connectorized	<a href="#">PE19XC7001</a>	\$1,563.98		25
							Surface Mount	<a href="#">PE19XP5005</a>	\$446.24		26
	1000				Surface Mount		<a href="#">PE19XP5010</a>	\$446.24	27		
					Connectorized		<a href="#">PE19XC7006</a>	\$1,505.27	28		
					Surface Mount		<a href="#">PE19XP5006</a>	\$625.53	29		
					Connectorized		<a href="#">PE19XC7002</a>	\$1,791.29	30		
					Surface Mount		<a href="#">PE19XP5011</a>	\$602.05	31		
					Connectorized		<a href="#">PE19XC7007</a>	\$1,791.29	32		
	2000				10		Connectorized	<a href="#">PE19XC7003</a>	\$2,052.42		33
							Surface Mount	<a href="#">PE19XP5007</a>	\$685.58		34
							Surface Mount	<a href="#">PE19XP5012</a>	\$659.84		35
							Connectorized	<a href="#">PE19XC7008</a>	\$1,975.38		36
							Connectorized	<a href="#">PE19XC7004</a>	\$2,264.03		37
							Surface Mount	<a href="#">PE19XP5008</a>	\$724.83		38
4000	10	Surface Mount	<a href="#">PE19XP5013</a>	\$724.83	39						
		Connectorized	<a href="#">PE19XC7009</a>	\$2,264.03	40						
		6000	100	-25				Surface Mount	<a href="#">PE19XP5008</a>	\$724.83	38
								Surface Mount	<a href="#">PE19XP5013</a>	\$724.83	39
								Connectorized	<a href="#">PE19XC7009</a>	\$2,264.03	40

## Phase Locked Crystal Oscillators



Loop Type	Out Freq (MHz)	Ref. Type	Ref. Input Freq. (MHz)	Out Power Typ (dBm)	2nd Harmonics Typ (dBc)	Spurious Typ (dBc)	Package Type	Model No	1-4	5-9	10-24	25+	R O W
Phase-Locked Crystal	50	External	10	+7	-20	-70	Surface Mount	<a href="#">PE19XP5000</a>	\$676.10	\$642.30	\$608.49	\$581.45	41

See Our Website For Current Pricing & Real-Time Stock Availability!

Synthesizers & Oscillators

### Phase Locked Crystal Oscillators



Loop Type	Out Freq (MHz)	Ref. Type	Ref. Input Freq. (MHz)	Out Power Typ (dBm)	2nd Harmonics Typ (dBc)	Spurious Typ (dBc)	Package Type	Model No	1 Pc. Price	See Web for Volume Pricing	ROW
Phase-Locked Crystal	50	External	10	+7	-20	-70	Connectorized	<a href="#">PE19XP5002</a>	\$2,420.04	See Web for Volume Pricing	42
	100						Surface Mount	<a href="#">PE19XP5001</a>	\$799.98		43
							Connectorized	<a href="#">PE19XP5003</a>	\$2,657.02		44

### TAPPERS

#### Equal Split



Frequency Range (MHz.)	Maximum Power	Directivity (dB)	Model No	1-9	10-24	25-49	50+	ROW
376-2,200	500 Watt		<a href="#">PE-T1006</a>	\$252.14	\$242.05	\$234.49	\$229.45	45
	700 Watt		<a href="#">PE-T1009</a>	\$210.17	\$199.66	\$189.15	\$180.75	46
380-2,500	500 Watt		<a href="#">PE-T1013</a>	\$274.54	\$263.56	\$255.32	\$249.83	47
			<a href="#">PE-T1000</a>	\$196.37	\$188.52	\$182.62	\$178.70	48
600-2,700	300 Watt		<a href="#">PE20DV1026</a>	\$208.40	\$197.98	\$187.56	\$179.22	49
			<a href="#">PE20DV1027</a>	\$260.50	\$247.48	\$234.45	\$224.03	50
			<a href="#">PE20DV1028</a>	\$236.20	\$224.39	\$212.58	\$203.13	51
			<a href="#">PE20DV1029</a>	\$295.92	\$281.12	\$266.33	\$254.49	52
			<a href="#">PE20DV1030</a>	\$257.04	\$244.19	\$231.34	\$221.05	53
			<a href="#">PE20DV1031</a>	\$312.60	\$296.97	\$281.34	\$268.84	54
			<a href="#">PE-T1012</a>	\$196.37	\$188.52	\$182.62	\$178.70	55
700-2,700	500 Watt		<a href="#">PE-T1003</a>	\$176.41	\$167.59	\$158.77	\$151.71	56
			<a href="#">PE-T1008</a>	\$240.93	\$228.88	\$216.84	\$207.20	57
			<a href="#">PE-T1010</a>	\$201.69	\$191.61	\$181.52	\$173.45	58
			<a href="#">PE-T1011</a>	\$263.34	\$250.17	\$237.01	\$226.47	59
			<a href="#">PE-T1002</a>	\$206.76	\$198.49	\$192.29	\$188.15	60

#### Unequal Split



Frequency Range (MHz.)	Maximum Power	Directivity (dB)	Model No	1-9	10-24	25-49	50+	ROW		
350-5,850	300 Watt	2	<a href="#">PE-T2009</a>	\$168.09	\$161.37	\$156.32	\$152.96	61		
			<a href="#">PE-T2013</a>	\$192.23	\$182.62	\$173.01	\$165.32	62		
			<a href="#">PETP1001</a>	\$243.13	\$230.97	\$218.82	\$209.09	63		
		3	<a href="#">PE-T2005</a>	\$168.09	\$161.37	\$156.32	\$152.96	64		
			<a href="#">PE-T2014</a>	\$151.36	\$143.79	\$136.22	\$130.17	65		
			<a href="#">PETP1002</a>	\$201.45	\$191.38	\$181.31	\$173.25	66		
		4	<a href="#">PETP1003</a>	\$243.13	\$230.97	\$218.82	\$209.09	67		
			<a href="#">PE-T2006</a>	\$174.65	\$167.66	\$162.42	\$158.93	68		
			<a href="#">PETP1004</a>	\$209.31	\$198.84	\$188.38	\$180.01	69		
		5	<a href="#">PETP1005</a>	\$243.13	\$230.97	\$218.82	\$209.09	70		
			<a href="#">PE-T2003</a>	\$174.65	\$167.66	\$162.42	\$158.93	71		
			<a href="#">PE-T2012</a>	\$151.36	\$143.79	\$136.22	\$130.17	72		
		7	<a href="#">PETP1006</a>	\$201.45	\$191.38	\$181.31	\$173.25	73		
			<a href="#">PETP1007</a>	\$243.13	\$230.97	\$218.82	\$209.09	74		
			<a href="#">PE-T2002</a>	\$168.09	\$161.37	\$156.32	\$152.96	75		
			<a href="#">PE-T2010</a>	\$151.36	\$143.79	\$136.22	\$130.17	76		
					<a href="#">PETP1008</a>	\$201.45	\$191.38	\$181.31	\$173.25	77
					<a href="#">PETP1009</a>	\$243.13	\$230.97	\$218.82	\$209.09	78



Technical Support  
+1 (949) 261-1920



Same-Day Shipping,  
Even Custom  
Cable Assemblies

# TAPPERS

## Unequal Split



Frequency Range (MHz.)	Maximum Power	Directivity (dB)	Model No	1-9	10-24	25-49	50+	ROW
350-5,850	300 Watt	9	<a href="#">PE-T2007</a>	\$254.32	\$241.60	\$228.89	\$218.72	79
			<a href="#">PETP1010</a>	\$201.45	\$191.38	\$181.31	\$173.25	80
		12	<a href="#">PE-T2020</a>	\$168.09	\$161.37	\$156.32	\$152.96	81
			<a href="#">PE-T2025</a>	\$151.36	\$143.79	\$136.22	\$130.17	82
		15	<a href="#">PE-T2022</a>	\$168.09	\$161.37	\$156.32	\$152.96	83
			<a href="#">PE-T2024</a>	\$145.68	\$138.40	\$131.11	\$125.28	84
		19	<a href="#">PE-T2008</a>	\$168.09	\$161.37	\$156.32	\$152.96	85
			<a href="#">PE-T2018</a>	\$151.36	\$143.79	\$136.22	\$130.17	86
		24	<a href="#">PE-T2019</a>	\$168.09	\$161.37	\$156.32	\$152.96	87
		30	<a href="#">PE-T2001</a>	\$168.09	\$161.37	\$156.32	\$152.96	88
			<a href="#">PE-T2015</a>	\$174.82	\$167.83	\$162.58	\$159.09	89
			<a href="#">PETP1012</a>	\$201.45	\$191.38	\$181.31	\$173.25	90
			<a href="#">PETP1013</a>	\$243.13	\$230.97	\$218.82	\$209.09	91
		39	<a href="#">PE-T2021</a>	\$168.09	\$161.37	\$156.32	\$152.96	92
		100	<a href="#">PE-T2000</a>	\$168.09	\$161.37	\$156.32	\$152.96	93
			<a href="#">PETP1014</a>	\$201.45	\$191.38	\$181.31	\$173.25	94
			<a href="#">PETP1015</a>	\$243.13	\$230.97	\$218.82	\$209.09	95
		1000	<a href="#">PE-T2004</a>	\$168.09	\$161.37	\$156.32	\$152.96	96
			<a href="#">PE-T2023</a>	\$236.45	\$224.63	\$212.81	\$203.35	97
			<a href="#">PETP1016</a>	\$201.45	\$191.38	\$181.31	\$173.25	98
<a href="#">PETP1017</a>	\$243.13		\$230.97	\$218.82	\$209.09	99		
380-6,000		100	<a href="#">PE-T2017</a>	\$213.99	\$203.29	\$192.59	\$184.03	1
698-2,700		4	<a href="#">PE-T2011</a>	\$151.36	\$143.79	\$136.22	\$130.17	2

## INDEX GUIDE TO TERMINATIONS AND MATCHING PADS

Terminations & Matching Pads

### TERMINATIONS AND MATCHING PADS.....307

#### MATCHING PADS.....311



Matching pads designed to mate with 50 ohm connectors on one end and 75 ohm connectors on the opposite end are available in a range of connector options.

Resistive Impedance Transformers.....311

#### TERMINATIONS.....307



RF Coaxial Terminations are available in a number of connector options and frequency ranges. Power ratings for these terminations range from 1/2 watt to 500 watts of continuous power. 50 ohm and 75 ohm options are available as well.

RF Load.....307 Feed-Thru Load.....310



# TERMINATIONS

## RF Load

50 Ohm



Max. Power (Watts)	Connector	Maximum Frequency.	Construction Material	VSWR Max.	Chain	Model No	1 Pc. Price	See Web for Volume Pricing	R O W	
<b>0.25 W</b>	Mini SMP Female	18 GHz	Gold Plated Beryllium	1.35:1	No	<a href="#">PE6184</a>	\$54.34	See Web for Volume Pricing	1	
		40 GHz	Copper	1.45:1	No	<a href="#">PE6182</a>	\$154.55		2	
<b>0.5 W</b>	2.92mm Male	40 GHz	Passivated Stainless Steel	1.2:1	Yes	<a href="#">PE6086</a>	\$396.98		3	
	2.92mm Female				No	<a href="#">PE6085</a>	\$289.94		4	
					Yes	<a href="#">PE6088</a>	\$434.50		5	
					No	<a href="#">PE6087</a>	\$434.92		6	
	7/16 DIN Male	1,000 MHz	Tri-Metal Plated Brass		No	<a href="#">PE6146</a>	\$129.65		7	
	Mini SMP Male	40 GHz	Gold Plated Beryllium	1.35:1	No	<a href="#">PE6163</a>	\$251.14		8	
	Mini SMP Female		Gold over Nickel Plated Beryllium		No	<a href="#">PE6162</a>	\$285.50		9	
	SMA Male	12.4 GHz	Passivated Stainless Steel	1.17:1	No	<a href="#">PE6002</a>	\$38.22		10	
	SMA Female				Yes	<a href="#">PE6070</a>	\$84.51		11	
	SMP Female	18 GHz	Gold Plated Beryllium	Copper	1.35:1	No	<a href="#">PE6183</a>		\$39.86	12
26.5 GHz		1.3:1			No	<a href="#">PE6181</a>	\$104.71		13	
<b>1 W</b>	1.85mm Male	65 GHz	Passivated Stainless Steel	1.6:1	Yes	<a href="#">PE6236</a>	\$587.19		14	
				No	<a href="#">PE6235</a>	\$516.33	15			
	2.4mm Male	50 GHz		1.45:1	Yes	<a href="#">PE6179</a>	\$552.75		16	
				No	<a href="#">PE6178</a>	\$499.60	17			
	2.92mm Male	40 GHz		1.25:1	Yes	<a href="#">PE6174</a>	\$298.07		18	
	2.92mm Female				No	<a href="#">PE6173</a>	\$237.67		19	
					No	<a href="#">PE6175</a>	\$332.10		20	
	BMA Plug	18 GHz			1.2:1		<a href="#">PE6TR1041</a>		\$170.34	21
	BMA Jack				1.3:1		<a href="#">PE6TR1042</a>		\$182.94	22
	Mini SMP Male				1.2:1		<a href="#">PE6TR1043</a>		\$55.94	23
Mini SMP Female						<a href="#">PE6TR1044</a>	\$55.94		24	
MMCX Male	6 GHz	Gold Plated Brass	1.35:1	No	<a href="#">PE6199</a>	\$28.42	25			
QMA Male	4 GHz			1.2:1	Yes	<a href="#">PE6TR1050</a>	\$15.70		26	
QN Male					Yes	<a href="#">PE6TR1051</a>	\$22.62		27	
					Yes	<a href="#">PE6TR1038</a>	\$50.53		28	
		Gold Plated Brass	1.1:1	No	<a href="#">PE6150</a>	\$6.76	29			
SMA Male	6 GHz	Tri-Metal Plated Brass		1.2:1	No	<a href="#">PE6241</a>	\$15.53		30	
					No	<a href="#">PE6TR1014</a>	\$8.62		31	
	8 GHz	Gold Plated Brass	1.15:1	No	<a href="#">PE6151</a>	\$43.51	32			
	18 GHz	Passivated Stainless Steel		1.25:1	Yes	<a href="#">PE6069</a>	\$61.65		33	
					Yes	<a href="#">PE6072</a>	\$91.89		34	
					No	<a href="#">PE6071</a>	\$56.27		35	
					Yes	<a href="#">PE6078</a>	\$114.73		36	
	26.5 GHz				No	<a href="#">PE6077</a>	\$105.98		37	
	SMA Female	18 GHz		1.25:1	No	<a href="#">PE6073</a>	\$88.33		38	
					Yes	<a href="#">PE6080</a>	\$165.35		39	
No					<a href="#">PE6079</a>	\$137.29	40			
SMB Plug	4 GHz	Gold Plated Brass		1.2:1	No	<a href="#">PE6TR1037</a>	\$26.05		41	
					No	<a href="#">PE6TR002</a>	\$11.54		42	
SMB Jack	10 GHz			1.3:1	No	<a href="#">PE6TR006</a>	\$21.42		43	
SMC Plug					1.35:1	No	<a href="#">PE6TR005</a>		\$9.22	44
SMC Jack					1.2:1		<a href="#">PE6TR1039</a>		\$55.94	45
									No	<a href="#">PE6161</a>
SMP Male	18 GHz	Gold over Nickel Plated Brass		1.2:1	No	<a href="#">PE6TR1040</a>	\$55.94		47	
SMP Female					No	<a href="#">PE6160</a>	\$166.20		48	
SSMC Plug	10 GHz	Gold Plated Brass	1.3:1	No	<a href="#">PE6243</a>	\$27.10	49			
2.4mm Male	50 GHz	Passivated Stainless Steel	1.45:1	No	<a href="#">PE6227</a>	\$324.17	50			
				No	<a href="#">PE6242</a>	\$533.20	51			
2.4mm Female	40 GHz		1.25:1	No	<a href="#">PE6180</a>	\$601.10	52			
2.92mm Male				Yes	<a href="#">PE6177</a>	\$402.89	53			
				No	<a href="#">PE6176</a>	\$355.22	54			
4.3-10 Male	6 GHz			1.15:1	Yes	<a href="#">PE6TR1045</a>	\$46.92		55	
					Yes	<a href="#">PE6TR1046</a>	\$45.16		56	
					Yes	<a href="#">PE6TR1047</a>	\$52.10		57	
					Yes	<a href="#">PE6TR1048</a>	\$52.10		58	
4.3-10 Female	3 GHz	Silver Plated Brass	1.15:1		<a href="#">PE6TR1049</a>	\$50.53	59			
7/16 DIN Male				Aluminum	1.1:1	<a href="#">PE6190</a>	\$66.34		60	
					<a href="#">PE6TR1013</a>	\$68.97	61			

Terminations & Matching Pads



Technical Support  
+1 (949) 261-1920



Same-Day Shipping,  
Even Custom Cable Assemblies

## RF Load

50 Ohm



Max. Power (Watts)	Connector	Maximum Frequency.	Construction Material	VSWR Max.	Chain	Model No	1 Pc. Price	See Web for Volume Pricing	ROW				
<b>2 W</b>	7/16 DIN Male	6 GHz	Tri-Metal Plated Brass	1.2:1	No	<a href="#">PE6196</a>	\$36.20	See Web for Volume Pricing	62				
	BNC Male	3 GHz		1.15:1	No	<a href="#">PE6TR007</a>	\$18.55		63				
		4 GHz		Nickel Plated Brass	1.1:1	Yes	<a href="#">PE6TR008</a>		\$20.16	64			
	N Male	6 GHz	Tri-Metal Plated Brass		1.2:1	No	<a href="#">PE6156</a>		\$27.44	65			
				1.1:1	No	<a href="#">PE6154</a>	\$38.02		66				
				1.2:1	Yes	<a href="#">PE6TR010</a>	\$23.97		67				
				1.2:1	No	<a href="#">PE6248</a>	\$27.89		68				
				1.2:1	No	<a href="#">PE6249</a>	\$20.55		69				
				1.2:1	No	<a href="#">PE6TR009</a>	\$14.85		70				
				1.2:1	No	<a href="#">PE6TR012</a>	\$23.21		71				
	N Female	6 GHz	Tri-Metal Plated Brass	1.2:1	No	<a href="#">PE6TR011</a>	\$21.99		72				
		18 GHz	Nickel Plated Brass	1.3:1	Yes	<a href="#">PE6075</a>	\$90.08		73				
	QMA Male	3 GHz			1.3:1	No	<a href="#">PE6009</a>		\$57.49	74			
		6 GHz			1.3:1	No	<a href="#">PE6076</a>		\$146.67	75			
	SMA Male	18 GHz	Passivated Stainless Steel	1.3:1	1.1:1	Yes	<a href="#">PE6032</a>		\$83.47	76			
					1.15:1	No	<a href="#">PE6TR1052</a>		\$16.31	77			
		26.5 GHz	Gold Plated Stainless Steel	1.35:1	1.15:1	No	<a href="#">PE6TR1036</a>		\$35.93	78			
					1.3:1	Yes	<a href="#">PE6082</a>		\$74.71	79			
					1.3:1	No	<a href="#">PE6081</a>		\$54.65	80			
					1.35:1	Yes	<a href="#">PE6TR675</a>		\$92.55	81			
		SMA Female	18 GHz	Passivated Stainless Steel	1.3:1	1.35:1	Yes		<a href="#">PE6TR677</a>	\$89.08	82		
						1.3:1	No		<a href="#">PE6TR671</a>	\$72.88	83		
						1.3:1	No		<a href="#">PE6TR673</a>	\$75.78	84		
		TNC Male	6 GHz	Tri-Metal Plated Brass	1.2:1	1.3:1	Yes		<a href="#">PE6084</a>	\$102.86	85		
1.3:1	No					<a href="#">PE6083</a>	\$74.62	86					
1.3:1	Yes					<a href="#">PE6TR014</a>	\$13.45	87					
18 GHz	Passivated Stainless Steel		1.25:1			No	<a href="#">PE6172</a>	\$19.40	88				
						No	<a href="#">PE6TR013</a>	\$15.77	89				
						No	<a href="#">PE6TR016</a>	\$13.79	90				
TNC Female	6 GHz	Tri-Metal Plated Brass	1.35:1	1.25:1	Yes	<a href="#">PE6090</a>	\$137.67	91					
				1.25:1	No	<a href="#">PE6089</a>	\$134.23	92					
	18 GHz			Passivated Stainless Steel	1.25:1	No	<a href="#">PE6229</a>	\$31.00	93				
						1.3:1	No	<a href="#">PE6TR015</a>	\$25.24	94			
<b>5 W</b>	2.92mm Male	40 GHz	Black Anodized Aluminum Heatsink	1.35:1	No	<a href="#">PE6TR028</a>	\$752.86	See Web for Volume Pricing	95				
									96				
	7/16 DIN Male	7 GHz	Tri-Metal Plated Brass	1.25:1	No	<a href="#">PE6100</a>	\$215.00		97				
									98				
	7/16 DIN Female	7 GHz	Tri-Metal Plated Brass	1.25:1	No	<a href="#">PE6139</a>	\$213.74		99				
									1				
	N Male	3 GHz	Aluminum	1.15:1						2			
										6 GHz	No	<a href="#">PE6187</a>	\$37.48
	N Female	18 GHz	Black Anodized Aluminum Heatsink	1.25:1						No	<a href="#">PE6186</a>	\$83.29	4
										No	<a href="#">PE6097</a>	\$144.75	5
										No	<a href="#">PE6098</a>	\$174.77	6
										No	<a href="#">PE6095</a>	\$122.84	7
										No	<a href="#">PE6096</a>	\$188.40	8
										No	<a href="#">PE6099</a>	\$178.29	9
No								<a href="#">PE6138</a>		\$206.76	10		
No								<a href="#">PE6105</a>		\$334.71	11		
<b>10 W</b>	7/16 DIN Male	7 GHz	Black Anodized Aluminum Heatsink	1.25:1	No	<a href="#">PE6105</a>	\$334.71	No	<a href="#">PE6141</a>	\$324.19	12		
								No	<a href="#">PE6034</a>	\$179.47	13		
	7/16 DIN Female	4 GHz	Black Anodized Aluminum Heatsink	1.15:1	No	<a href="#">PE6101</a>	\$240.45	No	<a href="#">PE6185</a>	\$99.65	14		
								No	<a href="#">PE6035</a>	\$261.18	15		
	BNC Male	6 GHz	Black Anodized Aluminum Heatsink	1.4:1	No	<a href="#">PE6102</a>	\$293.74	No	<a href="#">PE6036</a>	\$202.03	16		
								No	<a href="#">PE6103</a>	\$271.56	17		
BNC Female	6 GHz	Black Anodized Aluminum Heatsink	1.4:1	No	<a href="#">PE6104</a>	\$275.99	No	<a href="#">PE6104</a>	\$275.99	18			
							No	<a href="#">PE6140</a>	\$343.37	19			
<b>20 W</b>	N Male	2.7 GHz	Black Anodized Aluminum	1.33:1				No	<a href="#">PE6TR1022</a>	\$451.09	20		
								No	<a href="#">PE6TR1023</a>	\$469.14	21		
								No	<a href="#">PE6TR1021</a>	\$416.80	22		
								No	<a href="#">PE6TR1020</a>	\$433.06	23		
<b>25 W</b>	7/16 DIN Male	7 GHz	Black Anodized Aluminum Heatsink	1.25:1	No			No	<a href="#">PE6107</a>	\$444.80	24		
								8 GHz	1.6:1	<a href="#">PE6209</a>	\$329.28	25	

Terminations & Matching Pads

## RF Load

50 Ohm



Max. Power (Watts)	Connector	Maximum Frequency.	Construction Material	VSWR Max.	Chain	Model No	1 Pc. Price	See Web for Volume Pricing	Row		
<b>25 W</b>	7/16 DIN Female	8 GHz	Black Anodized Aluminum Heatsink	1.6:1		<a href="#">PE6210</a>	\$329.28	See Web for Volume Pricing	26		
	N Male	3 GHz		1.2:1	No	<a href="#">PE6228</a>	\$140.03		27		
		1.6:1		<a href="#">PE6205</a>	\$442.67	28					
	N Female	18 GHz		1.4:1	No	<a href="#">PE6106</a>	\$475.62		29		
				1.6:1	<a href="#">PE6206</a>	\$428.83	30				
				1.4:1	No	<a href="#">PE6037</a>	\$569.58		31		
				1.6:1	<a href="#">PE6203</a>	\$436.77	32				
				1.4:1	No	<a href="#">PE6204</a>	\$397.71		33		
1.6:1			<a href="#">PE6038</a>	\$515.35	34						
SMA Male	18 GHz	1.6:1	<a href="#">PE6207</a>	\$469.00	35						
		1.6:1	<a href="#">PE6208</a>	\$426.86	36						
<b>30 W</b>	SMA Female	4.2 GHz	Chem Film Plated Aluminum	1.25:1		<a href="#">PE6TR1000</a>	\$360.77		37		
	<b>40 W</b>	4.1/9.5 Mini DIN Male	2.7 GHz	Black Anodized Aluminum	1.15:1		<a href="#">PE6TR1026</a>		\$627.93	38	
4.3-10 Male		<a href="#">PE6TR1027</a>				\$640.93	39				
7/16 DIN Male		<a href="#">PE6TR1025</a>				\$486.26	40				
N Male		<a href="#">PE6TR1024</a>				\$486.26	41				
<b>50 W</b>	7/16 DIN Male	2.7 GHz	Aluminum	1.2:1	No	<a href="#">PE6238</a>	\$797.74		42		
		3 GHz	Black Anodized Aluminum Heatsink	1.15:1		<a href="#">PE6191</a>	\$363.16		43		
		4 GHz		1.25:1	No	<a href="#">PE6169</a>	\$488.77		44		
	8 GHz	1.6:1			<a href="#">PE6217</a>	\$506.20	45				
	7/16 DIN Female	3 GHz	Black Anodized Aluminum Heatsink	1.1:1			<a href="#">PE6189</a>		\$243.23	47	
							4 GHz		1.2:1	<a href="#">PE6188</a>	\$353.76
	N Male	18 GHz	Black Anodized Aluminum Heatsink	1.3:1	No		<a href="#">PE6TR029</a>		\$290.18	49	
							1.6:1		<a href="#">PE6213</a>	\$510.17	50
							1.45:1		<a href="#">PE6198</a>	\$443.58	51
							1.25:1		<a href="#">PE6233</a>	\$278.74	52
	N Female	3 GHz	Aluminum	1.1:1		<a href="#">PE6234</a>	\$193.35		53		
		18 GHz	Black Anodized Aluminum Heatsink	1.6:1		<a href="#">PE6214</a>	\$502.74		54		
	SMA Male	18 GHz	Black Anodized Aluminum Heatsink	1.45:1	No		<a href="#">PE6039</a>		\$614.99	55	
							1.6:1		<a href="#">PE6211</a>	\$517.62	56
	SMA Female	3 GHz	Nickel Plated Brass	1.25:1			<a href="#">PE6232</a>		\$209.59	57	
			Chem Film Plated Aluminum				<a href="#">PE6TR1001</a>		\$420.67	58	
18 GHz		Black Anodized Aluminum Heatsink	1.6:1	No		<a href="#">PE6212</a>	\$488.81		59		
						1.45:1	<a href="#">PE6040</a>		\$685.78	60	
TNC Male	18 GHz	Black Anodized Aluminum Heatsink	1.6:1			<a href="#">PE6215</a>	\$476.00		61		
TNC Female						<a href="#">PE6216</a>	\$516.52		62		
<b>60 W</b>	4.1/9.5 Mini DIN Male	2.7 GHz	Black Anodized Aluminum	1.15:1		<a href="#">PE6TR1030</a>	\$555.73	63			
	7/16 DIN Male					<a href="#">PE6TR1029</a>	\$671.24	64			
	N Male					<a href="#">PE6TR1028</a>	\$538.36	65			
	4.3-10 Male					<a href="#">PE6TR1035A</a>	\$902.19	66			
4.3-10 Female	2.7 GHz	Black Anodized Aluminum	1.2:1	No		<a href="#">PE6TR1035F</a>	\$902.19	67			
						<a href="#">PE6TR1033A</a>	\$781.50	68			
7/16 DIN Male	3 GHz	Black Anodized Aluminum Heatsink	1.2:1	No		<a href="#">PE6197</a>	\$358.68	69			
						8 GHz	<a href="#">PE6225</a>	Call	70		
	2 GHz	Black Anodized Aluminum Heatsink	1.35:1	No			<a href="#">PE6137</a>	\$900.09	71		
							2.7 GHz	<a href="#">PE6TR1033F</a>	\$781.50	72	
	8 GHz	Black Anodized Aluminum Heatsink	1.2:1	No			<a href="#">PE6239</a>	\$1,139.63	73		
							1.5:1	<a href="#">PE6226</a>	Call	74	
BNC Female	2 GHz	Black Anodized Aluminum Heatsink	1.2:1	No		<a href="#">PE6041</a>	\$884.78	75			
N Male	2.7 GHz	Black Anodized Aluminum Heatsink	1.5:1	No		<a href="#">PE6TR1032A</a>	\$781.50	76			
						4 GHz	<a href="#">PE6168</a>	\$546.41	77		
	8 GHz	Black Anodized Aluminum Heatsink	1.5:1				<a href="#">PE6221</a>	Call	78		
							2.7 GHz	<a href="#">PE6TR1032F</a>	\$811.98	79	
N Female	8 GHz	Black Anodized Aluminum Heatsink	1.5:1			<a href="#">PE6222</a>	\$689.91	80			
						<a href="#">PE6219</a>	\$726.32	81			
SMA Male	2 GHz	Black Anodized Aluminum Heatsink	1.3:1	No		<a href="#">PE6043</a>	\$934.06	82			
						6 GHz	<a href="#">PE6TR1002</a>	\$436.88	83		
SMA Female	8 GHz	Black Anodized Aluminum Heatsink	1.5:1			<a href="#">PE6220</a>	\$648.50	84			
						<a href="#">PE6223</a>	Call	85			
						<a href="#">PE6224</a>	Call	86			

See Web for Volume Pricing

Terminations & Matching Pads



Technical Support  
+1 (949) 261-1920



Same-Day Shipping,  
Even Custom Cable Assemblies

## RF Load

### 50 Ohm



Max. Power (Watts)	Connector	Maximum Frequency.	Construction Material	VSWR Max.	Chain	Model No	1 Pc. Price	See Web for Volume Pricing			ROW
<b>150 W</b>	SMA Female	3 GHz	Chem Film Plated Aluminum	1.3:1		<a href="#">PE6TR1003</a>	\$368.32				87
<b>200 W</b>	N Male	3 GHz	Black Anodized Aluminum Heatsink	1.25:1	No	<a href="#">PE6230</a>	\$589.92	See Web for Volume Pricing			88
	N Female					<a href="#">PE6231</a>	\$611.37				89
<b>300 W</b>	N Female	3 GHz	Chem Film Plated Aluminum	1.3:1		<a href="#">PE6TR1004</a>	\$546.17				
<b>500 W</b>	N Female	1.2 GHz	Chem Film Plated Aluminum	1.25:1		<a href="#">PE6TR1005</a>	\$539.68				91
<b>800 W</b>	N Female	500 MHz	Chem Film Plated Aluminum	1.5:1		<a href="#">PE6TR1006</a>	\$672.33				92

### 75 Ohm



Max. Power (Watts)	Connector	Maximum Frequency.	Construction Material	VSWR Max.	Chain	Model No	1-24	25-49	50-99	100+	ROW
<b>0.25 W</b>	F Male	3 GHz	Nickel Plated Zinc			<a href="#">PE6202-100PK</a>	\$72.44	\$68.82	\$65.20	\$62.30	93
						<a href="#">PE6202-25PK</a>	\$20.84	\$19.80	\$18.76	\$17.92	94
						No	<a href="#">PE6202</a>	\$1.18	\$1.12	\$1.06	\$1.01
<b>1 W</b>	BNC Male	1,000 MHz	Nickel Plated Brass		No	<a href="#">PE6165</a>	\$16.32	\$15.50	\$14.69	\$14.04	96
		2 GHz	Tri-Metal Plated Brass	1.35:1	No	<a href="#">PE6TR004</a>	\$62.72	\$59.58	\$56.45	\$53.94	97
<b>2 W</b>	BNC Female	2 GHz		1.15:1	No	<a href="#">PE6TR003</a>	\$62.72	\$59.58	\$56.45	\$53.94	98

## Feed-Thru Load

### 50 Ohm



Max. Power (Watts)	Connector Input	Connector Output	Maximum Frequency.	Construction Material	VSWR Max.	Chain	Model No	1 Pc. Price	See Web for Volume Pricing			ROW
<b>2 W</b>	BNC Male	BNC Female	1,000 MHz	Tri-Metal Plated Brass	1.3:1	No	<a href="#">PE6TR000</a>	\$50.00	See Web for Volume Pricing			99
	N Male	N Female		Nickel Plated Brass	1.65:1	No	<a href="#">PE6033</a>	\$146.67				1
	SMA Male	SMA Female		Passivated Stainless Steel	1.25:1	No	<a href="#">PE6026</a>	\$89.13				2

### 75 Ohm



Max. Power (Watts)	Connector Input	Connector Output	Maximum Frequency.	Construction Material	VSWR Max.	Chain	Model No	1-24	25-49	50-99	100+	ROW
<b>2 W</b>	BNC Male	BNC Female	1,000 MHz	Tri-Metal Plated Brass	1.3:1	No	<a href="#">PE6TR001</a>	\$35.47	\$33.70	\$31.92	\$30.50	3

Terminations & Matching Pads

## Resistive Impedance Transformers



Model No	Connector A 50 Ω	Connector B 75 Ω	Max. Frequency (MHz.)	VSWR Max.	Attenuation Loss (dB)	Accuracy (dB)	1 Pc. Price	See Web for Volume Pricing			R O W
<a href="#">PE7006</a>	BNC Male	BNC Female	2,000	1.2:1		±0.5	\$59.78				4
<a href="#">PE7007</a>	BNC Male	BNC Female	2,000	1.2:1	6		\$58.18				5
<a href="#">PE7067</a>	BNC Male	F Male	3,000	1.25:1	5.7	±0.5	\$119.78				6
<a href="#">PE7066</a>	BNC Male	F Female	3,000	1.25:1		±0.5	\$136.12				7
<a href="#">PE7068</a>	BNC Female	F Male	3,000	1.25:1		±0.5	\$129.83				8
<a href="#">PE7069</a>	BNC Female	F Female	3,000	1.25:1	5.7	±0.5	\$126.76				9
<a href="#">PE7072</a>	N Male	F Male	3,000	1.25:1		±0.5	\$139.79				10
<a href="#">PE70MP1002</a>	N Male	F Female	3,000				\$97.05				11
<a href="#">PE7071</a>	N Male	F Female	3,000	1.25:1		±0.5	\$105.16				12
<a href="#">PE7027</a>	N Male	N Female	2,000	1.2:1		±0.5	\$119.58				13
<a href="#">PE7070</a>	N Male	N Female	3,000	1.35:1		±0.5	\$119.97				14
<a href="#">PE7073</a>	N Female	F Male	3,000	1.25:1		±0.5	\$109.79				15
<a href="#">PE70MP1001</a>	N Female	F Female	3,000				\$159.00				16
<a href="#">PE7074</a>	N Female	F Female	3,000	1.25:1		±0.5	\$143.69				17
<a href="#">PE7028</a>	N Female	N Male	500	1.35:1		±0.5	\$26.97				18
<a href="#">PE7083</a>	N Female	N Male	3,000	1.35:1		±0.5	\$159.32				19
<a href="#">PE70MP1007</a>	SMA Male	F Male	3,000				\$97.05				20
<a href="#">PE7075</a>	SMA Male	F Male	3,000	1.25:1		±0.5	\$128.95				21
<a href="#">PE70MP1006</a>	SMA Male	F Female	3,000				\$97.05				22
<a href="#">PE7076</a>	SMA Male	F Female	3,000	1.25:1		±0.5	\$109.71				23
<a href="#">PE70MP1005</a>	SMA Female	F Male	3,000				\$97.05				24
<a href="#">PE7077</a>	SMA Female	F Male	3,000	1.25:1		±0.5	\$106.11				25
<a href="#">PE70MP1004</a>	SMA Female	F Female	3,000				\$97.05				26
<a href="#">PE7078</a>	SMA Female	F Female	3,000	1.25:1		±0.5	\$119.79				27
<a href="#">PE7079</a>	TNC Male	F Female	3,000	1.25:1	5.7	±0.5	\$159.00				28
<a href="#">PE7081</a>	TNC Female	F Male	3,000	1.25:1	5.7	±0.5	\$159.00				29
<a href="#">PE7082</a>	TNC Female	F Female	3,000	1.25:1	5.7	±0.5	\$109.00				30

See Web  
for  
Volume  
Pricing

Terminations &  
Matching Pads



Technical  
Support  
+1 (949) 261-1920



Same-Day Shipping,  
Even Custom  
Cable Assemblies

# INDEX GUIDE TO TEST AND MEASUREMENT PRODUCTS

<b>TEST AND MEASUREMENT PRODUCTS.....</b>	<b>312</b>
<b>1.0MM FLEXIBLE VNA 110 GHZ PRECISION CABLES.....</b>	<b><a href="#">316</a></b>
<b>26.5 GHZ &amp; 40 GHZ TEST CABLES.....</b>	<b><a href="#">318</a></b>
<b>4 - IN - 1 CALIBRATION KITS.....</b>	<b><a href="#">313</a></b>
<b>40 GHZ SKEW MATCHED CABLES.....</b>	<b><a href="#">314</a></b>
<b>50 GHZ &amp; 67 GHZ TEST CABLE ASSEMBLIES.....</b>	<b><a href="#">315</a></b>
<b>75 OHM TEST CABLE ASSEMBLIES.....</b>	<b><a href="#">318</a></b>
<b>CALIBRATION KITS.....</b>	<b><a href="#">312</a></b>
<b>COAXIAL RF PROBES &amp; PROBE POSITIONING HARDWARE.....</b>	<b><a href="#">313</a></b>
<b>HANDHELD RF ANALYZER RUGGED PHASE STABLE CABLE ASSEMBLIES.....</b>	<b><a href="#">314</a></b>
<b>PE-TC151 SERIES PHASE STABLE TEST CABLE ASSEMBLIES.....</b>	<b><a href="#">317</a></b>
<b>PE-TC195 SERIES PHASE STABLE TEST CABLE ASSEMBLIES.....</b>	<b><a href="#">317</a></b>
<b>RUGGEDIZED VNA CABLE ASSEMBLIES.....</b>	<b><a href="#">315</a></b>
<b>SEMI-RIGID PIGTAIL TEST PROBES.....</b>	<b><a href="#">318</a></b>
<b>VNA TEST CABLES.....</b>	<b><a href="#">313</a></b>

## CALIBRATION KITS

### Bench Type Calibration Kits



Connector Series	Impedance (Ohms)	Frequency Range (GHz)	Cal Type	Model No	1 Pc. Price	See Web for Volume Pricing	R O W
2.4mm	50	DC to 50	SOL	<a href="#">PE5CK1015</a>	\$8,300.00	See Web for Volume Pricing	1
			SOLT	<a href="#">PE5CK1016</a>	\$11,178.70		2
2.92mm		DC to 40	SOL	<a href="#">PE5CK1017</a>	\$11,987.00		3
			SOLT	<a href="#">PE5CK1018</a>	\$13,953.50		4
3.5mm		DC to 8.5	SOLT	<a href="#">PE5CK1001</a>	\$3,475.58		5
			SOL	<a href="#">PE5500-KIT</a>	Call		6
			SOLT	<a href="#">PE5CK1000</a>	\$5,246.17		7
			SOL	<a href="#">PE5CK1019</a>	\$6,792.00		8
			SOLT	<a href="#">PE5CK1020</a>	\$7,406.70		9
7/16 DIN		DC to 7.5	SOL	<a href="#">PE5CK1021</a>	\$8,864.50		10
			SOLT	<a href="#">PE5CK1022</a>	\$13,091.00		11
7mm		DC to 18	SOL	<a href="#">PE5CK1023</a>	\$6,122.57		12
BNC				<a href="#">PE5CK1024</a>	\$7,362.32		13
N		DC to 18	SOLT	<a href="#">PE5501-KIT</a>	Call		14
				<a href="#">PE5CK1025</a>	\$5,070.79		15
	<a href="#">PE5CK1026</a>			\$6,955.00	16		
F	75	DC to 3	SOLT	<a href="#">PE5CK1002</a>	\$2,598.33	17	
				<a href="#">PE70MP5000</a>	\$4,496.55	18	

Test & Measurement

## VNA TEST CABLES

For Use With Interchangeable Connectors



Impedance (Ohms)	Connector Series	Frequency Range (GHz)	Type	Model No	1	2-4	5-9	10+	ROW
50	3.5mm NMD Female	DC - 26.5	Cable for Interchangeable Connectors	<a href="#">PE310-KIT</a>	\$5,119.68	\$4,940.49	\$4,761.30	\$4,607.71	19

## Interchangeable Connectors



Impedance (Ohms)	Connector Series	Frequency Range (GHz)	Gender	Polarity	Type	Model No	1 Pc. Price	See Web for Volume Pricing	ROW
50	3.5mm	DC - 26.5	Female	Standard	Connector	<a href="#">PE44488</a>	Call	See Web for Volume Pricing	20
			Male			<a href="#">PE44487</a>	\$686.25		21
	N	DC - 18	Female			<a href="#">PE44486</a>	Call		22
			Male			<a href="#">PE44485</a>	Call		23

## 4 - IN - 1 CALIBRATION KITS

### Product Features

- Lightweight Portable 4-in-1 Package
- Precision 3.5mm Connectors
- Gold Plated Short Open Load Thru
- Supports 26.5 GHz SOLT Calibration
- Calibration Coefficients on Data Sheet



Connector 1	Impedance (Ohms)	Freq. Range (GHz)	Weight (lbs.)	Model No	1	2-4	5-9	10+	ROW
3.5mm Female Short Open Load Thru	50	DC to 26.5	2.752	<a href="#">PE5CK1012</a>	\$3,890.73	\$3,735.10	\$3,579.47	\$3,423.84	24
3.5mm Male Short Open Load Thru				<a href="#">PE5CK1013</a>	\$3,941.49	\$3,783.83	\$3,626.17	\$3,468.51	25

## COAXIAL RF PROBES & PROBE POSITIONING HARDWARE

### Product Features

PCB RF Probe Positioner (PE5TL1000): \$1,202.93

- RF PCB probe positioner holds coaxial probes
- Magnetic mounting plate
- On-Off positioner switch
- Articulated joints
- Multi-axis positioner control

Coaxial RF Microwave GS and GSG Probe Series (PE2PB1000-PE2PB1003):

- Max. Operating Frequency of 20 GHz
- RF probe Return Loss better than 10 dB
- GS and GSG Probes Feature Gold Plated Contacts
- Compliant coaxial GSG (or GS) pogo pins



RF MICROWAVE PROBES													ROW	
Probe Tip Config.	Number of Ground	Pitch 1 (µm)	Pitch 2 (µm)	Connector 1	Imp. (Ω)	Freq. Max (GHz)	RL Max (dB)	IL Max (dB)	Model No	1-4	5-9	10-24	25+	ROW
GS	1	800		2.92mm Female	50	40	10	0.5	<a href="#">PE2PB1006</a>	\$843.90	\$801.71	\$759.51	\$725.75	26
				3.5mm Female					<a href="#">PE2PB1002</a>	\$603.18	\$573.02	\$542.86	\$518.73	27
	2	1500	2,500	2.92mm Female					<a href="#">PE2PB1007</a>	\$868.92	\$825.47	\$782.03	\$747.27	28
				3.5mm Female					<a href="#">PE2PB1003</a>	\$621.06	\$590.01	\$558.95	\$534.11	29
GSG	2	800		2.92mm Female	50	40	10	0.5	<a href="#">PE2PB1004</a>	\$906.62	\$861.29	\$815.96	\$779.69	30
				3.5mm Female					<a href="#">PE2PB1000</a>	\$647.87	\$615.48	\$583.08	\$557.17	31
	4	1500	2,500	2.92mm Female					<a href="#">PE2PB1005</a>	\$931.64	\$885.06	\$838.48	\$801.21	32
				3.5mm Female					<a href="#">PE2PB1001</a>	\$665.74	\$632.45	\$599.17	\$572.54	33

## 40 GHZ SKEW MATCHED CABLES



### Product Features

- 1 ps Delay match
- Excellent VSWR of 1.4:1
- 100% tested up to 40 GHz
- Extremely Flexible
- Polarity indicators on cable ends

Connector 1	Connector 2	Max Frequency (GHz)	Max VSWR	Typ Insertion Loss (dB/ft)	Model No	1	2-4	5-9	10+	ROW
2.92mm Male	2.92mm Male	40	1.4:1	1.4	<a href="#">PE3C4680-12</a>	\$1,152.59	\$1,106.49	\$1,060.38	\$1,014.28	34
				2.8	<a href="#">PE3C4680-24</a>	\$1,277.05	\$1,225.97	\$1,174.89	\$1,123.80	35
				5.6	<a href="#">PE3C4680-48</a>	\$1,525.96	\$1,464.92	\$1,403.88	\$1,342.84	36

## HANDHELD RF ANALYZER RUGGED PHASE STABLE CABLE ASSEMBLIES

### Product Features

- Designed for in-field measurements with handheld or portable analyzers
- Excellent VSWR as low as 1.2:1
- Excellent Phase Stability with Flexure as low as 1.5 degrees
- Rugged Armor provides 1200 p.s.i crush resistance plus torque resistance
- UV resistance jacket
- Each assembly is serialized and includes test data



Connector 1	Connector 2	Freq. Max (GHz)	Imp (Ohm)	VSWR	IL @fmax (dB/ft)	Phase Stability with Flexure (Degrees)	Length (in)	Model No	1 Pc. Price	See Web for Volume Pricing	ROW		
N Male	7/16 DIN Male	7	50	1.2:1	2.16	1.5	60.0	<a href="#">PE3C4000-60</a>	\$606.13	See Web for Volume Pricing	37		
	7/16 DIN Female				4.92		144.0	<a href="#">PE3C4000-144</a>	\$794.81		38		
		N Male			2.16		60.0	<a href="#">PE3C4001-60</a>	\$856.69		39		
	N Male Right Angle				4.92		144.0	<a href="#">PE3C4001-144</a>	\$1,068.06				
		N Female			9		2.52	60.0	<a href="#">PE3C4002-60</a>		\$494.77	40	
	5.74						144.0	<a href="#">PE3C4002-144</a>	\$729.86				
	2.52						60.0	<a href="#">PE3C4003-60</a>	\$760.79				
	5.74						144.0	<a href="#">PE3C4003-144</a>	\$1,047.86				
	N Male	18			1.3:1		2.0	2.52	60.0		<a href="#">PE3C4004-60</a>	\$494.77	41
								5.74	144.0		<a href="#">PE3C4004-144</a>	\$729.86	
								2.66	39.4		<a href="#">PE3C4005-100CM</a>	\$637.06	
								3.89	60.0		<a href="#">PE3C4006-100CM</a>	\$804.09	
	2.66	<a href="#">PE3C4007-100CM</a>			\$637.06								
	3.89	<a href="#">PE3C4008-60</a>			\$689.65								
	3.89	<a href="#">PE3C4009-60</a>			\$689.65								
	3.5mm Male	3.5mm Female			27		4.0	3.46	39.4		<a href="#">PE3C4010-60</a>	\$964.95	42
<a href="#">PE3C4011-60</a>			\$964.95										
<a href="#">PE3C4012-100CM</a>			\$872.15										
<a href="#">PE3C4013-100CM</a>			\$872.15										

Test & Measurement



## RUGGEDIZED VNA TEST CABLE ASSEMBLIES

See Our Website For Current Pricing & Real-Time Stock Availability!



### Product Features

- Rugged VNA test port extenders
- Torsion resistant connector heads
- Max phase variation +/- 2° with flexure to 18 GHz
- Max phase variation +/- 3° with flexure to 26.5 GHz
- Max phase variation +/- 5° with flexure to 40 GHz
- 5,000 mating cycles minimum
- 75,000 flexure cycles minimum
- Each cable is serialized and comes with RF test data
- SMA, Type-N, 2.92mm and 2.4mm configurations available

Pasternack's ruggedized VNA test cables are designed to provide customers with repeatable accurate VNA measurements. These test cables have excellent electrical properties including low insertion loss, low VSWR and phase stability of +/- 2° to 18 GHz with flexure. Torsion resistant connector heads are directly attached to stainless steel conduit style armoring providing a rugged design for up to 5,000 mating cycles with proper care. The cable armoring enhances amplitude and phase stability by preventing stress due to over bending while maintaining the flexibility required for testing in a lab environment. When used with the appropriate calibration kit these test cables effectively extend the test port of the VNA allowing for accurate measurements of devices that cannot be directly connected to a Network Analyzer test port.

Connector 1	Connector 2	Freq. Max (GHz)	Imp (Ohm)	VSWR	IL (dB/ft)	IL (dB/m)	Phase Stability with Flexure (Degrees)	Flex Cycles	Model No	1 Pc. Price	See Web for Volume Pricing	ROW				
2.4mm Male	2.4mm Female	40	50	1.38:1	0.83	2.72	5	---	<a href="#">PE3VNA4005-24</a>	\$2,114.23	See Web for Volume Pricing	51				
	2.4mm Male								<a href="#">PE3VNA4004-24</a>	\$1,972.35		52				
2.92mm Male	2.92mm Female	26.5							1.25:1	0.64		2.1	3	<a href="#">PE3VNA2606-24</a>	\$1,521.23	53
		40							1.38:1	0.83		2.72	5	<a href="#">PE3VNA4002-24</a>	\$1,987.98	54
	2.92mm Male	26.5							1.25:1	0.64		2.1	3	<a href="#">PE3VNA2605-24</a>	\$1,491.45	55
		40							1.38:1	0.83		2.72	5	<a href="#">PE3VNA4001-24</a>	\$1,925.46	56
3.5mm Male	3.5mm Female	26.5		1.3:1	0.64	2.1	3	<a href="#">PE3VNA2604-24</a>	\$1,491.45	57						
	3.5mm Male			<a href="#">PE3VNA2603-24</a>				\$1,461.69	58							
N Male	N Female	18		1.25:1	0.52	1.71	2	<a href="#">PE3VNA1804-24</a>	\$806.69	59						
	N Male							<a href="#">PE3VNA1803-24</a>	\$791.80	60						
SMA Male	SMA Female							<a href="#">PE3VNA1802-24</a>	\$791.80	61						
	SMA Male							<a href="#">PE3VNA1801-24</a>	\$776.91	62						

See Web for other lengths

## 50 AND 67 GHZ TEST CABLE ASSEMBLIES

### Product Features

- Highly flexible VNA test cables up to 50 and 67 GHz
- Max phase variation +/- 6° to 50 GHz and +/- 8° to 67 GHz with flexure
- VSWR of 1.3:1 to 50 GHz and 1.4:1 to 67 GHz
- Rated up to 5,000 mating cycles
- Up to 100,000 flex cycles
- Swept right angle connector options available
- Highly flexible stainless steel braided armoring
- Designed for accurate and repeatable measurements



Test & Measurement

Connector 1	Connector 2	Freq. Max (GHz)	Imp (Ohm)	VSWR	IL @fmax (dB/ft)	Phase Stability with Flexure (Degrees)	Flex Cycles	Model No	1	2-4	5-9	10+	ROW
2.4mm Male	2.4mm Male	50	50	1.300	3.7	6.00	100,000	<a href="#">PE3TC0500-24</a>	\$2,789.44	\$2,677.86	\$2,566.28	\$2,454.71	63
					7			<a href="#">PE3TC0500-48</a>	\$2,932.19	\$2,814.90	\$2,697.61	\$2,580.33	

Continued on Next Page



Technical Support  
+1 (949) 261-1920



Same-Day Shipping,  
Even Custom  
Cable Assemblies

## 50 AND 67 GHZ TEST CABLE ASSEMBLIES

See Our Website For Current Pricing & Real-Time Stock Availability!

### Product Features

- Highly flexible VNA test cables up to 50 and 67 GHz
- Max phase variation +/- 6° to 50 GHz and +/- 8° to 67 GHz with flexure
- VSWR of 1.3:1 to 50 GHz and 1.4:1 to 67 GHz
- Rated up to 5,000 mating cycles
- Up to 100,000 flex cycles
- Swept right angle connector options available
- Highly flexible stainless steel braided armoring
- Designed for accurate and repeatable measurements



Connector 1	Connector 2	Freq. Max (GHz)	Imp (Ohm)	VSWR	IL @fmax (dB/ft)	Phase Stability with Flexure (Degrees)	Flex Cycles	Model No	1	2-4	5-9	10+	ROW
2.4mm Male	2.4mm Female	50		1.300	3.7	6.00	100,000	<a href="#">PE3TC0600-24</a>	\$2,789.44	\$2,677.86	\$2,566.28	\$2,454.71	64
					7			<a href="#">PE3TC0600-48</a>	\$2,932.19	\$2,814.90	\$2,697.61	\$2,580.33	
	2.4mm Male Right Angle				3.7			<a href="#">PE3TC0700-24</a>	\$3,262.51	\$3,132.01	\$3,001.51	\$2,871.01	65
					7			<a href="#">PE3TC0700-48</a>	\$3,402.13	\$3,266.04	\$3,129.96	\$2,993.87	
1.85mm Male	1.85mm Male	67		1.400	4.3	8.00	100,000	<a href="#">PE3TC0800-24</a>	\$2,884.71	\$2,769.32	\$2,653.93	\$2,538.54	66
					8.2			<a href="#">PE3TC0800-48</a>	\$3,024.63	\$2,903.64	\$2,782.66	\$2,661.67	
	1.85mm Female				4.3			<a href="#">PE3TC0900-24</a>	\$2,884.71	\$2,769.32	\$2,653.93	\$2,538.54	67
					8.2			<a href="#">PE3TC0900-48</a>	\$3,024.63	\$2,903.64	\$2,782.66	\$2,661.67	
	1.85mm Male				4.3			<a href="#">PE3TC0800-500CM</a>	Call	Call	Call	Call	68
					8.2			<a href="#">PE3TC1000-24</a>	\$3,355.10	\$3,220.90	\$3,086.69	\$2,952.49	
	1.85mm Male Right Angle				4.3			<a href="#">PE3TC1000-48</a>	\$3,498.00	\$3,358.08	\$3,218.16	\$3,078.24	69
					8.2								

## 1.0MM FLEXIBLE VNA 110 GHZ PRECISION CABLES

### Product Features

- Operating to 110 GHz
- Lightweight, protective armoring
- Precision 1.0mm stainless steel connectors
- Non-conductive protective Nome® outer sleeve
- Easy assembly is serialized and includes test data



Connector 1	Connector 2	Freq. Max (GHz)	Imp (Ohm)	VSWR	IL @fmax (dB/ft)	Phase Stability with Flexure (Degrees)	Length (in)	Model No	1	2-4	5-9	10+	ROW
1.0mm Male	1.0mm Male	110	50	1.5	3.12	1.5	6.0	<a href="#">PE3TC1220-6</a>	\$5,878.91	\$5,643.75	\$5,408.60	\$5,173.44	70
					5.62		<a href="#">PE3TC1220-12</a>	\$7,867.15	\$7,552.46	\$7,237.78	\$6,923.09		
	1.0mm Female				3.12		<a href="#">PE3TC1221-6</a>	\$5,878.91	\$5,673.15	\$5,467.39	\$5,291.02	71	
					5.62		<a href="#">PE3TC1221-12</a>	\$6,136.39	\$5,921.62	\$5,706.84	\$5,522.75		

Test & Measurement

## PE-TC195 SERIES PHASE STABLE TEST CABLE ASSEMBLIES

### Product Features

- Phase and amplitude stability with flexure
- Small diameter, lighter weight and lower profile for high density test applications
- Phase change with flexure +/-2° to 18 GHz
- Excellent for multi-port test equipment
- Very flexible and durable cable with a min. bend radius of 1 inch
- Excellent VSWR and insertion loss
- Extra strain relief for extended connector body with booting to enhance stability and longevity
- Each serialized assembly comes with matching test data
- 5,000 mating cycles when properly mated
- In-Stock and ready to ship



See Our Website For Current Pricing & Real-Time Stock Availability!

Connector 1	Connector 2	Freq. Max (GHz)	Imp (Ohm)	VSWR	IL (dB/ft)	IL (dB/m)	Phase Stability with Flexure (Degrees)	Flex Cycles	Model No	1 Pc. Price	See Web for Volume Pricing	ROW
N Male	N Female	18	50	1.25:1	0.68	2.23	2	75,000	<a href="#">PE3TC0104-24</a>	\$383.91	See Web for Volume Pricing	72
	N Male								<a href="#">PE3TC0103-24</a>	\$340.60		73
SMA Male	SMA Female	27	2.06	6.76	3	<a href="#">PE3TC0105-24</a>	\$329.78	74				
		18				<a href="#">PE3TC0102-24</a>	\$356.84	75				
	SMA Male	27	0.68	2.23	2	<a href="#">PE3TC0202-24</a>	\$553.52	76				
		18				<a href="#">PE3TC0101-24</a>	\$313.54	77				
	27	2.06	6.76	3	<a href="#">PE3TC0201-24</a>	\$454.28	78					

See Web for other lengths

## PE-TC151 SERIES PHASE STABLE TEST CABLE ASSEMBLIES

### Product Features

- Phase and amplitude stability with flexure
- Small diameter, lighter weight and lower profile for high density test applications
- Phase change with flexure +/-5° to 18 GHz
- Excellent for multi-port test equipment
- Very flexible and durable cable with a min. bend radius of 0.75 inches
- Excellent VSWR and insertion loss
- Extra strain relief for extended connector body with booting to enhance stability and longevity
- Each serialized assembly comes with matching test data
- 5,000 mating cycles when properly mated
- In-Stock and ready to ship



Connector 1	Connector 2	Freq. Max (GHz)	Imp (Ohm)	VSWR	IL (dB/ft)	IL (dB/m)	Phase Stability with Flexure (Degrees)	Flex Cycles	Model No	1-9	10-24	25+	ROW
N Male	N Male	18	50	1.3:1	0.85	2.79	5	75,000	<a href="#">PE3TC0302-24</a>	\$278.24	\$264.33	\$250.42	79
									<a href="#">PE3TC0303-24</a>	\$269.58	\$256.10	\$242.62	80
SMA Male	SMA Male	27	2.06	6.76	3	<a href="#">PE3TC0301-24</a>	\$230.61	\$219.08	\$207.55	81			
		18				<a href="#">PE3TC0401-24</a>	\$390.84	\$371.30	\$351.76	82			

See Web for other lengths

Test & Measurement



Technical Support  
+1 (949) 261-1920



Same-Day Shipping,  
Even Custom  
Cable Assemblies

## 75 OHM TEST CABLE ASSEMBLIES



### Product Features

- Phase and amplitude stability with flexure
- Small diameter, lighter weight and lower profile for high density test applications
- Very flexible and durable cable with a min. bend radius of 0.75 inches
- Each serialized assembly comes with matching test data

Connector 1	Connector 2	Freq. Max (GHz)	Imp (Ohm)	VSWR	IL (dB/ft)	IL (dB/m)	Phase Stability with Flexure (Degrees)	Flex Cycles	Model No	1-9	10-24	25+	ROW
N Male	F Male	3	75	1.16:1	0.193	0.63	5	100,000	<a href="#">PE3CA1031-60cm</a>	\$262.32	\$249.20	\$236.09	83
	N Male								<a href="#">PE3CA1032-60cm</a>	\$297.94	\$283.04	\$268.15	84

See Web for other lengths

## SEMI-RIGID PIGTAIL TEST PROBES

### Product Features

- Operating to 6 GHz
- SMA Female connectors
- Excellent VSWR of 1.3:1
- Straight-cut and pre-stripped probe ends available

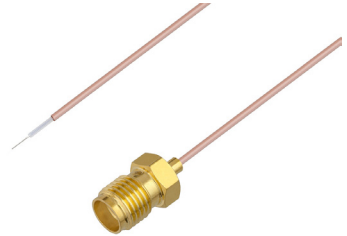

Connector 1	Cable	Lead	Freq. Max (GHz)	Imp (Ohm)	VSWR	IL @fmax (dB/ft)	Length (in)	Model No	1-24	25-49	50-99	100+	ROW
SMA Female	PE-020SR	Straight Cut Lead	6	50	1.35:1	0.43	3.0	<a href="#">PE3CA1107-3</a>	\$61.56	\$58.48	\$55.40	\$52.94	85
		Trimmed Lead						<a href="#">PE3CA1104-3</a>	\$95.25	\$90.49	\$85.73	\$81.92	86
	PE-034SR	Straight Cut Lead				0.28		<a href="#">PE3CA1102-3</a>	\$31.34	\$29.77	\$28.21	\$26.95	87
		Trimmed Lead				0.20		<a href="#">PE3CA1105-3</a>	\$35.59	\$33.81	\$32.03	\$30.61	88
	PE-047SR	Straight Cut Lead				<a href="#">PE3CA1103-3</a>		\$31.15	\$29.59	\$28.04	\$26.79	89	
		Trimmed Lead				<a href="#">PE3CA1106-3</a>		\$38.17	\$36.26	\$34.35	\$32.83	90	

See Web for other lengths

## 26.5 GHZ & 40 GHZ TEST CABLES

### Product Features



- Rugged Armored Jacket
- 1.38 Inch [3.5cm] Bend Radius
- RoHS Compliant



Connector 1	Connector 2	Freq. Max (GHz)	Imp (Ohm)	VSWR	IL @fmax (dB/ft)	Length (in)	Model No	1	2-4	5-9	10+	ROW
3.5mm Male	3.5mm Male	26.5	50	1.25	0.64	Various	<a href="#">PE3VNA2603</a>	Call	Call	Call	Call	91
3.5mm Female	3.5mm Female			1.3			<a href="#">PE3VNA2604</a>					92
2.92mm Male	2.92mm Male			1.25			<a href="#">PE3VNA2605</a>					93
		<a href="#">PE3VNA2606</a>	94									
2.92mm Female	2.92mm Female	40	1.38	0.83	<a href="#">PE3VNA4001</a>	Call	Call	Call	Call	<a href="#">PE3VNA4002</a>	95	
2.4mm Male	2.4mm Male				<a href="#">PE3VNA4004</a>					96		
2.4mm Female	2.4mm Female				<a href="#">PE3VNA4004</a>					97		
					<a href="#">PE3VNA4005</a>					98		

# INDEX GUIDE TO TOOLS

<b>TOOLS.....</b>	<b>319</b>
<b>CABLE CUTTER.....</b>	<b>319</b>
<b>CRIMP TOOL DIES.....</b>	<b>321</b>
<b>CRIMP TOOLS.....</b>	<b>321</b>
<b>INSERTION / EXTRACTION TOOL.....</b>	<b>319</b>
<b>TORQUE WRENCHES.....</b>	<b>320</b>

TOOLS							
Cable Cutter							
							
Type	Coax/Wire Type	Model No	1-24	25-49	50-99	100+	ROW
Cable Cutter	Coax	<a href="#">PE5200</a>	\$103.09	\$97.94	\$92.78	\$88.66	1
Insertion/Extraction Tool							
							
Type	Connector Type	Model No	1-24	25-49	50-99	100+	ROW
Insertion/Extraction Tool	BNC	<a href="#">PE5014</a>	Call	Call	Call	Call	2

Tools



Technical Support  
+1 (949) 261-1920



Same-Day Shipping,  
Even Custom  
Cable Assemblies

## Torque Wrenches



See Our Website For Current Pricing & Real-Time Stock Availability!

Type	Bit Hex Size	Preset Torque (in.-lbs)	Design	Model No	1-9	10-24	25-49	50+	R O W	
1.0mm	15/64 inch	4	Break-Over	<a href="#">PE5019-16</a>	\$224.24	\$213.03	\$201.82	\$192.85	3	
3.5mm, 2.92mm	5/16 inch	8		<a href="#">PE5019-1</a>	Call	Call	Call	Call		
		12		<a href="#">PE5019-2</a>	Call	Call	Call	Call		
7mm	3/4 inch	14	Click Type	<a href="#">PE5011-3</a>	\$364.86	\$346.62	\$328.37	\$313.78	4	
N	20 mm	8.1	Break-Over	<a href="#">PE5019-5</a>	\$224.24	\$213.03	\$201.82	\$192.85	3	
		14	Click Type	<a href="#">PE5011-7</a>	\$318.02	\$305.30	\$295.76	\$289.40	4	
	25/32 inch		8.1	Break-Over	<a href="#">PE5019-6</a>	\$222.15	\$211.04	\$199.94	\$191.05	3
3/4 inch	<a href="#">PE5019-3</a>	\$222.15			\$211.04	\$199.94	\$191.05			
	N, 7mm	14	<a href="#">PE5019-4</a>		\$222.15	\$211.04	\$199.94	\$191.05		
N, SC	13/16 inch	8.1	Click Type	<a href="#">PE5019-7</a>	\$222.15	\$211.04	\$199.94	\$191.05	4	
		14		<a href="#">PE5011-6</a>	\$354.87	\$337.13	\$319.38	\$305.19		
SMA	5/16 inch		5	Break-Over	<a href="#">PE5019-8</a>	\$222.15	\$211.04	\$199.94	\$191.05	3
SMA, 2.92mm		8			<a href="#">PE5019-19</a>	Call	Call	Call	Call	
SMC	1/4 inch	3	Click Type	<a href="#">PE5011-1</a>	\$228.23	\$219.10	\$212.25	\$207.69	4	
	15/64 inch			<a href="#">PE5011-2</a>	\$333.13	\$316.47	\$299.82	\$286.49		
SSMA	1/4 inch	5	Break-Over	<a href="#">PE5019-11</a>	\$224.24	\$213.03	\$201.82	\$192.85	3	
				<a href="#">PE5019-13</a>	\$224.24	\$213.03	\$201.82	\$192.85		
		8	Click Type	<a href="#">PE5011-5</a>	\$333.13	\$316.47	\$299.82	\$286.49	4	
SSMC	5/32 inch	8.1	Break-Over	<a href="#">PE5019-14</a>	\$224.24	\$213.03	\$201.82	\$192.85	3	
				<a href="#">PE5019-12</a>	\$222.15	\$211.04	\$199.94	\$191.05		
		2		<a href="#">PE5019-18</a>	\$239.94	\$227.94	\$215.95	\$206.35		
TNC	5/8 inch	6.1	Break-Over	<a href="#">PE5019-10</a>	\$222.15	\$211.04	\$199.94	\$191.05	4	
		12		Click Type	<a href="#">PE5011-4</a>	\$333.13	\$316.47	\$299.82		\$286.49
		14			<a href="#">PE5019-17</a>	\$224.24	\$213.03	\$201.82		\$192.85
	9/16 inch	6.1	Break-Over	<a href="#">PE5019-9</a>	\$222.15	\$211.04	\$199.94	\$191.05	3	
		12		<a href="#">PE5011-8</a>	\$314.28	\$298.57	\$282.85	\$270.28		
		13	Click Type					4		

Tools

### Crimp Tools



Type	Hex Size (in.)	Compatible Dies	Cable Type	Model No	1 Pc. Price	See Web for Volume Pricing			ROW
Crimp Tools	0.068, 0.100, 0.128, 0.178	---	RG174, RG179, RG180, RG187, RG188, RG195, RG316	<a href="#">PE5006</a>	Call				5
	0.068, 0.213, 0.255		RG55, RG58, RG59, RG62, RG142, RG223, RG400	<a href="#">PE5001</a>	Call				6
	0.100, 0.429		RG9, RG11, RG87A, RG149, RG165, RG213, RG214, RG216, RG225, RG393	<a href="#">PE5007</a>	\$169.45				7
Crimp Tool Kit	0.042, 0.068, 0.080, 0.100, 0.128, 0.151, 0.178, 0.213, 0.255, 0.324, 0.429	---	RG5, RG6, RG8, RG9, RG11, RG21, RG55, RG58, RG59, RG62, RG87A, RG140, RG141, RG142, RG143, RG165, RG174, RG179, RG180, RG187, RG188, RG195, RG210, RG212, RG213, RG214, RG216, RG222, RG223, RG225, RG303, RG304, RG316, RG393, RG400	<a href="#">PE5004-KIT</a>	\$386.07				8
Crimp Tool, Scissor style, No Die	---	PE5010-1, PE5010-2, PE5010-3, PE5010-4, PE5010-5 and PE5010-6	---	<a href="#">PE5008</a>	Call				9
Crimp Tool, Straight Style, No Die	---	PE5010-1, PE5010-2, PE5010-3, PE5010-4, PE5010-5 and PE5010-6	---	<a href="#">PE5009</a>	Call				10
Crimp Tool for Compression Connectors	---	---	RG6, RG11, RG59	<a href="#">PE5012</a>	\$151.70				11

### Crimp Tool Dies



Type	Hex Size (in.)	Compatible Crimp Tools	Cable Type	Model No	1 Pc. Price	See Web for Volume Pricing			ROW
Dies, Crimp Tool	0.128, 0.100	PE5008 and PE5009	RG174, RG178, RG179, RG188, RG196, RG316	<a href="#">PE5010-2</a>	Call				12
	0.213, 0.068		RG58, RG142, RG223, RG400	<a href="#">PE5010-1</a>	Call				
	0.255, 0.068		RG8X, RG59, RG62, PE-C240	<a href="#">PE5010-3</a>	Call				
	0.429, 0.100		RG8, RG213, RG214, PE-B400, PE-B405, PE-C400	<a href="#">PE5010-5</a>	Call				



Technical Support  
+1 (949) 261-1920



Same-Day Shipping,  
Even Custom Cable Assemblies

# INDEX GUIDE TO WAVEGUIDE PRODUCTS

## WAVEGUIDE ANTENNAS.....324

**WAVEGUIDE ANTENNAS.....324** | **WG ANTENNA ACCESSORIES.....329**

Pasternack offers a large selection of waveguide antennas from WR-284 to WR-15 (2.6 GHz to 75 GHz) in a variety of flanges and gain. Both UG and CPR/CMR style flanges are available. Most of the gain horn antennas can be purchased already assembled with a waveguide to coax adapter.

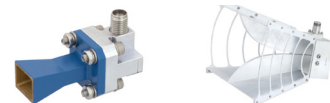

## WAVEGUIDE BENDS.....332



Pasternack offers a selection of E and H plane waveguide bends of various flanges and interfaces, covering the frequency range from 5.85 GHz to 18 GHz with VSWR as low as 1.08:1.

## WAVEGUIDE FILTERS.....332

**BANDPASS.....332**

Pasternack offers a selection of high performance waveguide bandpass filters, covering the frequency range from 20.2 GHz to 40 GHz with WR-28 and WR-42 interfaces. These filters exhibit excellent out-of-band rejection making them ideally suited to receiver front-end or transmitter applications.



## WAVEGUIDE BULKHEAD ADAPTERS.....333



The Pasternack series of rectangular waveguide bulkhead flange mount adapters are mounted to the panel of equipment with screws. Once mounted, waveguides flanges can be attached to the adapter on both sides of the bulkhead adapter to allow a signal path through the panel.

## WAVEGUIDE CONVERTERS.....333

**MIXER DOWN CONVERTERS.....333** | **MIXER UP CONVERTERS.....334**

Pasternack offers a series of Millimeter Wave Up and Down Converter Mixers that cover popular Ka, Q, U, V, E, and W Bands up to 110 GHz with an IF frequency of DC to 18 GHz. L and R ports support popular waveguide sizes from WR-28 to WR-10, and the IF port utilize Female SMA connectors.



## WAVEGUIDE COUPLERS.....334

**ASSEMBLIES.....339** | **BROADWALL.....334** | **CROSSGUIDE.....335**



Pasternack offers a brand new family of instrumentation grade directional waveguide couplers boasting accurate performance up to 110 GHz in seven popular frequency bands including K, Ka, Q, U, V, E and W bands. These waveguide couplers boast high directivity of 30 dB typical and insertion loss is as low as 0.6 dB in some models.

## WAVEGUIDE DETECTORS.....339

Waveguide detectors consists of 6 unique models covering a broad frequency range of 26.5 GHz to 110 GHz. The input ports use popular waveguide sizes ranging from WR-28 to WR-10, while the video output ports utilize SMA female connectors. The detector circuits use high performance GaAs Schottky Barrier Beam lead diodes with extremely low junction capacitance.



## WAVEGUIDE DIRECT READ ATTENUATORS.....340



These continuously variable attenuators have "direct read" capability which allows the user to dial-in the amount of attenuation needed to within 2% accuracy over most of the attenuation range. The attenuation level is stable, highly repeatable and accurate across the full frequency and attenuation range. These attenuators are ideal for precision measurements in demanding applications like instrumentation and system calibration.

## WAVEGUIDE ELECTROMECHANICAL RELAY SWITCHES.....340

Pasternack offers a series of 28 waveguide electromechanical relay switch models that offer full waveguide performance covering C, X, Ku, K and Ka frequency bands from 5.85 GHz to 40 GHz. These switches re configured for single-pole double-throw (SPDT) operation with latching self-cut-off actuators, TTL logic and position indicators with manual override.





**FLEXIBLE WAVEGUIDES.....341**

**SEAMLESS.....341**

**TWISTABLE.....342**

This family of flexible, seamless waveguides or flexible, twistable waveguides that can be bent in both the E and H planes without impairing VSWR or attenuation. These waveguides are covered by a neoprene jacket which protect the waveguide and provides mechanical support.



**WAVEGUIDE ISOLATORS.....342**



Pasternack Enterprises offers a wide variety of waveguide isolators from WR-10 to WR-112. These are two-port devices that transmit microwave or radio frequency power in one direction only and block the signal in the opposite direction.

**WAVEGUIDE LOW NOISE AMPLIFIERS.....343**

Pasternack Waveguide Low Noise Amplifiers are ruggedly built 50 ohm designs and unconditionally stable with impressive performance across broadband waveguide frequency bands



**WAVEGUIDE MAGIC TEES.....343**

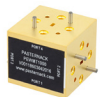

Pasternack's magic, or hybrid tees are 4 port device that is internally tuned to optimize matching, balance, and isolation. A signal applied to the H port will be equally divided between the two collinear ports. A signal applied to the E port will be divided between the two collinear ports but with a 180 degree phase difference. Similarly, when two in-phase signals of equal amplitude are applied to the collinear ports, these will be added together at the H-plane (sum) port and subtracted from one another at the E-plane (difference) port.

**WAVEGUIDE ORTHOMODE TRANSDUCERS.....343**

These Orthomode Transducers are used for separating signals into two linear orthogonal signals. The OMT supports circular, elliptical and linear polarized waves. Pasternack's OMT line support from 8.2 to 90 GHz with 30-35 dB of isolation between ports.



**WAVEGUIDE PHASE SHIFTERS.....343 WAVEGUIDE TERMINATIONS.....346**



These waveguide variable phase shifters are built using low loss dielectric material, which offers minimum insertion loss..



Pasternack has a large family of high performance loads from WR-112 to WR-10. These standard terminations can dissipate up to 300 Watts of power depending on the specific band.

**WAVEGUIDE PIN DIODE SWITCHES.....344 WAVEGUIDE TRANSITIONS.....347**

Waveguide PIN Diode Switches consist of 4 models that cover 60 GHz to 110 GHz, in both SPST and SPDT configurations.



Pasternack's family of Waveguide Transitions/Adapters are used as a means of propagating RF/Microwave energy from one waveguide size to another.



**WAVEGUIDE POLARIZERS.....344 WAVEGUIDE TWISTS.....348**



Pasternack's Waveguide Polarizers transform polarized signals from circular to linear and vice versa. They can operate as either right hand or left hand polarization. Waveguide Polarizers currently cover Ku, Ka, and V bands.



Pasternack offers waveguide twists in 45 degree left and right hand waveguide versions as well at 90 degree. These twists are designed and constructed to prevent unwanted distortion to the signal's transmission.

**WAVEGUIDE POWER AMPLIFIERS.....344 WAVEGUIDE VARIABLE ATTEN.....348**

Waveguide Power Amplifiers consist of 2 models that cover 70.5 GHz to 86.5 GHz (E Band) and support WR-12 waveguide ports. Performance includes small signal gain that ranges from 20 to 22 dB.



The Continuously Variable attenuators are equipped with a micrometer, which enables rapid re-setting. With calibrated charts, attenuators can be used as direct reading attenuator for bench top test set use.



**WAVEGUIDE SECTIONS.....345 WAVEGUIDE ACCESSORIES.....348**



Pasternack offers a standard product line of waveguide straight section of various length and flanges, covering the frequency range from 5.85 GHz to 12.4 GHz with VSWR as low as 1.03:1.



Pasternack Enterprises offers a variety of waveguide accessories from WR-10 to WR-430.

Waveguides

# WAVEGUIDE ANTENNAS

## Waveguide Antennas With Coax Adapters



Waveguide Type	RF Frequency (GHz.)	Gain (dB)	Flange Type - Connector	ECCN	Model No	1	2-4	5-9	10+	R O W
WR-28	26.5 - 40	10	WR-28 - 2.92mm Female	EAR99	<a href="#">PE9850/2F-10</a>	\$1,678.81	\$1,611.66	\$1,544.51	\$1,477.35	1
		15			<a href="#">PE9850/2F-15</a>	\$1,739.67	\$1,670.08	\$1,600.50	\$1,530.91	2
		20			<a href="#">PE9850/2F-20</a>	\$1,776.41	\$1,705.35	\$1,634.30	\$1,563.24	3
WR-34	22 - 33	10	WR-34 - 2.92mm Female	EAR99	<a href="#">PE9851/2F-10</a>	\$1,710.56	\$1,642.14	\$1,573.72	\$1,505.29	4
		15			<a href="#">PE9851/2F-15</a>	\$1,864.00	\$1,789.44	\$1,714.88	\$1,640.32	5
		20			<a href="#">PE9851/2F-20</a>	\$1,991.00	\$1,911.36	\$1,831.72	\$1,752.08	6
WR-42	18 - 26.5	10	WR-42 - 2.92mm Female	EAR99	<a href="#">PE9852/2F-10</a>	\$1,504.32	\$1,444.15	\$1,383.97	\$1,323.80	7
		15			<a href="#">PE9852/2F-15</a>	\$1,495.73	\$1,435.90	\$1,376.07	\$1,316.24	8
		20			<a href="#">PE9852/2F-20</a>	\$1,527.56	\$1,466.46	\$1,405.36	\$1,344.25	9
		15			Call	Call	Call	Call	10	
WR-51	15 - 22	10	WR-51 - SMA Female	EAR99	<a href="#">PE9853/SF-10</a>	\$1,321.51	\$1,268.65	\$1,215.79	\$1,162.93	11
		15			<a href="#">PE9853/SF-15</a>	\$1,635.27	\$1,569.86	\$1,504.45	\$1,439.04	12
		20			<a href="#">PE9853/SF-20</a>	\$1,621.76	\$1,556.89	\$1,492.02	\$1,427.15	13
WR-62	12.4 - 18	10	WR-62 - N Female	EAR99	<a href="#">PE9854/NF-10</a>	\$1,225.45	\$1,176.43	\$1,127.41	\$1,078.40	14
		15			<a href="#">PE9854/NF-15</a>	\$1,313.05	\$1,260.53	\$1,208.01	\$1,155.48	15
		20			<a href="#">PE9854/NF-20</a>	\$1,350.22	\$1,296.21	\$1,242.20	\$1,188.19	16
		10	WR-62 - SMA Female	EAR99	<a href="#">PE9854/SF-10</a>	\$1,312.81	\$1,260.30	\$1,207.79	\$1,155.27	17
		15			<a href="#">PE9854/SF-15</a>	\$1,355.59	\$1,301.37	\$1,247.14	\$1,192.92	18
		20			<a href="#">PE9854/SF-20</a>	\$1,293.72	\$1,241.97	\$1,190.22	\$1,138.47	19
WR-75	10 - 15	10	WR-75 - N Female	EAR99	<a href="#">PE9855/NF-10</a>	\$1,332.60	\$1,279.30	\$1,225.99	\$1,172.69	20
		15			<a href="#">PE9855/NF-15</a>	\$1,243.95	\$1,194.19	\$1,144.43	\$1,094.68	21
		20			<a href="#">PE9855/NF-20</a>	\$1,354.17	\$1,300.00	\$1,245.84	\$1,191.67	22
		10	WR-75 - SMA Female	EAR99	<a href="#">PE9855/SF-10</a>	\$1,306.04	\$1,253.80	\$1,201.56	\$1,149.32	23
		15			<a href="#">PE9855/SF-15</a>	\$1,306.09	\$1,253.85	\$1,201.60	\$1,149.36	24
		20			<a href="#">PE9855/SF-20</a>	\$1,315.58	\$1,262.96	\$1,210.33	\$1,157.71	25
10	Call	Call	Call	Call	26					
WR-90	8.2 - 12.4	10	WR-90 - N Female	EAR99	<a href="#">PE9856/NF-10</a>	\$1,248.74	\$1,198.79	\$1,148.84	\$1,098.89	27
		15			<a href="#">PE9856/NF-15</a>	\$1,334.35	\$1,280.98	\$1,227.60	\$1,174.23	28
		20			<a href="#">PE9856/NF-20</a>	\$1,276.43	\$1,225.37	\$1,174.32	\$1,123.26	29
		10	WR-90 - SMA Female	EAR99	<a href="#">PE9856/SF-10</a>	\$1,181.12	\$1,133.88	\$1,086.63	\$1,039.39	30
		15			<a href="#">PE9856/SF-15</a>	\$1,273.12	\$1,222.20	\$1,171.27	\$1,120.35	31
		20			<a href="#">PE9856/SF-20</a>	\$1,327.50	\$1,274.40	\$1,221.30	\$1,168.20	32
WR-102	7 - 11	10	WR-102 - N Female	EAR99	<a href="#">PE9857/NF-10</a>	\$1,267.83	\$1,217.12	\$1,166.40	\$1,115.69	33
		15			<a href="#">PE9857/NF-15</a>	\$1,492.80	\$1,433.09	\$1,373.38	\$1,313.66	34
		20			<a href="#">PE9857/NF-20</a>	\$1,487.44	\$1,427.94	\$1,368.44	\$1,308.95	35
		10	WR-102 - SMA Female	EAR99	<a href="#">PE9857/SF-10</a>	\$1,303.36	\$1,251.23	\$1,199.09	\$1,146.96	36
		15			<a href="#">PE9857/SF-15</a>	\$1,514.49	\$1,453.91	\$1,393.33	\$1,332.75	37
		20			<a href="#">PE9857/SF-20</a>	\$1,438.95	\$1,381.39	\$1,323.83	\$1,266.28	38
WR-112	7.05 - 10	10	WR-112 - N Female	EAR99	<a href="#">PE9858/NF-10</a>	\$1,191.44	\$1,143.78	\$1,096.12	\$1,048.47	39
		15			<a href="#">PE9858/NF-15</a>	\$1,368.99	\$1,314.23	\$1,259.47	\$1,204.71	40
		20			<a href="#">PE9858/NF-20</a>	\$1,429.87	\$1,372.68	\$1,315.48	\$1,258.29	41
		10	WR-112 - SMA Female	EAR99	<a href="#">PE9858/SF-10</a>	\$1,271.97	\$1,221.09	\$1,170.21	\$1,119.33	42
		15			<a href="#">PE9858/SF-15</a>	\$1,414.53	\$1,357.95	\$1,301.37	\$1,244.79	43
		20			<a href="#">PE9858/SF-20</a>	\$1,389.55	\$1,333.97	\$1,278.39	\$1,222.80	44
WR-137	5.85 - 8.2	10	WR-137 - N Female	EAR99	<a href="#">PE9859/NF-10</a>	\$1,344.20	\$1,290.43	\$1,236.66	\$1,182.90	45
		15			<a href="#">PE9859/NF-15</a>	\$1,451.65	\$1,393.58	\$1,335.52	\$1,277.45	46
		20			<a href="#">PE9859/NF-20</a>	\$1,484.29	\$1,424.92	\$1,365.55	\$1,306.18	47
		10	WR-137 - SMA Female	EAR99	<a href="#">PE9859/SF-10</a>	\$1,465.18	\$1,406.57	\$1,347.97	\$1,289.36	48
		15			<a href="#">PE9859/SF-15</a>	\$1,522.76	\$1,461.85	\$1,400.94	\$1,340.03	49
		20			<a href="#">PE9859/SF-20</a>	\$1,462.63	\$1,404.12	\$1,345.62	\$1,287.11	50
WR-159	4.9 - 7.05	10	WR-159 - N Female	EAR99	<a href="#">PE9860/NF-10</a>	\$1,579.57	\$1,516.39	\$1,453.20	\$1,390.02	51
		15			<a href="#">PE9860/NF-15</a>	\$1,759.65	\$1,689.26	\$1,618.88	\$1,548.49	52
		20			<a href="#">PE9860/NF-20</a>	\$1,800.39	\$1,728.37	\$1,656.36	\$1,584.34	53
		10	WR-159 - SMA Female	EAR99	<a href="#">PE9860/SF-10</a>	\$1,624.35	\$1,559.38	\$1,494.40	\$1,445.67	54
		15			<a href="#">PE9860/SF-15</a>	\$1,752.95	\$1,682.83	\$1,612.71	\$1,542.60	55
		20			<a href="#">PE9860/SF-20</a>	\$1,710.56	\$1,642.14	\$1,573.72	\$1,505.29	56
WR-187	3.95 - 5.85	10	WR-187 - N Female	EAR99	<a href="#">PE9861/NF-10</a>	\$1,473.93	\$1,414.97	\$1,356.02	\$1,297.06	57
		15			<a href="#">PE9861/NF-15</a>	\$1,949.39	\$1,871.41	\$1,793.44	\$1,715.46	58
		20			<a href="#">PE9861/NF-20</a>	\$2,033.26	\$1,951.93	\$1,870.60	\$1,789.27	59
		10	WR-187 - SMA Female	EAR99	<a href="#">PE9861/SF-10</a>	\$1,829.16	\$1,755.99	\$1,682.83	\$1,609.66	60
		15			<a href="#">PE9861/SF-15</a>	\$2,006.37	\$1,926.12	\$1,845.86	\$1,765.61	61
		20			<a href="#">PE9861/SF-20</a>	\$1,964.54	\$1,885.96	\$1,807.38	\$1,728.80	62
WR-229	3.3 - 4.9	15	WR-229 - N Female	EAR99	<a href="#">PE9862/NF-15</a>	\$1,677.01	\$1,609.93	\$1,542.85	\$1,475.77	63
		20			<a href="#">PE9862/NF-20</a>	\$2,209.42	\$2,121.04	\$2,032.67	\$1,944.29	64
		15			WR-229 - SMA Female	EAR99	<a href="#">PE9862/SF-15</a>	\$2,022.75	\$1,941.84	\$1,860.93
		20	<a href="#">PE9862/SF-20</a>	\$2,257.95			\$2,167.63	\$2,077.31	\$1,987.00	66
		10	WR-229 - N Female	EAR99			<a href="#">PE-W229AN001/NF-10</a>	Call	Call	Call

## Waveguide Antennas With Coax Adapters



Waveguide Type	RF Frequency (GHz.)	Gain (dB)	Flange Type - Connector	ECCN	Model No	1	2-4	5-9	10+	ROW
WR-229	3.3 - 4.9	10	WR-229 - SMA Female	EAR99	<a href="#">PE-W229AN001/SF-10</a>	Call	Call	Call	Call	68
WR-284	2.6 - 3.95	10	WR-284 - N Female	EAR99	<a href="#">PE9863/NF-10</a>	\$2,150.39	\$2,064.37	\$1,978.36	\$1,892.34	69
		20		EAR99	<a href="#">PE9863/NF-20</a>	\$3,075.02	\$2,952.02	\$2,829.02	\$2,706.02	70
		10	WR-284 - SMA Female	EAR99	<a href="#">PE9863/SF-10</a>	\$2,416.44	\$2,319.78	\$2,223.12	\$2,126.47	71
		20		EAR99	<a href="#">PE9863/SF-20</a>	\$3,246.83	\$3,116.96	\$2,987.08	\$2,857.21	72
		15		EAR99	<a href="#">PEWAN1002</a>	Call	Call	Call	Call	73
WR-430	1.7 - 2.6	10	WR-430 - N Female	EAR99	<a href="#">PE9864/NF-10</a>	\$2,890.59	\$2,774.97	\$2,659.34	\$2,543.72	74
		15		EAR99	<a href="#">PE9864/NF-15</a>	\$3,659.20	\$3,512.83	\$3,366.46	\$3,220.10	75
		20		EAR99	<a href="#">PE9864/NF-20</a>	\$5,138.20	\$4,932.67	\$4,727.14	\$4,521.62	76
		10	WR-430 - SMA Female	EAR99	<a href="#">PE9864/SF-10</a>	\$2,845.00	\$2,731.20	\$2,617.40	\$2,503.60	77
		15		EAR99	<a href="#">PE9864/SF-15</a>	\$3,588.83	\$3,445.28	\$3,301.72	\$3,158.17	78
		20		EAR99	<a href="#">PE9864/SF-20</a>	\$4,927.62	\$4,730.52	\$4,533.41	\$4,336.31	79

## Standard Gain Horns



Waveguide Type	RF Frequency (GHz.)	Gain (dB)	Flange Type	ECCN	Model No	1 Pc. Price	See Web for Volume Pricing	ROW
WR-5	140 - 220	10	Round Cover UG-387/U-Mod	EAR99	<a href="#">PEWAN1029</a>	\$2,062.50	See Web for Volume Pricing	80
		15		EAR99	<a href="#">PEWAN1030</a>	\$2,062.50		81
		20		EAR99	<a href="#">PEWAN1031</a>	\$2,062.50		82
		25		EAR99	<a href="#">PEWAN1032</a>	\$2,131.25		83
WR-6	110 - 170	10		EAR99	<a href="#">PEWAN1025</a>	\$1,687.50		84
		15		EAR99	<a href="#">PEWAN1026</a>	\$1,712.50		85
		20		EAR99	<a href="#">PEWAN1027</a>	\$1,737.50		86
		25		EAR99	<a href="#">PEWAN1028</a>	\$2,013.06		87
WR-8	90 - 140	10		EAR99	<a href="#">PEWAN1021</a>	\$1,437.50		88
		15		EAR99	<a href="#">PEWAN1022</a>	\$1,462.50		89
		20		EAR99	<a href="#">PEWAN1023</a>	\$1,487.50		90
		25		EAR99	<a href="#">PEWAN1024</a>	\$1,875.00		91
WR-10	75 - 110	10	EAR99	<a href="#">PEWAN1017</a>	\$1,187.50	92		
		15	EAR99	<a href="#">PEWAN1018</a>	\$1,212.50	93		
		20	EAR99	<a href="#">PEWAN1019</a>	\$1,285.76	94		
		25	EAR99	<a href="#">PEWAN1020</a>	\$1,625.00	95		
WR-12	60 - 90	10	EAR99	<a href="#">PEWAN1013</a>	\$1,233.81	96		
		15	EAR99	<a href="#">PEWAN1014</a>	\$1,259.79	97		
		20	EAR99	<a href="#">PEWAN1015</a>	\$1,285.76	98		
		25	EAR99	<a href="#">PEWAN1016</a>	\$1,688.38	99		
WR-15	50 - 75	10	Round Cover UG-385/U-Mod	EAR99	<a href="#">PEWAN1009</a>	\$1,187.50		1
		15		EAR99	<a href="#">PEWAN1010</a>	\$1,259.79		2
		20		EAR99	<a href="#">PEWAN1011</a>	\$1,237.50		3
		24	Round Cover UG-385/U	5A991	<a href="#">PE9881-24</a>	\$1,479.18		4
WR-19	40 - 60	10	Round Cover UG-383/U-Mod	EAR99	<a href="#">PEWAN1012</a>	\$1,688.38	5	
		15		EAR99	<a href="#">PEWAN1005</a>	\$1,298.75	6	
		20		EAR99	<a href="#">PEWAN1006</a>	\$1,350.00	7	
		25		EAR99	<a href="#">PEWAN1007</a>	\$1,375.00	8	
WR-28	26.5 - 40	10	Square Cover UG-599/U	EAR99	<a href="#">PEWAN1008</a>	\$1,625.00	9	
		15		EAR99	<a href="#">PE9850-10</a>	\$866.19	10	
		20		EAR99	<a href="#">PE9850-15</a>	\$1,039.00	11	
		25		EAR99	<a href="#">PE9850-20</a>	\$980.59	12	
WR-34	22 - 33	10	Square Cover UG-1530/U	EAR99	<a href="#">PE9851-10</a>	\$840.73	13	
		15		EAR99	<a href="#">PE9851A-15</a>	\$967.00	14	
		20		EAR99	<a href="#">PE9851A-20</a>	\$1,094.00	15	
		25		EAR99	<a href="#">PE9852-10</a>	\$840.22	16	
WR-42	18 - 26.5	10	Square Cover UG-597/U	EAR99	<a href="#">PE9852A-15</a>	\$845.04	17	
		15		EAR99	<a href="#">PE9852-20</a>	\$1,069.57	18	
		20		EAR99	<a href="#">PE9853-10</a>	\$756.23	19	
		25		EAR99	<a href="#">PE9853-15</a>	\$994.61	20	
WR-51	15 - 22	10	Square Cover	EAR99	<a href="#">PE9853A-20</a>	\$889.50	21	
		15		EAR99	<a href="#">PE9854-10</a>	\$888.32	22	
		20		EAR99	<a href="#">PE9854-15</a>	\$826.66	23	
WR-62	12.4 - 18	20		EAR99	<a href="#">PE9854-20</a>	\$978.32	24	

See Our Website For Current Pricing & Real-Time Stock Availability!

Waveguides



Technical Support  
+1 (949) 261-1920



Same-Day Shipping,  
Even Custom  
Cable Assemblies

## Standard Gain Horns



See Our Website For Current Pricing & Real-Time Stock Availability!

Waveguide Type	RF Frequency (GHz.)	Gain (dB)	Flange Type	ECCN	Model No	1 Pc. Price	See Web for Volume Pricing	R O W
WR-75	10 - 15	10	Square Cover	EAR99	<a href="#">PE9855-10</a>	\$888.32	See Web for Volume Pricing	25
		15		EAR99	<a href="#">PE9855-15</a>	\$941.62		26
		20		EAR99	<a href="#">PE9855A-20</a>	\$830.23		27
WR-90	8.2 - 12.4	10	Square Cover UG-135/U	EAR99	<a href="#">PE9856-10</a>	\$852.45		28
		10	UG-135/U	EAR99	<a href="#">PE-W90AN001</a>	Call		29
		15	Square Cover UG-135/U	EAR99	<a href="#">PE9856-15</a>	\$966.84		30
20	EAR99	<a href="#">PE9856-20</a>		\$1,038.70	31			
10	EAR99	<a href="#">PE9858-10</a>		\$924.80	32			
WR-112	7.05 - 10	15	Square Cover	EAR99	<a href="#">PE9858-15</a>	\$994.61		33
		20		EAR99	<a href="#">PE9858A-20</a>	\$925.08		34
		10		EAR99	<a href="#">PE9857-10</a>	\$840.73		35
WR-102	7 - 11	15		EAR99	<a href="#">PE9857-15</a>	\$845.04		36
		20		EAR99	<a href="#">PE9857-20</a>	\$856.11		37
		10		EAR99	<a href="#">PE9859-10</a>	\$864.30		38
WR-137	5.85 - 8.2	15	CMR-137	EAR99	<a href="#">PE9859-15</a>	\$920.71		39
		20	CMR-159	EAR99	<a href="#">PE9859-20</a>	\$889.50		40
		10		EAR99	<a href="#">PE9860-10</a>	\$914.71		41
WR-159	4.9 - 7.05	15	Square Cover UG-1731/U	EAR99	<a href="#">PE9860-15</a>	\$983.44		42
		20	CMR-159	EAR99	<a href="#">PE9860-20</a>	\$993.24		43
		10	CMR-187	EAR99	<a href="#">PE9861-10</a>	\$856.11		44
15	EAR99	<a href="#">PE9861-15</a>		\$1,183.82	45			
20	EAR99	<a href="#">PE9861-20</a>		\$1,209.93	46			
WR-187	3.95 - 5.85	10		EAR99	<a href="#">PE-W229AN001</a>	\$1,010.46		47
		15		EAR99	<a href="#">PE9862-15</a>	\$1,265.10		48
		20		EAR99	<a href="#">PE9862-20</a>	\$1,586.41		49
WR-229	3.3 - 4.9	10	CMR-229	EAR99	<a href="#">PE9863-10</a>	\$1,296.57		50
		15		EAR99	<a href="#">PEWAN1001</a>	\$1,284.21		51
		20		EAR99	<a href="#">PE9863-20</a>	\$2,158.67		52
WR-284	2.6 - 3.95	10	CMR-284	EAR99	<a href="#">PE9864-10</a>	\$1,700.25		53
		15		EAR99	<a href="#">PE9864-15</a>	\$2,309.74		54
		20		EAR99	<a href="#">PE9864-20</a>	\$3,963.60	55	

## Conical Gain Horns



Waveguide Type	RF Frequency (GHz.)	Gain (dB)	Flange Type	ECCN	Model No	1 Pc. Price	See Web for Volume Pricing	R O W
WR-5	140 - 220	10	Round Cover UG-387/U	EAR99	<a href="#">PEWAN1065</a>	\$2,012.50	See Web for Volume Pricing	56
		15		EAR99	<a href="#">PEWAN1066</a>	\$2,037.50		57
		20		EAR99	<a href="#">PEWAN1067</a>	\$2,062.50		58
		25		EAR99	<a href="#">PEWAN1068</a>	\$2,214.37		59
WR-6	100 - 112	10	Round Cover UG-387/U-Mod	EAR99	<a href="#">PEWAN1061</a>	\$1,687.50		60
		15		EAR99	<a href="#">PEWAN1062</a>	\$1,712.50		61
		20		EAR99	<a href="#">PEWAN1063</a>	\$1,737.50		62
		25		EAR99	<a href="#">PEWAN1064</a>	\$1,937.50		63
WR-8	100 - 112	10		EAR99	<a href="#">PEWAN1057</a>	\$1,212.50		64
		15		EAR99	<a href="#">PEWAN1058</a>	\$1,237.50		65
		20		EAR99	<a href="#">PEWAN1059</a>	\$1,375.00		66
		25		EAR99	<a href="#">PEWAN1060</a>	\$1,625.00		67
WR-10	87 - 100	10	Round Cover UG-387/U	EAR99	<a href="#">PEWAN1049</a>	\$1,212.50		68
		15		EAR99	<a href="#">PEWAN1050</a>	\$1,237.50		69
		20		EAR99	<a href="#">PEWAN1051</a>	\$1,375.00		70
		25		EAR99	<a href="#">PEWAN1052</a>	\$1,625.00		71
WR-12	77 - 87	10		EAR99	<a href="#">PEWAN1053</a>	\$1,212.50		72
		15		EAR99	<a href="#">PEWAN1054</a>	\$1,237.50		73
		20		EAR99	<a href="#">PEWAN1055</a>	\$1,375.00		74
		25		EAR99	<a href="#">PEWAN1056</a>	\$1,625.00		75
WR-12	68 - 77	10		EAR99	<a href="#">PEWAN1045</a>	\$1,212.50		76
		15		EAR99	<a href="#">PEWAN1046</a>	\$1,237.50		77
		20		EAR99	<a href="#">PEWAN1047</a>	\$1,375.00		78
		25		EAR99	<a href="#">PEWAN1048</a>	\$1,625.00		79
WR-12	68 - 77	10		EAR99	<a href="#">PEWAN1041</a>	\$1,212.50		80
		15		EAR99	<a href="#">PEWAN1042</a>	\$1,237.50		81

Waveguides

### Conical Gain Horns



Waveguide Type	RF Frequency (GHz.)	Gain (dB)	Flange Type	ECCN	Model No	1	2-4	5-9	10+	ROW
WR-12	68 - 77	20	Round Cover UG-387/U	EAR99	<a href="#">PEWAN1043</a>	\$1,375.00	\$1,326.88	\$1,278.75	\$1,237.50	82
		25		EAR99	<a href="#">PEWAN1044</a>	\$1,625.00	\$1,568.13	\$1,511.25	\$1,462.50	83
WR-15	58 - 68	10	Round Cover UG-385/U	EAR99	<a href="#">PEWAN1037</a>	\$1,212.50	\$1,170.06	\$1,127.63	\$1,091.25	84
		15		EAR99	<a href="#">PEWAN1038</a>	\$1,237.50	\$1,194.19	\$1,150.88	\$1,113.75	85
		20		EAR99	<a href="#">PEWAN1039</a>	\$1,375.00	\$1,326.88	\$1,278.75	\$1,237.50	86
		25		EAR99	<a href="#">PEWAN1040</a>	\$1,625.00	\$1,568.13	\$1,511.25	\$1,462.50	87
WR-19	50 - 58	10	Round Cover UG-383/U-Mod	EAR99	<a href="#">PEWAN1033</a>	\$1,100.00	\$1,061.50	\$1,023.00	\$990.00	88
		15		EAR99	<a href="#">PEWAN1034</a>	\$1,237.50	\$1,194.19	\$1,150.88	\$1,113.75	89
		20		EAR99	<a href="#">PEWAN1035</a>	\$1,375.00	\$1,326.88	\$1,278.75	\$1,237.50	90
		25		EAR99	<a href="#">PEWAN1036</a>	\$1,625.00	\$1,568.13	\$1,511.25	\$1,462.50	91

### Wide Angle Scalar Feed Horns



Waveguide Type	RF Frequency (GHz.)	Gain (dB)	Flange Type	ECCN	Model No	1	2-4	5-9	10+	ROW
WR-10	100 - 112	17	Round Cover UG-387/U-Mod	EAR99	<a href="#">PEWAN1109</a>	\$5,125.00	\$4,945.63	\$4,766.25	\$4,612.50	92
		10	Round Cover UG-385/U-Mod	EAR99	<a href="#">PEWAN1073</a>	\$4,725.00	\$4,559.63	\$4,394.25	\$4,252.50	93
		10		EAR99	<a href="#">PEWAN1074</a>	\$3,325.00	\$3,208.63	\$3,092.25	\$2,992.50	94
WR-12	87 - 100	17	UG-387/U-Mod	EAR99	<a href="#">PEWAN1123</a>	\$4,625.00	\$4,463.13	\$4,301.25	\$4,162.50	95
		17		EAR99	<a href="#">PEWAN1122</a>	\$4,500.00	\$4,342.50	\$4,185.00	\$4,050.00	96
	72 - 82	10	Round Cover UG-385/U	EAR99	<a href="#">PEWAN1071</a>	\$4,725.00	\$4,559.63	\$4,394.25	\$4,252.50	97
		10		EAR99	<a href="#">PEWAN1072</a>	\$3,325.00	\$3,208.63	\$3,092.25	\$2,992.50	98
WR-15	68 - 77	17	UG-387/U-Mod	EAR99	<a href="#">PEWAN1120</a>	\$4,500.00	\$4,342.50	\$4,185.00	\$4,050.00	99
		17	UG-385/U-Mod	EAR99	<a href="#">PEWAN1118</a>	\$4,375.00	\$4,221.88	\$4,068.75	\$3,937.50	1
	55 - 65	10	Round Cover UG-385/U	EAR99	<a href="#">PEWAN1069</a>	\$4,725.00	\$4,559.63	\$4,394.25	\$4,252.50	2
		10		EAR99	<a href="#">PEWAN1070</a>	\$3,454.68	\$3,333.77	\$3,212.85	\$3,109.21	3
WR-28	33 - 38.5	17	UG-599/U	EAR99	<a href="#">PEWAN1115</a>	\$4,000.00	\$3,860.00	\$3,720.00	\$3,600.00	4
		17		EAR99	<a href="#">PEWAN1114</a>	\$4,000.00	\$3,860.00	\$3,720.00	\$3,600.00	5
	26 - 33	17		EAR99	<a href="#">PEWAN1113</a>	\$4,000.00	\$3,860.00	\$3,720.00	\$3,600.00	6
		16		Square Cover UG-1530/U	EAR99	<a href="#">PEWAN1110</a>	\$4,000.00	\$3,860.00	\$3,720.00	\$3,600.00

### Lens Gain Horns



Waveguide Type	RF Frequency (GHz.)	Gain (dB)	Flange Type	ECCN	Model No	1 Pc. Price	See Web for Volume Pricing			ROW
WR-10	89 - 99	34	Round Cover UG-387/U	EAR99	<a href="#">PEWAN1083</a>	\$4,725.00				8
		34		EAR99	<a href="#">PEWAN1085</a>	\$5,775.00				9
		40		EAR99	<a href="#">PEWAN1084</a>	\$5,075.00				10
		40		EAR99	<a href="#">PEWAN1086</a>	\$6,125.00				11
	88 - 100	48	Square Cover UG-387/U-Mod	EAR99	<a href="#">PEWAN1102</a>	\$9,375.00				12
WR-12	72 - 82	32	Round Cover UG-387/U	EAR99	<a href="#">PEWAN1079</a>	\$4,025.00	See Web for Volume Pricing			13
		32		EAR99	<a href="#">PEWAN1081</a>	\$5,075.00				14
		37		EAR99	<a href="#">PEWAN1080</a>	\$4,375.00				15
		37		EAR99	<a href="#">PEWAN1082</a>	\$5,425.00				16
WR-15	55 - 65	32	Round Cover UG-385/U	EAR99	<a href="#">PEWAN1075</a>	\$2,975.00				17
		32		EAR99	<a href="#">PEWAN1077</a>	\$4,025.00				18
		37		EAR99	<a href="#">PEWAN1076</a>	\$3,325.00				19
		37		EAR99	<a href="#">PEWAN1078</a>	\$4,375.00				20

## Omni Directional



Waveguide Type	RF Frequency (GHz.)	Gain (dB)	Flange Type	ECCN	Model No	1	2-4	5-9	10+	ROW
WR-10	90 - 100	0	Round Cover UG-387/U-Mod	EAR99	<a href="#">PEWAN1135</a>	\$4,625.00	\$4,463.13	\$4,301.25	\$4,162.50	21
		6.5	Square Cover UG-387/U-Mod	EAR99	<a href="#">PEWAN1136</a>	\$4,625.00	\$4,463.13	\$4,301.25	\$4,162.50	22
WR-12	89 - 99	2	Round Cover UG-387/U	EAR99	<a href="#">PEWAN1089</a>	\$6,825.00	\$6,586.13	\$6,347.25	\$6,142.50	23
		2		EAR99	<a href="#">PEWAN1088</a>	\$6,825.00	\$6,586.13	\$6,347.25	\$6,142.50	24
WR-15	75 - 79	2	Round Cover UG-387/U	EAR99	<a href="#">PEWAN1088</a>	\$6,825.00	\$6,586.13	\$6,347.25	\$6,142.50	24
		2		EAR99	<a href="#">PEWAN1134</a>	\$4,375.00	\$4,221.88	\$4,068.75	\$3,937.50	25
WR-15	58 - 62	3.5	Round Cover UG-385/U	EAR99	<a href="#">PEWAN1087</a>	\$6,825.00	\$6,586.13	\$6,347.25	\$6,142.50	26
WR-28	26.5 - 40	7.5	Square Cover UG-599/U	EAR99	<a href="#">PEWAN1133</a>	\$3,875.00	\$3,739.38	\$3,603.75	\$3,487.50	27

## Probe Waveguide Antennas



Waveguide Type	RF Frequency (GHz.)	Gain (dB)	Flange Type	ECCN	Model No	1	2-4	5-9	10+	ROW
WR-6	110 - 170	6.5	Round Cover UG-387/U-Mod	EAR99	<a href="#">PEWAN1124</a>	\$1,725.00	\$1,664.63	\$1,604.25	\$1,552.50	28
WR-8	90 - 140	6.5		EAR99	<a href="#">PEWAN1125</a>	\$1,725.00	\$1,664.63	\$1,604.25	\$1,552.50	29
WR-10	75 - 110	6.5		EAR99	<a href="#">PEWAN1126</a>	\$1,725.00	\$1,664.63	\$1,604.25	\$1,552.50	30
WR-12	60 - 90	6.5	Round Cover UG-387/U	EAR99	<a href="#">PEWAN1127</a>	\$1,725.00	\$1,664.63	\$1,604.25	\$1,552.50	31
WR-15	50 - 75	6.5	Round Cover UG-385/U	EAR99	<a href="#">PEWAN1128</a>	\$1,725.00	\$1,664.63	\$1,604.25	\$1,552.50	32
WR-19	40 - 60	6.5	Round Cover UG-383/U-Mod	EAR99	<a href="#">PEWAN1129</a>	\$1,725.00	\$1,664.63	\$1,604.25	\$1,552.50	33
WR-22	33 - 50	6.5	Round Cover UG-383/U	EAR99	<a href="#">PEWAN1130</a>	\$1,725.00	\$1,664.63	\$1,604.25	\$1,552.50	34
WR-28	26.5 - 40	6.5	Square Cover UG-599/U	EAR99	<a href="#">PEWAN1131</a>	\$1,725.00	\$1,664.63	\$1,604.25	\$1,552.50	35
WR-34	22 - 33	6.5	Square Cover UG-1530/U	EAR99	<a href="#">PEWAN1132</a>	\$1,725.00	\$1,664.63	\$1,604.25	\$1,552.50	36

## Sector Waveguide Antennas



Waveguide Type	RF Frequency (GHz.)	Gain (dB)	Flange Type	ECCN	Model No	1	2-4	5-9	10+	ROW
WR-28	30 - 40	0	Square Cover UG-599/U-Mod	EAR99	<a href="#">PEWAN1144</a>	\$3,200.00	\$3,088.00	\$2,976.00	\$2,880.00	37
	27.5 - 29.5	6	Square Cover UG-599/U	EAR99	<a href="#">PEWAN1143</a>	\$3,200.00	\$3,088.00	\$2,976.00	\$2,880.00	38

## Dual Polarized Scalar Feed Horns



Waveguide Type	RF Frequency (GHz.)	Gain (dB)	Flange Type	ECCN	Model No	1	2-4	5-9	10+	ROW
WR-10	75 - 110	13	UG-387/U-Mod	EAR99	<a href="#">PEWAN1121</a>	\$18,875.00	\$18,214.38	\$17,553.75	\$16,987.50	39
		15	Square Cover UG-387/U-Mod	EAR99	<a href="#">PEWAN1137</a>	\$8,625.00	\$8,323.13	\$8,021.25	\$7,762.50	40
		20		EAR99	<a href="#">PEWAN1141</a>	\$8,625.00	\$8,323.13	\$8,021.25	\$7,762.50	41
WR-12	60 - 90	13	UG-387/U	EAR99	<a href="#">PEWAN1119</a>	\$18,375.00	\$17,731.88	\$17,088.75	\$16,537.50	42
		15	Square Cover UG-387/U	EAR99	<a href="#">PEWAN1138</a>	\$8,125.00	\$7,840.63	\$7,556.25	\$7,312.50	43
		15	Square Cover UG-385/U	EAR99	<a href="#">PEWAN1139</a>	\$7,500.00	\$7,237.50	\$6,975.00	\$6,750.00	44
WR-15	50 - 75	13	UG-385/U-Mod	EAR99	<a href="#">PEWAN1117</a>	\$18,875.00	\$18,214.38	\$17,553.75	\$16,987.50	45
WR-19	40 - 60	13	UG-383/U-Mod	EAR99	<a href="#">PEWAN1116</a>	\$15,375.00	\$14,836.88	\$14,298.75	\$13,837.50	46
WR-22	33 - 50	15	Square Cover UG-383/U	EAR99	<a href="#">PEWAN1140</a>	\$7,000.00	\$6,755.00	\$6,510.00	\$6,300.00	47
WR-28	24 - 42	10	Square Choke UG-599/U	EAR99	<a href="#">PEWAN1142</a>	\$10,000.00	\$9,650.00	\$9,300.00	\$9,000.00	48
		15	UG-599/U	EAR99	<a href="#">PEWAN1112</a>	\$12,750.00	\$12,303.75	\$11,857.50	\$11,475.00	49
	15	EAR99		<a href="#">PEWAN1111</a>	\$11,500.00	\$11,097.50	\$10,695.00	\$10,350.00	50	

See Our Website For Current Pricing & Real-Time Stock Availability!

Waveguides

## Specialty Waveguide Antennas



Waveguide Type	RF Frequency (GHz.)	Gain (dB)	Flange Type	ECCN	Model No	1	2-4	5-9	10+	ROW
Broadband	1 - 18			EAR99	<a href="#">PE9887-11</a>	\$3,531.52	\$3,407.92	\$3,284.31	\$3,178.37	51
				EAR99	<a href="#">PE9888-11</a>	\$3,565.14	\$3,440.36	\$3,315.58	\$3,208.63	52
WR-15	50 - 75	42	Round Cover - UG-385/U	5A991	<a href="#">PE9881-42</a>	\$2,366.43	\$2,271.77	\$2,177.12	\$2,082.46	53
		20		EAR99	<a href="#">PE9881A-20</a>	\$1,083.69	\$1,040.34	\$996.99	\$953.65	54
	56.5 - 67			5A991	<a href="#">PE9881-34</a>	\$1,552.93	\$1,498.58	\$1,444.22	\$1,397.64	55

## WAVEGUIDE ANTENNA ACCESSORIES

### Waveguide to Coax Adapters



WG Type	RF Freq. (GHz.)	IL (dB)	Max VSWR	Flange Type	Connector	ECCN	Model No	1 Pc. Price	See Web for Volume Pricing	ROW
WR-10	75-110	1	1.32:1	Round Cover UG-387/U-Mod	1.0mm Female	EAR99	<a href="#">PE-W10CA003</a>	\$5,210.00		56
			1.9:1		1.0mm Female	EAR99	<a href="#">PE-W10CA001</a>	Call	57	
WR-12	60-90	1.67:1	1.44:1	Round Cover UG-387/U	1.0mm Female	EAR99	<a href="#">PE-W10CA002</a>	\$5,210.00		58
					1.0mm Male	EAR99	<a href="#">PE-W12CA001</a>	\$5,199.79	59	
WR-15	50-65	0.5	1.44:1	Round Cover UG-385/U	1.85mm Female	EAR99	<a href="#">PE-W12CA002</a>	\$5,036.33		60
					1.85mm Male	EAR99	<a href="#">PE-W15CA001</a>	\$1,403.93	61	
WR-19	40-60	0.4	1.38:1	Round Cover UG-383/U-Mod	1.85mm Female	EAR99	<a href="#">PE-W15CA002</a>	\$1,446.42		62
					1.85mm Male	EAR99	<a href="#">PE-W19CA001</a>	\$1,509.18	63	
WR-22	33-50	1.33:1	1.44:1	Round Cover UG-383/U	2.4mm Female	EAR99	<a href="#">PE-W19CA002</a>	\$1,371.98		64
					2.4mm Male	EAR99	<a href="#">PE-W22CA001</a>	\$1,564.80	65	
					2.4mm Female	EAR99	<a href="#">PE-W22CA002</a>	\$1,319.88	66	
WR-28	26.5-40	0.3	1.25:1	Square Cover UG-599/U	2.92mm Female	EAR99	<a href="#">PEW22CA100</a>	\$1,564.80		67
		0.35			2.92mm Male	EAR99	<a href="#">PEWCA1078</a>	Call	68	
		1.29:1			2.92mm Female	EAR99	<a href="#">PEWCA1078</a>	\$762.91	69	
		1.3:1			2.92mm Female	EAR99	<a href="#">PEWCA1000</a>	\$856.89	70	
		0.3			2.92mm Female	EAR99	<a href="#">PEWCA1020</a>	\$719.45	71	
WR-34	22-33	0.3	1.25:1	Square Cover	2.92mm Female	EAR99	<a href="#">PE9826</a>	\$479.20		72
					2.92mm Female	EAR99	<a href="#">PEWCA1001</a>	\$708.58	73	
WR-42	18-26.5	0.3	1.03:1	Square Cover UG-597/U	2.92mm Female	EAR99	<a href="#">PEWCA1021</a>	\$653.55		74
					2.92mm Female	EAR99	<a href="#">PE9827</a>	\$844.10	75	
					1.25:1	SMA Female	EAR99	<a href="#">PEWCA1026</a>	\$658.03	76
					1.25:1	SMA Female	EAR99	<a href="#">PEWCA1019</a>	\$522.59	77
					1.25:1	SMA Female	EAR99	<a href="#">PEWCA1018</a>	\$741.91	78
WR-51	15-22	0.3	1.29:1	Square Cover UG-597/U	2.92mm Female	EAR99	<a href="#">PE-W42CA001</a>	\$762.91	See Web for Volume Pricing	79
					2.92mm Male	EAR99	<a href="#">PE-W42CA002</a>	\$762.91	80	
					2.92mm Female	EAR99	<a href="#">PEWCA1070</a>	\$873.33	81	
					2.92mm Female	EAR99	<a href="#">PEWCA1022</a>	\$569.90	82	
					1.4:1	SMA Female	EAR99	<a href="#">PEWCA1022</a>	\$569.90	83
					1.4:1	Square Cover	EAR99	<a href="#">PE9878</a>	\$572.46	84
					1.4:1	Square Cover UG-597/U	EAR99	<a href="#">PE9813A</a>	\$610.70	85
					1.25:1	Square Type	EAR99	<a href="#">PE9812</a>	\$459.34	86
					1.25:1	Square Cover	EAR99	<a href="#">PEWCA1002A</a>	\$527.96	87
					1.3:1	Square Type	EAR99	<a href="#">PEWCA1027</a>	\$736.36	88
WR-62	12.4-18	0.3	1.2:1	Square Cover UG-1665/U	SMA Female	EAR99	<a href="#">PE9828</a>	\$564.89		89
					SMA Female	EAR99	<a href="#">PE9879</a>	\$757.71	90	
					SMA Male	EAR99	<a href="#">PE9809</a>	\$377.25	91	
	11.9-18	0.2	1.25:1	Square Cover UG-419/U	N Female	EAR99	<a href="#">PEWCA1028</a>	\$649.58		92
					SMA Female	EAR99	<a href="#">PEWCA1023</a>	\$536.99	93	
					SMA Female	EAR99	<a href="#">PEWCA1003</a>	\$498.01	94	
	12.4-18	0.3	1.3:1	Square Cover UG-1665/U	N Female	EAR99	<a href="#">PEWCA1097</a>	Call		95
					SMA Female	EAR99	<a href="#">PEWCA1098</a>	Call	96	
					N Female	EAR99	<a href="#">PEWCA1072</a>	\$849.00	97	
					SMA Female	EAR99	<a href="#">PEWCA1071</a>	\$750.00	98	
					SMA Female	EAR99	<a href="#">PE9803</a>	\$381.14	99	
					N Male	EAR99	<a href="#">PE9806</a>	\$619.41	1	
WR-75	10-15	1.25:1	Square Cover	N Female	EAR99	<a href="#">PE9866</a>	\$669.91		2	
				N Female	EAR99	<a href="#">PE9875</a>	\$360.83	3		
				SMA Female	EAR99	<a href="#">PE9846</a>	\$558.27	4		
				N Female	EAR99	<a href="#">PEWCA1005</a>	\$666.91	5		
				N Female	EAR99	<a href="#">PEWCA1029</a>	\$682.06		6	
				SMA Female	EAR99	<a href="#">PEWCA1004</a>	\$606.30			

Waveguides

# Waveguide to Coax Adapters



See Our Website For Current Pricing & Real-Time Stock Availability!

WG Type	RF Freq. (GHz.)	IL (dB)	Max VSWR	Flange Type	Connector	ECCN	Model No	1 Pc. Price	See Web for Volume Pricing	ROW	
WR-75	10-15	0.3	1.25:1	Square Cover	SMA Female	EAR99	<a href="#">PEWCA1024</a>	\$491.82	See Web for Volume Pricing	7	
	9.84-15	0.2		UBR120	N Female	EAR99	<a href="#">PEWCA1095</a>	Call		8	
					SMA Female	EAR99	<a href="#">PEWCA1096</a>	Call		9	
	10-15			1.3:1	Square Cover	N Female	EAR99	<a href="#">PEWCA1074</a>		\$819.77	10
						SMA Female	EAR99	<a href="#">PEWCA1073</a>		\$749.00	11
						N Female	EAR99	<a href="#">PE9874</a>		\$466.93	12
				1.4:1	Square Type	SMA Female	EAR99	<a href="#">PE9819</a>		\$368.09	13
						N Female	EAR99	<a href="#">PE9867</a>		\$679.08	14
						SMA Female	EAR99	<a href="#">PE9847</a>		\$626.60	15
	WR-90	8.2-12.4	0.25	1.25:1	CMR-90	N Female	EAR99	<a href="#">PEWCA1033</a>		\$767.96	16
						SMA Female	EAR99	<a href="#">PEWCA1032</a>		\$767.96	17
						N Female	EAR99	<a href="#">PEWCA1009</a>		\$562.97	18
N Female						EAR99	<a href="#">PEWCA1036</a>	\$692.89	19		
N Male						EAR99	<a href="#">PEWCA1035</a>	\$649.00	20		
SMA Female						EAR99	<a href="#">PEWCA1007</a>	\$523.27	21		
0.3			Square Cover UG-135/U		N Female	EAR99	<a href="#">PE9868</a>	\$769.00	22		
					N Female	EAR99	<a href="#">PEWCA1031</a>	\$776.04	23		
					N Female	EAR99	<a href="#">PEWCA1008</a>	\$650.21	24		
					SMA Female	EAR99	<a href="#">PEWCA1025</a>	\$498.01	25		
					SMA Female	EAR99	<a href="#">PEWCA1075</a>	\$759.00	26		
					SMA Male	EAR99	<a href="#">PEWCA1030</a>	\$664.66	27		
0.2		Square Cover UG-39/U	SMA Female	EAR99	<a href="#">PEWCA1006</a>	\$627.93	28				
			N Female	EAR99	<a href="#">PEWCA1092</a>	Call	29				
			SMA Female	EAR99	<a href="#">PEWCA1093</a>	Call	30				
			UDR100	N Female	EAR99	<a href="#">PE9883</a>	\$368.51	31			
			CPR-90G	N Female	EAR99	<a href="#">PE9873</a>	\$457.04	32			
			N Female	EAR99	<a href="#">PE9801</a>	\$379.39	33				
8.2-12.4		0.3	1.3:1	Square Type	N Male	EAR99	<a href="#">PE9889</a>	\$442.08	34		
					SMA Female	EAR99	<a href="#">PE9804</a>	\$359.58	35		
					SMA Male	EAR99	<a href="#">PE9810</a>	\$457.47	36		
					SMA Female	EAR99	<a href="#">PE9848</a>	\$562.88	37		
					SMA Male	EAR99	<a href="#">PE9869</a>	\$441.19	38		
					N Female	EAR99	<a href="#">PEWCA1038</a>	\$780.00	39		
WR-102	7-11	1.25:1	Square Cover UG-1493/U	N Male	EAR99	<a href="#">PEWCA1039</a>	\$780.00	40			
				SMA Female	EAR99	<a href="#">PE9805</a>	\$616.47	41			
				SMA Female	EAR99	<a href="#">PEWCA1037</a>	\$726.67	42			
				SMA Male	EAR99	<a href="#">PE9811</a>	\$325.83	43			
				N Female	EAR99	<a href="#">PE9802</a>	\$490.14	44			
				N Male	EAR99	<a href="#">PE9890</a>	\$449.00	45			
	7-11	1.3:1	Square Type	SMA Female	EAR99	<a href="#">PE9871</a>	\$435.56	46			
				SMA Female	EAR99	<a href="#">PEWCA1043</a>	\$685.67	47			
				SMA Female	EAR99	<a href="#">PEWCA1042</a>	\$659.93	48			
				N Female	EAR99	<a href="#">PEWCA1013</a>	\$548.80	49			
				N Female	EAR99	<a href="#">PEWCA1045</a>	\$700.12	50			
				SMA Female	EAR99	<a href="#">PEWCA1011</a>	\$641.88	51			
WR-112	7.05-10	1.25:1	CPR-112G	SMA Female	EAR99	<a href="#">PEWCA1044</a>	\$656.46	52			
				SMA Female	EAR99	<a href="#">PEWCA1041</a>	\$646.67	53			
				N Female	EAR99	<a href="#">PEWCA1012</a>	\$658.56	54			
				SMA Female	EAR99	<a href="#">PEWCA1040</a>	\$699.00	55			
				SMA Female	EAR99	<a href="#">PEWCA1010</a>	\$666.91	56			
				SMA Female	EAR99	<a href="#">PEWCA1089</a>	Call	57			
	6.57-9.99	0.2	1.3:1	Square Type	SMA Female	EAR99	<a href="#">PEWCA1090</a>	Call	58		
					UBR84	N Female	EAR99	<a href="#">PE9837</a>	\$591.88	59	
					CPR-112G	N Female	EAR99	<a href="#">PE9820</a>	\$385.50	60	
					N Female	EAR99	<a href="#">PE9870</a>	\$548.97	61		
					SMA Female	EAR99	<a href="#">PE9884</a>	\$347.06	62		
					SMA Female	EAR99	<a href="#">PE9865</a>	\$595.38	63		
WR-137	5.85-8.2	1.25:1	CMR-137	N Female	EAR99	<a href="#">PEWCA1049</a>	\$677.30	64			
				SMA Female	EAR99	<a href="#">PEWCA1048</a>	\$677.30	65			
				N Female	EAR99	<a href="#">PEWCA1017</a>	\$559.22	66			
				N Female	EAR99	<a href="#">PEWCA1051</a>	\$707.32	67			
				SMA Female	EAR99	<a href="#">PEWCA1015</a>	\$577.40	68			
				SMA Female	EAR99	<a href="#">PEWCA1050</a>	\$677.30	69			
	5.38-8.17	0.2	1.3:1	CPR-137G	N Female	EAR99	<a href="#">PEWCA1087</a>	Call	70		
					N Female	EAR99	<a href="#">PEWCA1016</a>	\$697.23	71		
					N Female	EAR99	<a href="#">PEWCA1047</a>	\$707.32	72		
					SMA Female	EAR99	<a href="#">PEWCA1014</a>	\$577.40	73		
					SMA Female	EAR99	<a href="#">PEWCA1046</a>	\$677.30	74		
					SMA Female	EAR99	<a href="#">PEWCA1086</a>	Call	75		
5.85-8.2	0.2	1.4:1	Round Cover UG-344/U	N Female	EAR99	<a href="#">PEWCA1016</a>	\$697.23	76			
				N Female	EAR99	<a href="#">PEWCA1047</a>	\$707.32	77			
5.38-8.17	0.2	1.4:1	Round Cover UG-441/U	SMA Female	EAR99	<a href="#">PEWCA1014</a>	\$577.40	78			
				SMA Female	EAR99	<a href="#">PEWCA1046</a>	\$677.30	79			
5.38-8.17	0.2	1.4:1	Round Cover UG-344/U	SMA Female	EAR99	<a href="#">PEWCA1014</a>	\$577.40	80			
				SMA Female	EAR99	<a href="#">PEWCA1046</a>	\$677.30	81			
5.38-8.17	0.2	1.4:1	Round Cover UG-441/U	SMA Female	EAR99	<a href="#">PEWCA1014</a>	\$577.40	82			
				SMA Female	EAR99	<a href="#">PEWCA1046</a>	\$677.30	83			
5.38-8.17	0.2	1.4:1	Round Cover UG-441/U	SMA Female	EAR99	<a href="#">PEWCA1014</a>	\$577.40	84			
				SMA Female	EAR99	<a href="#">PEWCA1046</a>	\$677.30	85			
5.38-8.17	0.2	1.4:1	Round Cover UG-441/U	SMA Female	EAR99	<a href="#">PEWCA1014</a>	\$577.40	86			
				SMA Female	EAR99	<a href="#">PEWCA1046</a>	\$677.30	87			

Waveguides



## Waveguide to Coax Adapters



WG Type	RF Freq. (GHz.)	IL (dB)	Max VSWR	Flange Type	Connector	ECCN	Model No	1 Pc. Price	See Web for Volume Pricing	ROW
WR-137	9.84-1.5	0.2	1.25:1	UDR70	SMA Female	EAR99	<a href="#">PEWCA1088</a>	Call	See Web for Volume Pricing	77
	5.85-8.2	0.4	1.3:1	CMR-137	N Female	EAR99	<a href="#">PE9876</a>	\$215.32		78
				CPR-137G	SMA Female	EAR99	<a href="#">PE9830</a>	\$531.11		79
WR-159	4.9-7.05	0.2	1.25:1	CMR-159	N Female	EAR99	<a href="#">PE9838</a>	\$349.97		80
				CPR-159G	N Female	EAR99	<a href="#">PEWCA1053</a>	\$623.40		81
				UDR58	SMA Female	EAR99	<a href="#">PEWCA1052</a>	\$671.89		82
	5.38-8.17	0.2	1.3:1	CPR-159G	N Female	EAR99	<a href="#">PEWCA1055</a>	\$623.40		83
				UDR58	SMA Female	EAR99	<a href="#">PEWCA1054</a>	\$646.67		84
				UDR58	SMA Female	EAR99	<a href="#">PEWCA1085</a>	Call		85
WR-187	3.95-5.85	0.2	1.25:1	CMR-159	N Female	EAR99	<a href="#">PE9821</a>	\$717.38		86
				CPR-159G	SMA Female	EAR99	<a href="#">PE9831</a>	\$673.53		87
				CPR-159G	N Female	EAR99	<a href="#">PE9839</a>	\$756.82		88
	3.94-5.99	0.2	1.25:1	CMR-187	N Female	EAR99	<a href="#">PEWCA1058</a>	\$538.38		89
				CPR-187G	SMA Female	EAR99	<a href="#">PEWCA1057</a>	\$620.71		90
				PDR48	N Female	EAR99	<a href="#">PEWCA1059</a>	\$538.38		91
3.95-5.85	0.2	1.3:1	Round Cover UG-407/U	N Female	EAR99	<a href="#">PEWCA1084</a>	Call	92		
			UDR48	N Female	EAR99	<a href="#">PEWCA1056</a>	\$656.81	93		
			UDR48	N Female	EAR99	<a href="#">PEWCA1083</a>	Call	94		
WR-229	3.95-5.85	0.2	1.3:1	CMR-187	N Female	EAR99	<a href="#">PE9822</a>	\$483.63		95
				CPR-187G	SMA Female	EAR99	<a href="#">PE9832</a>	\$816.17		96
				CPR-187G	N Female	EAR99	<a href="#">PE9840</a>	\$847.45	97	
	3.3-4.9	0.2	1.25:1	CMR-229	N Female	EAR99	<a href="#">PEWCA1060</a>	\$640.72	98	
				CPR-229G	N Female	EAR99	<a href="#">PEWCA1062</a>	\$640.72	99	
				CPR-229G	SMA Female	EAR99	<a href="#">PEWCA1061</a>	\$653.33	1	
WR-284	3.3-4.9	0.2	1.3:1	CMR-229	N Female	EAR99	<a href="#">PE9823</a>	\$619.87	2	
				CPR-229G	SMA Female	EAR99	<a href="#">PE9833</a>	\$661.78	3	
				CPR-229G	N Female	EAR99	<a href="#">PE9877</a>	\$901.09	4	
	2.6-3.95	0.2	1.25:1	CMR-284	N Female	EAR99	<a href="#">PEWCA1064</a>	\$720.38	5	
				CPR-284G	SMA Female	EAR99	<a href="#">PE9834</a>	\$1,302.50	6	
				Round Cover UG-584/U	N Female	EAR99	<a href="#">PEWCA1065</a>	\$773.33	7	
WR-340	2.2-3.3	0.2	1.3:1	UDR32	N Female	EAR99	<a href="#">PEWCA1063</a>	\$958.10	8	
				UDR32	N Female	EAR99	<a href="#">PEWCA1081</a>	Call	9	
				UDR32	SMA Female	EAR99	<a href="#">PEWCA1082</a>	Call	10	
	2.2-3.3	0.2	1.3:1	CMR-284	N Female	EAR99	<a href="#">PE9824</a>	\$808.48	11	
				CPR-284G	N Female	EAR99	<a href="#">PE9842</a>	\$529.00	12	
				CPR-340F	N Female	EAR99	<a href="#">PEWCA1066</a>	\$1,299.00	13	
WR-430	1.7-2.6	0.2	1.25:1	CPR-340G	N Female	EAR99	<a href="#">PEWCA1067</a>	\$1,299.00	14	
				CPR-430F	N Female	EAR99	<a href="#">PEWCA1068</a>	\$1,453.56	15	
				CPR-430G	N Female	EAR99	<a href="#">PEWCA1069</a>	\$1,499.00	16	
	1.72-2.61	0.3	1.3:1	UDR22	N Female	EAR99	<a href="#">PEWCA1079</a>	Call	17	
				UDR22	SMA Female	EAR99	<a href="#">PEWCA1080</a>	Call	18	
				CPR-430F	N Female	EAR99	<a href="#">PE9872</a>	\$1,299.79	19	
1.7-2.6	0.3	1.3:1	CPR-430F	SMA Female	EAR99	<a href="#">PE9835</a>	\$1,399.00	20		
			CPR-430G	N Female	EAR99	<a href="#">PE9843</a>	\$1,484.61	21		

## Corner Reflectors



Description	Model No	1	2-4	5-9	10+	ROW
1.4 inch Edge Length, Trihedral Corner Reflector, 1/4-20 Threaded Hole Mount, Aluminum Body, Gold Chem Film Finish	<a href="#">PEWRL0000</a>	\$875.00	\$844.38	\$813.75	\$787.50	22
1.8 inch Edge Length, Trihedral Corner Reflector, 1/4-20 Threaded Hole Mount, Aluminum Body, Gold Chem Film Finish	<a href="#">PEWRL0001</a>	\$962.50	\$928.81	\$895.13	\$866.25	23
2.4 inch Edge Length, Trihedral Corner Reflector, 1/4-20 Threaded Hole Mount, Aluminum Body, Gold Chem Film Finish	<a href="#">PEWRL0002</a>	\$1,050.00	\$1,013.25	\$976.50	\$945.00	24
3.2 inch Edge Length, Trihedral Corner Reflector, 1/4-20 Threaded Hole Mount, Aluminum Body, Gold Chem Film Finish	<a href="#">PEWRL0003</a>	\$1,450.00	\$1,399.25	\$1,348.50	\$1,305.00	25
4.3 inch Edge Length, Trihedral Corner Reflector, 1/4-20 Threaded Hole Mount, Aluminum Body, Gold Chem Film Finish	<a href="#">PEWRL0004</a>	\$1,450.00	\$1,399.25	\$1,348.50	\$1,305.00	26
6 inch Edge Length, Trihedral Corner Reflector, 1/4-20 Threaded Hole Mount, Aluminum Body, Gold Chem Film Finish	<a href="#">PEWRL0005</a>	\$1,725.00	\$1,664.63	\$1,604.25	\$1,552.50	27

See Our Website For Current Pricing & Real-Time Stock Availability!

Waveguides



Technical Support  
+1 (949) 261-1920



Same-Day Shipping,  
Even Custom  
Cable Assemblies

## Corner Reflectors

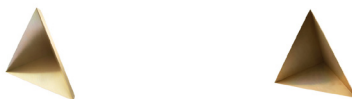

Description	Model No	1	2-4	5-9	10+	ROW
8 inch Edge Length, Trihedral Corner Reflector, 1/4-20 Threaded Hole Mount, Aluminum Body, Gold Chem Film Finish	<a href="#">PEWRL0006</a>	\$2,050.00	\$1,978.25	\$1,906.50	\$1,845.00	28
8.5 inch Edge Length, Trihedral Corner Reflector, 1/4-20 Threaded Hole Mount, Aluminum Body, Gold Chem Film Finish	<a href="#">PEWRL0007</a>	\$2,350.00	\$2,267.75	\$2,185.50	\$2,115.00	29
8.9 inch Edge Length, Trihedral Corner Reflector, 1/4-20 Threaded Hole Mount, Aluminum Body, Gold Chem Film Finish	<a href="#">PEWRL0008</a>	\$2,625.00	\$2,533.13	\$2,441.25	\$2,362.50	30
10 inch Edge Length, Trihedral Corner Reflector, 1/4-20 Threaded Hole Mount, Aluminum Body, Gold Chem Film Finish	<a href="#">PEWRL0009</a>	\$3,125.00	\$3,015.63	\$2,906.25	\$2,812.50	31
13 inch Edge Length, Trihedral Corner Reflector, 1/4-20 Threaded Hole Mount, Aluminum Body, Gold Chem Film Finish	<a href="#">PEWRL0010</a>	\$3,625.00	\$3,498.13	\$3,371.25	\$3,262.50	32
13.5 inch Edge Length, Trihedral Corner Reflector, 1/4-20 Threaded Hole Mount, Aluminum Body, Gold Chem Film Finish	<a href="#">PEWRL0011</a>	\$4,125.00	\$3,980.63	\$3,836.25	\$3,712.50	33
16 inch Edge Length, Trihedral Corner Reflector, 1/4-20 Threaded Hole Mount, Aluminum Body, Gold Chem Film Finish	<a href="#">PEWRL0012</a>	\$6,000.00	\$5,790.00	\$5,580.00	\$5,400.00	34
24 inch Edge Length, Trihedral Corner Reflector, 1/4-20 Threaded Hole Mount, Aluminum Body, Gold Chem Film Finish	<a href="#">PEWRL0013</a>	\$8,250.00	\$7,961.25	\$7,672.50	\$7,425.00	35

## WAVEGUIDE BANDPASS FILTERS



Waveguide Type	RF Frequency (GHz.)	Max VSWR	Flange Type	ECCN	Model No	1-9	10-24	25-49	50+	ROW
WR-28	30 - 31	1.4:1	Square Cover	EAR99	<a href="#">PE-W28F001</a>	\$390.41	\$370.89	\$351.37	\$335.75	36
	38 - 40	1.5:1		EAR99	<a href="#">PE-W28F002</a>	\$378.92	\$359.97	\$341.03	\$325.87	37
WR-42	20.2 - 21.2	1.5:1		EAR99	<a href="#">PE-W42F001</a>	\$382.46	\$363.34	\$344.21	\$328.92	38
	24.25 - 24.45	1.8:1		EAR99	<a href="#">PE-W42F002</a>	\$351.87	\$337.80	\$327.24	\$320.20	39
		1.5:1		EAR99	<a href="#">PE-W42F004</a>	\$368.10	\$349.70	\$331.29	\$316.57	40
	25.05 - 25.25	1.5:1		EAR99	<a href="#">PE-W42F003</a>	Call	Call	Call	Call	41

## WAVEGUIDE BENDS



Waveguide Type	RF Frequency (GHz.)	Insertion Loss (dB)	Bend Plane	Flange Type	ECCN	Model No	1 Pc. Price	See Web for Volume Pricing	ROW
WR-5	140 - 220		E-Bend	Round Cover UG-383/U-Mod	EAR99	<a href="#">PEW5B0000</a>	\$529.00	See Web for Volume Pricing	42
			H-Bend		EAR99	<a href="#">PEW5B0001</a>	\$529.00		43
WR-6	110 - 170	0.35	E-Bend		EAR99	<a href="#">PEW6B0000</a>	\$499.00		44
			H-Bend		EAR99	<a href="#">PEW6B0001</a>	\$499.00		45
WR-8	90 - 140	0.3	E-Bend		EAR99	<a href="#">PEW8B0000</a>	\$499.00		46
			H-Bend		EAR99	<a href="#">PEW8B0001</a>	\$499.00		47
WR-10	75 - 110	0.21	E-Bend		EAR99	<a href="#">PE-W10B001</a>	\$486.54		48
			H-Bend		EAR99	<a href="#">PE-W10B002</a>	\$486.54		49
WR-12	60 - 90		E-Bend		EAR99	<a href="#">PE-W12B001</a>	\$409.92		50
			H-Bend		EAR99	<a href="#">PE-W12B002</a>	\$398.43		51
WR-15	50 - 75	0.17	E-Bend	EAR99	<a href="#">PE-W15B001</a>	\$540.24	52		
			H-Bend	EAR99	<a href="#">PE-W15B002</a>	\$540.24	53		
WR-19	40 - 60	0.18	E-Bend	EAR99	<a href="#">PE-W19B001</a>	\$389.08	54		
			H-Bend	EAR99	<a href="#">PE-W19B002</a>	\$389.08	55		
WR-22	33 - 50	0.25	E-Bend	Round Cover UG-383/U	EAR99	<a href="#">PEW22B100</a>	\$374.50	56	
					EAR99	<a href="#">PEW22B001</a>	\$374.50	57	
WR-28	26.5 - 40	0.28	E-Bend	Square Cover UG-599/U	EAR99	<a href="#">PE-W28B001</a>	\$416.33	58	
					EAR99	<a href="#">PE-W28B002</a>	\$518.46	59	
WR-42	18 - 26.5	0.15	H-Bend	Square Cover UG-595/U	EAR99	<a href="#">PE-W28B003</a>	\$430.00	60	
					EAR99	<a href="#">PEW42B100</a>	\$400.70	61	
WR-51	15 - 22	0.09	E-Bend	UBR180	EAR99	<a href="#">PE-W51B001</a>	\$378.92	62	
									63

See Our Website For Current Pricing & Real-Time Stock Availability!

Waveguides

## WAVEGUIDE BENDS



Waveguide Type	RF Frequency (GHz.)	Insertion Loss (dB)	Bend Plane	Flange Type	ECCN	Model No	1 Pc. Price	See Web for Volume Pricing			ROW
WR-62	12.4 - 18	0.15	E-Bend	Square Cover UG-419/U	EAR99	<a href="#">PE-W62B001</a>	\$421.36				64
			H-Bend		EAR99	<a href="#">PE-W62B002</a>	\$421.36				65
			E-Bend		EAR99	<a href="#">PE-W62B003</a>	\$378.92				66
WR-75	10 - 15	0.09	H-Bend	UBR120	EAR99	<a href="#">PE-W62B004</a>	\$405.45				67
			E-Bend		EAR99	<a href="#">PE-W75B001</a>	\$427.79				68
WR-90	8.2 - 12.4	0.15	H-Bend	Square Cover UG-39/U	EAR99	<a href="#">PE-W75B002</a>	\$461.55				69
			E-Bend		EAR99	<a href="#">PE-W90B001</a>	\$392.11				70
WR-112	7.05 - 10	0.15	H-Bend	CPR-90G	EAR99	<a href="#">PE-W90B002</a>	\$400.89				71
			E-Bend		EAR99	<a href="#">PE-W90B003A</a>	\$399.00				72
WR-137	5.85 - 8.2	0.15	E-Bend	Square Cover UG-51/U	EAR99	<a href="#">PE-W112B001</a>	\$569.30				73
			H-Bend		EAR99	<a href="#">PE-W112B002</a>	\$490.05				74
WR-137	5.85 - 8.2	0.15	E-Bend	Round Cover UG-344/U	EAR99	<a href="#">PE-W137B001</a>	\$416.80				75
			H-Bend		EAR99	<a href="#">PE-W137B002</a>	\$433.06				76
			E-Bend			<a href="#">PE-W137B003A</a>	Call				77
			H-Bend		EAR99	<a href="#">PE-W137B004</a>	\$507.15				78

## WAVEGUIDE BULKHEAD ADAPTERS



Frequency Range (GHz.)	Waveguide Size	Flange 1	Flange 2	Model No	1 Pc. Price	See Web for Volume Pricing			ROW
75.0 - 110.0	WR-10	Round Cover UG-387/U-Mod	Round Cover UG-387/U-Mod	<a href="#">PEWAD5000</a>	\$1,029.00	See Web for Volume Pricing			79
60.0 - 90.0	WR-12	Round Cover UG-387/U	Round Cover UG-387/U	<a href="#">PEWAD5001</a>	\$930.85				80
50.0 - 75.0	WR-15	Round Cover UG-385/U	Round Cover UG-385/U	<a href="#">PEWAD5002</a>	\$930.85				81
40.0 - 60.0	WR-19	Round Cover UG-383/U-Mod	Round Cover UG-383/U-Mod	<a href="#">PEWAD5003</a>	\$930.85				82
33.0 - 50.0	WR-22	Round Cover UG-383/U	Round Cover UG-383/U	<a href="#">PEWAD5007</a>	\$850.98				83
			Round Cover UG-383/U	<a href="#">PEWAD5004</a>	\$930.85				84
26.5 - 40.0	WR-28	Square Cover UG-599/U	Square Cover UG-599/U	<a href="#">PEWAD5008</a>	\$743.29				85
			Square Cover UG-599/U	<a href="#">PEWAD5005</a>	\$1,042.56				86
22.0 - 33.0	WR-34	Square Cover UG-1530/U	Square Cover UG-1530/U	<a href="#">PEWAD5009</a>	\$757.20				87
18.0 - 26.5	WR-42	Square Cover UG-595/U	Square Cover UG-595/U	<a href="#">PEWAD5010</a>	\$778.04				88
			Square Cover UG-595/U	<a href="#">PEWAD5006</a>	\$1,042.56				89
15.0 - 22.0	WR-51	Square Cover	Square Cover	<a href="#">PEWAD5011</a>	\$791.92				90
12.4 - 18.0	WR-62	Square Cover UG-1665/U	Square Cover UG-1665/U	<a href="#">PEWAD5012</a>	\$826.65				91
10.0 - 15.0	WR-75	Square Cover	Square Cover	<a href="#">PEWAD5013</a>	\$850.98				92
8.2 - 12.4	WR-90	Square Cover UG-39/U	Square Cover UG-39/U	<a href="#">PEWAD5014</a>	\$882.24				93
		CPR-90G	CPR-90G	<a href="#">PEWAD5015</a>	\$882.24				94
7.05 - 10.0	WR-112	Square Cover UG-51/U	Square Cover UG-51/U	<a href="#">PEWAD5016</a>	\$930.85				95
		CPR-112G	CPR-112G	<a href="#">PEWAD5017</a>	\$930.85				96
5.85 - 8.2	WR-137	Square Cover UG-344/U	Square Cover UG-344/U	<a href="#">PEWAD5018</a>	\$979.48				97
		CPR-137G	CPR-137G	<a href="#">PEWAD5019</a>	\$979.48	98			

## WAVEGUIDE CONVERTER MIXERS

### Down Converter



RF/LO Frequency (GHz.)	IF Frequency (GHz.)	LO Power (dBm)	Typ Conv. Loss (dB)	RF & LO Waveguide Type	IF Connector	ECCN	Model No	1	2-4	5-9	10+	ROW
26.5 - 40	DC - 18	15	6	WR-28 UG-599/U	SMA Female	EAR99	<a href="#">PE12D1005</a>	\$3,686.78	\$3,539.31	\$3,391.84	\$3,244.37	99
33 - 50	DC - 18	15	7	WR-22 UG-383/U	SMA Female	EAR99	<a href="#">PE12D1004</a>	\$4,185.35	\$4,017.94	\$3,850.52	\$3,683.11	1
50 - 75	DC - 18	15	8	WR-15 UG-385/U	SMA Female	EAR99	<a href="#">PE12D1002</a>	\$4,522.88	\$4,341.96	\$4,161.05	\$3,980.13	2

Waveguides

### Down Converter



RF/LO Frequency (GHz.)	IF Frequency (GHz.)	LO Power (dBm)	Typ Conv. Loss (dB)	RF & LO Waveguide Type	IF Connector	ECCN	Model No	1	2-4	5-9	10+	ROW
60 - 90	DC - 18	15	9	WR-12 UG-387/U	SMA Female	EAR99	<a href="#">PE12D1001</a>	\$4,394.24	\$4,218.47	\$4,042.70	\$3,866.93	3
75 - 110	DC - 18	15	9	WR-10 UG-387/U-Mod	SMA Female	EAR99	<a href="#">PE12D1000</a>	\$6,178.38	\$5,931.24	\$5,684.11	\$5,436.97	4

### Up Converter



RF/LO Frequency (GHz.)	IF Frequency (GHz.)	LO Power (dBm)	Typ Conv. Loss (dB)	RF & LO Waveguide Type	IF Connector	ECCN	Model No	1	2-4	5-9	10+	ROW
26.5 - 40	DC - 18	15	6	WR-28 UG-599/U	SMA Female	EAR99	<a href="#">PE13U1005</a>	\$3,932.52	\$3,775.22	\$3,617.92	\$3,460.62	5
33 - 50	DC - 18	15	7	WR-22 UG-383/U	SMA Female	EAR99	<a href="#">PE13U1004</a>	\$4,759.15	\$4,568.78	\$4,378.42	\$4,188.05	6
40 - 60	DC - 18	15	7	WR-19 UG-383/U	SMA Female	EAR99	<a href="#">PE13U1003</a>	\$4,443.82	\$4,266.07	\$4,088.31	\$3,910.56	7
50 - 75	DC - 18	15	8	WR-15 UG-385/U	SMA Female	EAR99	<a href="#">PE13U1002</a>	\$5,062.93	\$4,860.41	\$4,657.90	\$4,455.38	8
60 - 90	DC - 18	15	9	WR-12 UG-387/U	SMA Female	EAR99	<a href="#">PE13U1001</a>	\$5,248.57	\$5,038.63	\$4,828.68	\$4,618.74	9
75 - 110	DC - 18	15	9	WR-10 UG-387/U	SMA Female	EAR99	<a href="#">PE13U1000</a>	\$5,285.82	\$5,074.39	\$4,862.95	\$4,651.52	10

## WAVEGUIDE COUPLERS

### Broadwall



WG Type	RF Freq. (GHz.)	IL (dB)	Max VSWR	Coupling (dB)	Directivity (dB)	Flange Type	ECCN	Model No	1	2-4	5-9	10+	ROW
WR-10	75 - 110	1.1	1.2:1	20	30	Round Cover UG-387/U-Mod	EAR99	<a href="#">PE-W10CP001-20</a>	\$2,344.50	\$2,250.72	\$2,156.94	\$2,063.16	11
				20	30		EAR99	<a href="#">PE-W10CP003-20</a>	\$2,564.15	\$2,461.58	\$2,359.02	\$2,256.45	12
				10	30		EAR99	<a href="#">PE-W10CP001-10</a>	\$2,344.50	\$2,250.72	\$2,156.94	\$2,063.16	13
		1.4		10	30	EAR99	<a href="#">PE-W10CP003-10</a>	\$2,564.15	\$2,461.58	\$2,359.02	\$2,256.45	14	
				20	40	EAR99	<a href="#">PEW10CP010-20</a>	\$2,467.90	\$2,369.18	\$2,270.47	\$2,171.75	15	
WR-12	60 - 90	1	1.2:1	20	30	Round Cover UG-387/U	EAR99	<a href="#">PE-W12CP001-20</a>	\$2,458.32	\$2,359.99	\$2,261.65	\$2,163.32	16
				20	30		EAR99	<a href="#">PE-W12CP003-20</a>	\$2,488.18	\$2,388.65	\$2,289.13	\$2,189.60	17
				10	30		EAR99	<a href="#">PE-W12CP001-10</a>	\$2,458.32	\$2,359.99	\$2,261.65	\$2,163.32	18
		1.4		10	30	EAR99	<a href="#">PE-W12CP003-10</a>	\$2,587.70	\$2,484.19	\$2,380.68	\$2,277.18	19	
				20	30	EAR99	<a href="#">PE-W15CP001-20</a>	\$2,431.19	\$2,333.94	\$2,236.69	\$2,139.45	20	
WR-15	50 - 75	1	1.2:1	20	30	Round Cover UG-385/U	EAR99	<a href="#">PE-W15CP003-20</a>	Call	Call	Call	Call	21
				10	30		EAR99	<a href="#">PE-W15CP001-10</a>	\$2,317.23	\$2,224.54	\$2,131.85	\$2,039.16	22
				10	30		EAR99	<a href="#">PE-W15CP003-10</a>	\$2,317.23	\$2,224.54	\$2,131.85	\$2,039.16	23
		1.4		10	30	EAR99	<a href="#">PE-W19CP003-10</a>	\$2,421.69	\$2,324.82	\$2,227.95	\$2,131.09	24	
				20	30	EAR99	<a href="#">PE-W19CP003-20</a>	\$2,374.21	\$2,279.24	\$2,184.27	\$2,089.30	25	
WR-19	40 - 60	0.8	1.2:1	20	30	Round Cover UG-383/U	EAR99	<a href="#">PE-W19CP001-20</a>	\$2,170.83	\$2,084.00	\$1,997.16	\$1,910.33	26
				20	30		EAR99	<a href="#">PE-W19CP001-10</a>	\$2,170.83	\$2,084.00	\$1,997.16	\$1,910.33	27
				10	30		EAR99	<a href="#">PEW22CP010-20</a>	\$2,230.50	\$2,141.28	\$2,052.06	\$1,962.84	28
		1		20	30	EAR99	<a href="#">PE-W22CP003-20</a>	\$2,409.93	\$2,313.53	\$2,217.14	\$2,120.74	29	
				10	30	EAR99	<a href="#">PE-W22CP001-10</a>	\$2,317.23	\$2,224.54	\$2,131.85	\$2,039.16	30	
WR-28	26.5 - 40	0.6	1.1:1	20	30	Square Cover UG-599/U	EAR99	<a href="#">PEW28CP010-20</a>	\$2,241.26	\$2,151.61	\$2,061.96	\$1,972.31	31
				20	30		EAR99	<a href="#">PE-W28CP003-20</a>	\$2,286.09	\$2,194.65	\$2,103.20	\$2,011.76	32
				10	30		EAR99	<a href="#">PE-W28CP002-10</a>	\$2,241.26	\$2,151.61	\$2,061.96	\$1,972.31	33
		1		10	30	EAR99	<a href="#">PE-W28CP003-10</a>	\$2,330.91	\$2,237.67	\$2,144.44	\$2,051.20	34	
				10	30	EAR99	<a href="#">PE-W28CP004-10</a>	Call	Call	Call	Call	35	
WR-34	22 - 33	1.05:1	1.05:1	20	35	Square Cover UG-1530/U	EAR99	<a href="#">PEWCP1006</a>	\$1,508.49	\$1,448.15	\$1,387.81	\$1,327.47	36
				30	35		EAR99	<a href="#">PEWCP1007</a>	\$1,508.49	\$1,448.15	\$1,387.81	\$1,327.47	37
				10	35		EAR99	<a href="#">PEWCP1005</a>	\$1,451.87	\$1,393.80	\$1,335.72	\$1,277.65	38

## Broadwall



WG Type	RF Freq. (GHz.)	IL (dB)	Max VSWR	Coupling (dB)	Directivity (dB)	Flange Type	ECCN	Model No	1	2-4	5-9	10+	ROW								
WR-42	18 - 26.5	0.6	1.2:1	20	30	Square Cover	EAR99	<a href="#">PE-W42CP002-20</a>	\$2,241.26	\$2,151.61	\$2,061.96	\$1,972.31	39								
				20	30		EAR99	<a href="#">PE-W42CP004-20</a>	\$2,330.91	\$2,237.67	\$2,144.44	\$2,051.20	40								
		1		10	30	UG-595/U	EAR99	<a href="#">PE-W42CP002-10</a>	\$2,157.13	\$2,070.84	\$1,984.56	\$1,898.27	41								
				10	30		EAR99	<a href="#">PE-W42CP004-10</a>	\$2,330.91	Call	Call	Call	42								
WR-51	15 - 22	0.15	1.05:1	10	35	Square Cover	EAR99	<a href="#">PEWCP1008</a>	\$1,479.62	\$1,420.44	\$1,361.25	\$1,302.07	43								
WR-62	12.4 - 18			20	35		EAR99	<a href="#">PEWCP1009</a>	\$1,479.62	\$1,420.44	\$1,361.25	\$1,302.07	44								
				30	35		EAR99	<a href="#">PEWCP1010</a>	\$1,538.80	\$1,477.25	\$1,415.70	\$1,354.14	45								
				10	40	Square Cover	EAR99	<a href="#">PEWCP1011</a>	\$1,320.82	\$1,267.99	\$1,215.15	\$1,162.32	46								
WR-75	10 - 15			20	40		EAR99	<a href="#">PEWCP1012</a>	\$1,373.65	\$1,318.70	\$1,263.76	\$1,208.81	47								
				30	40		EAR99	<a href="#">PEWCP1013</a>	\$1,373.65	\$1,318.70	\$1,263.76	\$1,208.81	48								
WR-90	8.2 - 12.4			0.15	1.05:1	10	40	Square Cover	EAR99	<a href="#">PEWCP1014</a>	\$1,292.08	\$1,240.40	\$1,188.71	\$1,137.03	49						
						20	40		EAR99	<a href="#">PEWCP1015</a>	\$1,292.08	\$1,240.40	\$1,188.71	\$1,137.03	50						
						WR-112	7.05 - 10	0.15	1.05:1	30	40	UG-39/U	EAR99	<a href="#">PEWCP1016</a>	\$1,396.18	\$1,340.33	\$1,284.49	\$1,228.64	51		
										10	40		EAR99	<a href="#">PEWCP1017</a>	\$1,546.31	\$1,484.46	\$1,422.61	\$1,360.75	52		
						WR-137	5.85 - 8.2	0.15	1.05:1	10	40	CPR-90G	EAR99	<a href="#">PEWCP1020</a>	\$1,437.96	\$1,380.44	\$1,322.92	\$1,265.40	53		
										20	40	Square Cover	EAR99	<a href="#">PEWCP1018</a>	\$1,486.84	\$1,427.37	\$1,367.89	\$1,308.42	54		
		20	40							CPR-90G	EAR99	<a href="#">PEWCP1021</a>	\$1,437.96	\$1,380.44	\$1,322.92	\$1,265.40	55				
		30	40							Square Cover	EAR99	<a href="#">PEWCP1019</a>	\$1,546.31	\$1,484.46	\$1,422.61	\$1,360.75	56				
		WR-112	7.05 - 10							0.15	1.05:1	30	40	CPR-90G	EAR99	<a href="#">PEWCP1022</a>	\$1,437.96	\$1,380.44	\$1,322.92	\$1,265.40	57
												10	40	Square Cover	EAR99	<a href="#">PEWCP1023A</a>	\$1,395.97	\$1,340.13	\$1,284.29	\$1,228.45	58
												10	40	CPR-112G	EAR99	<a href="#">PEWCP1026</a>	\$1,368.51	\$1,313.77	\$1,259.03	\$1,204.29	59
												20	40	Square Cover	EAR99	<a href="#">PEWCP1024</a>	\$1,319.88	\$1,267.08	\$1,214.29	\$1,161.49	60
20	40			CPR-112G	EAR99							<a href="#">PEWCP1027</a>	\$1,368.51	\$1,313.77	\$1,259.03	\$1,204.29	61				
30	40			Square Cover	EAR99							<a href="#">PEWCP1025</a>	\$1,371.36	\$1,316.51	\$1,261.65	\$1,206.80	62				
WR-137	5.85 - 8.2	0.15	1.05:1	30	40					CPR-112G	EAR99	<a href="#">PEWCP1028</a>	\$1,368.51	\$1,313.77	\$1,259.03	\$1,204.29	63				
				10	40					Round Cover	EAR99	<a href="#">PEWCP1029</a>	\$1,396.28	\$1,340.43	\$1,284.58	\$1,228.73	64				
				10	40	CPR-137G	EAR99	<a href="#">PEWCP1032</a>	\$1,444.92	\$1,387.12	\$1,329.33	\$1,271.53	65								
				20	40	Round Cover	EAR99	<a href="#">PEWCP1030</a>	\$1,396.28	\$1,340.43	\$1,284.58	\$1,228.73	66								
				20	40	CPR-137G	EAR99	<a href="#">PEWCP1033</a>	\$1,444.92	\$1,387.12	\$1,329.33	\$1,271.53	67								
				30	40	Round Cover	EAR99	<a href="#">PEWCP1031</a>	\$1,396.28	\$1,340.43	\$1,284.58	\$1,228.73	68								
30	40	CPR-137G	EAR99	<a href="#">PEWCP1034</a>	\$1,501.27	\$1,441.22	\$1,381.17	\$1,321.12	69												

## Crossguide\*



WG Type	RF Freq. (GHz.)	IL (dB)	Max VSWR	Coupling (dB)	Directivity (dB)	Flange Type	ECCN	Model No	1 Pc. Price	See Web for Volume Pricing	ROW
WR-34	22 - 33	0.1	1.05:1	20	20	Square Cover	EAR99	<a href="#">PEWCP1035</a>	\$977.51	See Web for Volume Pricing	70
				30	20		EAR99	<a href="#">PEWCP1036</a>	\$977.51		71
				40	25		EAR99	<a href="#">PEWCP1037</a>	\$977.51		72
				50	10		EAR99	<a href="#">PEWCP1038</a>	\$977.51		73
WR-42	18 - 26.5	0.1	1.05:1	20	30	Square Cover	EAR99	<a href="#">PEWCP1039</a>	\$779.03	See Web for Volume Pricing	74
				30	20		EAR99	<a href="#">PEWCP1040</a>	\$841.79		75
				40	20		EAR99	<a href="#">PEWCP1041</a>	\$779.03		76
WR-51	15 - 22	0.1	1.05:1	50	10	UG-595/U	EAR99	<a href="#">PEWCP1042</a>	\$841.79	See Web for Volume Pricing	77
				20	20		EAR99	<a href="#">PEWCP1043</a>	\$1,203.26		78
				30	30		EAR99	<a href="#">PEWCP1044</a>	\$1,203.26		79
				40	30		EAR99	<a href="#">PEWCP1045</a>	\$1,203.26		80
				50	10		EAR99	<a href="#">PEWCP1046</a>	\$1,203.26		81
				20	20		EAR99	<a href="#">PEWCP1047</a>	\$809.41		82
WR-62	12.4 - 18	0.1	1.05:1	30	10	Square Cover	EAR99	<a href="#">PEWCP1048</a>	\$809.41	See Web for Volume Pricing	83
				40	30		EAR99	<a href="#">PEWCP1049</a>	\$779.03		84
				50	10		EAR99	<a href="#">PEWCP1050</a>	\$779.03		85
WR-75	10 - 15	0.1	1.05:1	20	25	Square Cover	EAR99	<a href="#">PEWCP1051</a>	\$814.56	See Web for Volume Pricing	86
				30	25		EAR99	<a href="#">PEWCP1052A</a>	\$796.35		87
				40	15		EAR99	<a href="#">PEWCP1053</a>	\$814.56		88

\*These WG crossguide couplers are available as assemblies with termination and/or with WG to Coax Adapters, see WG Coupler Assemblies or visit our website

### Crossguide\*



WG Type	RF Freq. (GHz.)	IL (dB)	Max VSWR	Coupling (dB)	Directivity (dB)	Flange Type	ECCN	Model No	1-4	5-9	10-24	25+	ROW	
WR-75	10 - 15	0.1	1.05:1	50	10	Square Cover	EAR99	<a href="#">PEWCP1054</a>	\$783.98	\$744.78	\$705.58	\$674.22	89	
WR-90	8.2 - 12.4			20	20	Square Cover UG-39/U	EAR99	<a href="#">PEWCP1055</a>	\$793.93	\$754.23	\$714.54	\$682.78		90
				20	25	CPR-90G	EAR99	<a href="#">PEWCP1059</a>	\$818.71	\$777.77	\$736.84	\$704.09	91	
				30	20	Square Cover UG-39/U	EAR99	<a href="#">PEWCP1056</a>	\$764.13	\$725.92	\$687.72	\$657.15	92	
				30	20	CPR-90G	EAR99	<a href="#">PEWCP1060</a>	\$818.71	\$777.77	\$736.84	\$704.09	93	
				40	10	Square Cover UG-39/U	EAR99	<a href="#">PEWCP1057</a>	\$825.70	\$784.42	\$743.13	\$710.10	94	
				40	10	CPR-90G	EAR99	<a href="#">PEWCP1061</a>	\$818.71	\$777.77	\$736.84	\$704.09	95	
				50	10	Square Cover UG-39/U	EAR99	<a href="#">PEWCP1058</a>	\$825.70	\$784.42	\$743.13	\$710.10	96	
WR-112	7.05 - 10			50	10	CPR-90G	EAR99	<a href="#">PEWCP1062</a>	\$884.67	\$840.44	\$796.20	\$760.82	97	
				20	45	Square Cover UG-51/U	EAR99	<a href="#">PEWCP1063</a>	\$878.97	\$835.02	\$791.07	\$755.91	98	
				20	25	CPR-112G	EAR99	<a href="#">PEWCP1067</a>	\$888.18	\$843.77	\$799.36	\$763.83	99	
				30	25	Square Cover UG-51/U	EAR99	<a href="#">PEWCP1064</a>	\$913.25	\$867.59	\$821.93	\$785.40	1	
				30	25	CPR-112G	EAR99	<a href="#">PEWCP1068</a>	\$888.18	\$843.77	\$799.36	\$763.83	2	
		40	20	Square Cover UG-51/U	EAR99	<a href="#">PEWCP1065</a>	\$878.97	\$835.02	\$791.07	\$755.91	3			
		40	20	CPR-112G	EAR99	<a href="#">PEWCP1069</a>	\$888.18	\$843.77	\$799.36	\$763.83	4			
WR-137	5.85 - 8.2	50	10	Square Cover UG-51/U	EAR99	<a href="#">PEWCP1066</a>	\$949.79	\$902.30	\$854.81	\$816.82	5			
		50	10	CPR-112G	EAR99	<a href="#">PEWCP1070</a>	\$959.75	\$911.76	\$863.78	\$825.39	6			
		20	25	Round Cover UG-344/U	EAR99	<a href="#">PEWCP1071</a>	\$893.14	\$848.48	\$803.83	\$768.10	7			
		20	20	CPR-137G	EAR99	<a href="#">PEWCP1075</a>	\$853.46	\$810.79	\$768.11	\$733.98	8			
		30	20	Round Cover UG-344/U	EAR99	<a href="#">PEWCP1072</a>	\$893.14	\$848.48	\$803.83	\$768.10	9			
		30	20	CPR-137G	EAR99	<a href="#">PEWCP1076</a>	\$853.46	\$810.79	\$768.11	\$733.98	10			
		40	20	Round Cover UG-344/U	EAR99	<a href="#">PEWCP1073</a>	\$893.14	\$848.48	\$803.83	\$768.10	11			
		40	20	CPR-137G	EAR99	<a href="#">PEWCP1077</a>	\$853.46	\$810.79	\$768.11	\$733.98	12			
		50	10	Round Cover UG-344/U	EAR99	<a href="#">PEWCP1074</a>	\$893.14	\$848.48	\$803.83	\$768.10	13			
		50	10	CPR-137G	EAR99	<a href="#">PEWCP1078</a>	\$853.46	\$810.79	\$768.11	\$733.98	14			

### Crossguide\* with Termination



WG Type	RF Freq. (GHz.)	IL (dB)	Max VSWR	Coupling (dB)	Directivity (dB)	Flange Type	ECCN	Model No	1	2-4	5-9	10+	ROW
WR-34	22 - 33	0.1	1.05:1	20	20	Square Cover UG-1530/U	EAR99	<a href="#">PEWCT1000</a>	\$1,541.48	\$1,479.82	\$1,418.16	\$1,356.50	15
				30	20		EAR99	<a href="#">PEWCT1001</a>	\$1,541.48	\$1,479.82	\$1,418.16	\$1,356.50	16
				40	25		EAR99	<a href="#">PEWCT1002</a>	\$1,601.60	\$1,537.54	\$1,473.47	\$1,409.41	17
				50	10		EAR99	<a href="#">PEWCT1003</a>	\$1,541.48	\$1,479.82	\$1,418.16	\$1,356.50	18
WR-42	18 - 26.5			20	30	Square Cover UG-595/U	EAR99	<a href="#">PEWCT1004</a>	\$1,312.24	\$1,259.75	\$1,207.26	\$1,154.77	19
				30	20		EAR99	<a href="#">PEWCT1005</a>	\$1,312.24	\$1,259.75	\$1,207.26	\$1,154.77	20
				40	20		EAR99	<a href="#">PEWCT1006</a>	\$1,312.24	\$1,259.75	\$1,207.26	\$1,154.77	21
				50	10		EAR99	<a href="#">PEWCT1007</a>	\$1,312.24	\$1,259.75	\$1,207.26	\$1,154.77	22
WR-51	15 - 22			20	20	Square Cover	EAR99	<a href="#">PEWCT1008</a>	\$1,748.84	\$1,678.89	\$1,608.93	\$1,538.98	23
				30	30		EAR99	<a href="#">PEWCT1009</a>	\$1,748.84	\$1,678.89	\$1,608.93	\$1,538.98	24
				40	30		EAR99	<a href="#">PEWCT1010</a>	\$1,748.84	\$1,678.89	\$1,608.93	\$1,538.98	25
				50	10		EAR99	<a href="#">PEWCT1011</a>	\$1,748.84	\$1,678.89	\$1,608.93	\$1,538.98	26
WR-62	12.4 - 18			20	20	Square Cover UG-419/U	EAR99	<a href="#">PEWCT1012</a>	\$1,298.34	\$1,246.41	\$1,194.47	\$1,142.54	27
		30	10	EAR99	<a href="#">PEWCT1013</a>		\$1,348.98	\$1,295.02	\$1,241.06	\$1,187.10	28		
		40	30	EAR99	<a href="#">PEWCT1014</a>		\$1,298.34	\$1,246.41	\$1,194.47	\$1,142.54	29		
		50	10	EAR99	<a href="#">PEWCT1015</a>		\$1,298.34	\$1,246.41	\$1,194.47	\$1,142.54	30		
WR-75	10 - 15	20	25	Square Cover	EAR99	<a href="#">PEWCT1016</a>	\$1,357.63	\$1,303.32	\$1,249.02	\$1,194.71	31		
		30	25		EAR99	<a href="#">PEWCT1017</a>	\$1,306.67	\$1,254.40	\$1,202.14	\$1,149.87	32		
		40	15		EAR99	<a href="#">PEWCT1018</a>	\$1,306.67	\$1,254.40	\$1,202.14	\$1,149.87	33		
WR-90	8.2 - 12.4	50	10	EAR99	<a href="#">PEWCT1019</a>	\$1,357.63	\$1,303.32	\$1,249.02	\$1,194.71	34			
		20	20	Square Cover UG-39/U	EAR99	<a href="#">PEWCT1020</a>	\$1,276.81	\$1,225.74	\$1,174.67	\$1,123.59	35		
		20	25	CPR-90G	EAR99	<a href="#">PEWCT1024</a>	\$1,340.72	\$1,287.09	\$1,233.46	\$1,179.83	36		

\*These WG crossguide couplers are available as assemblies with termination and/or with WG to Coax Adapters, see WG Coupler Assemblies or visit our website

### Crossguide\* with Termination



WG Type	RF Freq. (GHz.)	IL (dB)	Max VSWR	Coupling (dB)	Directivity (dB)	Flange Type	ECCN	Model No	1	2-4	5-9	10+	ROW
WR-90	8.2 - 12.4	0.1	1.05:1	30	20	Square Cover UG-39/U	EAR99	<a href="#">PEWCT1021</a>	\$1,276.81	\$1,225.74	\$1,174.67	\$1,123.59	37
				30	20	CPR-90G	EAR99	<a href="#">PEWCT1025</a>	\$1,340.72	\$1,287.09	\$1,233.46	\$1,179.83	38
				40	10	Square Cover UG-39/U	EAR99	<a href="#">PEWCT1022</a>	\$1,276.81	\$1,225.74	\$1,174.67	\$1,123.59	39
				40	10	CPR-90G	EAR99	<a href="#">PEWCT1026</a>	\$1,340.72	\$1,287.09	\$1,233.46	\$1,179.83	40
				50	10	Square Cover UG-39/U	EAR99	<a href="#">PEWCT1023</a>	\$1,276.81	\$1,225.74	\$1,174.67	\$1,123.59	41
				50	10	CPR-90G	EAR99	<a href="#">PEWCT1027</a>	\$1,340.72	\$1,287.09	\$1,233.46	\$1,179.83	42
WR-112	7.05 - 10	0.1	1.05:1	20	45	Square Cover UG-51/U	EAR99	<a href="#">PEWCT1028</a>	\$1,424.08	\$1,367.12	\$1,310.15	\$1,253.19	43
				20	25	CPR-112G	EAR99	<a href="#">PEWCT1032</a>	\$1,440.05	\$1,382.45	\$1,324.85	\$1,267.24	44
				30	25	Square Cover UG-51/U	EAR99	<a href="#">PEWCT1029</a>	\$1,481.43	\$1,422.17	\$1,362.92	\$1,303.66	45
				30	25	CPR-112G	EAR99	<a href="#">PEWCT1033</a>	\$1,440.05	\$1,382.45	\$1,324.85	\$1,267.24	46
				40	20	Square Cover UG-51/U	EAR99	<a href="#">PEWCT1030</a>	\$1,425.82	\$1,368.79	\$1,311.75	\$1,254.72	47
				40	20	CPR-112G	EAR99	<a href="#">PEWCT1034</a>	\$1,440.05	\$1,382.45	\$1,324.85	\$1,267.24	48
				50	10	Square Cover UG-51/U	EAR99	<a href="#">PEWCT1031</a>	\$1,425.82	\$1,368.79	\$1,311.75	\$1,254.72	49
				50	10	CPR-112G	EAR99	<a href="#">PEWCT1035</a>	\$1,440.05	\$1,382.45	\$1,324.85	\$1,267.24	50
WR-137	5.85 - 8.2	0.1	1.05:1	20	25	Round Cover UG-344/U	EAR99	<a href="#">PEWCT1036</a>	\$1,469.22	\$1,410.45	\$1,351.68	\$1,292.91	51
				20	20	CPR-137G	EAR99	<a href="#">PEWCT1040</a>	\$1,433.80	\$1,376.45	\$1,319.10	\$1,261.74	52
				30	20	Round Cover UG-344/U	EAR99	<a href="#">PEWCT1037</a>	\$1,469.22	\$1,410.45	\$1,351.68	\$1,292.91	53
				30	20	CPR-137G	EAR99	<a href="#">PEWCT1041</a>	\$1,433.80	\$1,376.45	\$1,319.10	\$1,261.74	54
				40	20	Round Cover UG-344/U	EAR99	<a href="#">PEWCT1038</a>	\$1,469.22	\$1,410.45	\$1,351.68	\$1,292.91	55
				40	20	CPR-137G	EAR99	<a href="#">PEWCT1042</a>	\$1,433.80	\$1,376.45	\$1,319.10	\$1,261.74	56
				50	10	Round Cover UG-344/U	EAR99	<a href="#">PEWCT1039</a>	\$1,469.22	\$1,410.45	\$1,351.68	\$1,292.91	57
				50	10	CPR-137G	EAR99	<a href="#">PEWCT1043</a>	\$1,433.80	\$1,376.45	\$1,319.10	\$1,261.74	58

### Crossguide\* with Termination and WG to Coax Adapter



WG Type	RF Freq. (GHz.)	IL (dB)	Max VSWR	Coupling (dB)	Directivity (dB)	Flange Type	ECCN	Model No	1	2-4	5-9	10+	ROW
WR-34	22 - 33	0.1	1.05:1	20	20	Square Cover UG-1530/U	EAR99	<a href="#">PEWCT1044</a>	\$2,151.50	\$2,065.44	\$1,979.38	\$1,893.32	59
				30	20		EAR99	<a href="#">PEWCT1045</a>	\$2,151.50	\$2,065.44	\$1,979.38	\$1,893.32	60
				40	25		EAR99	<a href="#">PEWCT1046</a>	\$2,151.50	\$2,065.44	\$1,979.38	\$1,893.32	61
				50	10		EAR99	<a href="#">PEWCT1047</a>	\$2,151.50	\$2,065.44	\$1,979.38	\$1,893.32	62
WR-42	18 - 26.5	0.1	1.05:1	20	30	Square Cover UG-595/U	EAR99	<a href="#">PEWCT1048</a>	\$1,946.07	\$1,868.23	\$1,790.38	\$1,712.54	63
				30	20		EAR99	<a href="#">PEWCT1049</a>	\$1,946.07	\$1,868.23	\$1,790.38	\$1,712.54	64
				40	20		EAR99	<a href="#">PEWCT1050</a>	\$1,946.07	\$1,868.23	\$1,790.38	\$1,712.54	65
				50	10		EAR99	<a href="#">PEWCT1051</a>	\$1,946.07	\$1,868.23	\$1,790.38	\$1,712.54	66
WR-51	15 - 22	0.1	1.05:1	20	20	Square Cover	EAR99	<a href="#">PEWCT1052</a>	\$2,300.85	\$2,208.82	\$2,116.78	\$2,024.75	67
				30	30		EAR99	<a href="#">PEWCT1053</a>	\$2,300.85	\$2,208.82	\$2,116.78	\$2,024.75	68
				40	30		EAR99	<a href="#">PEWCT1054</a>	\$2,300.85	\$2,208.82	\$2,116.78	\$2,024.75	69
				50	10		EAR99	<a href="#">PEWCT1055</a>	\$2,300.85	\$2,208.82	\$2,116.78	\$2,024.75	70
WR-62	12.4 - 18	0.1	1.05:1	20	20	Square Cover UG-419/U	EAR99	<a href="#">PEWCT1056</a>	\$1,793.23	\$1,721.50	\$1,649.77	\$1,578.04	71
				30	10		EAR99	<a href="#">PEWCT1057</a>	\$1,937.69	\$1,860.18	\$1,782.67	\$1,705.17	72
				40	30		EAR99	<a href="#">PEWCT1058</a>	\$1,793.23	\$1,721.50	\$1,649.77	\$1,578.04	73
				50	10		EAR99	<a href="#">PEWCT1059</a>	\$1,793.23	\$1,721.50	\$1,649.77	\$1,578.04	74
WR-75	10 - 15	0.1	1.05:1	20	25	Square Cover	EAR99	<a href="#">PEWCT1060</a>	\$1,808.63	\$1,736.28	\$1,663.94	\$1,591.59	75
				20	25		EAR99	<a href="#">PEWCT1064</a>	\$1,857.24	\$1,782.95	\$1,708.66	\$1,634.37	76
				30	25		EAR99	<a href="#">PEWCT1061</a>	\$1,879.17	\$1,804.00	\$1,728.84	\$1,653.67	77
				30	25		EAR99	<a href="#">PEWCT1065</a>	\$1,857.24	\$1,782.95	\$1,708.66	\$1,634.37	78
				40	15		EAR99	<a href="#">PEWCT1062</a>	\$1,954.34	\$1,876.17	\$1,797.99	\$1,719.82	79
				40	15		EAR99	<a href="#">PEWCT1066</a>	\$2,006.86	\$1,926.59	\$1,846.31	\$1,766.04	80
				50	10		EAR99	<a href="#">PEWCT1063</a>	\$1,916.76	\$1,840.09	\$1,763.42	\$1,686.75	81
				50	10		EAR99	<a href="#">PEWCT1067</a>	\$1,857.24	\$1,782.95	\$1,708.66	\$1,634.37	82
WR-90	8.2 - 12.4	0.1	1.05:1	20	20	Square Cover UG-39/U	EAR99	<a href="#">PEWCT1068</a>	\$1,865.74	\$1,791.11	\$1,716.48	\$1,641.85	83

\*These WG crossguide couplers are available as assemblies with termination and/or with WG to Coax Adapters, see WG Coupler Assemblies or visit our website

## Crossguide\* with Termination and WG to Coax Adapter



WG Type	RF Freq. (GHz.)	IL (dB)	Max VSWR	Coupling (dB)	Directivity (dB)	Flange Type	ECCN	Model No	1	2-4	5-9	10+	R O W
WR-90	8.2 - 12.4			20	25	CPR-90G	EAR99	<a href="#">PEWCT1072</a>	\$1,860.71	\$1,786.28	\$1,711.85	\$1,637.42	84
				20	20	Square Cover UG-39/U	EAR99	<a href="#">PEWCT1076</a>	\$1,981.66	\$1,902.39	\$1,823.13	\$1,743.86	85
				20	25	CPR-90G	EAR99	<a href="#">PEWCT1080</a>	\$1,898.92	\$1,822.96	\$1,747.01	\$1,671.05	86
				30	20	Square Cover UG-39/U	EAR99	<a href="#">PEWCT1069</a>	\$1,865.74	\$1,791.11	\$1,716.48	\$1,641.85	87
				30	20	CPR-90G	EAR99	<a href="#">PEWCT1073</a>	\$1,860.71	\$1,786.28	\$1,711.85	\$1,637.42	88
				30	20	Square Cover UG-39/U	EAR99	<a href="#">PEWCT1077</a>	\$1,833.92	\$1,760.56	\$1,687.21	\$1,613.85	89
				30	20	CPR-90G	EAR99	<a href="#">PEWCT1081</a>	\$1,898.92	\$1,822.96	\$1,747.01	\$1,671.05	90
				40	10	Square Cover UG-39/U	EAR99	<a href="#">PEWCT1070</a>	\$1,795.71	\$1,723.88	\$1,652.05	\$1,580.22	91
				40	10	CPR-90G	EAR99	<a href="#">PEWCT1074</a>	\$1,860.71	\$1,786.28	\$1,711.85	\$1,637.42	92
				40	10	Square Cover UG-39/U	EAR99	<a href="#">PEWCT1078</a>	\$1,905.44	\$1,829.22	\$1,753.00	\$1,676.79	93
				40	10	CPR-90G	EAR99	<a href="#">PEWCT1082</a>	\$1,898.92	\$1,822.96	\$1,747.01	\$1,671.05	94
				50	10	Square Cover UG-39/U	EAR99	<a href="#">PEWCT1071</a>	\$1,795.71	\$1,723.88	\$1,652.05	\$1,580.22	95
				50	10	CPR-90G	EAR99	<a href="#">PEWCT1075</a>	\$1,860.71	\$1,786.28	\$1,711.85	\$1,637.42	96
				50	10	Square Cover UG-39/U	EAR99	<a href="#">PEWCT1079</a>	\$1,905.44	\$1,829.22	\$1,753.00	\$1,676.79	97
				50	10	CPR-90G	EAR99	<a href="#">PEWCT1083</a>	\$1,898.92	\$1,822.96	\$1,747.01	\$1,671.05	98
WR-112	7.05 - 10	0.1	1.05:1	20	45	Square Cover UG-51/U	EAR99	<a href="#">PEWCT1084</a>	\$2,053.63	\$1,971.48	\$1,889.34	\$1,807.19	99
				20	25	CPR-112G	EAR99	<a href="#">PEWCT1088</a>	\$1,992.70	\$1,912.99	\$1,833.28	\$1,753.58	1
				20	45	Square Cover UG-51/U	EAR99	<a href="#">PEWCT1092</a>	\$1,990.44	\$1,910.82	\$1,831.20	\$1,751.59	2
				20	25	CPR-112G	EAR99	<a href="#">PEWCT1096</a>	\$2,006.61	\$1,926.35	\$1,846.08	\$1,765.82	3
				30	25	Square Cover UG-51/U	EAR99	<a href="#">PEWCT1085</a>	\$1,976.54	\$1,897.48	\$1,818.42	\$1,739.36	4
				30	25	CPR-112G	EAR99	<a href="#">PEWCT1089</a>	\$1,992.70	\$1,912.99	\$1,833.28	\$1,753.58	5
				30	25	Square Cover UG-51/U	EAR99	<a href="#">PEWCT1093</a>	\$1,990.44	\$1,910.82	\$1,831.20	\$1,751.59	6
				30	25	CPR-112G	EAR99	<a href="#">PEWCT1097</a>	\$2,006.61	\$1,926.35	\$1,846.08	\$1,765.82	7
				40	20	Square Cover UG-51/U	EAR99	<a href="#">PEWCT1086</a>	\$1,976.54	\$1,897.48	\$1,818.42	\$1,739.36	8
				40	20	CPR-112G	EAR99	<a href="#">PEWCT1090</a>	\$1,992.70	\$1,912.99	\$1,833.28	\$1,753.58	9
				40	20	Square Cover UG-51/U	EAR99	<a href="#">PEWCT1094</a>	\$1,990.44	\$1,910.82	\$1,831.20	\$1,751.59	10
				40	20	CPR-112G	EAR99	<a href="#">PEWCT1098</a>	\$2,006.61	\$1,926.35	\$1,846.08	\$1,765.82	11
				50	10	Square Cover UG-51/U	EAR99	<a href="#">PEWCT1087</a>	\$1,976.54	\$1,897.48	\$1,818.42	\$1,739.36	12
				50	10	CPR-112G	EAR99	<a href="#">PEWCT1091</a>	\$1,992.70	\$1,912.99	\$1,833.28	\$1,753.58	13
				50	10	Square Cover UG-51/U	EAR99	<a href="#">PEWCT1095</a>	\$1,990.44	\$1,910.82	\$1,831.20	\$1,751.59	14
50	10	CPR-112G	EAR99	<a href="#">PEWCT1099</a>	\$2,168.27	\$2,081.54	\$1,994.81	\$1,908.08	15				
WR-137	5.85 - 8.2			20	25	Round Cover UG-344/U	EAR99	<a href="#">PEWCT1100</a>	\$2,042.81	\$1,961.10	\$1,879.39	\$1,797.67	16
				20	20	CPR-137G	EAR99	<a href="#">PEWCT1104</a>	\$2,006.59	\$1,926.33	\$1,846.06	\$1,765.80	17
				20	25	Round Cover UG-344/U	EAR99	<a href="#">PEWCT1108</a>	\$2,046.30	\$1,964.45	\$1,882.60	\$1,800.74	18
				20	20	CPR-137G	EAR99	<a href="#">PEWCT1112</a>	\$2,010.08	\$1,929.68	\$1,849.27	\$1,768.87	19
				30	20	Round Cover UG-344/U	EAR99	<a href="#">PEWCT1101</a>	\$2,042.81	\$1,961.10	\$1,879.39	\$1,797.67	20
				30	20	CPR-137G	EAR99	<a href="#">PEWCT1105</a>	\$2,006.59	\$1,926.33	\$1,846.06	\$1,765.80	21
				30	20	Round Cover UG-344/U	EAR99	<a href="#">PEWCT1109</a>	\$2,046.30	\$1,964.45	\$1,882.60	\$1,800.74	22
				30	20	CPR-137G	EAR99	<a href="#">PEWCT1113</a>	\$2,010.08	\$1,929.68	\$1,849.27	\$1,768.87	23
				40	20	Round Cover UG-344/U	EAR99	<a href="#">PEWCT1102</a>	\$2,042.81	\$1,961.10	\$1,879.39	\$1,797.67	24
				40	20	CPR-137G	EAR99	<a href="#">PEWCT1106</a>	\$2,006.59	\$1,926.33	\$1,846.06	\$1,765.80	25
				40	20	Round Cover UG-344/U	EAR99	<a href="#">PEWCT1110</a>	\$2,126.11	\$2,041.07	\$1,956.02	\$1,870.98	26
				40	20	CPR-137G	EAR99	<a href="#">PEWCT1114</a>	\$2,172.02	\$2,085.14	\$1,998.26	\$1,911.38	27
				50	10	Round Cover UG-344/U	EAR99	<a href="#">PEWCT1103</a>	\$2,042.81	\$1,961.10	\$1,879.39	\$1,797.67	28
				50	10	CPR-137G	EAR99	<a href="#">PEWCT1107</a>	\$2,006.59	\$1,926.33	\$1,846.06	\$1,765.80	29
				50	10	Round Cover UG-344/U	EAR99	<a href="#">PEWCT1111</a>	\$2,046.30	\$1,964.45	\$1,882.60	\$1,800.74	30
50	10	CPR-137G	EAR99	<a href="#">PEWCT1115</a>	\$2,010.08	\$1,929.68	\$1,849.27	\$1,768.87	31				

\*These WG crossguide couplers are available as assemblies with termination and/or with WG to Coax Adapters, see WG Coupler Assemblies or visit our website



## WAVEGUIDE COUPLER ASSEMBLIES

See Our Website For Current Pricing & Real-Time Stock Availability!

WG Crossguide Coupler	WG Crossguide Coupler with Termination	WG Crossguide Coupler with Termination & Coax Adapter SMA/ Type N	Conn. Type
<a href="#">PEWCP1035</a>	<a href="#">PEWCT1000</a>	<a href="#">PEWCT1044</a>	2.92mm
<a href="#">PEWCP1036</a>	<a href="#">PEWCT1001</a>	<a href="#">PEWCT1045</a>	2.92mm
<a href="#">PEWCP1037</a>	<a href="#">PEWCT1002</a>	<a href="#">PEWCT1046</a>	2.92mm
<a href="#">PEWCP1038</a>	<a href="#">PEWCT1003</a>	<a href="#">PEWCT1047</a>	2.92mm
<a href="#">PEWCP1039</a>	<a href="#">PEWCT1004</a>	<a href="#">PEWCT1048</a>	SMA
<a href="#">PEWCP1040</a>	<a href="#">PEWCT1005</a>	<a href="#">PEWCT1049</a>	SMA
<a href="#">PEWCP1041</a>	<a href="#">PEWCT1006</a>	<a href="#">PEWCT1050</a>	SMA
<a href="#">PEWCP1042</a>	<a href="#">PEWCT1007</a>	<a href="#">PEWCT1051</a>	SMA
<a href="#">PEWCP1043</a>	<a href="#">PEWCT1008</a>	<a href="#">PEWCT1052</a>	SMA
<a href="#">PEWCP1044</a>	<a href="#">PEWCT1009</a>	<a href="#">PEWCT1053</a>	SMA
<a href="#">PEWCP1045</a>	<a href="#">PEWCT1010</a>	<a href="#">PEWCT1054</a>	SMA
<a href="#">PEWCP1046</a>	<a href="#">PEWCT1011</a>	<a href="#">PEWCT1055</a>	SMA
<a href="#">PEWCP1047</a>	<a href="#">PEWCT1012</a>	<a href="#">PEWCT1056</a>	SMA
<a href="#">PEWCP1048</a>	<a href="#">PEWCT1013</a>	<a href="#">PEWCT1057</a>	SMA
<a href="#">PEWCP1049</a>	<a href="#">PEWCT1014</a>	<a href="#">PEWCT1058</a>	SMA
<a href="#">PEWCP1050</a>	<a href="#">PEWCT1015</a>	<a href="#">PEWCT1059</a>	SMA
<a href="#">PEWCP1051</a>	<a href="#">PEWCT1016</a>	<a href="#">PEWCT1060</a>	SMA
		<a href="#">PEWCT1064</a>	N
<a href="#">PEWCP1052</a>	<a href="#">PEWCT1017</a>	<a href="#">PEWCT1061</a>	SMA
		<a href="#">PEWCT1065</a>	N
<a href="#">PEWCP1053</a>	<a href="#">PEWCT1018</a>	<a href="#">PEWCT1062</a>	SMA
		<a href="#">PEWCT1066</a>	N
<a href="#">PEWCP1054</a>	<a href="#">PEWCT1019</a>	<a href="#">PEWCT1063</a>	SMA
		<a href="#">PEWCT1067</a>	N
<a href="#">PEWCP1055</a>	<a href="#">PEWCT1020</a>	<a href="#">PEWCT1068</a>	SMA
		<a href="#">PEWCT1076</a>	N
<a href="#">PEWCP1056</a>	<a href="#">PEWCT1021</a>	<a href="#">PEWCT1069</a>	SMA
		<a href="#">PEWCT1077</a>	N
<a href="#">PEWCP1057</a>	<a href="#">PEWCT1022</a>	<a href="#">PEWCT1070</a>	SMA
		<a href="#">PEWCT1078</a>	N
<a href="#">PEWCP1058</a>	<a href="#">PEWCT1023</a>	<a href="#">PEWCT1071</a>	SMA
		<a href="#">PEWCT1079</a>	N
<a href="#">PEWCP1059</a>	<a href="#">PEWCT1024</a>	<a href="#">PEWCT1072</a>	SMA
		<a href="#">PEWCT1080</a>	N
<a href="#">PEWCP1060</a>	<a href="#">PEWCT1025</a>	<a href="#">PEWCT1073</a>	SMA
		<a href="#">PEWCT1081</a>	N

WG Crossguide Coupler	WG Crossguide Coupler with Termination	WG Crossguide Coupler with Termination & Coax Adapter SMA/ Type N	Conn. Type
<a href="#">PEWCP1061</a>	<a href="#">PEWCT1026</a>	<a href="#">PEWCT1074</a>	SMA
		<a href="#">PEWCT1082</a>	N
<a href="#">PEWCP1062</a>	<a href="#">PEWCT1027</a>	<a href="#">PEWCT1075</a>	SMA
		<a href="#">PEWCT1083</a>	N
<a href="#">PEWCP1063</a>	<a href="#">PEWCT1028</a>	<a href="#">PEWCT1084</a>	SMA
		<a href="#">PEWCT1092</a>	N
<a href="#">PEWCP1064</a>	<a href="#">PEWCT1029</a>	<a href="#">PEWCT1085</a>	SMA
		<a href="#">PEWCT1093</a>	N
<a href="#">PEWCP1065</a>	<a href="#">PEWCT1030</a>	<a href="#">PEWCT1086</a>	SMA
		<a href="#">PEWCT1094</a>	N
<a href="#">PEWCP1066</a>	<a href="#">PEWCT1031</a>	<a href="#">PEWCT1087</a>	SMA
		<a href="#">PEWCT1095</a>	N
<a href="#">PEWCP1067</a>	<a href="#">PEWCT1032</a>	<a href="#">PEWCT1088</a>	SMA
		<a href="#">PEWCT1096</a>	N
<a href="#">PEWCP1068</a>	<a href="#">PEWCT1033</a>	<a href="#">PEWCT1089</a>	SMA
		<a href="#">PEWCT1097</a>	N
<a href="#">PEWCP1069</a>	<a href="#">PEWCT1034</a>	<a href="#">PEWCT1090</a>	SMA
		<a href="#">PEWCT1098</a>	N
<a href="#">PEWCP1070</a>	<a href="#">PEWCT1035</a>	<a href="#">PEWCT1091</a>	SMA
		<a href="#">PEWCT1099</a>	N
<a href="#">PEWCP1071</a>	<a href="#">PEWCT1036</a>	<a href="#">PEWCT1100</a>	SMA
		<a href="#">PEWCT1108</a>	N
<a href="#">PEWCP1072</a>	<a href="#">PEWCT1037</a>	<a href="#">PEWCT1101</a>	SMA
		<a href="#">PEWCT1109</a>	N
<a href="#">PEWCP1073</a>	<a href="#">PEWCT1038</a>	<a href="#">PEWCT1102</a>	SMA
		<a href="#">PEWCT1110</a>	N
<a href="#">PEWCP1074</a>	<a href="#">PEWCT1039</a>	<a href="#">PEWCT1103</a>	SMA
		<a href="#">PEWCT1111</a>	N
<a href="#">PEWCP1075</a>	<a href="#">PEWCT1040</a>	<a href="#">PEWCT1104</a>	SMA
		<a href="#">PEWCT1112</a>	N
<a href="#">PEWCP1076</a>	<a href="#">PEWCT1041</a>	<a href="#">PEWCT1105</a>	SMA
		<a href="#">PEWCT1113</a>	N
<a href="#">PEWCP1077</a>	<a href="#">PEWCT1042</a>	<a href="#">PEWCT1106</a>	SMA
		<a href="#">PEWCT1114</a>	N
<a href="#">PEWCP1078</a>	<a href="#">PEWCT1043</a>	<a href="#">PEWCT1107</a>	SMA
		<a href="#">PEWCT1115</a>	N

## WAVEGUIDE DETECTORS



Connector 1	RF Frequency (GHz.)	Voltage Sensitivity (V/nW)	Input Power (dBm)	Connector 2	ECCN	Model No	1	2-4	5-9	10+	R O W
<a href="#">WR-28 UG-599/U</a>	26.5 - 40	-1,000	20	SMA Female	EAR99	<a href="#">PE80T3005</a>	\$3,356.18	\$3,221.93	\$3,087.69	\$2,953.44	32
<a href="#">WR-22 UG-383/U</a>	33 - 50	-800		SMA Female	EAR99	<a href="#">PE80T3004</a>	\$4,110.42	\$3,966.56	\$3,822.69	\$3,699.38	33
<a href="#">WR-19 UG-383/U</a>	40 - 60	-800		SMA Female	EAR99	<a href="#">PE80T3003</a>	\$3,629.29	\$3,484.12	\$3,338.95	\$3,193.78	34
<a href="#">WR-15 UG-385/U</a>	50 - 75	-700		SMA Female	EAR99	<a href="#">PE80T3002</a>	\$3,806.56	\$3,654.30	\$3,502.04	\$3,349.77	35
<a href="#">WR-12 UG-387/U</a>	60 - 90	-900		SMA Female	EAR99	<a href="#">PE80T3001</a>	\$4,112.40	\$3,947.90	\$3,783.41	\$3,618.91	36
<a href="#">WR-10 UG-387/U</a>	75 - 100	-900		SMA Female	EAR99	<a href="#">PE80T3000</a>	\$3,470.82	\$3,331.99	\$3,193.15	\$3,054.32	37

Waveguides



Technical Support  
+1 (949) 261-1920



Same-Day Shipping,  
Even Custom Cable Assemblies

## WAVEGUIDE DIRECT READ ATTENUATORS



WG Type	RF Freq. (GHz.)	Max Atten (dB)	IL (dB)	Max VSWR	Input Power (Watts)	Flange Type	ECCN	Model No	1	2-4	5-9	10+	ROW
WR-10	75 - 110	50	1	1.2:1	0.2	Round Cover UG-387/U-Mod	EAR99	<a href="#">PE-W10AT5001</a>	\$5,198.54	\$4,990.60	\$4,782.66	\$4,574.72	38
WR-12	60 - 90		0.9	1.2:1	0.2	Round Cover UG-387/U	EAR99	<a href="#">PE-W12AT5001</a>	\$5,617.33	\$5,420.72	\$5,224.12	\$5,055.60	39
WR-15	50 - 75		0.8	1.2:1	0.3	Round Cover UG-385/U	EAR99	<a href="#">PE-W15AT5001</a>	\$5,401.28	\$5,185.23	\$4,969.18	\$4,753.13	40
WR-19	40 - 60		0.7	1.15:1	0.2	Round Cover UG-383/U-Mod	EAR99	<a href="#">PE-W19AT5001</a>	\$5,198.54	\$4,990.60	\$4,782.66	\$4,574.72	41
WR-22	33 - 50		0.6	1.15:1	0.4	Round Cover UG-383/U	EAR99	<a href="#">PE-W22AT5001</a>	\$5,401.28	\$5,185.23	\$4,969.18	\$4,753.13	42
			1.15:1	0.5	EAR99		<a href="#">PE-W22AT5002</a>	\$5,200.00	\$4,992.00	\$4,784.00	\$4,576.00	43	
WR-28	26.5 - 40	50	0.5	1.15:1	0.5	Square Cover UG-599/U	EAR99	<a href="#">PE-W28AT5001</a>	\$5,401.28	\$5,185.23	\$4,969.18	\$4,753.13	44
WR-42	18 - 26.5					Square Cover UG-595/U	EAR99	<a href="#">PE-W42AT5001</a>	\$5,617.33	\$5,392.64	\$5,167.94	\$4,943.25	45

## WAVEGUIDE ELECTROMECHANICAL RELAY SWITCHES



**Features:**  
 A: Absorptive  
 AR: Auto Reset  
 F: Failsafe  
 D: Diode  
 GR: Global Reset  
 H: Hot Switches  
 I: Indicators  
 L: Latching  
 N: Normally Open  
 NT: Non-Terminated  
 P: Pulse  
 R: Reflective  
 RS: Reset  
 S: Self Cut Off  
 SI: Set Indicator  
 T: Terminated  
 Latching  
 TTL: TTL Logic  
 V: Viewing Window

WG Type	Switch Type	RF Freq. (GHz.)	Actuator / Features	IL (dB)	Iso (dB)	DC Power (V)	ECCN	Model No	1	2-4	5-9	10+	ROW	
WR-28	SPDT	26.5 - 40	B, L, S, I, M	0.15	55	12	EAR99	<a href="#">PEWGS6002</a>	\$3,518.57	\$3,377.83	\$3,237.08	\$3,096.34	46	
				0.15	55	28	EAR99	<a href="#">PEWGS6000</a>	\$3,490.70	\$3,351.07	\$3,211.44	\$3,071.82	47	
				0.15	55	12	EAR99	<a href="#">PEWGS6003</a>	\$3,983.33	\$3,824.00	\$3,664.66	\$3,505.33	48	
			B, L, TTL, S, I, M	0.15	55	28	EAR99	<a href="#">PEWGS6001</a>	\$3,626.84	\$3,481.77	\$3,336.69	\$3,191.62	49	
WR-34	SPDT/DPDT	22 - 33		L, S, SI, M, V	0.15	60	12	EAR99	<a href="#">PEWGS6042</a>	\$4,316.67	\$4,144.00	\$3,971.34	\$3,798.67	50
					0.15	60	28	EAR99	<a href="#">PEWGS6040</a>	\$4,316.67	\$4,144.00	\$3,971.34	\$3,798.67	51
			0.15		60	12	EAR99	<a href="#">PEWGS6043</a>	\$4,483.33	\$4,304.00	\$4,124.66	\$3,945.33	52	
			M, V	0.15	60	28	EAR99	<a href="#">PEWGS6041</a>	\$4,483.33	\$4,304.00	\$4,124.66	\$3,945.33	53	
WR-42		18 - 26.5		B, L, S, I, M	0.15	60	12	EAR99	<a href="#">PEWGS6006</a>	\$3,518.57	\$3,377.83	\$3,237.08	\$3,096.34	54
					0.15	60	28	EAR99	<a href="#">PEWGS6004</a>	\$3,490.70	\$3,351.07	\$3,211.44	\$3,071.82	55
			0.15		60	12	EAR99	<a href="#">PEWGS6007</a>	\$3,518.57	\$3,377.83	\$3,237.08	\$3,096.34	56	
			B, L, TTL, S, I, M	0.15	60	28	EAR99	<a href="#">PEWGS6005</a>	\$3,626.84	\$3,481.77	\$3,336.69	\$3,191.62	57	
WR-62	SPDT	12.4 - 18		B, L, S, I, M	0.1	60	12	EAR99	<a href="#">PEWGS6010</a>	\$3,386.50	\$3,251.04	\$3,115.58	\$2,980.12	58
					0.1	60	28	EAR99	<a href="#">PEWGS6008</a>	\$3,490.70	\$3,351.07	\$3,211.44	\$3,071.82	59
			0.1		60	12	EAR99	<a href="#">PEWGS6011</a>	\$3,386.50	\$3,251.04	\$3,115.58	\$2,980.12	60	
			B, L, TTL, S, I, M	0.1	60	28	EAR99	<a href="#">PEWGS6009</a>	\$4,077.29	\$3,914.20	\$3,751.11	\$3,588.02	61	
WR-75		10 - 15		B, L, S, I, M	0.05	75	12	EAR99	<a href="#">PEWGS6014</a>	\$3,386.50	\$3,251.04	\$3,115.58	\$2,980.12	62
					0.05	75	28	EAR99	<a href="#">PEWGS6012</a>	\$3,626.84	\$3,481.77	\$3,336.69	\$3,191.62	63
			0.05		75	12	EAR99	<a href="#">PEWGS6015</a>	\$3,386.50	\$3,251.04	\$3,115.58	\$2,980.12	64	
			B, L, TTL, S, I, M	0.05	75	28	EAR99	<a href="#">PEWGS6013</a>	\$3,951.63	\$3,793.56	\$3,635.50	\$3,477.43	65	
WR-90		8.2 - 12.4		B, L, S, I, M	0.07	80	12	EAR99	<a href="#">PEWGS6018</a>	\$3,518.57	\$3,377.83	\$3,237.08	\$3,096.34	66
					0.07	80	28	EAR99	<a href="#">PEWGS6016</a>	\$3,626.84	\$3,481.77	\$3,336.69	\$3,191.62	67
			0.07		80	12	EAR99	<a href="#">PEWGS6019</a>	\$4,138.68	\$3,973.13	\$3,807.59	\$3,642.04	68	
			B, L, TTL, S, I, M	0.07	80	28	EAR99	<a href="#">PEWGS6017</a>	\$3,626.84	\$3,481.77	\$3,336.69	\$3,191.62	69	
WR-102	SPDT/DPDT	7 - 11		L, S, SI, M, V	0.06	80	12	EAR99	<a href="#">PEWGS6038</a>	\$4,316.67	\$4,144.00	\$3,971.34	\$3,798.67	70
					0.06	80	28	EAR99	<a href="#">PEWGS6036</a>	\$4,316.67	\$4,144.00	\$3,971.34	\$3,798.67	71
			0.06		80	12	EAR99	<a href="#">PEWGS6039</a>	\$4,483.33	\$4,304.00	\$4,124.66	\$3,945.33	72	
			M, V	0.06	80	28	EAR99	<a href="#">PEWGS6037</a>	\$4,483.33	\$4,304.00	\$4,124.66	\$3,945.33	73	
WR-112	SPDT	7.05 - 10		B, L, S, I, M	0.05	80	12	EAR99	<a href="#">PEWGS6022</a>	\$3,386.50	\$3,251.04	\$3,115.58	\$2,980.12	74
					0.05	80	28	EAR99	<a href="#">PEWGS6020</a>	\$3,490.70	\$3,351.07	\$3,211.44	\$3,071.82	75
			0.05		80	12	EAR99	<a href="#">PEWGS6023</a>	\$3,518.57	\$3,377.83	\$3,237.08	\$3,096.34	76	
			B, L, TTL, S, I, M	0.05	80	28	EAR99	<a href="#">PEWGS6021</a>	\$3,490.70	\$3,351.07	\$3,211.44	\$3,071.82	77	
WR-137		5.85 - 8.2		B, L, S, I, M	0.02	70	12	EAR99	<a href="#">PEWGS6026</a>	\$3,386.50	\$3,251.04	\$3,115.58	\$2,980.12	78
					0.02	70	28	EAR99	<a href="#">PEWGS6024</a>	\$3,626.84	\$3,481.77	\$3,336.69	\$3,191.62	79
			0.02		70	12	EAR99	<a href="#">PEWGS6027</a>	\$3,386.50	\$3,251.04	\$3,115.58	\$2,980.12	80	
			B, L, TTL, S, I, M	0.02	70	28	EAR99	<a href="#">PEWGS6025</a>	\$3,490.70	\$3,351.07	\$3,211.44	\$3,071.82	81	
WR-159	SPDT/DPDT	4.9 - 7.05		L, S, SI, M, V	0.06	70	12	EAR99	<a href="#">PEWGS6034</a>	\$4,316.67	\$4,144.00	\$3,971.34	\$3,798.67	82
					0.06	70	28	EAR99	<a href="#">PEWGS6032</a>	\$4,316.67	\$4,144.00	\$3,971.34	\$3,798.67	83
			0.06		70	12	EAR99	<a href="#">PEWGS6033</a>	\$4,483.33	\$4,304.00	\$4,124.66	\$3,945.33	84	
			M, V	0.06	70	28	EAR99	<a href="#">PEWGS6035</a>	\$4,483.33	\$4,304.00	\$4,124.66	\$3,945.33	85	
WR-187		3.95 - 5.85		L, S, SI, M, V	0.02	80	12	EAR99	<a href="#">PEWGS6030</a>	\$4,316.67	\$4,144.00	\$3,971.34	\$3,798.67	86
					0.02	80	28	EAR99	<a href="#">PEWGS6028</a>	\$4,316.37	\$4,143.72	\$3,971.06	\$3,798.41	87
			0.002		80	12	EAR99	<a href="#">PEWGS6031</a>	\$4,483.33	\$4,304.00	\$4,124.66	\$3,945.33	88	
			M, V	0.02	80	28	EAR99	<a href="#">PEWGS6029</a>	\$4,483.33	\$4,304.00	\$4,124.66	\$3,945.33	89	

# DOUBLE RIDGE WAVEGUIDE ELECTROMECHANICAL RELAY SWITCHES



**Features:**  
 A: Absorptive  
 AR: Auto Reset  
 F: Failsafe  
 D: Diode  
 GR: Global Reset  
 H: Hot Switches  
 I: Indicators  
 L: Latching  
 N: Normally Open  
 NT: Non-Terminated  
 P: Pulse  
 Latching  
 R: Reflective  
 RS: Reset  
 S: Self Cut Off  
 SI: Set Indicator  
 T: Terminated  
 TTL: TTL Logic  
 V: Viewing Window

WG Type	Switch Type	RF Freq. (GHz.)	Actuator / Features	IL (dB)	Iso (dB)	DC Power (V)	ECCN	Model No	1	2-4	5-9	10+	ROW	
WRD-180	SPDT/DPDT	18 - 40	L, S, SI, M, V	0.4	50	12	EAR99	<a href="#">PEWGS6054</a>	\$8,483.33	\$8,144.00	\$7,804.66	\$7,465.33	90	
				0.4	50	28	EAR99	<a href="#">PEWGS6052</a>	\$8,483.33	\$8,144.00	\$7,804.66	\$7,465.33	91	
			L, TTL, S, SI, M, V	0.4	50	12	EAR99	<a href="#">PEWGS6055</a>	\$8,650.00	\$8,304.00	\$7,958.00	\$7,612.00	92	
WRD-650		L, S, SI, M, V	6.5 - 18	L, S, SI, M, V	0.4	50	28	EAR99	<a href="#">PEWGS6053</a>	\$8,650.00	\$8,304.00	\$7,958.00	\$7,612.00	93
					0.35	60	12	EAR99	<a href="#">PEWGS6046</a>	\$7,650.00	\$7,344.00	\$7,038.00	\$6,732.00	94
		L, TTL, S, SI, M, V		0.35	60	28	EAR99	<a href="#">PEWGS6044</a>	\$7,650.00	\$7,344.00	\$7,038.00	\$6,732.00	95	
WRD-750	L, S, SI, M, V	7.5 - 18	L, S, SI, M, V	0.35	60	12	EAR99	<a href="#">PEWGS6047</a>	\$7,816.67	\$7,504.00	\$7,191.34	\$6,878.67	96	
				0.35	60	28	EAR99	<a href="#">PEWGS6045</a>	\$7,816.67	\$7,504.00	\$7,191.34	\$6,878.67	97	
	L, TTL, S, SI, M, V		0.3	60	12	EAR99	<a href="#">PEWGS6050</a>	\$7,650.00	\$7,344.00	\$7,038.00	\$6,732.00	98		
	L, S, SI, M, V	L, S, SI, M, V	L, S, SI, M, V	0.3	60	28	EAR99	<a href="#">PEWGS6048</a>	\$7,650.00	\$7,344.00	\$7,038.00	\$6,732.00	99	
				L, TTL, S, SI, M, V	0.3	60	12	EAR99	<a href="#">PEWGS6051</a>	\$7,816.67	\$7,504.00	\$7,191.34	\$6,878.67	1
	L, TTL, S, SI, M, V	0.3	60	28	EAR99	<a href="#">PEWGS6049</a>	\$7,816.67	\$7,504.00	\$7,191.34	\$6,878.67	2			

## ELECTROMECHANICAL RELAY SWITCHES see page 288

## FLEXIBLE WAVEGUIDES

Seamless



Waveguide Type	RF Frequency (GHz.)	IL (dB)	Max VSWR	Length (in)	Flange Type	ECCN	Model No	1	2-4	5-9	10+	ROW
WR-22	33 - 50	0.49	1.2:1	6	Round Cover UG-383/U	EAR99	<a href="#">PE-W22SF005-6</a>	\$1,638.39	\$1,572.85	\$1,507.32	\$1,441.78	3
		0.49	1.2:1	12	Round Cover UG-383/U	EAR99	<a href="#">PE-W22SF005-12</a>	\$2,493.85	\$2,394.10	\$2,294.34	\$2,194.59	4
		0.49	1.2:1	24	Round Cover UG-383/U	EAR99	<a href="#">PE-W22SF005-24</a>	\$3,313.56	\$3,181.02	\$3,048.48	\$2,915.93	5
WR-28	26.5 - 40	0.49	1.2:1	12	Square Cover UG-599/U	EAR99	<a href="#">PE-W28SF005-12</a>	\$1,388.67	\$1,333.12	\$1,277.58	\$1,222.03	6
		0.98	1.2:1	24	Square Cover UG-599/U	EAR99	<a href="#">PE-W28SF005-24</a>	\$2,208.58	\$2,120.24	\$2,031.89	\$1,943.55	7
		1.47	1.2:1	36	Square Cover UG-599/U	EAR99	<a href="#">PE-W28SF005-36</a>	\$3,081.92	\$2,958.64	\$2,835.37	\$2,712.09	8
WR-34	22 - 33	0.4	1.15:1	12	Square Cover UG-1530/U	EAR99	<a href="#">PE-W34SF005-12</a>	\$1,335.25	\$1,281.84	\$1,228.43	\$1,175.02	9
		0.8	1.15:1	24	Square Cover UG-1530/U	EAR99	<a href="#">PE-W34SF005-24</a>	\$2,125.68	\$2,040.65	\$1,955.63	\$1,870.60	10
		1.2	1.15:1	36	Square Cover UG-1530/U	EAR99	<a href="#">PE-W34SF005-36</a>	\$3,081.92	\$2,958.64	\$2,835.37	\$2,712.09	11
WR-42	18 - 26.5	0.27	1.15:1	12	Square Cover UG-595/U	EAR99	<a href="#">PE-W42SF005-12</a>	\$1,172.85	\$1,125.94	\$1,079.02	\$1,032.11	12
		0.54	1.15:1	24	Square Cover UG-595/U	EAR99	<a href="#">PE-W42SF005-24</a>	\$1,905.44	\$1,829.22	\$1,753.00	\$1,676.79	13
		0.81	1.15:1	36	Square Cover UG-595/U	EAR99	<a href="#">PE-W42SF005-36</a>	\$2,641.64	\$2,535.97	\$2,430.31	\$2,324.64	14
WR-51	15 - 22	0.18	1.1:1	12	Square Cover	EAR99	<a href="#">PE-W51SF005-12</a>	\$1,139.25	\$1,093.68	\$1,048.11	\$1,002.54	15
		0.36	1.1:1	24	Square Cover	EAR99	<a href="#">PE-W51SF005-24</a>	\$1,840.88	\$1,767.24	\$1,693.61	\$1,619.97	16
		0.54	1.1:1	36	Square Cover	EAR99	<a href="#">PE-W51SF005-36</a>	\$2,549.44	\$2,447.46	\$2,345.48	\$2,243.51	17
WR-62	12.4 - 18	0.14	1.08:1	12	Square Cover UG-419/U	EAR99	<a href="#">PE-W62SF005-12</a>	\$1,125.94	\$1,080.90	\$1,035.86	\$990.83	18
		0.28	1.08:1	24	Square Cover UG-419/U	EAR99	<a href="#">PE-W62SF005-24</a>	\$1,625.52	\$1,560.50	\$1,495.48	\$1,430.46	19
		0.42	1.08:1	36	Square Cover UG-419/U	EAR99	<a href="#">PE-W62SF005-36</a>	\$2,348.47	\$2,254.53	\$2,160.59	\$2,066.65	20
WR-75	10 - 15	0.12	1.07:1	12	Square Cover	EAR99	<a href="#">PE-W75SF005-12</a>	\$1,100.70	\$1,056.67	\$1,012.64	\$968.62	21
		0.24	1.07:1	24	Square Cover	EAR99	<a href="#">PE-W75SF005-24</a>	\$1,779.00	\$1,707.84	\$1,636.68	\$1,565.52	22
		0.36	1.07:1	36	Square Cover	EAR99	<a href="#">PE-W75SF005-36</a>	\$2,417.04	\$2,320.36	\$2,223.68	\$2,127.00	23
WR-90	8.2 - 12.4	0.09	1.07:1	12	Square Cover UG-39/U	EAR99	<a href="#">PE-W90SF005-12</a>	\$1,170.98	\$1,124.14	\$1,077.30	\$1,030.46	24
		0.18	1.07:1	24	CPR-90G	EAR99	<a href="#">PE-W90SF006-24</a>	\$1,695.00	\$1,627.20	\$1,559.40	\$1,491.60	25
		0.18	1.07:1	24	Square Cover UG-39/U	EAR99	<a href="#">PE-W90SF005-24</a>	\$1,761.11	\$1,690.67	\$1,620.22	\$1,549.78	26
		0.27	1.07:1	36	CPR-90G	EAR99	<a href="#">PE-W90SF006-36</a>	\$2,299.36	\$2,207.39	\$2,115.41	\$2,023.44	27
		0.27	1.07:1	36	Square Cover UG-39/U	EAR99	<a href="#">PE-W90SF005-36</a>	\$2,389.04	\$2,293.48	\$2,197.92	\$2,102.36	28
		0.9	1.07:1	36	CPR-90G	EAR99	<a href="#">PE-W90SF006-12</a>	\$1,083.68	\$1,040.33	\$996.99	\$953.64	29
WR-112	7.05 - 10	0.08	1.07:1	12	CPR-112G	EAR99	<a href="#">PE-W112SF006-12</a>	\$1,174.00	\$1,127.04	\$1,080.08	\$1,033.12	30
		0.08	1.07:1	24	Square Cover UG-51/U	EAR99	<a href="#">PE-W112SF005-12</a>	\$1,174.00	\$1,127.04	\$1,080.08	\$1,033.12	31
		0.16	1.07:1	24	CPR-112G	EAR99	<a href="#">PE-W112SF006-24</a>	\$1,847.81	\$1,773.90	\$1,699.99	\$1,626.07	32
		0.16	1.07:1	24	Square Cover UG-51/U	EAR99	<a href="#">PE-W112SF005-24</a>	\$1,847.81	\$1,773.90	\$1,699.99	\$1,626.07	33
		0.24	1.07:1	36	CPR-112G	EAR99	<a href="#">PE-W112SF006-36</a>	\$2,528.60	\$2,427.46	\$2,326.31	\$2,225.17	34
		0.24	1.07:1	36	Square Cover UG-51/U	EAR99	<a href="#">PE-W112SF005-36</a>	\$2,528.60	\$2,427.46	\$2,326.31	\$2,225.17	35
WR-137	5.85 - 8.2	0.06	1.07:1	12	CPR-137G	EAR99	<a href="#">PE-W137SF006-12</a>	\$1,201.77	\$1,153.70	\$1,105.63	\$1,057.56	36
		0.06	1.07:1	24	Round Cover UG-344/U	EAR99	<a href="#">PE-W137SF005-12</a>	\$1,305.97	\$1,253.73	\$1,201.49	\$1,149.25	37
		0.12	1.07:1	24	CPR-137G	EAR99	<a href="#">PE-W137SF006-24</a>	\$2,031.90	\$1,950.62	\$1,869.35	\$1,788.07	38
		0.12	1.07:1	24	Round Cover UG-344/U	EAR99	<a href="#">PE-W137SF005-24</a>	\$2,077.05	\$1,993.97	\$1,910.89	\$1,827.80	39
		0.18	1.07:1	36	CPR-137G	EAR99	<a href="#">PE-W137SF006-36</a>	\$2,799.52	\$2,687.54	\$2,575.56	\$2,463.58	40
		0.18	1.07:1	36	Round Cover UG-344/U	EAR99	<a href="#">PE-W137SF005-36</a>	\$2,848.13	\$2,734.20	\$2,620.28	\$2,506.35	41

See Our Website For Current Pricing & Real-Time Stock Availability!

Waveguides



Technical Support  
+1 (949) 261-1920



Same-Day Shipping,  
Even Custom  
Cable Assemblies

### Twistable



Waveguide Type	RF Frequency (GHz.)	IL (dB)	Max VSWR	Length (in)	Flange Type	ECCN	Model No	1 Pc. Price	See Web for Volume Pricing	R O W
WR-22	33 - 50	0.6	1.3:1	6	Round Cover UG-383/U	EAR99	<a href="#">PE-W22TF005-6</a>	\$822.80	See Web for Volume Pricing	42
		0.6	1.3:1	12	Round Cover UG-383/U	EAR99	<a href="#">PE-W22TF005-12</a>	\$837.24		43
		0.6	1.3:1	24	Round Cover UG-383/U	EAR99	<a href="#">PE-W22TF005-24</a>	\$880.54		44
WR-28	26.5 - 40	0.6	1.3:1	12	Square Cover UG-599/U	EAR99	<a href="#">PE-W28TF005-12</a>	\$542.15		45
		1.2	1.3:1	24	Square Cover UG-599/U	EAR99	<a href="#">PE-W28TF005-24</a>	\$586.72		46
		1.8	1.3:1	36	Square Cover UG-599/U	EAR99	<a href="#">PE-W28TF005-36</a>	\$593.32		47
WR-34	22 - 33	0.5	1.22:1	12	Square Cover UG-1530/U	EAR99	<a href="#">PE-W34TF005-12</a>	\$504.00		48
		1	1.22:1	24	Square Cover UG-1530/U	EAR99	<a href="#">PE-W34TF005-24</a>	\$567.46		49
		1.5	1.22:1	36	Square Cover UG-1530/U	EAR99	<a href="#">PE-W34TF005-36</a>	\$607.42		50
WR-42	18 - 26.5	0.35	1.3:1	12	Square Cover UG-595/U	EAR99	<a href="#">PE-W42TF005-12</a>	\$466.51		51
		0.7	1.3:1	24	Square Cover UG-595/U	EAR99	<a href="#">PE-W42TF005-24</a>	\$495.53		52
		1.05	1.35:1	36	Square Cover UG-595/U	EAR99	<a href="#">PE-W42TF005-36</a>	\$518.46		53
WR-51	15 - 22	0.55	1.15:1	12	Square Cover	EAR99	<a href="#">PE-W51TF005-12</a>	\$492.80	54	
		1.1	1.15:1	24	Square Cover	EAR99	<a href="#">PE-W51TF005-24</a>	\$512.45	55	
		1.65	1.15:1	36	Square Cover	EAR99	<a href="#">PE-W51TF005-36</a>	\$570.41	56	
WR-62	12.4 - 18	0.28	1.1:1	12	Square Cover UG-419/U	EAR99	<a href="#">PE-W62TF005-12</a>	\$549.63	57	
		0.56	1.1:1	24	Square Cover UG-419/U	EAR99	<a href="#">PE-W62TF005-24</a>	\$582.40	58	
		0.84	1.1:1	36	Square Cover UG-419/U	EAR99	<a href="#">PE-W62TF005-36</a>	\$653.53	59	
WR-75	10 - 15	0.18	1.1:1	12	Square Cover	EAR99	<a href="#">PE-W75TF005-12</a>	\$602.38	60	
		0.36	1.1:1	24	Square Cover	EAR99	<a href="#">PE-W75TF005-24</a>	\$599.43	61	
		0.54	1.1:1	36	Square Cover	EAR99	<a href="#">PE-W75TF005-36</a>	\$674.31	62	
WR-90	8.2 - 12.4	0.15	1.07:1	12	CPR-90G	EAR99	<a href="#">PE-W90TF006-12</a>	\$512.45	63	
		0.15	1.1:1		Square Cover UG-39/U	EAR99	<a href="#">PE-W90TF005-12</a>	\$567.46	64	
		0.3	1.07:1	24	CPR-90G	EAR99	<a href="#">PE-W90TF006-24</a>	\$622.36	65	
		0.36	1.1:1		Square Cover UG-39/U	EAR99	<a href="#">PE-W90TF005-24</a>	\$695.09	66	
		0.45	1.07:1	36	CPR-90G	EAR99	<a href="#">PE-W90TF006-36</a>	\$683.09	67	
		0.45	1.1:1		Square Cover UG-39/U	EAR99	<a href="#">PE-W90TF005-36</a>	\$710.41	68	
WR-112	7.05 - 10	0.12	1.07:1	12	CPR-112G	EAR99	<a href="#">PE-W112TF006-12</a>	\$647.38	69	
		0.12	1.3:1		Square Cover UG-51/U	EAR99	<a href="#">PE-W112TF005-12</a>	\$668.69	70	
		0.24	1.07:1	24	CPR-112G	EAR99	<a href="#">PE-W112TF006-24</a>	\$726.02	71	
		0.24	1.07:1		Square Cover UG-51/U	EAR99	<a href="#">PE-W112TF005-24</a>	\$683.08	72	
		0.36	1.07:1	36	CPR-112G	EAR99	<a href="#">PE-W112TF006-36</a>	\$758.14	73	
		0.36	1.07:1		Square Cover UG-51/U	EAR99	<a href="#">PE-W112TF005-36</a>	\$758.14	74	
WR-137	5.85 - 8.2	0.07	1.05:1	12	CPR-137G	EAR99	<a href="#">PE-W137TF006-12</a>	\$622.36	75	
		0.07	1.05:1		Round Cover UG-344/U	EAR99	<a href="#">PE-W137TF005-12</a>	\$632.16	76	
		0.14	1.05:1	24	CPR-137G	EAR99	<a href="#">PE-W137TF006-24</a>	\$710.41	77	
		0.14	1.05:1		Round Cover UG-344/U	EAR99	<a href="#">PE-W137TF005-24</a>	\$778.21	78	
		0.18	1.05:1	36	Round Cover UG-344/U	EAR99	<a href="#">PE-W137TF005-36</a>	\$878.25	79	
		0.21	1.05:1		CPR-137G	EAR99	<a href="#">PE-W137TF006-36</a>	\$809.38	80	

### WAVEGUIDE ISOLATORS



WG Type	RF Freq. (GHz.)	Isolation (dB)	IL (dB)	VSWR	Flange Type	ECCN	Model No	1	2-4	5-9	10+	R O W
WR-10	75 - 110	25	2.3	1.5:1	UG-387/U-Mod		<a href="#">PEWIR1000</a>	\$2,616.36	\$2,511.71	\$2,407.05	\$2,302.40	81
WR-12	60 - 90		2	1.5:1	UG-387/U		<a href="#">PEWIR1001</a>	\$2,699.00	\$2,591.04	\$2,483.08	\$2,375.12	82
WR-15	50 - 75		1.8	1.4:1	UG-385/U		<a href="#">PEWIR1002</a>	\$2,599.00	\$2,495.04	\$2,391.08	\$2,287.12	83
WR-19	40 - 60		1.6	1.4:1	UG-383/U-Mod		<a href="#">PEWIR1003</a>	\$2,699.00	\$2,591.04	\$2,483.08	\$2,375.12	84
WR-22	33 - 50		1.5	1.4:1	UG-383/U		<a href="#">PEWIR1004</a>	\$2,651.82	\$2,545.75	\$2,439.67	\$2,333.60	85
WR-28	26.5 - 40		1.2	1.4:1	UG-383/U		<a href="#">PEWIR1014</a>	Call	Call	Call	Call	86
					UG-599/U		<a href="#">PEWIR1005</a>	Call	Call	Call	Call	87
					UG-599/U		<a href="#">PEWIR1011</a>	Call	Call	Call	Call	88
		25	1	1.3:1	UG-599/U		<a href="#">PEWIR1015</a>	\$2,899.00	\$2,783.04	\$2,667.08	\$2,551.12	89
WR-42	18 - 26.5	18	0.4	1.3:1	UG-597/U		<a href="#">PEWIR1010</a>	\$2,415.36	\$2,318.75	\$2,222.13	\$2,125.52	90
WR-62	12.4 - 18	18	0.4	1.3:1	UG-1665/U		<a href="#">PEWIR1009</a>	\$2,308.03	\$2,215.71	\$2,123.39	\$2,031.07	91
WR-75	10 - 15	18	0.5				<a href="#">PEWIR1008</a>	\$2,260.10	\$2,169.70	\$2,079.29	\$1,988.89	92
WR-90	8.2 - 12.4	18	0.4	1.3:1	UG-135/U		<a href="#">PEWIR1007</a>	\$2,268.15	\$2,177.42	\$2,086.70	\$1,995.97	93
WR-112	7.05 - 10	18	0.4	1.3:1	UG-138/U		<a href="#">PEWIR1006</a>	\$2,394.66	\$2,298.87	\$2,203.09	\$2,107.30	94

## WAVEGUIDE LOW NOISE AMPLIFIERS



RF Freq. (GHz.)	Gain (dB)	Gain Variation ± (dB)	NF (dB)	P1dB (dBm)	IP3 (dBm)	Waveguide Type	ECCN	Model No	1	2-4	5-9	10+	ROW
26.5 - 40	47	2.5	3.2	20	25	WR-28	EAR99	<a href="#">PE15A1076</a>	Call	Call	Call	Call	95
27 - 40	35	3	3	10	20		EAR99	<a href="#">PE15A1077</a>	Call	Call	Call	Call	96

## WAVEGUIDE MAGIC TEES



Waveguide Type	RF Frequency (GHz.)	Flange Type	IL (dB)	Min Isolation (dB)	ECCN	Model No	1	2-4	5-9	10+	ROW
WR-10	75 - 110	Round Cover UG-387/U-Mod	1	25	EAR99	<a href="#">PEWMT1000</a>	\$2,577.73	\$2,474.62	\$2,371.51	\$2,268.40	97
WR-12	60 - 90	Round Cover UG-387/U			EAR99	<a href="#">PEWMT1001</a>	\$2,604.23	\$2,500.06	\$2,395.89	\$2,291.72	98
WR-15	50 - 75	Round Cover UG-385/U			EAR99	<a href="#">PEWMT1002</a>	\$2,470.19	\$2,371.38	\$2,272.57	\$2,173.77	99
WR-19	40 - 60	Round Cover UG-383/U-Mod	0.8		EAR99	<a href="#">PEWMT1003</a>	\$2,227.89	\$2,138.77	\$2,049.66	\$1,960.54	1
WR-22	33 - 50	Round Cover UG-383/U	0.7		EAR99	<a href="#">PEWMT1004</a>	\$2,227.89	\$2,138.77	\$2,049.66	\$1,960.54	2
WR-28	26.5 - 40	Square Cover UG-599/U	0.5		EAR99	<a href="#">PEWMT1005</a>	\$2,122.20	\$2,037.31	\$1,952.42	\$1,867.54	3
WR-42	18 - 26.5	Square Cover UG-595/U		EAR99	<a href="#">PEWMT1006</a>	\$2,080.59	\$1,997.37	\$1,914.14	\$1,830.92	4	

## WAVEGUIDE ORTHOMODE TRANSDUCERS

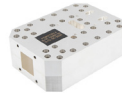

RF Freq. (GHz.)	H to A IL (dB)	V to A IL (dB)	H to V Isolation (dB)	H to A Cross Polarization (dB)	V to A Cross Polarization (dB)	Waveguide Type	ECCN	Model No	1	2-4	5-9	10+	ROW
8.2 - 12.4						WR-90	EAR99	<a href="#">PEWOT0014</a>	\$3,500.00	\$3,377.50	\$3,255.00	\$3,150.00	5
24 - 33	0.6		45	35	35	WR-34	EAR99	<a href="#">PEWOT0001</a>	\$4,875.00	\$4,704.38	\$4,533.75	\$4,387.50	6
26.5 - 40	0.5	0.5	40	35	35	WR-28	EAR99	<a href="#">PEWOT0007</a>	\$4,375.00	\$4,221.88	\$4,068.75	\$3,937.50	7
30 - 42				35	35		EAR99	<a href="#">PEWOT0003</a>	\$4,625.00	\$4,463.13	\$4,301.25	\$4,162.50	8
60 - 90	1.2	0.8		35	35	WR-12	EAR99	<a href="#">PEWOT0009</a>	\$4,400.00	\$4,246.00	\$4,092.00	\$3,960.00	9

## WAVEGUIDE PHASE SHIFTERS



WG Type	RF Freq. (GHz.)	Phase Range (GHz.)	Input Power (Watts)	IL (dB)	Length (in)	Flange Type	ECCN	Model No	1	2-4	5-9	10+	ROW
WR-10	75 - 110	0 - 180°	0.6	1	3	Round Cover UG-387/U-Mod	EAR99	<a href="#">PE-W10PS1001</a>	\$2,091.09	\$2,007.45	\$1,923.80	\$1,840.16	10
WR-12	60 - 90	0 - 180°	0.7	1	3	Round Cover UG-387/U	EAR99	<a href="#">PE-W12PS1001</a>	\$2,172.64	\$2,085.73	\$1,998.83	\$1,911.92	11
WR-15	50 - 75	0 - 180°	0.8	1	3	Round Cover UG-385/U	EAR99	<a href="#">PE-W15PS1001</a>	\$2,172.64	\$2,085.73	\$1,998.83	\$1,911.92	12
WR-19	40 - 60	0 - 180°	1	1	3	Round Cover UG-383/U-Mod	EAR99	<a href="#">PE-W19PS1001</a>	\$2,091.09	\$2,007.45	\$1,923.80	\$1,840.16	13
WR-22	33 - 50	0 - 180°	1	1	4	Round Cover UG-383/U	EAR99	<a href="#">PE-W22PS1001</a>	\$2,172.64	\$2,085.73	\$1,998.83	\$1,911.92	14
WR-28	26.5 - 40	0 - 180°	1		4	Square Cover UG-599/U	EAR99	<a href="#">PE-W28PS1002</a>	\$2,699.00	\$2,591.04	\$2,483.08	\$2,375.12	15
WR-42	18 - 26.5	0 - 180°	1.5	1	4	Square Cover UG-595/U	EAR99	<a href="#">PE-W42PS1001</a>	\$2,172.64	\$2,085.73	\$1,998.83	\$1,911.92	16



Technical Support  
+1 (949) 261-1920



Same-Day Shipping,  
Even Custom Cable Assemblies

## WAVEGUIDE PIN DIODE SWITCHES



WG Type	Switch Type	RF Freq. (GHz.)	IL (dB)	Min Isolation (dB)	Max Switching (in)	Flange Type	ECCN	Model No	1	2-4	5-9	10+	ROW
WR-10	SPST/ Reflective	75 - 110	5.5	20	300	Round Cover UG-387/U	EAR99	<a href="#">PE71S9003</a>	\$8,336.00	\$8,002.56	\$7,669.12	\$7,335.68	17
	SPDT/ Reflective		7	20	300	Round Cover UG-387/U	EAR99	<a href="#">PE71S9004</a>	\$9,899.00	\$9,503.04	\$9,107.08	\$8,711.12	18
WR-12	SPST/ Reflective	60 - 90	4.5	20	300	Round Cover UG-387/U	EAR99	<a href="#">PE71S9001</a>	\$7,640.99	\$7,335.35	\$7,029.71	\$6,724.07	19
	SPDT/ Reflective		6	20	300	Round Cover UG-387/U	EAR99	<a href="#">PE71S9002</a>	\$9,031.02	\$8,669.78	\$8,308.54	\$7,947.30	20

## PIN DIODE SWITCHES, see page 295

## WAVEGUIDE POLARIZERS



Band	RF Freq. (GHz.)	Typ Bandwidth (GHz)	Typ IL (dB)	Typ Axial Ratio (dB)	Length (in)	Flange Type	ECCN	Model No	1	2-4	5-9	10+	ROW
Ku	14 - 16	±1	0.5	1.1	3	Square Cover-UG-419/U-Mod	EAR99	<a href="#">PEWPL0000</a>	\$4,000.00	\$3,860.00	\$3,720.00	\$3,600.00	21
K	20 - 22			1.1	2	Square Cover-UG-595/U-Mod	EAR99	<a href="#">PEWPL0001</a>	Call	Call	Call	Call	22
	21 - 23			1.1	2	Square Cover-UG-595/U-Mod	EAR99	<a href="#">PEWPL0002</a>	Call	Call	Call	Call	23
	23 - 25			1.1	2	Square Cover-UG-595/U-Mod	EAR99	<a href="#">PEWPL0003</a>	Call	Call	Call	Call	24
				1.1	2	Square Cover-UG-595/U	EAR99	<a href="#">PEWPL0004</a>	Call	Call	Call	Call	25
Ka	26 - 33	±3.5	0.3	1.1	2	Square Cover-UG-599/U-Mod	EAR99	<a href="#">PEWPL0005</a>	\$4,000.00	\$3,860.00	\$3,720.00	\$3,600.00	26
	32 - 38	±2.6		1.1	2	Square Cover-UG-599/U-Mod	EAR99	<a href="#">PEWPL0007</a>	Call	Call	Call	Call	28
V	58 - 63	±2.5	0.5	1.1	1	Round Cover-UG-385/U-Mod	EAR99	<a href="#">PEWPL0008</a>	\$4,000.00	\$3,860.00	\$3,720.00	\$3,600.00	29
E	71 - 83	±6		1.1	1	Round Cover-UG-387/U-Mod	EAR99	<a href="#">PEWPL0009</a>	Call	Call	Call	Call	30
	71 - 86	±0		1.1	1	Round Cover-UG-387/U-Mod	EAR99	<a href="#">PEWPL0010</a>	Call	Call	Call	Call	31
W	92 - 96	±2	0.7	1.1	1	Round Cover-UG-387/U-Mod	EAR99	<a href="#">PEWPL0011</a>	Call	Call	Call	Call	32

## WAVEGUIDE POWER AMPLIFIERS



Waveguide Type	RF Frequency (GHz.)	Min Gain (dB)	Psat (dBm)	Flange Type	ECCN	Model No	1	2-4	5-9	10+	ROW
WR-12	70.5 - 76.5	25	20	Round Cover UG-387/U	EAR99	<a href="#">PE15A4023</a>	\$10,766.99	\$10,336.31	\$9,905.63	\$9,474.95	33
	80.5 - 86.5	20	19	Round Cover UG-387/U	EAR99	<a href="#">PE15A4024</a>	\$11,201.50	\$10,753.44	\$10,305.38	\$9,857.32	34

# WAVEGUIDE SECTIONS



WG Type	RF Freq. (GHz.)	IL (dB)	Max VSWR	Length (in)	Flange Type	ECCN	Model No	1 Pc. Price	See Web for Volume Pricing	ROW
WR-5	140 - 220			1			EAR99 <a href="#">PEW05S000-1</a>	\$569.00		35
				3			EAR99 <a href="#">PEW05S000-3</a>	\$529.00		36
				6			EAR99 <a href="#">PEW05S000-6</a>	\$679.00		37
				9			EAR99 <a href="#">PEW05S000-9</a>	\$779.00		38
WR-6	110 - 170			12	Round Cover UG-387/U-Mod		EAR99 <a href="#">PEW05S000-12</a>	\$899.00		39
				1			EAR99 <a href="#">PEW06S000-1</a>	\$459.00		40
				3			EAR99 <a href="#">PEW06S000-3</a>	\$499.00		41
				6			EAR99 <a href="#">PEW06S000-6</a>	\$649.00		42
WR-8	90 - 140			9			EAR99 <a href="#">PEW06S000-9</a>	\$749.00		43
				12			EAR99 <a href="#">PEW06S000-12</a>	\$869.00		44
				1			EAR99 <a href="#">PEW08S000-1</a>	\$399.00		45
				3			EAR99 <a href="#">PEW08S000-3</a>	\$439.00		46
WR-10	75 - 110			6			EAR99 <a href="#">PEW08S000-6</a>	\$599.00		47
				9			EAR99 <a href="#">PEW08S000-9</a>	\$749.00		48
				12			EAR99 <a href="#">PEW08S000-12</a>	\$869.00		49
				3			EAR99 <a href="#">PEW10S010-3</a>	\$468.28		50
WR-12	60 - 90	0.25	1.06:1	3	Round Cover UG-387/U		EAR99 <a href="#">PE-W12S001-3</a>	\$359.02		51
		0.64		9			EAR99 <a href="#">PE-W12S001-9</a>	\$470.38		52
		0.82		12			EAR99 <a href="#">PE-W12S001-12</a>	\$488.44		53
				3			EAR99 <a href="#">PEW12S010-3</a>	\$359.02		54
WR-15	50 - 75		1.15:1	6			EAR99 <a href="#">PEW12S010-6</a>	\$406.38		55
				9			EAR99 <a href="#">PEW12S010-9</a>	\$470.38		56
				12			EAR99 <a href="#">PE-W15S001-12</a>	\$383.74		57
				3			EAR99 <a href="#">PE-W15S001-3</a>	\$419.94		58
WR-19	40 - 60	0.2	1.06:1	6	Round Cover UG-385/U		EAR99 <a href="#">PE-W15S001-6</a>	\$419.94		59
		0.34		9			EAR99 <a href="#">PE-W15S001-9</a>	\$459.92		60
		0.49		12			EAR99 <a href="#">PE-W15S001-12</a>	\$640.93		61
		0.64		3			EAR99 <a href="#">PEW15S010-3</a>	\$640.93		62
WR-22	33 - 50			3	Round Cover UG-383/U-Mod		EAR99 <a href="#">PE-W19S001-3</a>	\$356.31		63
				6			EAR99 <a href="#">PE-W19S001-6</a>	\$404.18		64
				9			EAR99 <a href="#">PE-W19S001-9</a>	\$459.92		65
				12			EAR99 <a href="#">PE-W19S001-12</a>	\$522.64		66
WR-28	26.5 - 40	0.15	1.06:1	3			EAR99 <a href="#">PEW19S010-3</a>	\$356.31		67
		0.25		6			EAR99 <a href="#">PEW19S010-6</a>	\$522.64		68
		0.34		9			EAR99 <a href="#">PE-W22S001-9</a>	\$371.22		69
		0.44		12			EAR99 <a href="#">PE-W22S001-12</a>	\$420.07		70
WR-34	20 - 33			3	Round Cover UG-383/U		EAR99 <a href="#">PE-W22S001-3</a>	\$352.94		71
				6			EAR99 <a href="#">PE-W22S001-6</a>	\$371.22		72
				9			EAR99 <a href="#">PE-W22S001-9</a>	\$420.07		73
				12			EAR99 <a href="#">PE-W22S001-12</a>	\$505.22		74
WR-42	18 - 26.5			3	Square Cover UG-599/U		EAR99 <a href="#">PEW22S010-3</a>	\$399.00		75
				6			EAR99 <a href="#">PEW22S010-6</a>	\$590.48		76
				9			EAR99 <a href="#">PEW28S001-9</a>	\$435.54		77
				12			EAR99 <a href="#">PE-W28S001-12</a>	\$524.92		78
WR-51	15 - 22	0.11	1.06:1	3			EAR99 <a href="#">PEW28S010-3</a>	\$363.00		79
		0.22		6			EAR99 <a href="#">PEW28S010-6</a>	\$521.00		80
		0.28		9			EAR99 <a href="#">PEWSP1001</a>	\$521.00		81
				12			EAR99 <a href="#">PEW28S010-12</a>	\$405.00		82
WR-55	12.4 - 18			4	Square Cover UG-1530/U		EAR99 <a href="#">PEWSP1002</a>	\$538.38		83
				6			EAR99 <a href="#">PE-W42S002-6</a>	\$399.00		84
				9			EAR99 <a href="#">PE-W42S001A-9</a>	\$365.40		85
				12			EAR99 <a href="#">PE-W42S001A-12</a>	\$431.04		86
WR-62	10 - 15			4	Square Cover UG-595/U		EAR99 <a href="#">PEWSP1003</a>	\$521.00		87
				6			EAR99 <a href="#">PE-W42S001-12</a>	\$524.92		88
				9			EAR99 <a href="#">PE-W51S001-9</a>	\$394.02		89
				12			EAR99 <a href="#">PE-W51S001-12</a>	\$495.97		90
WR-75	8.2 - 12.4	0.1	1.03:1	4	Square Cover		EAR99 <a href="#">PEWSP1004</a>	\$555.75		91
				6			EAR99 <a href="#">PE-W62S002-6</a>	\$450.15		92
				9			EAR99 <a href="#">PE-W62S002-9</a>	\$504.33		93
				12			EAR99 <a href="#">PE-W62S002-12</a>	\$571.02		94
WR-90				3	Square Cover UG-419/U		EAR99 <a href="#">PE-W62S002-3</a>	\$312.60		95
				4			EAR99 <a href="#">PEWSP1005</a>	\$527.96		96
				6			EAR99 <a href="#">PE-W62S001-6</a>	\$319.34		97
				9			EAR99 <a href="#">PE-W62S001-9</a>	\$326.06		98
WR-99				12	Square Cover UG-39/U		EAR99 <a href="#">PE-W62S001-12</a>	\$332.78		99
				6			EAR99 <a href="#">PE-W75S001A-6</a>	\$312.60		1
				9			EAR99 <a href="#">PE-W75S001-9</a>	\$321.43		2
				12			EAR99 <a href="#">PEWSP1006</a>	\$538.38		3
WR-99				6	Square Cover		EAR99 <a href="#">PE-W75S001-6</a>	\$312.60		4
				9			EAR99 <a href="#">PE-W75S001-9</a>	\$319.34		5
				12			EAR99 <a href="#">PE-W75S001-12</a>	\$294.75		
				9			EAR99 <a href="#">PE-W90S001A-9</a>	\$238.66		

See Our Website For Current Pricing & Real-Time Stock Availability!

See Web for Volume Pricing

Waveguides



Technical Support  
+1 (949) 261-1920



Same-Day Shipping,  
Even Custom Cable Assemblies

## WAVEGUIDE SECTIONS

WG Type	RF Freq. (GHz.)	IL (dB)	Max VSWR	Length (in)	Flange Type	ECCN	Model No	1 Pc. Price	See Web for Volume Pricing	ROW					
WR-90	8.2 - 12.4			3	Square Cover UG-39/U	EAR99	<a href="#">PE-W90S001-3</a>	\$205.05	See Web for Volume Pricing	6					
					CPR-90G	EAR99	<a href="#">PE-W90S002-3</a>	\$276.87		7					
				4	Square Cover UG-39/U	EAR99	<a href="#">PEWSP1007</a>	\$555.75		8					
					CPR-90G	EAR99	<a href="#">PEWSP1008</a>	\$562.68		9					
				6	Square Cover UG-39/U	EAR99	<a href="#">PE-W90S001-6</a>	\$208.40		10					
					CPR-90G	EAR99	<a href="#">PE-W90S002-6</a>	\$303.14		11					
				9	Square Cover UG-39/U	EAR99	<a href="#">PE-W90S001-9</a>	\$238.66		12					
					CPR-90G	EAR99	<a href="#">PE-W90S002-9</a>	\$297.71		13					
				12	Square Cover UG-39/U	EAR99	<a href="#">PE-W90S001-12</a>	\$249.52		14					
					CPR-90G	EAR99	<a href="#">PE-W90S002-12</a>	\$309.62		15					
				WR-112	7.05 - 10			3		Square Cover UG-51/U	EAR99	<a href="#">PE-W112S001-3</a>	\$315.97	See Web for Volume Pricing	16
										CPR-112G	EAR99	<a href="#">PEWSP1009</a>	\$573.10		17
4	Square Cover UG-51/U	EAR99	<a href="#">PE-W112S001-4</a>					\$303.68	18						
	CPR-112G	EAR99	<a href="#">PEWSP1010</a>					\$576.59	19						
6	Square Cover UG-51/U	EAR99	<a href="#">PE-W112S001-6</a>					\$352.94	20						
	CPR-112G	EAR99	<a href="#">PE-W112S001-12</a>					\$321.53	21						
WR-137	5.85 - 8.2			3	Round Cover UG-344/U	EAR99	<a href="#">PE-W137S001-3</a>	\$337.18	See Web for Volume Pricing	22					
					CPR-137G	EAR99	<a href="#">PE-W137S002-3</a>	\$336.14		23					
				4	Round Cover UG-344/U	EAR99	<a href="#">PEWSP1011</a>	\$597.43		24					
					CPR-137G	EAR99	<a href="#">PEWSP1012</a>	\$583.52		25					
				6	Round Cover UG-344/U	EAR99	<a href="#">PE-W137S001-6</a>	\$339.39		26					
					CPR-137G	EAR99	<a href="#">PE-W137S002-6</a>	Call		27					
				9	Round Cover UG-344/U	EAR99	<a href="#">PE-W137S001-9</a>	\$371.21		28					
					CPR-137G	EAR99	<a href="#">PE-W137S002-9</a>	\$349.55		29					
				12	Round Cover UG-344/U	EAR99	<a href="#">PE-W137S001-12</a>	\$383.58		30					
					CPR-137G	EAR99	<a href="#">PE-W137S002-12</a>	\$400.01		31					

## WAVEGUIDE TERMINATIONS

Waveguide Type	RF Frequency (GHz.)	Input Power (Watts)	Max VSWR	Length (in)	Flange Type	ECCN	Model No	1 Pc. Price	See Web for Volume Pricing	ROW
WR-10	75 - 110	0.4	1.06:1		Round Cover UG-387/U	EAR99	<a href="#">PEW10TR0001</a>	\$519.00	See Web for Volume Pricing	32
			1.25:1		Round Cover UG-387/U-Mod	EAR99	<a href="#">PE-W10TR1001</a>	\$539.24		33
WR-12	60 - 90	0.6	1.2:1	2	Round Cover UG-387/U	EAR99	<a href="#">PE-W12TR1001</a>	\$520.11	See Web for Volume Pricing	34
WR-15	50 - 75	1	1.2:1		Round Cover UG-385/U	EAR99	<a href="#">PEW15TR0001</a>	\$549.00		35
					Round Cover UG-383/U	EAR99	<a href="#">PEW19TR0001</a>	\$467.84		36
WR-19	40 - 60	2	1.09:1		Round Cover UG-383/U-Mod	EAR99	<a href="#">PE-W19TR1001</a>	\$486.09		37
					Round Cover UG-383/U	EAR99	<a href="#">PE-W22TR1002</a>	\$475.00		38
WR-28	26.5 - 40		0.5		1.3:1	Square Cover UG-599/U	EAR99	<a href="#">PE6800</a>		\$442.65
			0.5	1.05:1	Square Cover	EAR99	<a href="#">PE6809</a>	\$847.84	40	
			0.5	1.02:1	Square Cover UG-599/U	EAR99	<a href="#">PEWTR1000</a>	\$656.81	41	
			5	1.07:1	Square Cover UG-599/U	EAR99	<a href="#">PE-W28TR1001</a>	\$520.11	42	
			40	1.07:1	Square Cover	EAR99	<a href="#">PE6818</a>	\$922.54	43	
WR-34	22 - 33		0.5	1.25:1	Square Cover	EAR99	<a href="#">PE6200</a>	\$881.27	See Web for Volume Pricing	44
			0.5	1.05:1	Square Cover	EAR99	<a href="#">PE6801</a>	\$352.22		45
			1	1.25:1	Square Cover	EAR99	<a href="#">PE6810</a>	\$815.22		46
			1	1.25:1	Square Cover UG-1530/U	EAR99	<a href="#">PEWTR1001</a>	\$583.52		47
			45	1.1:1	Square Cover	EAR99	<a href="#">PE6819</a>	\$1,322.79		48
WR-42	18 - 26.5		0.5	1.25:1	Square Cover	EAR99	<a href="#">PE6828</a>	\$1,209.77	See Web for Volume Pricing	49
			0.5	1.05:1	Square Cover UG-597/U	EAR99	<a href="#">PE6802</a>	\$432.24		50
			0.5	1.05:1	Square Cover	EAR99	<a href="#">PE6811</a>	\$960.30		51
			1	1.02:1	Square Cover UG-595/U	EAR99	<a href="#">PEWTR1002</a>	\$570.20		52
			6	1.08:1	Square Cover UG-595/U	EAR99	<a href="#">PE-W42TR1001</a>	\$520.11		53
			50	1.07:1	Square Cover	EAR99	<a href="#">PE6820</a>	\$925.08		54
100	1.1:1	Square Cover	EAR99	<a href="#">PE6829</a>	\$913.94	55				



## WAVEGUIDE TERMINATIONS

Waveguide Type	RF Frequency (GHz.)	Input Power (Watts)	Max VSWR	Length (in)	Flange Type	ECCN	Model No	1 Pc. Price	See Web for Volume Pricing	ROW
WR-51	15 - 18	1	1.2:1	1	Square Cover	EAR99	<a href="#">PE6803</a>	\$396.54	See Web for Volume Pricing	56
	15 - 22	1	1.05:1	3	Square Cover	EAR99	<a href="#">PE6812</a>	\$992.32		57
		1	1.02:1		Square Cover	EAR99	<a href="#">PEWTR1003</a>	\$591.86		58
	15 - 18	55	1.07:1	4	Square Cover	EAR99	<a href="#">PE6821</a>	\$856.11		59
15 - 22	100	1.1:1	Square Cover		EAR99	<a href="#">PE6830</a>	\$1,233.48	60		
11.9 - 18	2	1.03:1	Square Cover		EAR99	<a href="#">PE6201A</a>	Call	61		
WR-62	12.4 - 18	1.5	1.02:1		Square Cover UG-419/U	EAR99	<a href="#">PEWTR1004</a>	\$555.75		62
		2	1.2:1	1	Square Cover	EAR99	<a href="#">PE6804</a>	\$445.73		63
		60	1.07:1	4	Square Cover	EAR99	<a href="#">PE6836</a>	\$867.76		64
		175	1.1:1		Square Cover	EAR99	<a href="#">PE6831</a>	\$1,233.49		65
WR-75	10 - 15	2	1.2:1	1	Square Cover	EAR99	<a href="#">PE6805</a>	\$663.98		66
		2	1.05:1	4	Square Cover	EAR99	<a href="#">PE6814</a>	\$801.74		67
		2.5	1.02:1		Square Cover	EAR99	<a href="#">PEWTR1005</a>	\$598.53		68
		75	1.07:1	5	Square Cover	EAR99	<a href="#">PE6823</a>	\$802.58	69	
		175	1.1:1	6	Square Cover	EAR99	<a href="#">PE6832</a>	\$1,349.66	70	
WR-90	8.2 - 12.4	2	1.2:1	1	Square Cover UG-135/U	EAR99	<a href="#">PE6806</a>	\$481.10	71	
		2	1.05:1	4	Square Cover	EAR99	<a href="#">PE6815</a>	\$770.91	72	
		4	1.02:1		Square Cover UG-39/U	EAR99	<a href="#">PEWTR1006</a>	\$548.55	73	
		4	1.02:1	6	CPR-90G	EAR99	<a href="#">PEWTR1007</a>	\$559.38	74	
		90	1.07:1		Square Cover	EAR99	<a href="#">PE6824</a>	\$1,141.86	75	
		200	1.1:1		Square Cover	EAR99	<a href="#">PE6833</a>	\$1,502.44	76	
WR-102	7 - 11	2	1.2:1		1	Square Cover	EAR99	<a href="#">PE6807</a>	\$408.11	77
		2	1.05:1	4	Square Cover	EAR99	<a href="#">PE6816</a>	\$713.43	78	
		300	1.1:1	7	Square Cover	EAR99	<a href="#">PE6834</a>	\$1,537.02	79	
WR-112	7.05 - 10	2	1.2:1	1	Square Cover	EAR99	<a href="#">PE6808</a>	\$444.80	80	
WR-112	7.05 - 10	5	1.02:1	7	Square Cover UG-51/U	EAR99	<a href="#">PEWTR1008</a>	\$584.62	81	
		5	1.02:1		CPR-112G	EAR99	<a href="#">PEWTR1009</a>	\$633.28	82	
		100	1.1:1		Square Cover	EAR99	<a href="#">PE6826</a>	\$1,037.85	83	
		300	1.1:1		Square Cover	EAR99	<a href="#">PE6835</a>	\$2,076.96	84	
WR-137	5.85 - 8.2	6	1.02:1		Round Cover UG-344/U	EAR99	<a href="#">PEWTR1010</a>	\$617.10	85	

## WAVEGUIDE TRANSITIONS

WG 1 Type	Flange 1 Type	WG 2 Type	Flange 2 Type	VSWR	ECCN	Model No	1 Pc. Price	See Web for Volume Pricing	ROW
WR-10	Round Cover UG-387/U-Mod	WR-12	Round Cover UG-387/U	1.6:1	EAR99	<a href="#">PE-W10TS12001A</a>	\$1,252.04	See Web for Volume Pricing	86
		WR-15	Round Cover UG-385/U	1.45:1	EAR99	<a href="#">PE-W10TS15001</a>	\$1,252.04		87
		WR-19	Round Cover UG-383/U-Mod	1.4:1	EAR99	<a href="#">PE-W10TS19001</a>	\$1,311.36		88
WR-12	Round Cover UG-387/U	WR-15	Round Cover UG-385/U	1.2:1	EAR99	<a href="#">PE-W12TS15001</a>	\$1,302.12		89
WR-15	Round Cover UG-385/U	WR-19	Round Cover UG-383/U-Mod	1.1:1	EAR99	<a href="#">PE-W15TS19001</a>	\$1,302.12		90
WR-19	Round Cover UG-383/U-Mod	WR-22	Round Cover UG-383/U	1.15:1	EAR99	<a href="#">PE-W15TS22001</a>	\$1,311.36		91
		WR-22	Round Cover UG-383/U	1.5:1	EAR99	<a href="#">PE-W19TS22001</a>	\$1,252.04		92
WR-22	Round Cover UG-383/U	WR-28	Square Cover UG-599/U	1.35:1	EAR99	<a href="#">PE-W19TS28001</a>	\$1,302.12		93
		WR-28	Square Cover UG-599/U	1.35:1	EAR99	<a href="#">PE-W22TS28001</a>	\$1,302.12		94
WR-28	Square Cover UG-599/U	WR-42	Square Cover UG-595/U	1.35:1	EAR99	<a href="#">PE-W22TS42001</a>	\$1,205.04		95
		WR-42	Square Cover UG-595/U	1.2:1	EAR99	<a href="#">PE-W28TS42001</a>	\$1,205.04		96
		WR-51	UBR-180/U-Mod	1.38:1	EAR99	<a href="#">PE-W28TS51001</a>	\$1,362.50		97
WR-34	Square Cover UG-1530/U	WR-28	Square Cover UG-599/U	1.08:1	EAR99	<a href="#">PEWTS1010</a>	\$797.47		98
WR-42	Square Cover UG-595/U	WR-34	Square Cover UG-1530/U	1.08:1	EAR99	<a href="#">PEWTS1009</a>	\$773.33	99	
WR-62	Square Cover UG-1665/U	WR-51	Square Cover	1.08:1	EAR99	<a href="#">PEWTS1007A</a>	\$805.03	1	
WR-75	Square Cover	WR-62	Square Cover UG-1665/U	1.08:1	EAR99	<a href="#">PEWTS1006</a>	\$836.43	2	
WR-90	Square Cover UG-39/U	WR-75	Square Cover	1.08:1	EAR99	<a href="#">PEWTS1004</a>	\$847.56	3	
WR-112	Square Cover UG-51/U	WR-90	Square Cover UG-39/U	1.08:1	EAR99	<a href="#">PEWTS1002</a>	\$897.04	4	
	CPR-112G	WR-90	CPR-90G	1.08:1	EAR99	<a href="#">PEWTS1003</a>	\$851.46	5	
WR-137	Round Cover UG-344/U	WR-112	Square Cover UG-51/U	1.08:1	EAR99	<a href="#">PEWTS1000</a>	\$958.90	6	
	CPR-137G	WR-112	CPR-112G	1.08:1	EAR99	<a href="#">PEWTS1001</a>	\$965.11	7	

## WAVEGUIDE TWISTS



WG Type	RF Freq. (GHz.)	Max VSWR	WG Offset Angle (Deg)	Length (in)	Flange Type	ECCN	Model No	1-9	10-24	25-49	50+	ROW
WR-10	75 - 110	1.1:1	45 Left-hand	1	Round Cover UG-387/U-Mod	EAR99	<a href="#">PE-W10TW1002</a>	\$418.22	\$397.31	\$376.40	\$359.67	8
			45 Right-hand				<a href="#">PE-W10TW1003</a>	\$418.22	\$397.31	\$376.40	\$359.67	9
		1.43:1	90				<a href="#">PE-W10TW1001</a>	\$394.41	\$374.69	\$354.97	\$339.19	10
WR-12	60 - 90	1.16:1	45 Left-hand	1	Round Cover UG-387/U	EAR99	<a href="#">PE-W12TW1002</a>	\$418.22	\$397.31	\$376.40	\$359.67	11
			45 Right-hand				<a href="#">PE-W12TW1003</a>	\$418.22	\$397.31	\$376.40	\$359.67	12
		1.12:1	90				<a href="#">PE-W12TW001</a>	\$467.86	\$444.47	\$421.07	\$402.36	13
			90				<a href="#">PE-W12TW1001</a>	\$467.86	\$444.47	\$421.07	\$402.36	14
WR-15	50 - 75	1.11:1	45 Left-hand	1	Round Cover UG-385/U	EAR99	<a href="#">PE-W15TW1002</a>	\$418.22	\$397.31	\$376.40	\$359.67	15
			45 Right-hand				<a href="#">PE-W15TW1003</a>	\$418.22	\$397.31	\$376.40	\$359.67	16
			90				<a href="#">PE-W15TW1001</a>	\$394.41	\$374.69	\$354.97	\$339.19	17
WR-19	40 - 60	1.25:1	45 Left-hand	1	Round Cover UG-383/U-Mod	EAR99	<a href="#">PE-W19TW1002</a>	\$418.22	\$397.31	\$376.40	\$359.67	18
			45 Right-hand				<a href="#">PE-W19TW1003</a>	\$418.22	\$397.31	\$376.40	\$359.67	19
WR-22	33 - 50	1.02:1	45 Left-hand	2	Round Cover UG-383/U-Mod	EAR99	<a href="#">PE-W19TW1001</a>	\$368.60	\$350.17	\$331.74	\$317.00	20
			45 Right-hand				<a href="#">PE-W22TW1002</a>	\$418.22	\$397.31	\$376.40	\$359.67	21
		1.15:1	90				<a href="#">PE-W22TW1003</a>	\$418.22	\$397.31	\$376.40	\$359.67	22
			90				<a href="#">PEW22TW001</a>	\$368.60	\$350.17	\$331.74	\$317.00	23
			90				<a href="#">PEW22TW001</a>	\$368.60	\$350.17	\$331.74	\$317.00	24
WR-28	26.5 - 40	1.1:1	45 Right-hand	1	Square Cover UG-595/U	EAR99	<a href="#">PEW28TW001</a>	\$447.50	\$425.13	\$402.75	\$384.85	25
			45 Left-hand				<a href="#">PEW28TW1002</a>	\$447.50	\$425.13	\$402.75	\$384.85	26
		1.09:1	45 Right-hand				<a href="#">PE-W28TW1003</a>	\$447.50	\$425.13	\$402.75	\$384.85	27
			90				<a href="#">PEW28TW1001</a>	\$368.60	\$350.17	\$331.74	\$317.00	28
WR-42	18 - 26.5	1.25:1	45 Left-hand	3	Square Cover UG-595/U	EAR99	<a href="#">PE-W42TW1002</a>	\$435.95	\$414.15	\$392.36	\$374.92	29
			45 Right-hand				<a href="#">PE-W42TW1003</a>	\$435.95	\$414.15	\$392.36	\$374.92	30
		1.07:1	90				<a href="#">PE-W42TW1001</a>	\$413.38	\$392.71	\$372.04	\$355.51	31
WR-8	90 - 140		45 Left-hand	1	Square Cover UG-387/U-Mod	EAR99	<a href="#">PEW8TW0001</a>	\$499.00	\$474.05	\$449.10	\$429.14	32
			90 Right-hand				<a href="#">PEW8TW0002</a>	\$499.00	\$474.05	\$449.10	\$429.14	33
WR-6	110 - 170		45 Right-hand	1	Square Cover UG-387/U-Mod	EAR99	<a href="#">PEW6TW0000</a>	\$499.00	\$474.05	\$449.10	\$429.14	34
			45 Left-hand				<a href="#">PEW6TW0001</a>	\$499.00	\$474.05	\$449.10	\$429.14	35
			90 Right-hand				<a href="#">PEW6TW0002</a>	\$499.00	\$474.05	\$449.10	\$429.14	36
WR-5	140 - 220		45 Right-hand	1	Square Cover UG-387/U-Mod	EAR99	<a href="#">PEW5TW0000</a>	\$529.00	\$502.55	\$476.10	\$454.94	37
			45 Left-hand				<a href="#">PEW5TW0001</a>	\$529.00	\$502.55	\$476.10	\$454.94	38
			90 Right-hand				<a href="#">PEW5TW0002</a>	\$529.00	\$502.55	\$476.10	\$454.94	39

## WAVEGUIDE VARIABLE ATTENUATORS



Waveguide Type	RF Frequency (GHz.)	Flange Type	IL (dB)	Max Atten. (dB)	ECCN	Model No	1	2-4	5-9	10+	ROW
WR-10	75 - 110	Round Cover UG-387/U-Mod	1	30	EAR99	<a href="#">PE-W10AT002-30</a>	\$1,859.97	\$1,785.57	\$1,711.17	\$1,636.77	40
WR-15	50 - 75	Round Cover UG-385/U	0.8		EAR99	<a href="#">PE-W15AT001-30</a>	\$1,923.04	\$1,846.12	\$1,769.20	\$1,692.28	41
WR-19	40 - 60	Round Cover UG-383/U-Mod	0.6		EAR99	<a href="#">PE-W19AT001-30</a>	\$1,877.30	\$1,802.21	\$1,727.12	\$1,652.02	42
WR-22	33 - 50	Round Cover UG-383/U	0.5		EAR99	<a href="#">PE-W22AT001-30</a>	\$1,840.48	\$1,776.06	\$1,711.65	\$1,656.43	43

## WAVEGUIDE ACCESSORIES



Waveguide Type	Description	Model No	1-9	10-24	25-49	50+	ROW
WR-10	WR-10 Waveguide Shim, UG-Cover Round flange, 2mm Brass	<a href="#">PEW10FS2</a>	\$95.00	\$90.25	\$85.50	\$81.70	44
	WR-10 Waveguide Short Plate, UG-Cover Round Flange, 4mm Copper	<a href="#">PEW10SP4</a>	\$95.00	\$90.25	\$85.50	\$81.70	45
WR-12	WR-12 Waveguide Shim, UG-Cover Round flange, 2mm Brass	<a href="#">PEW12FS2</a>	\$95.00	\$90.25	\$85.50	\$81.70	46
	WR-12 Waveguide Short Plate, UG-Cover Round Flange, 4mm Copper	<a href="#">PEW12SP4</a>	\$95.00	\$90.25	\$85.50	\$81.70	47
WR-15	WR-15 Waveguide Shim, UG-Cover Round flange, 2mm Brass	<a href="#">PEW15FS2</a>	\$95.00	\$90.25	\$85.50	\$81.70	48
	WR-15 Waveguide Short Plate, UG-Cover Round Flange, 4mm Copper	<a href="#">PEW15SP4</a>	\$95.00	\$90.25	\$85.50	\$81.70	49
WR-19	WR-19 Waveguide Shim, UG-Cover Round flange, 3mm Brass	<a href="#">PEW19FS3</a>	\$95.00	\$90.25	\$85.50	\$81.70	50

# WAVEGUIDE ACCESSORIES



Waveguide Type	Description	Model No	1 Pc. Price	See Web for Volume Pricing	ROW
WR-19	WR-19 Waveguide Short Plate, UG-Cover Round Flange, 4mm Copper	<a href="#">PEW19SP4</a>	\$95.00	See Web for Volume Pricing	51
WR-22	WR-22 Waveguide Shim, UG-Cover Round flange, 3mm Brass	<a href="#">PEW22FS3</a>	\$95.00		52
	WR-22 Waveguide Short Plate, UG-Cover Round Flange, 4mm Copper	<a href="#">PEW22SP4</a>	\$95.00		53
WR-28	WR-28 Waveguide Electrically Conductive Gasket kit Square Cover, Choke Flange	<a href="#">PEWGGK1014</a>	\$106.00		54
	WR-28 Waveguide Gasket kit Square Cover, Choke Flange, Non-Conductive	<a href="#">PEWGGK1000</a>	\$44.12		55
	WR-28 Waveguide Shim, UG-Cover Square flange, 3mm Brass	<a href="#">PEW28FS3</a>	\$126.67		56
WR-34	WR-28 Waveguide Short Plate, UG-Cover Square Flange, 5mm Copper	<a href="#">PEW28SP4</a>	\$126.67		57
	WR-34 Waveguide Shim, UG-Cover Square flange, 4mm Brass	<a href="#">PEW34FS4</a>	Call		58
WR-42	WR-34 Waveguide Short Plate, UG-Cover Square Flange, 4mm Copper	<a href="#">PEW34SP4</a>	\$126.67		59
	WR-42 Waveguide Shim, UG-Cover Square flange, 4mm Brass	<a href="#">PEW42FS4</a>	\$126.67		60
WR-51	WR-42 Waveguide Short Plate, UG-Cover Square Flange, 4mm Copper	<a href="#">PEW42SP4</a>	\$126.67		61
	WR-42, WR-34 Waveguide Electrically Conductive Gasket kit Square Cover, Choke Flange	<a href="#">PEWGGK1015</a>	\$122.17		62
	WR-42, WR-34 Waveguide Gasket kit Square Cover, Choke Flange, Non-Conductive	<a href="#">PEWGGK1001</a>	\$42.70		63
WR-62	WR-51 Waveguide Electrically Conductive Gasket kit Square Cover, Choke Flange	<a href="#">PEWGGK1016</a>	\$134.36		64
	WR-51 Waveguide Gasket kit Square Cover, Choke Flange, Non-Conductive	<a href="#">PEWGGK1002</a>	\$43.66		65
WR-75	WR-62 Waveguide Electrically Conductive Gasket kit Square Cover, Choke Flange	<a href="#">PEWGGK1017</a>	\$196.36		66
	WR-62 Waveguide Gasket kit Square Cover, Choke Flange, Non-Conductive	<a href="#">PEWGGK1003</a>	\$48.77		67
	WR-62 Waveguide Shim, UG-Cover Square flange, 5mm Brass	<a href="#">PEW62FS5</a>	\$63.33		68
WR-90	WR-62 Waveguide Short Plate, UG-Cover Square Flange, 5mm Copper	<a href="#">PEW62SP5</a>	\$79.17		69
	WR-75 Waveguide Electrically Conductive Gasket kit Square Cover, Choke Flange	<a href="#">PEWGGK1018</a>	\$121.91		70
	WR-75 Waveguide Gasket kit Square Cover, Choke Flange, Non-Conductive	<a href="#">PEWGGK1004</a>	\$48.77		71
WR-112	WR-75 Waveguide Shim, UG-Cover Square flange, 5mm Brass	<a href="#">PEW75FS5</a>	\$66.50		72
	WR-75 Waveguide Short Plate, UG-Cover Square Flange, 5mm Copper	<a href="#">PEW75SP5</a>	\$79.17		73
	WR-90 Waveguide Electrically Conductive Gasket kit Square Cover, Choke Flange	<a href="#">PEWGGK1019</a>	\$170.93		74
WR-137	WR-90 Waveguide Electrically Conductive Gasket kit, CPR Flat Flange	<a href="#">PEWGGK1021</a>	\$125.85		75
	WR-90 Waveguide Electrically Conductive Gasket kit, CPR Grooved Flange	<a href="#">PEWGGK1020</a>	\$145.30		76
	WR-90 Waveguide Gasket kit Square Cover, Choke Flange, Non-Conductive	<a href="#">PEWGGK1005</a>	\$52.45		77
	WR-90 Waveguide Gasket kit, CPR90 Flat Flange, Non-Conductive	<a href="#">PEWGGK1007</a>	\$59.12		78
	WR-90 Waveguide Gasket kit, CPR90 Grooved Flange, Non-Conductive	<a href="#">PEWGGK1006</a>	\$59.12		79
	WR-90 Waveguide Shim, UG-Cover Square flange, 5mm Brass	<a href="#">PEW90FS5</a>	\$66.50		80
	WR-90 Waveguide Short Plate, UG-Cover Square Flange, 5mm Brass	<a href="#">PEW90SP5</a>	\$79.17		81
WR-159	WR-112 Waveguide Electrically Conductive Gasket kit Square Cover, Choke Flange	<a href="#">PEWGGK1022</a>	\$148.43	82	
	WR-112 Waveguide Electrically Conductive Gasket kit, CPR Flat Flange	<a href="#">PEWGGK1024</a>	\$133.90	83	
	WR-112 Waveguide Electrically Conductive Gasket kit, CPR Grooved Flange	<a href="#">PEWGGK1023</a>	\$185.94	84	
	WR-112 Waveguide Gasket kit Square Cover, Choke Flange, Non-Conductive	<a href="#">PEWGGK1008</a>	\$52.45	85	
	WR-112 Waveguide Gasket kit, CPR112 Flat Flange, Non-Conductive	<a href="#">PEWGGK1010</a>	\$60.90	86	
	WR-112 Waveguide Gasket kit, CPR112 Grooved Flange, Non-Conductive	<a href="#">PEWGGK1009</a>	\$60.90	87	
	WR-112 Waveguide Shim, UG-Cover Square flange, 5mm Brass	<a href="#">PEW112FS5</a>	\$79.17	88	
WR-187	WR-112 Waveguide Short Plate, UG-Cover Square Flange, 5mm Copper	<a href="#">PEW112SP5</a>	\$79.17	89	
	WR-137 Waveguide Electrically Conductive Gasket kit, CPR Grooved Flange	<a href="#">PEWGGK1026</a>	\$174.57	90	
	WR-137 Waveguide Electrically Conductive Gasket kit, CPR Grooved Flange	<a href="#">PEWGGK1027</a>	\$148.43	91	
	WR-137 Waveguide Electrically Conductive Gasket kit, Round Cover, Choke Flange	<a href="#">PEWGGK1025</a>	\$294.09	92	
	WR-137 Waveguide Gasket kit Round Cover, Choke Flange, Non-Conductive	<a href="#">PEWGGK1011</a>	\$54.61	93	
	WR-137 Waveguide Gasket kit, CPR137 Flat Flange, Non-Conductive	<a href="#">PEWGGK1013</a>	\$62.80	94	
	WR-137 Waveguide Gasket kit, CPR137 Grooved Flange, Non-Conductive	<a href="#">PEWGGK1012</a>	\$62.80	95	
WR-284	WR-137 Waveguide Shim, CPR-137F flange, 7mm Brass	<a href="#">PEW137FS7</a>	\$101.33	96	
	WR-137 Waveguide Short Plate, CPR-137F Flange, 7mm Copper	<a href="#">PEW137SP7</a>	\$95.00	97	
WR-340	WR-159 Waveguide Shim, CPR-159F flange, 7mm Aluminum	<a href="#">PEW159FS7</a>	\$79.17	98	
	WR-159 Waveguide Short Plate, CPR-159F Flange, 7mm Aluminum	<a href="#">PEW159SP7</a>	\$79.17	99	
WR-430	WR-187 Waveguide Shim, CPR-187F flange, 7mm Aluminum	<a href="#">PEW187FS7</a>	\$79.17	1	
	WR-187 Waveguide Short Plate, CPR-187F Flange, 7mm Aluminum	<a href="#">PEW187SP7</a>	\$79.17	2	
WR-430	WR-284 Waveguide Shim, CPR-284F flange, 8mm Aluminum	<a href="#">PEW284FS8</a>	\$95.00	3	
	WR-284 Waveguide Short Plate, CPR-284F Flange, 8mm Aluminum	<a href="#">PEW284SP8</a>	\$95.00	4	
WR-430	WR-340 Waveguide Shim, CPR-340F flange, 10mm Aluminum	<a href="#">PEW340FS10</a>	\$114.00	5	
	WR-340 Waveguide Short Plate, CPR-340F Flange, 10mm Aluminum	<a href="#">PEW340SP10</a>	\$142.50	6	
WR-430	WR-430 Waveguide Shim, CPR-430F flange, 10mm Aluminum	<a href="#">PEW430FS10</a>	\$114.00	7	
	WR-430 Waveguide Short Plate, CPR-430F Flange, 10mm Aluminum	<a href="#">PEW430SP10</a>	\$140.00	8	
WR-430	4-40 with 3/32 inch Hex, Stainless Steel Waveguide Flange Screw	<a href="#">PEWGHW9000</a>	\$4.46	9	
	Waveguide Table Jack, Large	<a href="#">PEWGHW1001</a>	\$342.85	10	
	Waveguide Table Jack, Medium	<a href="#">PEWGHW1000</a>	\$296.86	11	

See Our Website For Current Pricing & Real-Time Stock Availability!

Waveguides



Technical Support  
+1 (949) 261-1920



Same-Day Shipping,  
Even Custom  
Cable Assemblies

# INDEX GUIDE TO APPENDIX

<b>APPENDIX.....</b>	<b>350</b>
<i>PASTERNAK REACH PROGRAM.....</i>	<i>351</i>
<i>PASTERNAK RoHS PROGRAM.....</i>	<i>351</i>
<i>MAILING LIST CHANGES.....</i>	<i>352</i>
<i>BINDING TERMS.....</i>	<i>352</i>
<i>PE PART # INDEX.....</i>	<i>355</i>
<i>CONVERSION TABLES.....</i>	<i>367</i>
<i>MOUNTING HOLES.....</i>	<i>369</i>
<i>CONNECTOR IDENTIFIER.....</i>	<i>370</i>
<i>CONNECTOR FREQUENCY RANGE CHART.....</i>	<i>374</i>

# PASTERNAK ENTERPRISES -- REACH PRODUCT COMPLIANCE PROGRAM

## OUR COMMITMENT

At Infinite Electronics, we maintain a comprehensive REACH compliance program to help customers with their green aspirations. We strive to have accurate and available material content data on all of our products. When data is not yet available, customer requests will be given top priority.

## WHAT IS REACH?

Regulation (EC) No. 1907/2006 of the European Parliament and of the Council of 18 December 2006 is commonly referred to as REACH (Registration, Evaluation, Authorization, and Restriction of Chemicals). The REACH regulation became effective on June 1, 2007 with the objective to improve protection of human health and the environment from exposure to chemicals. Under REACH, there is an obligation to ensure that articles do not contain any of the substances on the REACH Substances of Very High Concern (SVHCs) Candidate list in concentrations greater than 0.1% by weight. SVHCs are substances that may cause cancer or other serious health or environmental effects and thus face potential restriction or outright bans. The SVHC list is updated with additional substances at approximately every six months, thus product declarations must indicate the applicable SVHC release date.

## OUR APPROACH

Infinite Electronics has partnered with Assent Compliance, a world class provider of compliance software and professional support staff, to obtain current material content data on our vast selection of electronic products. Together, we work with our supply chain to routinely collect and analyze this data which enables us to determine the state of compliance for each item we sell. As part of our process integration efforts, we are currently redesigning the way this data can be found on-line so that it is consistent across all brands. Once deployed, we will have a customer self-serve search engine tool to enable real-time creation of part number specific declarations. Until then, customers may request declarations directly from our Assent Compliance partners at [InfiniteElectronicsRequests@assentcompliance.com](mailto:InfiniteElectronicsRequests@assentcompliance.com). Please ensure you that you list all Infinite Electronics part numbers within your request.

# PASTERNAK ENTERPRISES ROHS COMPLIANCE PROGRAM

Lead-free solder is now available for all cable assemblies upon request or online at [www.Pasternack.com](http://www.Pasternack.com).

## OUR COMMITMENT

At Infinite Electronics, we maintain a comprehensive RoHS compliance program to help customers with their green aspirations. We strive to have accurate and available material content data on all of our products. When data is not yet available, customer requests will be given top priority.

## WHAT IS ROHS?

Short for Directive on the restriction of the use of certain hazardous substances in electrical and electronic equipment, RoHS was adopted in February 2003 by the European Union. Now in its third iteration as (EU) Directive 2015/863, RoHS guidelines and legislation are intended to reduce the presence of ten (10) materials deemed hazardous to the environment. To comply, products entering the EU must not have a homogeneous presence of these materials above the following levels by percentage of their weight:

- Lead (Pb) < 0.1%
- Mercury (Hg) < 0.1%
- Cadmium (Cd) < 0.01%
- DEHP < 0.1%
- DBP < 0.1%
- Hexavalent Chromium (CrVI) < 0.1%
- Polybrominated Biphenyls (PBB) < 0.1%
- Polybrominated Diphenyl Esters (PBDE) < 0.1%
- BBP < 0.1%
- DIBP < 0.1%

## OUR APPROACH

Infinite Electronics has partnered with Assent Compliance, a world class provider of compliance software and professional support staff, to obtain current material content data on our vast selection of electronic products. Together, we work with our supply chain to routinely collect and analyze this data which enables us to determine the state of compliance for each item we sell. As part of our process integration efforts, we are currently redesigning the way this data can be found on-line so that it is consistent across all brands. Once deployed, we will have a customer self-serve search engine tool to enable real-time creation of part number specific declarations. Until then, customers may request declarations directly from our Assent Compliance partners at [InfiniteElectronicsRequests@assentcompliance.com](mailto:InfiniteElectronicsRequests@assentcompliance.com). Please ensure you that you list all Infinite Electronics part numbers within your request.



Technical  
Support  
+1 (949) 261-1920



Same-Day Shipping,  
Even Custom  
Cable Assemblies

# MAILING LIST CHANGES

If you receive more than one RF Product Guide with the same name and address, please notify Pasternack and pass the RF Product Guide along to a friend. Also, if you do not require multiple copies to the same company address, contact a sales representative to verify and modify your mailing information. A forms-based communications method to add, delete or modify mailing information is available at [www.pasternack.com](http://www.pasternack.com). By clicking "Contact Us", and then clicking "Remove Name from Mailing List", you may complete the form to request a change to your mailing preferences. In addition, by clicking "RF Product Guide", and then clicking "Request a Printed RF Product Guide", you may add your contact information to our mailing list. Please note service opt-in and opt-out options located on the forms. Alternatively, you may mail, email, telephone or fax Pasternack your request.

## PLACING YOUR ORDER

### ► BY TELEPHONE: 866-PASTERNAK (866-727-8376) US & CANADA, OR 949-261-1920

Our friendly sales representatives are ready to serve you from 5:00am to 5:30pm Pacific Standard Time (PST), Monday through Friday. For the most efficient service, please have ready a list of quantities and part numbers and, if paying by credit card, your MasterCard, VISA, American Express or Discover card. Note: Calls may be recorded or monitored for quality and training purposes.

### ► BY FAX: 949-261-7451

Our fax lines can be accessed 7 days a week, 24 hours a day. Orders received after 4:00pm PST will be promptly processed and shipped the next business day. Please include your daytime phone number and/or email address in case we have any questions about your order.

### ► BY INTERNET: [WWW.PASTERNAK.COM](http://WWW.PASTERNAK.COM) OR EMAIL: [SALES@PASTERNAK.COM](mailto:SALES@PASTERNAK.COM)

Order online 7 days a week, 24 hours a day using our online ordering system. Just search for the items you want and add them to your shopping cart. Internet orders entered after 4:00 pm PST will be promptly processed and shipped the next business day.

### ► BY MAIL: SIMPLY MAIL YOUR ORDER TO: PASTERNAK ENTERPRISES.

17802 FITCH  
PO BOX 16759  
IRVINE, CA 92623-6759 USA

International customers, please see "International Orders" below for additional information.

### TERMS AND CONDITIONS OF SALE:

The following from Pasternack's Binding Terms and Conditions of Sale are provided for your convenience. A complete documentation of the Binding Terms and Conditions of Sale may be found in the back of the RF Product Guide, or on Pasternack's website at <https://www.pasternack.com/t-terms-of-sale.aspx>. Any questions or clarifications may be answered by contacting Customer Service at (+1) 949-261-1920 or by any of the methods listed above.

### NO MINIMUM ORDER REQUIREMENT

### GROUND FREIGHT:

Shipping or freight charges and insurance will be paid by the customer. All sales are made FCA-Shipping Point (as defined by the INCOTERMS 2000) in Irvine, CA USA & Lewisville, TX USA. Shipping or freight charges from Pasternack's Irvine, CA factory are prepaid and added to the invoice or billed collect.

### SAME-DAY SHIPMENT:

Same-day shipment will apply to orders received Monday through Friday, prior to 4:00pm PST.

- All UPS air and surface options
- All FedEx air options (with an approved account number)
- Most other shipping options, including DHL (with an approved account number) and USPS

### COUNTER-TO-COUNTER SHIPPING:

For your urgent order requiring our fastest shipping method, we will place your order on the next available flight from Santa Ana-Orange County John Wayne International Airport (Airport code: SNA) and Dallas/Fort Worth International Airport (Airport Code: DFW) to the destination you specify. Please call for details.

### PAYMENT TERMS:

Pasternack offers a number of convenient payment methods:

For **United States customers**, we offer check, money order, MasterCard, VISA, American Express, and Discover, as well as open account credit to qualified institutions and businesses. Payment must be made in US Dollars.

For **Canadian customers**, we offer all of the above payment options.

For **International customers**, see International Orders.

### OPEN ACCOUNT CREDIT:

Net 30 Days terms are available to businesses, schools and agencies subject to credit approval. Approval can begin by submitting a completed Credit Application, which can be found online at: [www.Pasternack.com/t-CreditApplication.aspx](http://www.Pasternack.com/t-CreditApplication.aspx)

### EFT/WIRE TRANSFERS:

Please contact us for details. We will inform you of the total amount which will include shipping charges and any applicable wire transfer fees. Orders will not be accepted until funds have been received in full.

**WELLS FARGO BANK**  
420 MONTGOMERY ST.  
SAN FRANCISCO, CA 94104 USA  
ACCOUNT NUMBER: 4270 0000 0000 0000 1  
ROUTING NUMBER: 121000248  
SWIFT NUMBER: WFBUS6S

### INTERNATIONAL ORDERS:

In addition to the United States and its territories, Pasternack accepts international orders. All orders of international origin are exported from the US in accordance with the Export Administration Regulations. Diversion contrary to US Law is prohibited. Please see Pasternack's Binding Terms and Conditions of Sale for full details.

Pasternack has international distributors for the following countries:

**Africa:** Namibia, South Africa

**Asia-Pacific:** Australia, China PRC, India, Indonesia, Japan, Malaysia, New Zealand, Singapore, South Korea, Thailand

**Europe:** Austria, Belgium, Czech Republic, Denmark, Finland, France, Germany, Ireland, Italy, Kazakhstan, Luxembourg, Netherlands, Norway, Poland, Portugal, Russia, Slovakia, Spain, Sweden, Switzerland, Turkey, United Kingdom

**Middle East:** Israel

**South America:** Brazil

To access their complete contact information, please see our International Distributors section in this RF Product Guide. (inside back cover)

### INTERNATIONAL SHIPPING CHARGES:

Shipping or freight charges and insurance will be paid by the customer. All sales are made FCA-Shipping Point (as defined by the INCOTERMS 2000) in Irvine, CA USA. We ship orders by UPS, FedEx (with an approved account number), or DHL (with approved account number) with delivery in 2 to 3 days to most locations worldwide.

### INTERNATIONAL TAXES AND DUTIES:

Customer is responsible for duties and taxes.

## BINDING TERMS AND CONDITIONS OF SALE

### 1. SCOPE; CHANGES

The terms and conditions stated herein (this "Agreement") govern all sales of products or services ("products") by Infinite Electronics, Inc. (collectively, "we," "us," "our," or "seller") to you or the entity you represent ("you" or "buyer"). You represent to us that you are lawfully able to enter into contracts (e.g., you are not a minor) and that if you are entering into this Agreement for an entity, such as the company you work for, you represent to us that you have the legal authority to bind that entity. Unless otherwise agreed to in writing by seller's authorized agent, any terms and conditions contained in buyer's purchase order or any other document that are different from or in addition to these terms and conditions are objected to, are rejected, and will not be binding on us. By placing an order for products from us, or by accepting delivery of the products described on the applicable packing slip, bill of lading and/or invoice received with the products, you agree to be bound by and accept these terms and conditions of sale.

We may change the terms and conditions of this Agreement in our sole discretion by posting an updated version of these terms and conditions at this location; provided, however, that the terms and condition of this Agreement in effect as of the date of an applicable order shall continue to govern such order and the products purchased thereunder.

### 2. ORDER ACCEPTANCE

a) Your receipt of an email or other form of order confirmation does not constitute our acceptance of your order or a confirmation of an offer to sell.

b) We reserve the right, without prior notification, to limit the order quantity on any item and/or refuse service to anyone.

c) All orders are subject to review and acceptance by us. You agree to provide complete and accurate contact information in connection with any order submitted to us. Verification of information may be required prior to the acceptance of any order.

d) In the case of pre-stocked finished goods, order acceptance is designated by fulfilling the order. In the case of products requiring post-order processing (including but not limited to design, material purchase, manufacturing or test), order acceptance is designated by performing activities unique to the order.

### 3. ORDER CANCELLATION

a) Orders fully or partially processed by seller may not be cancelled by buyer.

b) Products not previously stocked as finished goods are both Non-Cancelable and Non-Refundable ("NC/NR"). NC/NR products include cable assemblies, special orders, custom orders, orders for non-standard products, products not customarily in stock, scheduled orders requiring special procurements, or orders for products requiring assembly or manufacturing activities prior to shipping (not stored in completed state) as well as purchased services such as special testing or product modifications.

c) In the event of cancellation or other withdrawal of an order for any reason and without limiting any other remedy as a result of such cancellation or other withdrawal, reasonable cancellation or restocking charges, which shall include all expenses then incurred and commitments made by seller, shall be paid by buyer. Buyer's requests to reschedule are subject to acceptance by seller in its sole discretion. Orders may not be rescheduled after the order has been submitted by seller to the shipment carrier.

#### 4. PRICES

a) Orders are billed at the prices (in US Dollars) in effect at the time of shipment.

b) Prices will be as specified within seller's website or as stated in seller's quote / proposal. If no period is specified, quoted prices will be applicable for thirty (30) days.

c) For catalog products, the website contains the most current catalog pricing and is the price reference for such orders. Pricing included in the catalog is for reference only and final pricing is determined by the published website price.

d) For non-catalog products and services, prices cited are based on current costs and are subject to reasonable adjustment on or after the date of acceptance of any purchase order to meet a rise or fall in such costs, as computed on the date of delivery.

e) Prices are subject to change without notice.

f) Prices are exclusive of taxes, impositions and other charges, including: sales, use, excise, value added and similar taxes or charges imposed by any government authority, international shipping charges, forwarding agent's and broker's fees, bank fees, consular fees, document fees and import duties.

#### 5. TERMS OF PAYMENT

a) All payments must be in US Dollars, or will be converted to US Dollars using seller's standard exchange rate at the time of purchase.

b) MasterCard, VISA, Discover, and American Express credit cards, purchase cards and major bank debit cards are accepted. Payment via net thirty (30) days is available to businesses, schools and agencies or as otherwise specified by seller subject to credit approval.

c) For International Orders, MasterCard, VISA, and American Express credit cards are accepted. Payment via open credit account with Net thirty (30) days may be established for companies having three U.S. references accepted to seller. Prepaid Wire Transfer: You can wire the funds to our bank. We will contact you with the total amount, which will include shipping charges and a \$40 wire transfer fee. Orders will not be accepted until funds have been received in full and the Purchase Order (PO) has been received. Notwithstanding anything to the contrary in this Agreement, seller may add or remove payment options in seller's sole discretion.

d) Buyer acknowledges that seller has the right to reassess buyer's creditworthiness from time to time. To the extent such is in accordance with law, in the event there is a decline in buyer's creditworthiness, seller may, upon thirty (30) days written notice, revise the payment terms between the parties. Upon request, buyer shall provide financial data evidencing the buyer's worth in order for seller to determine the creditworthiness of buyer. Such information shall include, but not be limited to, annual reports, balance sheets, and bank records.

e) If buyer is delinquent in its payment obligations, without prejudice to any other remedies available to it by law or in equity, seller may demand immediate payment and at seller's option (i) suspend all further deliveries to be made under the purchase order or any further performance under any other contract with buyer or buyer's affiliates, in which event buyer shall not be released in any respect from its obligations to seller under the purchase order; (ii) recover all costs of collection including but not limited to reasonable attorneys' fees; (iii) repossess the product for which payment has not been made; (iv) charge interest at 1.5% per month on the past due amount, not to exceed the interest percentage allowed by law; and (vii) reassess the credit worthiness of buyer and change any current payment terms. Any discount from seller's rates, if any, shall cease to apply to the delinquent invoice, buyer shall be invoiced for such differences in cost, and shall immediately pay the resulting invoice.

#### 6. TAXES AND DUTIES

a) Any taxes related to the products purchased are the responsibility of buyer (excluding taxes based on seller's net income), unless buyer presents an exemption certificate acceptable to seller and the applicable taxing authorities. If any exemption certificate presented by buyer is held to be invalid, then buyer will pay seller the amount of the tax and any penalties and interest related thereto.

b) If possible, seller will bill taxes as a separate item on the invoice presented to buyer.

c) Sales tax will be charged on product cost and shipping & handling where applicable and required by law. Any sales tax due that is not collected by the seller is the responsibility of the buyer.

d) International orders may be subject to various taxes and duties in the country of destination, all of which are the responsibility of the buyer. This includes sales, use, excise, value added and similar taxes or charges imposed by any government authority, international shipping charges, forwarding agent's and broker's fees, bank fees, consular fees, document fees and import duties.

#### 7. SHIPPING COSTS

Shipping or freight charges and insurance will be paid by the buyer and added to the invoice or billed collect unless specifically stated in the quote or order confirmation based on seller practices or promotions.

#### 8. DELIVERY AND TITLE

a) Unless otherwise agreed to in writing, all products are shipped Incoterms 2010 - FCA Shipping Point. Subject to seller's right of stoppage in transit, delivery of the products to the carrier will constitute delivery to buyer and title and risk of loss will pass to buyer.

b) Seller will make reasonable efforts to initiate shipment and schedule delivery as close as possible to buyer's requested delivery date(s). Buyer acknowledges that delivery dates provided by seller are estimates only and that seller will not be liable for failure to deliver on such dates.

c) Selection of the carrier and delivery route will be made by seller unless specifically designated by buyer.

d) Seller reserves the right to make deliveries in installments. Delay in delivery of one installment will not entitle buyer to cancel any other installment(s). Delivery of any installment of products within thirty (30) days after the date requested will constitute a timely delivery. Delivery of a quantity that varies from the quantity specified shall not relieve buyer of the obligation to accept delivery and pay for the products delivered.

e) Deliveries shall be made during normal business hours Monday through Friday. One attempt to deliver will be made. Should delivery need to be rescheduled, any additional costs incurred for redelivery and/or storage fees will be charged to the buyer. Seller shall use reasonable efforts to make timely delivery but shall be excused from any delays arising out of causes beyond its reasonable control. Any specific delivery dates that may be stated are approximate.

f) If completion of delivery is prevented through no fault of seller, seller may specify a reasonable alternative place of delivery. Buyer agrees that all costs of storage and transport incurred following an initial attempt at delivery are hereby allocated to and imposed upon buyer, and shall be added by seller to the sale price. Delivery may at any time be withheld by seller pending payment of any sum due from the buyer to seller. Seller will return Product via the incoming method unless an alternative method has been indicated on the purchase order or a change authorized by the buyer representative.

g) Deliveries made outside the 48 contiguous States may be subject to modified terms and conditions as stated within the order quote.

#### 9. LIMITED WARRANTY

a) Products manufactured and/or branded by seller are warranted for a period of one year from time of delivery against defects in workmanship or materials or failure to operate as described in product data sheets under normal use. In some cases, the warranty period may exceed one year where a written warranty description specific to a certain product is stated in a contract or posted on a company website, product catalog or user's manual. Accessories and consumable goods such as batteries, chargers and accessory cables are warranted for four months.

b) Products manufactured by seller in accordance with buyer's instructions or specifications provided by seller are warranted for a period of one year from time of delivery against defects in workmanship or materials only under normal use. In some cases, the warranty period may exceed one year where a written warranty description specific to a certain product is stated in a contract or posted on a company website, product catalog or user's manual.

c) Calibration services are warranted for a period of one year from time of completion against defects in workmanship or materials or failure to operate as described in product data sheets under normal use.

d) The warranties set forth in this Section 9 shall not apply to any defect, failure, or damage arising from or in connection with: (i) improper use, or improper or inadequate maintenance and care; (ii) modifications to or repairs of the products performed by any party other than seller; (iii) combination of the products with any other technology, equipment, hardware, software, or other materials; (iv) use of the products in an environment not meeting the operating specifications for the products; (v) failure to properly transport, prepare, and store the products; (vi) acts of God; or (vii) any normal wear and tear or normal environmental degradation.

e) Products solely distributed by seller without alteration carry the warranty of the respective manufacturer only.

f) Seller will at seller's option and in seller's sole discretion, repair, replace or refund any products that are returned under warranty, and Seller's repair, replacement, or refunding of the price paid for a product under warranty shall be seller's sole liability, and buyer's sole remedy, for any breach of the warranties in this Section 9.

g) This warranty applies to the original purchaser only and is not transferable.

h) This warranty does not cover damage incurred during shipment which is the responsibility of the freight shipping company.

i) Buyer will bear the costs of access, de-installation, re-installation and transportation of the products to seller and back to buyer in connection with any warranty claims. Seller will reimburse the costs of transportation to seller and bear the costs of returning the repaired product or sending replacement product to buyer if the product is found to be covered under warranty.

j) Any repair or replacement pursuant to this limited warranty for products manufactured and/or branded by seller shall be warranted against the same defects re-occurring in a period of 12 months from time of delivery of the repaired or replaced product, or until the expiration of the original product warranty, which ever shall be the latter.

k) This limited warranty and remedies are expressly conditioned upon: (i) buyer's payment of the purchase price in full, (ii) buyer giving written notice of the defect, reasonably described, to seller within ten (10) days of the time when buyer discovers or ought to have discovered the defect, (iii) the storage, installation, operation, use, and maintenance of the products in compliance with product instructions, (iv) the existence of proper records of buyer's operation and maintenance of the products during the warranty period, (v) buyer providing seller with a reasonable opportunity to examine the products and the aforementioned records, and (vi) the absence of any unauthorized modification or repair of the products, including without limitation the removal or alternation of any serial numbers or product identifications.

l) THIS WARRANTY IS IN LIEU OF ANY AND ALL OTHER WARRANTIES, WHETHER ORAL, WRITTEN, EXPRESSED, IMPLIED OR STATUTORY. ANY IMPLIED WARRANTIES OF MERCHANTABILITY, FITNESS FOR A PARTICULAR PURPOSE AND NON-INFRINGEMENT ARE HEREBY DISCLAIMED.

#### 10. RETURNS

a) Buyers wishing to return products must first obtain a Return Material Authorization (RMA) number from a Customer Service representative. Unauthorized returns will not be accepted at point of receipt. The RMA number must be printed on the outside of the package in order for it to be received and processed. Merchandise must be shipped prepaid.

b) Seller will determine in seller's sole discretion the appropriate remedies for returned items based on the product's limited warranty and circumstances of the return including a possible refund of purchase price, credit for future purchase, replacement, repair, return to buyer as-is, scrap with consent, and refund of shipping expenses.

c) Items stocked as finished goods and ordered in error must have a Return Material Authorization (RMA) number issued within 30 days of the original order. These parts are eligible for full credit only if the returned products and packaging are in mint and salable condition. A repackaging/restocking charge not to exceed 25% of the sale price may be charged on any products not returned unopened. Under no circumstances will credit be issued after 30 days from date of invoice or for orders exceeding \$500.00 in total value. All freight charges are the responsibility of buyer.

d) Products not previously stocked as finished goods are not returnable unless found to be defective. These include cable assemblies, special orders, custom orders, orders for non-standard products, products requiring assembly or manufacturing activities prior to shipping (not stored in completed state).

e) Defective items must have a Return Material Authorization (RMA) number marked on the package prior to shipping.

f) After 30 days from invoice all merchandise returns for distributed products not manufactured by seller must be handled directly with that manufacturer in accordance with their warranty.

#### 11. ORDER DISCREPANCIES

Claims for shortages, incorrect materials or invoicing errors must be made by buyer in writing within ten (10) business days after receipt of shipment. Claims for nonreceipt of shipment must be made in writing within ten (10) business days after receipt of invoice. No products shall be returned without seller's express instructions. Buyer must provide in writing the order number and describe all defects associated with the order.

#### 12. LIMITATION OF LIABILITIES; INDEMNITY

a) IN NO EVENT WILL SELLER BE LIABLE TO BUYER OR TO ANY THIRD PARTY FOR ANY DELAY, FAILURE TO GIVE NOTICE OF DELAY, LOSS OF USE, SECURITY OR DATA BREACH, LOSS OF REVENUE OR PROFIT OR LOSS OF DATA, RECALL COSTS, SERVICE INTERRUPTIONS, DOWNTIME, TESTING, INSTALLATION, REPLACEMENT, OR REMOVAL COSTS, OR FOR ANY CONSEQUENTIAL, INCIDENTAL, INDIRECT, EXEMPLARY, SPECIAL OR PUNITIVE DAMAGES, WHETHER ARISING OUT OF BREACH OF CONTRACT, TORT (INCLUDING NEGLIGENCE), OR OTHERWISE, REGARDLESS OF WHETHER SUCH DAMAGE WAS FORESEEABLE AND WHETHER OR NOT SELLER HAS BEEN ADVISED OF



Technical Support  
+1 (949) 261-1920



Same-Day Shipping,  
Even Custom  
Cable Assemblies

THE POSSIBILITY OF SUCH DAMAGES. SELLER'S AGGREGATE LIABILITY FOR ANY CLAIMS ARISING OUT OF OR IN CONNECTION WITH THIS AGREEMENT SHALL NOT EXCEED THE PURCHASE PRICE PAID BY BUYER FOR THE PRODUCTS WHICH ARE THE SUBJECT OF THE CLAIM. THE DISCLAIMERS AND LIMITATIONS IN THIS SECTION 12 WILL APPLY NOTWITHSTANDING ANY FAILURE OF ESSENTIAL PURPOSE OF ANY LIMITED REMEDY AND TO THE MAXIMUM EXTENT PERMITTED UNDER APPLICABLE LAW.

b) Buyer shall defend seller from and against any claims, actions, proceedings, or suits brought by any third party (i) alleging infringement of intellectual property rights arising out of or in connection with seller's compliance with buyer's drawings, specifications, requirements or instructions or (ii) arising out of or in connection with the products supplied by seller and incorporated into the buyer's products (each a "Claim") and shall indemnify and hold harmless seller from any costs, liabilities, damages, fines, judgments, or expenses (including reasonable attorneys' fees) arising out of or in connection with any Claim.

### 13. EXPORT COMPLIANCE

a) Items are controlled by the U.S. Government and authorized for export only to the country of ultimate destination for use by the ultimate consignee or end-user(s) identified in the invoice. They may not be resold, transferred, or otherwise disposed of, to any other country or to any person other than the authorized ultimate consignee or end-user(s), either in their original form or after being incorporated into other items, without first obtaining approval from the U.S. Government or as otherwise authorized by U.S. law and regulations. Buyer agrees to comply with all applicable export control laws, restrictions and regulations of the United States and those of the buyer's country, and shall not export, or transfer for the purpose of re-export, any product to any embargoed country or region, including but not limited to Cuba, the Crimean Region of Ukraine, Iran, North Korea, Sudan, and Syria, or to any denied, blocked, or designated person or entity as mentioned in any such United States or EU law or regulation. Buyer represents and warrants that it is not on the Denied Persons, Specially Designated Nationals or Debarred Persons List, as identified by the U.S. Treasury Office of Foreign Asset Control (OFAC) and by the U.S. Department of Commerce, Bureau of Industry and Security (BIS), or any other United States list of prohibited persons; is not owned or controlled by any person that is on one of those lists, or is otherwise prohibited by United States or other law from purchasing the products or services hereunder, and shall notify the seller immediately if buyer's status related to the above changes. Buyer shall be solely responsible to obtain any license to export, re-export or import as may be required. Buyer also agrees that it will not use these products in connection with the proliferation of weapons of mass destruction, including missiles, nuclear, chemical or biological weapons.

b) Seller shall not be liable for delays or refusals by governmental authorities or other authorities to grant licenses or approvals, nor for suspension or revocation thereof, nor for changes in export classification. Buyer must deliver requested information, including requested end-user information, necessary for export licenses to be granted, and necessary for seller to determine if a license or other type of authorization is required.

c) For all custom orders, buyer shall provide seller with export classification information for all buyer property and information (including buyer drawings) delivered to seller in relation to this order. Export classification information includes the applicable export control classification, the country of origin and, for hardware only, the Harmonized Tariff Code. For such custom orders, seller will supply buyer with similar export classification information for products and/or information for which seller has design authority. Buyer and seller will promptly notify the other upon a change in classification information if any occurs prior to delivery.

### 14. GOVERNING LAW; VENUE

a) All matters arising out of or relating to this agreement, or a breach thereof, are governed by and construed in accordance with the internal laws of the State of California without giving effect to any choice or conflict of law provision or rule (whether of the State of California or any other jurisdiction) that would cause the application of the laws of any jurisdiction other than those of the State of California.

b) Any legal suit, action or proceeding arising out of or relating to this agreement, or a breach thereof, will be instituted in the federal or State courts located in the city of Irvine, California or its closest California venue. Each party irrevocably submits to the exclusive jurisdiction of the courts in any legal suit, action or proceeding.

### 15. LEGAL NOTICES

Any legal notice sent to seller from buyer, required or permitted hereunder, will be deemed to have been effectively delivered if in writing and served by personal delivery or sent by registered or certified mail with return receipt requested, postage prepaid, to seller at the primary address specified as seller's place of business.

### 16. INTELLECTUAL PROPERTY

a) Notwithstanding delivery of and the passing of title in any product, nothing in these terms and conditions shall have the effect of granting or transferring to, or vesting in, buyer any intellectual property rights in or to any products.

b) The drawings, text, product depictions, logos, content, product descriptions, and organization and taxonomy of seller's website, catalogue, product guides or other documents and media owned by the seller and of the described content there within are proprietary to the seller and protected by intellectual property laws, including but not limited to United States Copyright law and United States Trademark law. Whether seller owns copyrights in these works or not, their content and the selection, arrangement, coordination and structure of the arranged content there within are the sole property of the seller. Use of the above stated materials does not give anyone the right to modify, reproduce, transmit, publish, publicly display, adapt, or create derivative works or in any way exploit any of the materials without express written permission of the seller.

c) All trademarks referenced in seller's catalog or website or depicted within any seller's documents or digital media, whether registered in United States or other countries, may not be used without permission of the respective trademark owner. This applies to seller owned trademarks as well as those of seller's suppliers.

d) SELLER MAKES NO REPRESENTATION OR WARRANTY THAT THE PRODUCTS (OR BUYER'S USE OR EXPLOITATION THEREOF) WILL NOT INFRINGE ANY INTELLECTUAL PROPERTY RIGHTS.

### 17. SOFTWARE

a) To the extent that the product or services contain or are software, seller hereby grants to buyer a non-exclusive, non-transferable, personal license to use the software and related documentation. Buyer's use conclusively evidences its acceptance of this license. Title to the software shall at all times remain with seller. Buyer agrees that the software, all enhancements, related documentation, and derivative works are, and will remain the sole property of seller and includes valuable trade secrets. Buyer agrees to treat the software and related documentation as confidential and to not copy, reproduce, sub-license, or otherwise disclose the software and related documentation to third parties. Buyer agrees to not disassemble, decompile, reverse engineer, create derivative works from or otherwise translate, customize, localize, modify, add to, or in any way alter, rent, or loan the software or related documentation unless the operation is specifically authorized by law.

b) Third party product software Licenses are separate end user license agreements ("EULA") and not issued pursuant to the above stated personal license.

c) Buyer agrees to defend, indemnify and hold harmless seller from all damages and third party claims arising from unauthorized use or transfer of the software or firmware.

d) If the software is licensed for use in the performance of a U.S. Government prime contract or subcontract, buyer agrees that consistent with FAR 12.211 and 12.212, commercial computer software, computer software documentation and technical data for commercial items are licensed under seller's standard commercial license.

### 18. CONFIDENTIAL INFORMATION

Buyer agrees that all confidential information furnished by or obtained from seller in connection with the sale of items hereunder (including product data and manufacturing process data) shall be adequately safeguarded to prevent unauthorized disclosure. Buyer agrees not to (i) disclose any such information to any other person or entity, or (ii) use such information for any purpose, other than performing authorized activities directly related to the governing contract.

### 19. TOLERANCES

Unless otherwise agreed to in writing by seller, standard tolerances as described on seller's drawings, websites and/or posted catalog datasheets shall apply.

### 20. PRODUCT LINE CHANGES

Product specifications and availability are subject to change without notice. Seller reserves the right to change specifications or discontinue items at seller's sole discretion for any reason whatsoever including, but not limited to changing market conditions, product discontinuation, component unavailability, manufacturing cost changes and errors in advertisements.

### 21. FCC PART 15 AND PART 97 NOTICE

For systems operating within the jurisdiction of the United States Federal Communications Commission (FCC), buyer acknowledges that any amplification device it purchases is intended for use only in a transmission system certified under Part 15, Part 97 or other applicable section of the rules and regulations of the FCC, or that a legal exception to this requirement applies.

### 22. ASSIGNMENT

Buyer shall not assign this Agreement or any order hereunder without the prior written consent of the seller. Any assignment in violation of the foregoing will be void and of no force or effect. Seller may assign this Agreement or any order hereunder in seller's sole discretion and without restriction. This Agreement will be binding upon and inure to the benefit of the parties, their successors, and permitted assigns.

### 23. RELATIONSHIP

Nothing in this Agreement or any product or service orders shall be construed to place the buyer or seller in the relationship of partners or joint ventures, and the buyer and seller shall have no power to obligate or bind the other in any manner whatsoever.

### 24. WAIVER

No waiver by seller of any breach of this Agreement by the buyer shall be considered as a waiver of the subsequent breach of the same or any other provision.

### 25. SEVERABILITY

If any provision or portion of this Agreement shall be adjudged invalid or unenforceable by a court of competent jurisdiction or by operation of any applicable law, that provision or portion of this Agreement shall be deemed omitted and the remaining provisions and portions shall remain in full force and effect.

### 26. LIENS AND TITLE

a) Buyer hereby grants to seller a security interest in any property owned by the buyer (including buyer's beneficial rights to property leased by seller) in the possession of seller or any of seller's affiliates, at any time, to secure all amounts owed by buyer to seller under this Agreement.

b) In the case of repairs or overhauls performed pursuant to this Agreement, buyer grants seller a perfected security interest in all products retained in possession of seller upon which any repair or overhaul services have been performed by seller. Buyer further acknowledges and agrees that, in addition to the security interest and lien expressly granted by buyer to seller, seller shall have a lien on the product retained in possession of seller to the extent otherwise provided by law. Buyer acknowledges that the lien (whether granted by buyer or through the operation of law) for repairs or overhaul shall be for the full value of such work, and shall be superior to any lien or interest in favor of buyer, its parents, affiliates, or subsidiaries, or any other person who has knowledge of this Agreement. To the extent that seller maintains possession of product under repair, buyer agrees that seller is a secured creditor of buyer and has all the rights of a secured creditor.

c) With respect to products sold pursuant to this Agreement, buyer agrees and acknowledges that seller shall retain a security interest in such product, unless and until all payment for such products has been made and all other covenants and agreements of this Agreement have been performed in full. Accordingly, buyer agrees that it will not suffer or permit any lien or encumbrance to be established that effects the title to the product sold by seller pursuant hereto until seller has been paid in full. Buyer agrees that, in the event of buyer's insolvency, or in the event that any petition is filed by or against buyer under Chapter 7 or Chapter 11 of the Bankruptcy Code, seller may, at its discretion, recover all products sold pursuant to this Agreement and/or seek damages or costs under applicable laws.

### 27. STORAGE FEES

A storage fee will be applied monthly up to the maximum allowed by law on all repaired and overhauled units if delivery is not taken within five (5) days of notification.

### 28. FORCE MAJEURE

Notwithstanding anything else in this Agreement, no default, delay, or failure to perform on the part of seller will be considered a breach of this Agreement if such default, delay, or failure to perform is shown to be due to causes beyond reasonable control of seller, including, but not limited to, causes such as strikes, lockouts or other labor disputes, riots, civil disturbances, actions or inactions of governmental authorities or suppliers, epidemics, war, embargoes, severe weather, fire, earthquakes, acts of God or the public enemy, nuclear disasters, or default of a common carrier.

### 29. ENTIRE AGREEMENT; CONSTRUCTION; SURVIVAL

This Agreement sets forth the entire agreement and understanding of the Parties relating to the subject matter herein and supersedes all prior and contemporaneous communications, representations, discussions, and agreements between the Parties with respect to such subject matter. The titles and section headings used in this Agreement are for ease of reference only and shall not be used in the interpretation or construction of this Agreement. No rule of construction resolving any ambiguity in favor of the non-drafting party shall be applied hereto. The word "including", when used herein, is illustrative rather than exclusive and means "including, without limitation." In the event of any termination or expiration of this Agreement, buyer's obligations to pay amounts due hereunder and arising prior to the date of termination or expiration, as well as Sections 9, 12-18, and 21-29 shall survive such termination or expiration.

#### WARNING:

Products in this catalog can expose you to chemicals including phthalates, which are known to the State of California to cause cancer and birth defects or other reproductive harm. For more information, go to [www.P65Warnings.ca.gov](http://www.P65Warnings.ca.gov). For specific products impacted, please visit [www.pasternack.com](http://www.pasternack.com).



# PART NUMBER INDEX

Note: C/R stands for the Column and/or Row location of the specific product on a given page.

Model No.	Page	C/R	Model No.	Page	C/R	Model No.	Page	C/R	Model No.	Page	C/R	Model No.	Page	C/R	Model No.	Page	C/R
CST-400	Web		PE-T1012	305	55	PE-W15TS19001	347	90	PE-W15TF005-24	342	55	PE1008-100PK	Web		PE15A1075	52	26
DBU1	Web		PE-T1013	305	47	PE-W15TS22001	347	91	PE-W15TF005-36	342	56	PE1010	Web		PE15A1076	343	95
EZ-200-NMH-X	228	46	PE-T2000	306	93	PE-W15TW1001	348	17	PE-W62B001	333	64	PE1011	Web		PE15A1077	343	96
EZ-200-TFRP	255	45	PE-T2001	306	88	PE-W15TW1002	348	15	PE-W62B002	333	65	PE1012	Web		PE15A2000	51	50
EZ-200-TM-X	252	30	PE-T2002	305	75	PE-W15TW1003	348	16	PE-W62B003	333	66	PE1013-2	Web		PE15A2001	51	52
EZ-240-4310M-X	209	8	PE-T2003	305	71	PE-W19A001-30	348	42	PE-W62B004	333	67	PE1400	286	29	PE15A2002	51	53
EZ-240-NMH-X	228	47	PE-T2004	306	96	PE-W19A15001	340	41	PE-W62S001-12	345	97	PE1401	286	31	PE15A2003	51	51
EZ-240-OMI-RA-X	233	18	PE-T2005	305	64	PE-W19B001	332	54	PE-W62S001-3	345	98	PE1402	286	30	PE15A2004	51	54
EZ-240-SM-RA-X	231	82	PE-T2006	306	68	PE-W19C001	332	55	PE-W62S001-6	345	99	PE1406	Web		PE15A2005	51	55
EZ-240-SM-X	236	31	PE-T2007	306	79	PE-W19CA001	329	63	PE-W62S001-9	345	96	PE1513	50	25	PE15A3004	48	9
EZ-240-TM-X	252	31	PE-T2008	306	85	PE-W19CA002	329	64	PE-W62S002-12	345	92	PE1514	50	23	PE15A3005	48	18
EZ-400-716M-RA-X	210	51	PE-T2009	305	61	PE-W19CP001-10	334	27	PE-W62S002-6	345	90	PE1516	50	30	PE15A3007	48	8
EZ-400-716M-X	210	36	PE-T2010	305	76	PE-W19CP001-20	334	26	PE-W62S002-9	345	91	PE1517	50	27	PE15A3008	48	19
EZ-400-BM-X	214	88	PE-T2011	306	2	PE-W19CP003-10	334	24	PE-W62S005-12	341	18	PE1518	50	28	PE15A3009	48	35
EZ-400-FM-75	259	76	PE-T2012	305	72	PE-W19CP003-20	334	25	PE-W62S005-24	341	19	PE1519	50	34	PE15A3014	48	14
EZ-400-NF-BH	231	66	PE-T2013	305	62	PE-W19CP003-30	343	23	PE-W62S005-36	341	20	PE1520	50	35	PE15A3015	48	15
EZ-400-NMC-2-D	228	39	PE-T2014	305	65	PE-W19S001-1	345	63	PE-W62T001-12	342	57	PE1521	50	36	PE15A3016	48	29
EZ-400-NMC-75-X	262	21	PE-T2015	306	89	PE-W19S001-3	345	66	PE-W62T005-24	342	58	PE1522	50	38	PE15A3017	48	44
EZ-400-NMH-PL-X	228	48	PE-T2017	306	1	PE-W19S001-6	345	64	PE-W62T005-36	342	59	PE1523	50	41	PE15A3018	48	42
EZ-400-NMH-RA-X	229	85	PE-T2018	306	86	PE-W19S001-9	345	65	PE-W62T005-6	342	26	PE1524	50	37	PE15A3019	48	43
EZ-400-NMH-X	228	49	PE-T2019	306	87	PE-W19T001	346	37	PE-W75B001	333	68	PE1525	50	31	PE15A3020	48	45
EZ-400-TM-X	252	32	PE-T2020	306	81	PE-W19TS2001	347	92	PE-W75B002	333	69	PE1526	50	24	PE15A3021	48	11
EZ-600-716M-X	210	37	PE-T2021	306	92	PE-W19TS2001	347	93	PE-W75S001-12	345	2	PE1603	83	38	PE15A3021D	48	12
EZ-600-NF-BH	231	67	PE-T2022	306	83	PE-W19TS2002	347	94	PE-W75S001-3	345	99	PE1604	83	39	PE15A3022	48	13
EZ-600-NF-X	230	29	PE-T2023	306	97	PE-W19TW1002	348	18	PE-W75S001-6	345	2	PE1605	83	34	PE15A3023	48	7
EZ-600-NMC-2-D	228	40	PE-T2024	306	84	PE-W19TW1003	348	19	PE-W75S001-9	345	3	PE1606A	83	21	PE15A3024	48	47
EZ-600-NMC-2-D	229	86	PE-T2025	306	82	PE-W229AN001	326	47	PE-W75S001A-6	345	98	PE1608	83	23	PE15A3025	48	49
EZ-600-NMH-X	228	50	PE-W10A002-30	348	40	PE-W229AN001	326	47	PE-W75S001A-12	341	21	PE1610	83	20	PE15A3026	48	5
EZ-600-TM-X	252	33	PE-W10A001	340	38	NF-10	324	67	PE-W75S001A-24	341	22	PE1611	83	24	PE15A3027	48	10
EZ-SW396-7.16MC	209	31	PE-W10B001	332	48	PE-W229AN001	326	68	PE-W75S005-36	341	23	PE1612	83	26	PE15A3028	48	36
EZ-SW396-NMC	229	83	PE-W10C001	329	57	PE-W22AT001-30	348	43	PE-W75S005-6	342	61	PE1614	83	27	PE15A3029	48	37
EZ-SW540-7.16MC	209	32	PE-W10CA002	329	58	PE-W22AT001	340	42	PE-W75T005-24	342	62	PE1615	83	28	PE15A3025	48	63
EZ-SW540-NMC	228	42	PE-W10CA003	329	56	PE-W22AT002	340	43	PE-W75T005-36	342	63	PE1616	83	29	PE15A3026	48	64
FT-396	Web		PE-W10CP001-10	334	13	PE-W22B001	332	58	PE-W90B001	333	70	PE1617	83	32	PE15A3027	48	83
LMR-100A-PVC	194	17	PE-W10CP001-20	334	11	PE-W22C001	332	59	PE-W90B002	333	71	PE1618	83	33	PE15A3028	48	84
LMR-195	194	18	PE-W10CP003-10	334	14	PE-W22C002	329	66	PE-W90B003A	333	72	PE1619	83	18	PE15A3029	48	92
LMR-195-LPL	Web		PE-W10CP003-20	334	12	PE-W22C003	334	39	PE-W90S001-12	346	14	PE1620	83	19	PE15A3030	48	97
LMR-200-FR	194	19	PE-W10PS1001	343	10	PE-W22C004-20	343	20	PE-W90S001-3	346	15	PE1621	83	25	PE15A3031	48	32
LMR-200	194	20	PE-W10TR1001	346	33	PE-W22PS1001	343	14	PE-W90S001-6	346	10	PE1622	83	36	PE15A3032	48	22
LMR-200-FR	194	21	PE-W10TS1201A	347	86	PE-W22S001-12	345	72	PE-W90S001-12	346	12	PE1S1001	300	2	PE15A3033	48	20
LMR-200-UF	194	22	PE-W10TS15001	347	87	PE-W22S001-3	345	69	PE-W90S001A-9	345	5	PE1S1002	300	1	PE15A3034	48	21
LMR-240	194	23	PE-W10TS19001	347	88	PE-W22S001-6	345	70	PE-W90S002-12	346	15	PE1S1900	300	4	PE15A3035	48	31
LMR-240-DB	194	24	PE-W10TW1001	348	10	PE-W22S001-9	345	71	PE-W90S002-3	346	7	PE1S1901	300	3	PE15A3036	48	4
LMR-240-UF	194	25	PE-W10TW1002	348	8	PE-W22S001-12	345	73	PE-W90S002-6	346	11	PE1S1902	300	5	PE15A3037	48	6
LMR-400	194	26	PE-W112S001	333	73	PE-W22S001-3	345	68	PE-W90S002-12	346	13	PE1S1903	300	6	PE15A3038	48	8
LMR-400-75	194	1	PE-W112B001	333	73	PE-W22S005-6	341	3	PE-W90S005-12	341	24	PE1S1904	300	7	PE15A3039	48	9
LMR-400-DB	195	27	PE-W112B002	333	74	PE-W22T005-12	342	43	PE-W90S005-24	341	26	PE1S1905	300	8	PE15A3020	48	86
LMR-400-UF	195	28	PE-W112S001-3	346	16	PE-W22T005-24	342	44	PE-W90S005-36	341	28	PE1D2000	334	4	PE15A3021	48	85
LMR-500	195	29	PE-W112S001-6	346	19	PE-W22T005-6	342	42	PE-W90S005-6	341	29	PE1D2001	334	3	PE15A3022	48	81
LMR-500-DB	195	30	PE-W112S001-9	346	20	PE-W22T005-12	342	45	PE-W90S005-12	341	31	PE1D2002	333	2	PE15A3023	48	93
LMR-600	195	31	PE-W112S001-12	346	21	PE-W22T005-24	342	46	PE-W90S005-24	341	32	PE1D2003	333	1	PE15A3024	48	95
LMR-600-FR	194	27	PE-W112S005-12	341	31	PE-W22T005-36	342	47	PE-W90S005-36	341	34	Web			PE15A3025	48	96
LMR-SW396	195	33	PE-W112S005-24	341	33	PE-W22TW1001	348	24	PE-W90T005-24	342	66	PE1S1904	300	8	PE15A3026	48	90
LMR-SW540	195	34	PE-W112S005-36	341	35	PE-W22TW1002	348	21	PE-W90T005-36	342	68	PE1S1905	300	7	PE15A3027	48	86
PE-020SR	197	80	PE-W112S006-12	341	30	PE-W22TW1003	348	22	PE-W90T006-12	342	63	PE1S1001	334	9	PE15A3028	48	77
PE-034SR	197	81	PE-W112S006-24	341	32	PE-W28A001	340	44	PE-W90T006-24	342	65	PE1S1002	334	8	PE15A3029	48	1
PE-047SR	197	82	PE-W112S006-36	341	34	PE-W28B001	332	59	PE-W90T006-36	342	67	PE1S1003	334	7	PE15A3030	48	66
PE-047SR	197	83	PE-W112T005-12	342	70	PE-W28B002	332	60	SFP-250	Web		PE1S1004	334	6	PE15A3031	48	67
PE-125FAC	195	35	PE-W112T005-24	342	71	PE-W28B003	332	61	SFP-500	Web		PE1S1005	334	5	PE15A3032	48	68
PE-125FHC	195	36	PE-W112T005-36	342	72	PE-W38A002	340	45	TC-100-SM	235	82	PE1S1006	81	80	PE15A3033	48	69
PE-145FHC	195	37	PE-W112T006-12	342	69	PE-W28C002-10	334	33	TC-100-TM	251	7	PE1S1007	81	1	PE15A3034	48	71
PE-118SR	197	84	PE-W112T006-24	342	73	PE-W28C003-10	334	32	TC-100-UM	251	7	PE15A1002	52	6	PE15A3035	48	72
PE-195TC	195	48	PE-W112T006-36	342	73	PE-W28C003-20	334	32	TC-195-NMH-RA-D	228	67	PE15A1003	52	15	PE15A3036	48	72
PE-151TC	195	47</															

# PART NUMBER INDEX

Note: C/R stands for the Column and/or Row location of the specific product on a given page.

Model No.	Page	C/R	Model No.	Page	C/R	Model No.	Page	C/R	Model No.	Page	C/R	Model No.	Page	C/R	Model No.	Page	C/R			
PE15A5053	55	51	PE1V11004	301	33	PE2056A	273	85	PE20DV1065	Web	PE20C1071	268	12	PE3015	184	71	PE3285	118	92	
PE15A5053F	53	52	PE1V11005	301	34	PE2056B	273	86	PE20DV1067	Web	PE20C1072	268	17	PE3020	189	69	PE3288	133	15	
PE15A5054	54	1	PE1V11006	301	35	PE2058	272	76	PE20DV1068	Web	PE20C1073	269	29	PE3023	177	17	PE3289	118	93	
PE15A5054F	54	2	PE1V11007	301	36	PE2059	273	79	PE20DV1069	Web	PE20C1074	269	23	PE3025	111	18	PE3271	142	43	
PE15A5055	53	36	PE1V11008	301	37	PE2061	286	11	PE20S0001	286	13	PE20C1075	268	13	PE3034	128	83	PE3272	133	10
PE15A5056	53	37	PE1V11009	301	38	PE2062	286	9	PE20S0002	286	15	PE20C1076	268	18	PE3038	115	27	PE3273	142	41
PE15A5057	53	40	PE1V11010	301	39	PE2063	284	17	PE20S0003	286	14	PE20C1100	270	84	PE3041	189	86	PE3275	142	42
PE15A5058	53	40	PE1V11011	301	40	PE2064	284	19	PE20S0004	286	12	PE20C1101	270	89	PE3042	122	19	PE3277	Web	44
PE15A5059	56	60	PE1V11012	301	41	PE2065	284	23	PE20S0005	286	17	PE20C1102	270	63	PE3044	111	19	PE3278	142	44
PE15A5060	56	61	PE1V11013	301	42	PE2066	284	20	PE20S0006	286	16	PE20C1103	270	75	PE3047	110	83	PE3280	123	19
PE15A5061	53	51	PE1V11014	301	43	PE2067	284	18	PE20S0007	286	18	PE20C1104	270	85	PE3050	161	12	PE3282	123	17
PE15A5062	56	67	PE1V11015	301	44	PE2068	284	21	PE20S0008	286	22	PE20C1105	270	90	PE3051	151	17	PE3285	123	18
PE15A5063	56	68	PE1V11016	301	45	PE2070	284	27	PE20S0009	286	21	PE20C1106	270	93	PE3052	112	36	PE3288	123	21
PE15A5064	56	70	PE1V11017	301	46	PE2074	285	76	PE20S0010	286	20	PE20C1107	270	96	PE3056	150	79	PE3290	116	46
PE15A5065	53	38	PE1V11018	301	47	PE2077	284	43	PE20S0011	286	19	PE20C1108	270	58	PE3057	183	59	PE3291	143	72
PE15A5066	56	71	PE1V11019	301	48	PE2078	284	42	PE20S0012	286	23	PE20C1109	270	80	PE3058	153	82	PE3293	116	47
PE15A5067	56	72	PE1V11020	301	49	PE2078A	284	44	PE20S0013	286	22	PE20C1110	270	88	PE3061	116	6	PE3295	116	45
PE15A5068	56	75	PE1V11021	301	50	PE2080	285	83	PE20S0014	286	25	PE20C1111	270	98	PE3062	124	74	PE3297	116	48
PE15A5069	56	76	PE1V11022	301	51	PE2081	284	40	PE20S0015	286	26	PE20C1112	270	92	PE3067	109	40	PE3299	116	58
PE15A5070	56	77	PE1V11023	301	52	PE2082	284	16	PE20S0016	286	28	PE20C1113	271	26	PE3071	126	28	PE3301	Web	58
PE15A5071	56	80	PE1V11024	301	53	PE2083	284	24	PE20S0017	286	27	PE20C1120	270	88	PE3074	179	71	PE3302	143	78
PE15A5072	56	81	PE1V11025	301	54	PE2084	284	22	PE20S0019	286	91	PE20C1124	268	6	PE3075	109	61	PE3304	116	57
PE15A5073	56	84	PE1V11026	301	55	PE2088	285	74	PE20S0020	285	96	PE20C1125	268	7	PE3076	144	97	PE3306	116	59
PE15A5077	53	62	PE1V11027	301	56	PE2089	285	85	PE20S0021	286	27	PE20C1126	268	8	PE3078	116	76	PE3308	183	78
PE15A5079	53	76	PE1V12001	302	71	PE2090	285	89	PE20S0022	285	72	PE20C1127	268	1	PE3080	131	71	PE3309	116	51
PE15A5080	53	77	PE1V12002	302	72	PE2091	286	5	PE20S0023	286	3	PE20C1133	268	5	PE3081	109	64	PE3311	Web	58
PE15A5081	55	28	PE1V12003	302	73	PE2092	285	73	PE20S0024	285	93	PE20C1134	268	2	PE3082	109	70	PE3314	116	50
PE15A5082	55	27	PE1V12004	302	74	PE2093	285	88	PE20S0025	285	75	PE20C1135	268	3	PE3083	115	26	PE3316	116	52
PE15A5083	53	59	PE1V12005	302	75	PE2094	285	94	PE20S0026	285	15	PE20C1140	272	67	PE3085	111	81	PE3318	143	81
PE15A5087	53	59	PE1V12006	302	76	PE2095	286	4	PE20S0027	286	11	PE20C1141	273	81	PE3087	109	49	PE3319	148	33
PE15A5088	53	58	PE1V12007	302	77	PE2099	286	39	PE20S0028	286	12	PE20C1142	273	82	PE3088	116	7	PE3320	148	32
PE15A5089	57	96	PE1V12008	302	78	PE2201	270	57	PE20S0029	285	13	PE20C1143	273	80	PE3089	155	31	PE3321	143	73
PE15A6002	50	45	PE1V13000	302	79	PE2202	270	66	PE20S0030	286	16	PE20C1144	272	72	PE3093	150	98	PE3323	143	70
PE15A6007	51	47	PE1V13001	302	80	PE2203	270	79	PE20S0031	286	17	PE20C1145	272	73	PE3094	112	40	PE3325	110	74
PE15A6008	51	48	PE1V13002	302	81	PE2204	270	82	PE20S0032	286	17	PE20C1146	272	35	PE3095	115	28	PE3327	Web	58
PE15A6012	51	49	PE1V13003	302	82	PE2205	270	91	PE20S0033	270	74	PE20C1147	272	33	PE3097	122	9	PE3333	150	99
PE15A6015	51	49	PE1V13004	302	83	PE2206	270	95	PE20S0034	270	87	PE20C1148	272	36	PE3098	117	64	PE3334	Web	58
PE15A63000	52	19	PE1V13005	303	84	PE2207	270	97	PE20S0035	268	40	PE20C1149	272	34	PE3100	109	87	PE3335	139	56
PE15A63001	52	20	PE1V13006	303	85	PE2208	270	61	PE20S0036	268	41	PE20C1150	272	32	PE3102	116	3	PE3337	133	53
PE15A63002	52	21	PE1V13007	303	86	PE2209	270	61	PE20S0037	270	67	PE20C1151	273	88	PE3103	110	3	PE3341	188	66
PE15A63003	52	22	PE1V13008	303	87	PE2210	270	68	PE20S0038	270	60	PE20C1152	273	89	PE3104	Web	3	PE3343	113	53
PE15A63004	52	23	PE1V13009	303	88	PE2211	270	83	PE20S0039	272	66	PE20C1153	273	90	PE3108	117	88	PE3344	148	42
PE15A63005	52	24	PE1V13010	303	89	PE2212	270	94	PE20S0040	272	70	PE20C1154	273	91	PE3109	165	24	PE3345	144	13
PE15A63006	52	24	PE1V13011	303	89	PE2213	269	51	PE20S0041	272	74	PE20C1155	273	93	PE3112	Web	7	PE3346	Web	58
PE15A63007	52	25	PE1V13012	303	90	PE2215	270	73	PE20S0042	272	78	PE20C1156	273	92	PE3116	110	77	PE3347	160	79
PE15A63008	52	29	PE1V13013	303	91	PE2216	271	21	PE20S0043	271	21	PE20C1157	273	94	PE3117	138	52	PE3348	132	60
PE15A63009	52	30	PE1V13014	303	93	PE2218	271	23	PE20S0044	272	77	PE20C1158	273	95	PE3120	113	55	PE3349	171	44
PE15A63010	52	31	PE1V13015	303	94	PE2219	271	24	PE20S0045	269	53	PE20C1159	273	96	PE3121	147	82	PE3351	111	21
PE15A63011	52	32	PE1V14000	302	57	PE2220	271	27	PE20S0046	271	1	PE20C1161	273	87	PE3122	Web	74	PE3352	149	57
PE15A7000	56	82	PE1V14001	302	58	PE2221	271	28	PE20S0047	271	18	PE20C1162	273	81	PE3123	176	74	PE3353	146	76
PE15A8000	50	29	PE1V14002	302	59	PE2222	271	29	PE20S0048	272	2	PE20C1163	273	33	PE3130	Web	7	PE3355	110	73
PE15A8001	50	28	PE1V14003	302	60	PE2223	271	31	PE20S0049	271	3	PE20C1164	273	32	PE3133	112	77	PE3357	115	31
PE15A8004	50	32	PE1V14004	302	61	PE2224	271	31	PE20S0050	271	19	PE20C1165	273	34	PE3134	116	79	PE3358	148	32
PE15A8005	50	33	PE1V14005	302	62	PE2226	269	31	PE20S0051	271	4	PE20C1166	273	30	PE3137	149	54	PE3361	146	79
PE15A8006	50	39	PE1V14006	302	63	PE2227	269	35	PE20S0052	271	16	PE20C1167	273	32	PE3138	147	91	PE3362	189	91
PE15A8007	50	40	PE1V14007	302	64	PE2228A	269	32	PE20S0053	271	5	PE20C1168	273	26	PE3139	176	75	PE3364	112	41
PE15A80000	50	44	PE1V14008	302	65	PE2230	269	36	PE20S0054	271	6	PE20C1169	273	28	PE3141	161	97	PE3365	117	78
PE15A80010	50	43	PE1V14009	302	66	PE2234	269	38	PE20S0055	271	20	PE20C1170	273	20	PE3143	126	23	PE3366	145	77
PE15A8002	50	44	PE1V14010	302	66	PE2235	269	37	PE20S0056	271	8	PE20C1171	273	10	PE3145	115	18	PE3367	112	30
PE15A8003	50	45	PE1V14011	302	67	PE2236	269	34	PE20S0057	271	10	PE20C1172	273	11	PE3147	109	61	PE3368	145	73
PE15A9000	51	79	PE1V15000	302	68	PE2238	269	33	PE20S0058	271	11	PE20C1173	273	12	PE3149	161	82	PE3369	148	32
PE15A9002	52	7	PE1V15001	302	69	PE2240	269	24	PE20S0059	271	12	PE20C1174	273	12	PE3152	161	11	PE3370	111	24
PE15B5000	48	3	PE1V13000	303	95	PE2242	269	46	PE20S0060	271	22	PE20C1175	273	13	PE3154	154	14	PE3371	Web	58
PE15B5001	48	2	PE1V13001	303	96	PE2242A	269	47	PE20S0061	271	13	PE20C1176	273	13						

# PART NUMBER INDEX

Note: C/R stands for the Column and/or Row location of the specific product on a given page.

Model No.	Page	C/R	Model No.	Page	C/R	Model No.	Page	C/R	Model No.	Page	C/R	Model No.	Page	C/R	Model No.	Page	C/R			
PE3468	167	61	PE3679	162	21	PE3349	110	87	PE33476	172	95	PE34138	125	94	PE34281	Web		PE34497	172	80
PE3472	122	63	PE3681	158	23	PE3350	117	79	PE33479	126	2	PE34140	125	95	PE34282	173	50	PE34498	Web	
PE3476	122	10	PE3684	Web		PE3353	Web		PE33481	145	17	PE34141	161	14	PE34283	Web		PE34499	Web	
PE3477	122	14	PE3686	128	87	PE3354	Web		PE33482	162	27	PE34142	125	93	PE34284	Web		PE34500	Web	
PE3478	141	6	PE3688	110	75	PE3356	151	13	PE33491	115	37	PE34143	145	23	PE34285	Web		PE34501	173	15
PE3480	189	3	PE3693-12	Web		PE3357	143	77	PE33502	170	41	PE34144	Web		PE34289	Web		PE34502	Web	
PE3481	146	66	PE3694	117	71	PE3358	148	30	PE33516	147	30	PE34146	Web		PE34291	127	67	PE34503	174	29
PE3483	148	27	PE3696	141	95	PE3359	151	16	PE33518	168	83	PE34148	Web		PE34299	Web		PE34504	Web	
PE3485	177	5	PE3699	150	69	PE3360	116	39	PE33519	145	1	PE34149	165	10	PE34292	Web		PE34505	Web	
PE3487	125	80	PE3698	132	7	PE3361	151	11	PE33521	Web		PE34150	128	79	PE34293	Web		PE34507	Web	
PE3488	128	80	PE3699	122	22	PE3363	124	64	PE33523	141	9	PE34151	Web		PE34296	Web		PE34508	Web	
PE3490	Web		PE3704	147	86	PE3365	Web		PE33525	124	72	PE34152	Web		PE34297	162	19	PE34509	Web	
PE3492	147	3	PE3706	150	80	PE3366	Web		PE33527	124	71	PE34153	Web		PE34299	161	6	PE34510	Web	
PE3494	151	14	PE3713	160	83	PE3367	151	32	PE33528	133	33	PE34154	Web		PE34303	Web		PE34511	174	33
PE3495	109	43	PE3714	127	52	PE3714	Web		PE33529	Web		PE34155	145	24	PE34305	Web		PE34518	Web	
PE3496	124	73	PE3715	150	78	PE3715	167	63	PE33530	128	90	PE34156	Web		PE34307	Web		PE34520	Web	
PE3497	177	5	PE3721	124	8	PE3721	127	61	PE33532	132	32	PE34157	145	25	PE34309	Web		PE34532	Web	
PE3498	177	12	PE3722	152	54	PE3722	127	68	PE33534	128	89	PE34158	Web		PE34311	162	20	PE34534	Web	
PE3499	126	1	PE3724	Web		PE3724	131	65	PE33535	177	15	PE34159	Web		PE34313	161	7	PE34536	Web	
PE3500	147	87	PE3726	126	24	PE3726	128	94	PE33536	133	30	PE34160	Web		PE34315	Web		PE34538	116	40
PE3501	Web		PE3733	158	18	PE3733	127	60	PE33537	115	38	PE34161	128	93	PE34316	179	63	PE34544	131	79
PE3502	Web		PE3735	117	70	PE3735	160	82	PE33539	116	41	PE34162	109	55	PE34317	161	23	PE34550	96	56
PE3504	179	42	PE3736	152	69	PE3736	127	71	PE33541	132	82	PE34163	Web		PE34319	161	5	PE34572	96	54
PE3505	177	5	PE3739	124	8	PE3739	145	63	PE33543	128	85	PE34164	Web		PE34321	Web		PE34573	Web	
PE3508	110	78	PE3740	162	29	PE3740	131	61	PE33545	133	28	PE34166	108	54	PE34322	157	82	PE34574	96	57
PE3510	148	38	PE3741	Web		PE3741	139	53	PE33546	Web		PE34168	Web		PE34324	Web		PE34575	157	85
PE3511	160	78	PE3743	184	77	PE3743	128	98	PE33547	165	11	PE34169	145	28	PE34331	151	37	PE34576	96	55
PE3512	148	34	PE3747	179	62	PE3747	125	99	PE33548	Web		PE34170	109	56	PE34351	159	50	PE34578	96	64
PE3513	148	41	PE3749	109	47	PE3749	127	53	PE33552	Web		PE34171	144	14	PE34357	122	91	PE34579	Web	
PE3514	160	75	PE3750	122	5	PE3750	124	75	PE33554	144	19	PE34173	Web		PE34359	122	92	PE34580	96	62
PE3515	177	5	PE3751	124	8	PE3751	145	41	PE33559	173	24	PE34174	Web		PE34361	144	15	PE34581	182	41
PE3516	117	65	PE3758	165	18	PE33001	143	86	PE33556	173	24	PE34175	109	59	PE34361	156	76	PE34582	96	65
PE3517	117	76	PE3759	161	9	PE33003	147	2	PE33557	Web		PE34176	144	16	PE34374	142	46	PE34583	183	61
PE3518	112	49	PE3764	Web		PE33009	Web		PE33559	Web		PE34177	109	53	PE34396	156	56	PE34584	96	63
PE3519	143	76	PE3765	174	38	PE33013	179	61	PE33561	Web		PE34178	145	22	PE34397	156	55	PE34585	Web	
PE3520	Web		PE3769	154	26	PE33014	159	51	PE33563	Web		PE34179	161	13	PE34398	151	40	PE34586	Web	
PE3521	165	22	PE3775	160	76	PE33018	139	62	PE33565	Web		PE34180	147	98	PE34405	165	17	PE34587	184	68
PE3522	112	50	PE3776	108	37	PE33021	153	27	PE33567	Web		PE34181	128	84	PE34406	156	28	PE34588	Web	
PE3523	Web		PE3777	184	83	PE33024	167	15	PE33574	Web		PE34182	147	1	PE34407	Web		PE34589	186	64
PE3524	170	32	PE3778	146	80	PE33053	184	72	PE33580	174	30	PE34183	Web		PE34408	155	27	PE34590	Web	
PE3528	188	77	PE3779	148	39	PE33068	139	44	PE33583	115	30	PE34184	147	5	PE34409	117	87	PE34591	183	66
PE3531	Web		PE3780	158	14	PE33071	175	65	PE33586	188	89	PE34185	Web		PE34410	Web		PE34592	96	66
PE3534	Web		PE3781	133	11	PE33073	163	60	PE33589	189	69	PE34186	146	63	PE34411	117	85	PE34595	Web	
PE3535	154	22	PE3782	125	96	PE33084	168	78	PE33615	131	53	PE34188	146	64	PE34412	147	94	PE34598	118	95
PE3539	147	7	PE3783	110	92	PE33088	113	54	PE33619	173	16	PE34191	147	94	PE34413	117	80	PE34599	118	96
PE3541	171	75	PE3784	168	78	PE33091	145	21	PE33643	Web		PE34192	165	29	PE34414	165	29	PE34600	Web	
PE3543	183	67	PE3796	184	74	PE33120	165	13	PE33644	189	85	PE34193	147	95	PE34415	117	83	PE34604	Web	
PE3544	179	55	PE3797	126	27	PE33121	172	93	PE33645	174	36	PE34194	128	88	PE34416	154	12	PE34614	151	36
PE3545	Web		PE3799	151	22	PE33123	109	63	PE33646	189	90	PE34195	149	49	PE34417	Web		PE34618	Web	
PE3548	152	52	PE3800	161	15	PE33130	109	45	PE33647	173	21	PE34197	148	24	PE34418	155	30	PE34626	132	82
PE3551	177	7	PE3803	183	63	PE33143	171	68	PE33649	Web		PE34198	Web		PE34419	117	82	PE34666	123	34
PE3553	151	18	PE3806	Web		PE33144	122	90	PE33650	171	52	PE34199	Web		PE34420	155	33	PE34674	Web	
PE3559	99	11	PE3807	108	38	PE33145	147	14	PE33652	171	53	PE34201	149	53	PE34421	Web		PE34679	182	2
PE3561	152	68	PE3808	173	22	PE33158	168	79	PE33654	172	87	PE34201	Web		PE34422	154	10	PE34681	188	59
PE3562	141	2	PE3809	153	72	PE33165	171	55	PE33656	172	88	PE34202	148	25	PE34423	117	72	PE34683	188	60
PE3568	143	71	PE3810	152	57	PE33175	171	65	PE33657	152	58	PE34203	Web		PE34424	139	57	PE34685	188	61
PE3570	124	65	PE3814	147	7	PE33176	168	84	PE33658	Web		PE34204	148	46	PE34425	117	74	PE34686	167	53
PE3571	Web		PE3815	139	45	PE33178	133	29	PE33660	Web		PE34205	126	26	PE34427	117	68	PE34687	188	62
PE3572	147	6	PE3816	111	25	PE33179	166	28	PE33662	Web		PE34206	Web		PE34428	139	46	PE34689	188	63
PE3573	147	85	PE3818	147	4	PE33186	147	64	PE33664	174	27	PE34207	128	31	PE34429	117	66	PE34690	Web	
PE3574	168	78	PE3819	161	92	PE33187	165	16	PE33666	174	64	PE34208	Web		PE34430	117	69	PE34691	Web	
PE3577	117	73	PE3820	161	93	PE33189	112	31	PE33668	Web		PE34209	160	67	PE34431	117	69	PE34693	123	31
PE3578	165	12	PE3821	149	51	PE33191	170	33	PE33669	154	13	PE34210	126	30	PE34432	139	55	PE34694	188	65
PE3580	184	78	PE3822	149	52	PE33196	186	20	PE33670	171	69	PE34211	160	86	PE34433	Web		PE34696	Web	
PE3581	188	79	PE3823	150	95	PE33197	186	13	PE33672	171	70	PE34212	Web		PE34434	115	25	PE34701	187	56
PE3582	109	52	PE3824	150	96	PE33208	Web		PE33673	154	20	PE34213	161	90	PE34435	Web		PE34703	187	57
PE3583	109	60	PE3825	121	26	PE33236	124	76	PE33674	172	75	PE34214	Web		PE34436	115	35	PE34705	187	58
PE3584	158	58	PE3826	151	28	PE33237	168	14	PE33675	172	76	PE34215	Web		PE34437	114	52	PE34707	187	59
PE3588	171	58	PE3827	125	97	PE33254	165	14	PE33676	172	76	PE34216	Web		PE34438	Web		PE34716	127	43
PE35																				

# PART NUMBER INDEX

Note: C/R stands for the Column and/or Row location of the specific product on a given page.

Model No.	Page	C/R	Model No.	Page	C/R	Model No.	Page	C/R	Model No.	Page	C/R	Model No.	Page	C/R	Model No.	Page	C/R	
PE35154	170	28	PE36123	Web		PE37828	Web		PE38140/BL	Web	114	98	PE39344B	Web		PE39373	Web	
PE35207	156	66	PE36124	Web		PE37840	185	1	PE38140/GR	Web	114	99	PE39344C	104	66	PE39374	Web	43
PE35208	157	38	PE36125	Web		PE37842	186	2	PE38140/RD	Web	114	1	PE39344D	164	67	PE39375	155	60
PE35209	156	67	PE36126	Web		PE37844	Web		PE38140/WH	Web	114	2	PE39344E	164	68	PE39376	163	52
PE35210	151	39	PE36127	186	12	PE37845	185	94	PE38140/YW	Web	114	3	PE39344F	164	69	PE39377	182	26
PE35212	151	41	PE36128	Web		PE37846	185	96	PE38141/BK	Web	113	59	PE39344G	164	70	PE39378	182	29
PE35213	156	69	PE36129	Web		PE37847	187	97	PE38141/BL	Web	113	60	PE39344H	164	71	PE39379	178	35
PE35214	157	87	PE36130	Web		PE37848	187	99	PE38141/GR	Web	113	61	PE39344I	164	72	PE39380	Web	
PE35216	157	88	PE36131	Web		PE37849	187	99	PE38141/RD	Web	113	62	PE39344J	164	73	PE39381	180	27
PE35217	157	88	PE36132	187	47	PE37850	187	99	PE38141/WH	Web	113	63	PE39344K	164	74	PE39382	180	24
PE35218	Web		PE36133	187	46	PE37851	187	99	PE38141/YW	Web	113	64	PE39344L	164	75	PE39383	153	49
PE35220	157	89	PE36134	187	48	PE37852	187	99	PE38142	138	24	PE39344M	164	76	PE39384	163	50	
PE35221	156	77	PE36135	Web		PE37853	187	99	PE38143	138	25	PE39344N	164	77	PE39385	Web		
PE35222	Web		PE36136	187	51	PE37854	187	99	PE38144	132	91	PE39344O	164	78	PE39386	181	13	
PE35223	157	78	PE36137	Web		PE37855	177	3	PE38145	132	92	PE39344P	164	79	PE39387	Web		
PE35224	Web		PE36138	187	52	PE37856	177	3	PE38146	132	93	PE39344Q	164	80	PE39388	180	86	
PE35225	157	79	PE36139	187	52	PE37857	177	3	PE38147	132	94	PE39344R	164	81	PE39389	155	59	
PE35226	157	90	PE36140	187	52	PE37858	177	3	PE38148	132	95	PE39344S	164	82	PE39390	163	59	
PE35227	157	90	PE36141	187	49	PE37859	177	3	PE38149	132	96	PE39344T	164	83	PE39391	163	59	
PE35228	157	80	PE36142	Web		PE37860	177	3	PE38150	132	97	PE39344U	164	84	PE39392	182	27	
PE35229	180	94	PE36143	187	50	PE37861	177	3	PE38151	132	98	PE39344V	164	85	PE39393	182	30	
PE35230	180	96	PE36144	Web		PE37862	177	3	PE38152	132	99	PE39344W	164	86	PE39394	Web		
PE35231	180	99	PE36145	187	40	PE37863	177	3	PE38153	132	100	PE39344X	164	87	PE39395	181	12	
PE35232	Web		PE36146	Web		PE37864	177	3	PE38154	132	101	PE39344Y	164	88	PE39396	Web		
PE35233	180	99	PE36147	187	41	PE37865	177	3	PE38155	132	102	PE39344Z	164	89	PE39397	180	87	
PE35234	Web		PE36148	187	41	PE37866	177	3	PE38156	132	103	PE39344AA	164	90	PE39398	155	44	
PE35235	180	96	PE36149	187	42	PE37867	177	3	PE38157	132	104	PE39344AB	164	91	PE39399	163	59	
PE35236	Web		PE36150	175	51	PE37868	177	3	PE38158	132	105	PE39344AC	164	92	PE39400	163	51	
PE35237	180	97	PE36151	Web		PE37869	177	3	PE38159	132	106	PE39344AD	164	93	PE39401	Web		
PE35238	Web		PE36152	174	48	PE37870	177	3	PE38160	132	107	PE39344AE	164	94	PE39402	Web		
PE35239	Web		PE36153	187	43	PE37871	177	3	PE38161	132	108	PE39344AF	164	95	PE39403	Web		
PE35240	Web		PE36154	Web		PE37872	177	3	PE38162	132	109	PE39344AG	164	96	PE39404	Web		
PE35241	Web		PE36155	Web		PE37873	177	3	PE38163	132	110	PE39344AH	164	97	PE39405	Web		
PE35242	Web		PE36156	Web		PE37874	177	3	PE38164	132	111	PE39344AI	164	98	PE39406	Web		
PE35243	Web		PE36157	Web		PE37875	177	3	PE38165	132	112	PE39344AJ	164	99	PE39407	Web		
PE35244	Web		PE36158	Web		PE37876	177	3	PE38166	132	113	PE39344AK	164	100	PE39408	Web		
PE35245	131	80	PE36159	140	87	PE37877	177	3	PE38167	132	114	PE39344AL	164	101	PE39409	Web		
PE35246	Web		PE36160	175	54	PE37878	177	3	PE38168	132	115	PE39344AM	164	102	PE39410	Web		
PE35247	132	81	PE36161	Web		PE37879	177	3	PE38169	132	116	PE39344AN	164	103	PE39411	Web		
PE35248	180	27	PE36162	175	52	PE37880	177	3	PE38170	132	117	PE39344AO	164	104	PE39412	Web		
PE35249	122	1	PE36163	140	89	PE37881	177	3	PE38171	132	118	PE39344AP	164	105	PE39413	Web		
PE35250	Web		PE36164	Web		PE37882	177	3	PE38172	132	119	PE39344AQ	164	106	PE39414	Web		
PE35251	Web		PE36165	Web		PE37883	177	3	PE38173	132	120	PE39344AR	164	107	PE39415	Web		
PE35252	Web		PE36166	Web		PE37884	177	3	PE38174	132	121	PE39344AS	164	108	PE39416	Web		
PE35253	Web		PE36167	Web		PE37885	177	3	PE38175	132	122	PE39344AT	164	109	PE39417	Web		
PE35254	Web		PE36168	Web		PE37886	177	3	PE38176	132	123	PE39344AU	164	110	PE39418	Web		
PE35255	Web		PE36169	Web		PE37887	177	3	PE38177	132	124	PE39344AV	164	111	PE39419	Web		
PE35256	Web		PE36170	Web		PE37888	177	3	PE38178	132	125	PE39344AW	164	112	PE39420	Web		
PE35257	Web		PE36171	Web		PE37889	177	3	PE38179	132	126	PE39344AX	164	113	PE39421	Web		
PE35258	Web		PE36172	Web		PE37890	177	3	PE38180	132	127	PE39344AY	164	114	PE39422	Web		
PE35259	Web		PE36173	Web		PE37891	177	3	PE38181	132	128	PE39344AZ	164	115	PE39423	Web		
PE35260	Web		PE36174	Web		PE37892	177	3	PE38182	132	129	PE39344BA	164	116	PE39424	Web		
PE35261	Web		PE36175	Web		PE37893	177	3	PE38183	132	130	PE39344BB	164	117	PE39425	Web		
PE35262	Web		PE36176	Web		PE37894	177	3	PE38184	132	131	PE39344BC	164	118	PE39426	Web		
PE35263	Web		PE36177	Web		PE37895	177	3	PE38185	132	132	PE39344BD	164	119	PE39427	Web		
PE35264	Web		PE36178	Web		PE37896	177	3	PE38186	132	133	PE39344BE	164	120	PE39428	Web		
PE35265	Web		PE36179	Web		PE37897	177	3	PE38187	132	134	PE39344BF	164	121	PE39429	Web		
PE35266	Web		PE36180	Web		PE37898	177	3	PE38188	132	135	PE39344BG	164	122	PE39430	Web		
PE35267	Web		PE36181	Web		PE37899	177	3	PE38189	132	136	PE39344BH	164	123	PE39431	Web		
PE35268	Web		PE36182	Web		PE37900	177	3	PE38190	132	137	PE39344BI	164	124	PE39432	Web		
PE35269	Web		PE36183	Web		PE37901	177	3	PE38191	132	138	PE39344BJ	164	125	PE39433	Web		
PE35270	Web		PE36184	Web		PE37902	177	3	PE38192	132	139	PE39344BK	164	126	PE39434	Web		
PE35271	Web		PE36185	Web		PE37903	177	3	PE38193	132	140	PE39344BL	164	127	PE39435	Web		
PE35272	Web		PE36186	Web		PE37904	177	3	PE38194	132	141	PE39344BM	164	128	PE39436	Web		
PE35273	Web		PE36187	Web		PE37905	177	3	PE38195	132	142	PE39344BN	164	129	PE39437	Web		
PE35274	Web		PE36188	Web		PE37906	177	3	PE38196	132	143	PE39344BO	164	130	PE39438	Web		
PE35275	Web		PE36189	Web		PE37907	177	3	PE38197	132	144	PE39344BP	164	131	PE39439	Web		
PE35276	Web		PE36190	Web		PE37908	177	3	PE38198	132	145	PE39344BQ	164	132	PE39440	Web		
PE35277	Web		PE36191	Web		PE37909	177	3	PE38199	132	146	PE39344BR	164	133	PE39441	Web		
PE35278	Web		PE36192	Web		PE37910	177	3	PE38200	132	147	PE39344BS	164	134	PE39442	Web		
PE35279	Web		PE36193	Web		PE37911	177	3	PE38201	132	148	PE39344BT	164	135	PE39443	Web		
PE35280	Web		PE36194	Web		PE37912	177	3	PE38202	132	149	PE39344BU	164	136	PE39444	Web		
PE35281	Web		PE36195	Web		PE37913	177	3	PE38203	132	150	PE39344BV	164	137	PE39445	Web		
PE35282	Web		PE36196	Web		PE37914	177	3	PE38204	132	151	PE39344BW	164	138	PE39446	Web		
PE35283	Web		PE36197	Web		PE37915	177	3	PE38205	132	152	PE39344BX	164	139	PE39447	Web		
PE35284	Web		PE36198	Web		PE37916	177	3	PE38206	132	153	PE39344BY	164	140	PE39448	Web		
PE35285	Web		PE36199	Web		PE37917	177	3	PE38207	132	154	PE39344BZ	164	141	PE39449	Web		
PE35286	Web		PE36200	Web		PE37918	177	3	PE38208	132	155	PE39344CA	164	142	PE39450	Web		
PE35287	Web		PE36201	Web		PE37919	177	3	PE38209	132	156	PE39344CB	164	143	PE39451	Web		
PE35288	Web		PE36202	Web</														

# PART NUMBER INDEX

Note: C/R stands for the Column and/or Row location of the specific product on a given page.

Model No.	Page	C/R	Model No.	Page	C/R	Model No.	Page	C/R	Model No.	Page	C/R	Model No.	Page	C/R	Model No.	Page	C/R	Model No.	Page	C/R
PEC31830	140	90	PEC34012	96	60	PEC34844	102	66	PEC35030	137	3	PEC3A1004	169	12	PEC3M0064	90	66	PEC3M0185	92	85
PEC31875	150	85	PEC34013	96	67	PEC34845	106	62	PEC35233	158	87	PEC3A1005	169	10	PEC3M0065	90	67	PEC3M0186	91	78
PEC31892	154	51	PEC34018	120	35	PEC34846	104	66	PEC35234	144	6	PEC3A1006	169	16	PEC3M0066	90	68	PEC3M0187	92	80
PEC31888	174	34	PEC34018	120	35	PEC34848	104	22	PEC35242	150	7	PEC3A1007	169	8	PEC3M0067	90	72	PEC3M0188	91	79
PEC32000	93	94	PEC34019	119	22	PEC34849	107	85	PEC35244	161	4	PEC3A1008	137	15	PEC3M0068	90	73	PEC3M0189	92	98
PEC3C2001	93	95	PEC34020	120	39	PEC34850	102	80	PEC35246	148	20	PEC3A1009	137	16	PEC3M0069	91	74	PEC3M0190	92	97
PEC3C2002	93	92	PEC34025	119	33	PEC34851	102	77	PEC35247	168	72	PEC3A1010	137	17	PEC3M0070	90	69	PEC3M0191	92	99
PEC3C2003	93	57	PEC34026	120	55	PEC34852	102	72	PEC35248	160	64	PEC3A1011	137	13	PEC3M0071	90	70	PEC3M0192	92	2
PEC3C2004	93	58	PEC34027	119	24	PEC34853	103	85	PEC35249	173	47	PEC3A1012	137	14	PEC3M0072	91	71	PEC3M0193	92	1
PEC3C2005	93	59	PEC34028	120	41	PEC34854	103	99	PEC35250	163	38	PEC3A1013	137	12	PEC3M0073	91	75	PEC3M0194	92	96
PEC3C2006	93	96	PEC34029	119	26	PEC34855	103	71	PEC35251	163	51	PEC3A1014	137	11	PEC3M0074	91	76	PEC3M0195	92	96
PEC3C2007	93	74	PEC34030	120	44	PEC34856	105	38	PEC35252	180	82	PEC3A1016	170	24	PEC3M0075	91	79	PEC3M0196	92	95
PEC3C2008	93	75	PEC34034	119	29	PEC34857	103	6	PEC35253	180	91	PEC3A1017	170	25	PEC3M0076	91	76	PEC3M0197	92	90
PEC3C2009	93	26	PEC34035	120	47	PEC34858	106	75	PEC35254	181	22	PEC3A1018	170	26	PEC3M0077	91	78	PEC3M0198	92	91
PEC3C2010	93	27	PEC34036	119	20	PEC34859	105	44	PEC35255	124	57	PEC3A1019	170	22	PEC3M0078	91	80	PEC3M0199	92	93
PEC3C2011	93	99	PEC34037	120	37	PEC34860	103	93	PEC35256	136	95	PEC3A1020	170	23	PEC3M0079	91	15	PEC3M0200	92	92
PEC3C2012	93	97	PEC34043	120	53	PEC34861	106	68	PEC35257	129	76	PEC3A1021	170	27	PEC3M0080	91	16	PEC3M0201	92	87
PEC3C2013	93	59	PEC34045	120	41	PEC34862	103	110	PEC35258	154	12	PEC3A1022	170	19	PEC3M0081	91	18	PEC3M0202	92	89
PEC3C2014	93	98	PEC34048	119	17	PEC34863	104	16	PEC35259	155	40	PEC3A1023	156	62	PEC3M0082	91	17	PEC3M0203	92	88
PEC3C2015	93	60	PEC34052	120	50	PEC34864	106	82	PEC35260	155	48	PEC3A1024	156	63	PEC3M0083	91	19	PEC3M0204	92	34
PEC3C2034	109	46	PEC34053	120	40	PEC34865	105	54	PEC35261	163	43	PEC3A1025	156	64	PEC3M0084	91	25	PEC3M0205	92	36
PEC3C2035	141	98	PEC34055	120	52	PEC34866	103	11	PEC35262	163	49	PEC3A1026	156	60	PEC3M0085	90	19	PEC3M0206	92	35
PEC3C2162	144	5	PEC34059	120	56	PEC34867	106	77	PEC35263	166	57	PEC3A1027	156	61	PEC3M0086	90	20	PEC3M0207	92	31
PEC3C2180	183	48	PEC34060	119	25	PEC34868	105	49	PEC35264	169	1	PEC3A1028	156	59	PEC3M0087	90	21	PEC3M0208	92	33
PEC3C2220	144	94	PEC34062	119	27	PEC34869	104	69	PEC35265	163	38	PEC3A1029	156	60	PEC3M0088	90	22	PEC3M0209	92	30
PEC3C2276	131	75	PEC34063	120	45	PEC34870	106	79	PEC35266	169	7	PEC3A1030	156	57	PEC3M0089	90	23	PEC3M0210	92	45
PEC3C2295	109	44	PEC34064	119	15	PEC34871	105	51	PEC35267	130	50	PEC3A1031	188	72	PEC3M0090	91	96	PEC3M0211	92	44
PEC3C2305	161	98	PEC34066	119	28	PEC34872	102	70	PEC35268	131	73	PEC3A1032	188	80	PEC3M0091	91	97	PEC3M0212	92	41
PEC3C2306	141	3	PEC34067	120	46	PEC34873	106	65	PEC35269	131	76	PEC3A1033	170	21	PEC3M0092	91	98	PEC3M0213	92	43
PEC3C2404	122	2	PEC34068	119	19	PEC34874	105	60	PEC35270	137	6	PEC3A1035	147	92	PEC3M0093	91	1	PEC3M0214	92	42
PEC3C2416	109	51	PEC34069	120	36	PEC34875	104	26	PEC35271	137	9	PEC3A1036	148	45	PEC3M0094	91	2	PEC3M0215	92	40
PEC3C2425	175	12	PEC34130	93	44	PEC34876	107	87	PEC35272	137	10	PEC3A1037	160	85	PEC3M0095	91	3	PEC3M0216	92	39
PEC3C2426	173	10	PEC34132	93	52	PEC34877	103	83	PEC35273	129	15	PEC3A1038	160	86	PEC3M0096	91	99	PEC3M0217	92	38
PEC3C2599	175	12	PEC34138	93	78	PEC34878	102	78	PEC35274	136	97	PEC3A1039	147	88	PEC3M0097	91	3	PEC3M0218	92	38
PEC3C2884	160	66	PEC34133	93	89	PEC34879	102	76	PEC35275	129	27	PEC3A1040	148	44	PEC3M0098	91	5	PEC3M0219	91	32
PEC3C2892	151	27	PEC34134	93	5	PEC34880	102	87	PEC35276	136	99	PEC3A1041	160	84	PEC3M0099	91	23	PEC3M0220	91	34
PEC3C2953	133	24	PEC34135	93	30	PEC34881	103	4	PEC35277	130	34	PEC3A1042	151	21	PEC3M0100	90	24	PEC3M0221	91	33
PEC3C2985	159	43	PEC34136	93	79	PEC34882	106	73	PEC35278	137	2	PEC3A1043	179	66	PEC3M0101	90	25	PEC3M0222	91	37
PEC3C3028	153	78	PEC34137	93	80	PEC34883	105	42	PEC35279	160	45	PEC3A1044	160	85	PEC3M0102	90	26	PEC3M0223	91	36
PEC3C3115	183	38	PEC34138	93	80	PEC34884	103	10	PEC35280	134	36	PEC3A1046	180	92	PEC3M0103	90	28	PEC3M0224	91	35
PEC3C3159	166	98	PEC34139	93	87	PEC34885	106	76	PEC35281	133	35	PEC3A1047	125	87	PEC3M0104	90	29	PEC3M0225	92	6
PEC3C3205	166	36	PEC34140	93	76	PEC34886	105	48	PEC35282	134	38	PEC3A1048	126	34	PEC3M0105	91	6	PEC3M0226	92	7
PEC3C3221	175	55	PEC34141	93	1	PEC34887	103	97	PEC35283	134	43	PEC3A1049	133	17	PEC3M0106	91	7	PEC3M0227	92	8
PEC3C3233	132	1	PEC34142	93	28	PEC34888	106	69	PEC35284	134	42	PEC3A1050	136	87	PEC3M0107	91	8	PEC3M0228	92	9
PEC3C3234	135	62	PEC34143	93	1	PEC34889	104	36	PEC35285	126	20	PEC3A1052	184	88	PEC3M0108	91	10	PEC3M0229	92	3
PEC3C3235	146	59	PEC34144	93	53	PEC34890	104	20	PEC35286	133	22	PEC3A1053	184	89	PEC3M0109	91	11	PEC3M0230	92	5
PEC3C3236	144	98	PEC34145	93	88	PEC34891	105	88	PEC35287	134	21	PEC3A1054	184	86	PEC3M0110	91	3	PEC3M0231	92	4
PEC3C3237	144	98	PEC34146	93	39	PEC34892	105	58	PEC35288	155	42	PEC3A1055	184	87	PEC3M0111	91	9	PEC3M0232	92	13
PEC3C3238	159	32	PEC34147	93	38	PEC34893	103	12	PEC35289	185	93	PEC3A1056	184	85	PEC3M0112	91	12	PEC3M0233	92	14
PEC3C3240	126	21	PEC34164	154	2	PEC34894	106	78	PEC35290	187	55	PEC3A1057	184	90	PEC3M0113	91	14	PEC3M0234	92	15
PEC3C3241	127	49	PEC34238	136	96	PEC34895	105	50	PEC35291	150	4	PEC3A1058	184	79	PEC3M0114	91	24	PEC3M0235	92	10
PEC3C3242	154	8	PEC34270	195	29	PEC34896	104	14	PEC35833	93	29	PEC3A1102	185	7	PEC3M0115	90	1	PEC3M0236	92	12
PEC3C3243	134	39	PEC34341	174	49	PEC34897	106	80	PEC35834	93	4	PEC3A1103	185	8	PEC3M0116	90	2	PEC3M0237	92	11
PEC3C3244	135	69	PEC34374	176	90	PEC34898	105	52	PEC35835	93	23	PEC3A1104	185	3	PEC3M0117	90	3	PEC3M0238	92	5
PEC3C3245	159	47	PEC34386	103	7	PEC34899	103	65	PEC35836	93	40	PEC3A1105	185	4	PEC3M0118	90	4	PEC3M0239	92	50
PEC3C3246	144	9	PEC34388	176	82	PEC34900	106	61	PEC35837	93	41	PEC3A1106	185	5	PEC3M0119	90	5	PEC3M0240	92	46
PEC3C3248	148	22	PEC34389	176	88	PEC34901	104	21	PEC35838	93	42	PEC3A1107	185	6	PEC3M0120	91	82	PEC3M0241	92	48
PEC3C3249	159	40	PEC34391	153	87	PEC34902	107	84	PEC35839	93	43	PEC3A1130	145	41	PEC3M0121	91	84	PEC3M0242	92	47
PEC3C3252	144	99	PEC34392	164	97	PEC34903	102	79	PEC35840	93	21	PEC3M0001	90	5	PEC3M0122	91	83	PEC3M0243	92	54
PEC3C3255	128	92	PEC34393	166	29	PEC34904	102	71	PEC35841	93	3	PEC3M0002	90	6	PEC3M0123	91	85	PEC3M0244	92	51
PEC3C3275	101	58	PEC34395	168	91	PEC34905	102	64	PEC35842	93	22	PEC3M0003	90	7	PEC3M0124	91	20	PEC3M0245	92	53
PEC3C3286	112	32	PEC34397	168	112	PEC34906	103	98	PEC35843	93	23	PEC3M0004	90	8	PEC3M0125	91	21	PEC3M0246	92	52
PEC3C3314	112	32	PEC34399	130	38	PEC34907	106	70	PEC35844	93	24	PEC3M0005	90	9	PEC3M0126	91	49	PEC3M0247	91	38
PEC3C3318	171	45	PEC34400	130	40	PEC34908	105	37	PEC35845	93	25	PEC3M0006	90	10	PEC3M0127	91	50	PEC3M0248	91	40
PEC3C3321	141	8	PEC34403	176	83	PEC34909	103	5	PEC35846	93	15									

# PART NUMBER INDEX

Note: C/R stands for the Column and/or Row location of the specific product on a given page.

Model No.	Page	C/R	Model No.	Page	C/R	Model No.	Page	C/R	Model No.	Page	C/R	Model No.	Page	C/R	Model No.	Page	C/R	Model No.	Page	C/R
PE3W00135	168	86	PE3W05426	174	44	PE4053	214	98	PE4184	248	4	PE4315	234	61	PE4447	251	4	PE4573	211	80
PE3W00140	122	5	PE3W05453	133	61	PE4054	232	43	PE4188	248	97	PE4316	234	57	PE4448	252	16	PE4574	211	82
PE3W00148	151	46	PE3W05481	132	62	PE4055	215	64	PE4189	238	59	PE4317	233	55	PE4449	252	2	PE4575	211	83
PE3W00169	183	58	PE3W05483	118	12	PE4056	216	46	PE4189	238	61	PE4318	215	42	PE4450	252	37	PE4576	210	57
PE3W00288	186	21	PE3W05498	174	45	PE4057	215	11	PE4190	238	19	PE4319	215	31	PE4451	252	36	PE4576	210	57
PE3W00314	116	42	PE3W05518	177	93	PE4058	215	12	PE4191	229	88	PE4320	214	1	PE4452	252	45	PE4577	235	88
PE3W00322	176	32	PE3W05541	182	43	PE4059	229	14	PE4192	222	36	PE4321	215	16	PE4453	252	46	PE4578	235	81
PE3W00365	146	77	PE3W05557	170	35	PE4060	231	80	PE4193	222	16	PE4322	234	50	PE4454	252	46	PE4579	237	66
PE3W00393	109	50	PE3W05561	183	55	PE4061	229	99	PE4194	234	51	PE4323	222	29	PE4455	252	38	PE4580	236	57
PE3W00415	137	61	PE3W05562	136	1	PE4062	227	12	PE4195	234	68	PE4324	268	13	PE4456	252	33	PE4580	236	57
PE3W00436	152	61	PE3W05585	116	55	PE4063	232	87	PE4196	239	76	PE4325	237	83	PE4457	252	51	PE4581	235	29
PE3W00471	124	77	PE3W05651	131	70	PE4064	254	97	PE4197	239	77	PE4326	237	84	PE4458	252	52	PE4581	235	29
PE3W00430	126	13	PE3W05673	175	56	PE4064SP	254	98	PE4198	221	17	PE4327	236	53	PE4459	252	53	PE4581	237	99
PE3W00504	144	96	PE3W05738	178	33	PE4065	253	88	PE4199	248	5	PE4328	231	81	PE4460	253	61	PE4582	238	15
PE3W00507	144	96	PE3W05740	175	58	PE4066	252	11	PE4200	243	20	PE4329	227	92	PE4461	253	62	PE4583	233	19
PE3W00572	178	41	PE3W05752	182	44	PE4068	253	57	PE4201	244	68	PE4330	229	4	PE4462	252	54	PE4585	243	30
PE3W00597	173	7	PE3W05762	183	54	PE4069	256	63	PE4202	244	69	PE4331	227	18	PE4463	252	63	PE4586	243	30
PE3W00676	172	46	PE3W05845	111	55	PE4070	243	11	PE4203	263	11	PE4332	232	95	PE4464	252	51	PE4587	258	22
PE3W00780	180	88	PE3W05930	170	34	PE4071	251	98	PE4204	215	13	PE4333	234	58	PE4465	253	68	PE4588	258	17
PE3W00790	95	26	PE3W05982	167	65	PE4072	229	1	PE4205	215	14	PE4334	250	56	PE4466	253	69	PE4589	258	23
PE3W00808	179	68	PE3W06017	176	73	PE4073	256	64	PE4206	214	73	PE4335	250	60	PE4467	253	78	PE4600	258	18
PE3W00825	166	35	PE3W06018	176	71	PE4074	244	64	PE4207	214	74	PE4336	250	61	PE4468	253	91	PE4601	258	24
PE3W00832	143	61	PE3W06055	166	27	PE4075	224	88	PE4208	215	23	PE4338	250	63	PE4469	252	92	PE4602	258	6
PE3W00852	159	35	PE3W06085	163	64	PE4076	224	94	PE4209	215	24	PE4339	250	64	PE4470	252	95	PE4603	258	25
PE3W00948	157	34	PE3W06091	132	62	PE4077	215	64	PE4210	214	69	PE4340	250	65	PE4471	252	96	PE4604	258	19
PE3W00921	159	33	PE3W06096	133	19	PE4078	215	29	PE4211	214	89	PE4341	250	66	PE4472	253	40	PE4605	258	32
PE3W00934	167	51	PE3W06305	112	44	PE4079	215	7	PE4212	215	15	PE4342	225	39	PE4473	221	12	PE4607	258	33
PE3W01041	108	31	PE3W06365	123	16	PE4080	243	16	PE4213	235	10	PE4343	234	52	PE4474	221	13	PE4608	258	30
PE3W01114	158	27	PE3W06405	136	98	PE4081	227	13	PE4214	235	94	PE4344	227	93	PE4475	221	18	PE4609	258	34
PE3W01127	126	14	PE3W06410	153	88	PE4082	214	90	PE4215	235	70	PE4345	235	70	PE4476	221	19	PE4610	258	31
PE3W01131	95	33	PE3W06417	130	28	PE4083	237	70	PE4217	239	98	PE4346	268	16	PE4477	221	14	PE4611	258	37
PE3W01263	153	39	PE3W06425	153	23	PE4084	215	71	PE4218	238	62	PE4347	268	18	PE4478	221	20	PE4613	258	38
PE3W01300	108	32	PE3W06444	187	39	PE4088	243	12	PE4219	238	62	PE4348	221	11	PE4479	221	20	PE4615	258	39
PE3W01357	108	32	PE3W06444	187	39	PE4089	266	20	PE4221	227	16	PE4349	234	53	PE4480	221	22	PE4616	258	36
PE3W01379	183	53	PE3W06468	116	53	PE4091	215	41	PE4222	228	30	PE4350	224	90	PE4481	221	26	PE4617	258	58
PE3W01570	116	56	PE3W06649	112	35	PE4092	215	4	PE4223	230	44	PE4351	224	59	PE4482	228	62	PE4618	259	59
PE3W01582	146	49	PE3W06660	159	56	PE4093	224	89	PE4224	227	17	PE4352	221	10	PE4483	228	63	PE4619	259	51
PE3W01626	143	66	PE3W06862	138	31	PE4094	245	81	PE4225	224	7	PE4353	238	51	PE4484	228	64	PE4620	259	52
PE3W01634	116	46	PE3W06701	153	77	PE4095	245	91	PE4226	224	98	PE4354	232	32	PE4485	228	65	PE4621	259	53
PE3W01789	168	28	PE3W06789	181	21	PE4096	286	40	PE4227	224	99	PE4355	231	82	PE4486	228	66	PE4622	259	54
PE3W01959	176	19	PE3W06717	176	72	PE4097	244	47	PE4228	224	24	PE4356	243	22	PE4487	221	84	PE4623	259	57
PE3W01985	162	38	PE3W06829	163	44	PE4098	224	95	PE4229	221	24	PE4358	243	33	PE4488	231	65	PE4624	259	54
PE3W01992	109	67	PE3W06862	111	7	PE4099	239	96	PE4229-401	221	25	PE4359	245	79	PE4489	228	51	PE4625	259	29
PE3W02012	128	99	PE3W06863	126	25	PE4100	234	56	PE4230	221	21	PE4360	243	40	PE4490	228	52	PE4626	259	55
PE3W02209	114	4	PE3W06905	172	84	PE4101	238	60	PE4231	234	43	PE4362	244	53	PE4491	228	56	PE4627	259	28
PE3W02215	131	72	PE3W06981	106	72	PE4104	268	15	PE4232	234	44	PE4364	244	48	PE4492	221	85	PE4628	259	63
PE3W02236	131	72	PE3W06981	106	72	PE4105	268	17	PE4233	234	44	PE4365	243	49	PE4493	221	86	PE4629	259	64
PE3W02356	131	68	PE3W07044	174	46	PE4106	215	22	PE4234	265	6	PE4366	243	24	PE4494	221	97	PE4631	259	61
PE3W02390	163	63	PE3W07068	119	14	PE4107	245	99	PE4235	265	8	PE4367	244	71	PE4495	224	20	PE4632	215	34
PE3W02458	147	84	PE3W07094	136	82	PE4108	236	59	PE4236	265	7	PE4368	263	43	PE4496	234	54	PE4633	258	20
PE3W02466	149	66	PE3W07181	155	41	PE4109	214	72	PE4237	265	9	PE4370	239	82	PE4497	234	55	PE4634	258	21
PE3W02547	127	72	PE3W07265	178	31	PE4110	263	55	PE4238	266	12	PE4371	230	30	PE4498	234	59	PE4635	259	47
PE3W02744	158	26	PE3W07334	167	69	PE4112	235	9	PE4239	234	64	PE4372	229	5	PE4499	234	65	PE4637	259	48
PE3W02882	158	9	PE3W07386	117	62	PE4113	230	42	PE4240	214	64	PE4374	218	35	PE4500	234	66	PE4638	259	46
PE3W02943	114	9	PE3W07411	187	38	PE4114	234	44	PE4241	214	40	PE4375	218	36	PE4501	234	67	PE4639	259	49
PE3W02985	168	85	PE3W07481	93	7	PE4115	237	8	PE4242	218	9	PE4376	228	31	PE4502	262	23	PE4640	259	44
PE3W02976	135	64	PE3W07489	93	91	PE4116	237	9	PE4243	218	10	PE4377	214	75	PE4503	262	29	PE4641	259	45
PE3W02993	148	32	PE3W07491	95	40	PE4117	238	21	PE4244	218	21	PE4378	214	60	PE4504	262	22	PE4642	259	46
PE3W02994	161	99	PE3W07532	119	31	PE4118	240	17	PE4245	243	34	PE4379	214	76	PE4505	262	27	PE4643	214	66
PE3W03014	152	64	PE3W07591	118	9	PE4119	238	49	PE4246	245	80	PE4380	214	67	PE4506	262	28	PE4644	225	50
PE3W03030	152	62	PE3W07602	188	64	PE4120	238	49	PE4247	214	58	PE4381	214	67	PE4507	262	17	PE4645	222	12
PE3W03036	164	49	PE3W07641	187	38	PE4121	238	49	PE4248	238	69	PE4382	214	62	PE4508	262	13	PE4646	222	13
PE3W03078	139	61	PE3W07647	182	25	PE4123	240	25	PE4249	264	68	PE4383	214	78	PE4509	262	18	PE4647	227	4
PE3W03154	120	43	PE3W07649	181	11	PE4125	236	35	PE4250	243	21	PE4384	214	79	PE4510	262	14	PE4648	262	26
PE3W03175	182	39	PE3W07653	118	10	PE4126	236	39	PE4251	263	46	PE4386	214	80	PE4511	262	19	PE4649	262	27
PE3W03271	100																			

# PART NUMBER INDEX

Note: C/R stands for the Column and/or Row location of the specific product on a given page.

Model No.	Page	C/R	Model No.	Page	C/R	Model No.	Page	C/R	Model No.	Page	C/R	Model No.	Page	C/R	Model No.	Page	C/R	Model No.	Page	C/R
PE4708	253	24	PE4883	222	56	PE44042	214	82	PE44192	242	4	PE44356	211	90	PE44510	233	20	PE44649K	219	66
PE4709	224	1	PE4884	223	61	PE44045	227	19	PE44193	242	5	PE44357	212	3	PE44511	233	27	PE44649Z	219	67
PE4710	216	62	PE4885	223	70	PE44046	227	27	PE44194	242	6	PE44358	212	4	PE44512	233	21	PE44650A	220	93
PE4711	216	62	PE4886	223	70	PE44047	245	93	PE44195	242	10	PE44359	211	97	PE44513	232	28	PE44650B	220	94
PE4712	216	56	PE4887	223	71	PE44048	244	49	PE44196	242	11	PE44360	212	5	PE44514	232	6	PE44650C	220	95
PE4713	216	57	PE4888	223	72	PE44049	234	62	PE44197	242	12	PE44361	211	92	PE44515	232	13	PE44650D	220	96
PE4714	216	63	PE4889	223	67	PE44050	256	69	PE44198	242	6	PE44362	211	93	PE44520	227	90	PE44650H	220	97
PE4715	216	58	PE4890	223	78	PE44051	256	66	PE44199	242	14	PE44363	211	95	PE44521	227	98	PE44650I	220	98
PE4716	216	59	PE4891	223	74	PE44052	256	70	PE44200	242	13	PE44364	211	96	PE44522	227	99	PE44650J	220	99
PE4717	216	64	PE4892	223	69	PE44053	256	67	PE44201	242	7	PE44365	211	98	PE44523	227	1	PE44650K	220	100
PE4718	216	60	PE4893	223	69	PE44054	256	68	PE44202	242	6	PE44366	211	99	PE44524	228	57	PE44650L	220	101
PE4719	216	65	PE4894	223	75	PE44055	256	75	PE44203	236	74	PE44367	211	1	PE44525	228	58	PE44651B	220	69
PE4720	216	61	PE4896	226	54	PE44056	256	76	PE44204	238	22	PE44368	211	2	PE44526	228	59	PE44651C	220	70
PE4721	216	66	PE4897	226	55	PE44057	256	73	PE44205	238	23	PE44369	223	80	PE44527	228	60	PE44651D	220	71
PE4722	216	67	PE4898	226	61	PE44058	256	74	PE44206	238	24	PE44370	223	81	PE44528	230	33	PE44651E	220	72
PE4726	216	68	PE4899	226	62	PE44059	256	77	PE44207	238	25	PE44373	223	84	PE44529	230	34	PE44651F	220	73
PE4727	217	73	PE4901	226	66	PE44060	256	79	PE44208	238	26	PE44374	223	85	PE44530	230	35	PE44651G	220	74
PE4728	217	74	PE4902	226	67	PE44061	256	81	PE44209	238	27	PE44375	224	87	PE44531	230	36	PE44651H	220	75
PE4729	216	70	PE4903	226	72	PE44062	251	1	PE44211	238	63	PE44377	223	86	PE44532	229	92	PE44652	259	56
PE4730	216	71	PE4904	226	71	PE44065	231	70	PE44212	238	64	PE44378	248	13	PE44533	229	93	PE44653	259	57
PE4731	217	75	PE4905	226	59	PE44066	231	71	PE44213	238	65	PE44379	248	1	PE44534	229	94	PE44654	252	34
PE4732	217	76	PE4906	264	84	PE44068	231	72	PE44214	238	66	PE44380	248	14	PE44535	229	95	PE44655	247	81
PE4733	216	72	PE4907	235	17	PE44069	231	73	PE44215	206	38	PE44381	248	2	PE44536	209	17	PE44656	211	75
PE4735	217	82	PE4908	214	86	PE44070	231	76	PE44216	206	44	PE44382	248	9	PE44537	210	38	PE44657	215	27
PE4736	217	83	PE4909	246	28	PE44071	231	77	PE44217	207	54	PE44383	248	11	PE44538	210	39	PE44658	215	28
PE4737	217	78	PE4910	238	32	PE44072	231	78	PE44220	206	41	PE44384	248	16	PE44542	210	42	PE44660	223	64
PE4738	217	79	PE4911	240	18	PE44073	231	79	PE44227	207	72	PE44385	248	22	PE44543	210	43	PE44661	223	65
PE4739	217	80	PE4912	236	29	PE44074	231	89	PE44229	207	83	PE44386	248	23	PE44544	210	55	PE44662	226	70
PE4740	217	84	PE4913	236	30	PE44075	231	90	PE44232	207	69	PE44387	249	25	PE44545	210	70	PE44663	226	58
PE4741	217	85	PE4914	238	43	PE44076	231	91	PE44235	238	27	PE44388	249	31	PE44546	210	56	PE44664	240	28
PE4742	217	81	PE4915	215	35	PE44077	231	68	PE44236	240	26	PE44389	249	32	PE44548	210	71	PE44665	241	55
PE4743	217	86	PE4916	231	68	PE44078	231	69	PE44237	240	27	PE44390	249	34	PE44549	210	72	PE44666	241	56
PE4744	217	87	PE4917	235	18	PE44080	234	63	PE44238	240	22	PE44391	249	30	PE44550	211	73	PE44667	235	78
PE4745	217	88	PE4918	235	19	PE44083	225	43	PE44239	240	23	PE44392	249	40	PE44551	211	74	PE44669	237	90
PE4746	217	92	PE4919	237	77	PE44084	225	44	PE44240	240	15	PE44393	249	41	PE44554	229	84	PE44670	254	5
PE4747	217	89	PE4920	237	78	PE44085	225	45	PE44241	240	16	PE44394	249	50	PE44555	229	9	PE44671	255	32
PE4748	217	90	PE4921	238	16	PE44086	225	46	PE44242	205	1	PE44395	249	46	PE44558	209	25	PE44672	254	6
PE4749	217	93	PE4922	238	17	PE44087	225	47	PE44243	205	2	PE44396	230	23	PE44560	210	63	PE44673	255	33
PE4750	217	91	PE4923	238	57	PE44088	225	48	PE44244	205	3	PE44397	231	63	PE44561	210	64	PE44674	215	18
PE4751	217	91	PE4924	238	58	PE44089	225	48	PE44247	205	6	PE44398	249	12	PE44565	229	10	PE44675	229	61
PE4752	217	95	PE4925	243	37	PE44090	225	41	PE44248	205	6	PE44401	248	17	PE44568	209	26	PE44676	258	14
PE4756	217	1	PE4927	245	83	PE44091	225	51	PE44249	205	7	PE44402	248	18	PE44569	210	49	PE44677	259	42
PE4757	217	96	PE4928	263	54	PE44092	225	49	PE44254	205	10	PE44403	249	26	PE44572	259	72	PE44678	258	35
PE4758	217	97	PE4930	238	18	PE44093	Web		PE44255	205	11	PE44404	249	27	PE44573	259	73	PE44679	235	13
PE4759	217	3	PE4931	238	59	PE44094	244	50	PE44256	205	12	PE44405	249	35	PE44574	262	34	PE44680	236	25
PE4760	217	4	PE4932	237	79	PE44095	245	94	PE44257	205	9	PE44406	249	36	PE44576	262	35	PE44682	237	73
PE4761	217	69	PE4933	238	28	PE44096	244	16	PE44258	205	10	PE44407	249	37	PE44577	262	36	PE44683	237	74
PE4763	217	2	PE4934	238	36	PE44098	218	27	PE44259	205	13	PE44408	248	15	PE44578	258	27	PE44684	237	12
PE4764	217	98	PE4935	229	74	PE44099	218	28	PE44260	205	15	PE44419	248	19	PE44579	260	79	PE44685	238	13
PE4765	217	99	PE4936	229	79	PE44100	224	3	PE44261	205	16	PE44420	248	20	PE44580	262	36	PE44686	238	14
PE4766	240	35	PE4937	229	80	PE44102	224	4	PE44262	257	96	PE44421	248	21	PE44582	259	70	PE44687	238	55
PE4767	240	31	PE4938	229	75	PE44103	224	5	PE44263	257	97	PE44422	248	24	PE44583	262	30	PE44689	222	57
PE4768	240	39	PE4940	230	39	PE44104	224	8	PE44264	257	98	PE44423	249	28	PE44584	258	7	PE44693	226	63
PE4769	240	32	PE4941	230	40	PE44105	224	12	PE44265	257	99	PE44425	249	28	PE44585	260	83	PE44702	228	32
PE4770	240	36	PE4942	230	41	PE44106	224	13	PE44266	257	100	PE44426	249	33	PE44586	260	84	PE44703	229	33
PE4771	240	33	PE4943	230	54	PE44107	224	9	PE44267	257	2	PE44427	249	37	PE44587	259	41	PE44702	229	76
PE4772	240	40	PE4945	229	20	PE44108	224	10	PE44268	257	5	PE44428	249	38	PE44588	261	99	PE44703	229	77
PE4773	240	37	PE4946	230	59	PE44109	224	14	PE44270	257	3	PE44429	249	39	PE44590	261	5	PE44704	229	15
PE4774	Web		PE4949	218	17	PE44110	224	11	PE44271	257	4	PE44430	248	10	PE44591	261	6	PE44705	229	16
PE4775	240	41	PE4950	218	11	PE44111	224	15	PE44274	248	91	PE44431	248	11	PE44593	240	24	PE44706	230	55
PE4777	240	42	PE4951	218	13	PE44112	224	23	PE44275	248	92	PE44432	248	12	PE44594	256	83	PE44707	230	56
PE4778	241	48	PE4952	218	14	PE44113	224	11	PE44276	248	93	PE44433	248	13	PE44595	256	84	PE44708	230	57
PE4780	241	48	PE4953	218	14	PE44115	265	10	PE44277	209	23	PE44434	249	51	PE44599	233	33	PE44709	252	25
PE4782	241	51	PE4954	218	15	PE44116	266	14	PE44278	209	24	PE44435	249	52	PE44600	233	34	PE44710	252	49
PE4784	241	49	PE4955	218	18	PE44117	Web		PE44280	210	45	PE44436	249	44	PE44601	233	35	PE44711	252	50
PE4785	240	45	PE4957	218	22	PE44118	234	60	PE44282	210</										

# PART NUMBER INDEX

Note: C/R stands for the Column and/or Row location of the specific product on a given page.

Model No.	Page	C/R	Model No.	Page	C/R	Model No.	Page	C/R	Model No.	Page	C/R	Model No.	Page	C/R	Model No.	Page	C/R			
PE44825	228	25	PE45011	208	87	PE45287	247	86	PE45445	252	48	PE45049	57	12	PE51MP1011	62	83	PE55C3032	Web	
PE44826	235	1	PE45012	240	43	PE45290	247	89	PE45446	226	26	PE51050	58	19	PE51OM1001	62	4	PE55C3033	Web	
PE44827	238	29	PE45032	211	91	PE45292	238	42	PE45447	230	52	PE51052	58	20	PE51OM1002	63	8	PE55C3034	Web	
PE44828	256	72	PE45035	224	25	PE45295	202	97	PE45448	229	73	PE51054	57	2	PE51OM1003	63	9	PE55C3035	Web	
PE44830	223	58	PE45036	230	27	PE45296	208	98	PE45450	207	70	PE51055	61	32	PE51OM1004	62	5	PE55C3038	Web	
PE44840	246	27	PE45037	209	28	PE45297	209	99	PE45490BK	Web		PE51056	61	31	PE51OM1005	62	6	PE55C3039	Web	
PE44842	250	62	PE45039	239	84	PE45298	209	1	PE45404Z	Web		PE51057	59	61	PE51OM1006	63	10	PE55TL1000	313	
PE44843	214	97	PE45040	235	79	PE45299	209	2	PE45451	207	71	PE51058	59	63	PE51OM1007	62	99	PE55TR1000	Web	
PE44844	229	65	PE45041	236	63	PE45300	209	3	PE45452	207	55	PE51059	59	62	PE51OM1008	62	98	PE55TR1001	Web	
PE44845	Web		PE45042	235	2	PE45301	209	4	PE45453	207	56	PE51060	60	88	PE51OM1009	62	98	PE55TR1002	Web	
PE44846	252	40	PE45045	213	54	PE45302	209	9	PE45454	206	42	PE51061	59	69	PE51OM1010	62	2	PE55TR1003	Web	
PE44847	254	1	PE45046	210	44	PE45303	209	10	PE45455	206	43	PE51062	59	66	PE51OM1011	62	3	PE55TR1004	Web	
PE44848	245	4	PE45047	230	38	PE45304	209	15	PE45456	206	33	PE51063	59	67	PE51OM1012	62	7	PE55TR1005	Web	
PE44849	246	28	PE45048	237	64	PE45306	209	16	PE45457	206	34	PE51064	59	71	PE51OM1013	62	88	PE55TR1006	Web	
PE44852	226	65	PE45050	223	62	PE45307	221	23	PE45458	237	92	PE51065	59	74	PE51OM1014	62	89	PE55TR1007	Web	
PE44872	283	51	PE45051	223	63	PE45310	212	13	PE45459	237	93	PE51066	60	81	PE51OM1015	62	90	PE55TR1008	Web	
PE44874	243	93	PE45053	239	12	PE45311	212	14	PE45460	237	98	PE51067	60	78	PE51OM1016	62	91	PE55TR1009	Web	
PE44875	244	62	PE45054	Web		PE45313	212	15	PE45461	235	91	PE51068	60	80	PE51OM1017	62	93	PE55TR1010	Web	
PE44876	245	74	PE45055	239	88	PE45314	212	16	PE45462	237	1	PE51070	61	59	PE51OM1018	62	94	PE55TR1011	Web	
PE44877	230	37	PE45064	215	21	PE45315	212	9	PE45463	237	2	PE51072	61	54	PE51OM1019	62	92	PE55TR1012	Web	
PE44879	246	15	PE45066	251	6	PE45316	212	10	PE45464	237	3	PE51076	61	46	PE51OM1020	62	86	PE55TR1013	Web	
PE44880	246	16	PE45067	239	85	PE45317	212	11	PE45465	237	4	PE51077	61	45	PE51OM1021	62	87	PE55TR1014	Web	
PE44886	215	33	PE45071	233	31	PE45318	212	12	PE45466	237	5	PE51078	61	50	PE51OM1022	60	1	PE55TR1015	Web	
PE44887	215	47	PE45072	232	86	PE45319	212	13	PE45467	237	6	PE51080	61	52	PE51OM1023	62	7	PE55TR1016	Web	
PE44888	216	48	PE45086	261	95	PE45320	212	33	PE45468	207	76	PE51081	61	53	PE51OM1024	62	97	PE55TR1019	Web	
PE44890	216	44	PE45114	213	55	PE45321	213	41	PE45469	207	77	PE51082	61	51	PE51OM1025	62	95	PE55TR1020	Web	
PE44891	216	45	PE45116	258	15	PE45322	213	44	PE45470	207	78	PE51083	61	52	PE51OM1026	62	96	PE6002	307	10
PE44892	254	3	PE45117	258	16	PE45323	213	40	PE45471	207	79	PE51084	61	55	PE51PD1001	58	42	PE6006	267	49
PE44893	256	62	PE45119	243	23	PE45324	212	34	PE45472	206	46	PE51085	61	56	PE51PD1002	58	40	PE6007	267	52
PE44894	253	93	PE45126	246	46	PE45325	212	35	PE45473	206	47	PE51087	61	48	PE51PD1003	58	41	PE6009	308	73
PE44895	243	49	PE45128	248	50	PE45326	212	36	PE45474	206	48	PE51088	61	49	PE51PD1004	58	33	PE6012	267	34
PE44896	242	19	PE45128	248	90	PE45327	213	43	PE45475	206	49	PE51089	61	27	PE51PD1005	58	38	PE6013	267	3
PE44897	253	80	PE45130	253	94	PE45328	213	36	PE45476	206	50	PE51090	61	42	PE51PD1006	58	39	PE6014	267	4
PE44898	253	86	PE45131	215	28	PE45329	213	49	PE45477	206	29	PE51096	59	64	PE51RD1002	62	68	PE6015	267	5
PE44899	253	70	PE45132	253	95	PE45330	213	50	PE45478	256	79	PE51098	59	57	PE51RD1003	62	70	PE6016	267	16
PE44900	253	71	PE45133	231	74	PE45331	213	51	PE45479	234	46	PE51113	60	93	PE51RD1004	62	69	PE6017	267	17
PE44901	253	96	PE45134	239	68	PE45332	213	48	PE45480	236	27	PE51117A	61	36	PE51RD1005	62	72	PE6018	267	18
PE44902	253	46	PE45135	239	15	PE45333	212	30	PE45481	236	28	PE51118	61	34	PE51RD1006	62	71	PE6019	267	22
PE44903	253	47	PE45136	238	39	PE45334	212	46	PE45482	237	25	PE51119	61	35	PE51RD1007	62	73	PE6020	267	23
PE44906	247	57	PE45137	237	91	PE45335	212	7	PE45483	207	63	PE51121	61	38	PE51SE1001	59	51	PE6021	267	35
PE44907	246	48	PE45138	238	40	PE45336	212	8	PE45484	206	26	PE51122	61	39	PE51SE1002	59	52	PE6022	267	45
PE44908	248	93	PE45139	236	37	PE45337	213	37	PE45485	207	64	PE51123	61	40	PE51SE1003	59	48	PE6023	267	33
PE44909	247	59	PE45140	235	3	PE45338	213	38	PE45486	207	65	PE51124	61	41	PE51SE1004	59	46	PE6024	267	23
PE44910	246	29	PE45141	238	41	PE45339	212	25	PE45487	207	66	PE51125A	61	60	PE51SE1005	59	47	PE6026	310	2
PE44911	246	94	PE45142	235	4	PE45340	213	45	PE45488	250	68	PE51126	61	61	PE51SE1006	59	45	PE6030	267	43
PE44912	247	80	PE45143	235	56	PE45341	212	47	PE45489	250	69	PE51127	61	62	PE51SE1007	59	46	PE6031	267	44
PE44913	248	95	PE45145	235	80	PE45342	212	18	PE45492	250	70	PE51128	61	63	PE51SE1008	59	54	PE6032	308	76
PE44914	248	96	PE45147	245	3	PE45343	212	19	PE45493	250	80	PE51129	58	21	PE51SE1009	59	50	PE6033	310	1
PE44915	248	97	PE45150	215	19	PE45344	212	20	PE45494	250	81	PE51133	61	44	PE51TM1000	60	79	PE6034	308	11
PE44916	246	49	PE45153	249	55	PE45345	212	22	PE45496	250	73	PE51134	61	58	PE51TM1001	63	20	PE6035	308	14
PE44917	247	84	PE45155	244	65	PE45346	212	23	PE45497	250	74	PE51135A	61	57	PE51TW1000	60	5	PE6036	308	16
PE44918	247	67	PE45156	245	62	PE45347	212	21	PE45498	250	75	PE51136	60	4	PE51VA1001	58	32	PE6037	309	31
PE44919	247	69	PE45157	245	95	PE45348	212	64	PE45499	250	76	PE51137	61	64	PE51VA1002	59	33	PE6038	309	34
PE44920	247	68	PE45158	243	36	PE45349	213	39	PE45500	260	84	PE51143	61	65	PE51VA1003	58	34	PE6039	309	59
PE44921	247	69	PE45159	244	51	PE45350	212	26	PE45507	207	80	PE51144	61	66	PE51VA1004	58	31	PE6040	309	60
PE44922	247	70	PE45161	251	97	PE45351	212	27	PE45508	207	81	PE51145	60	6	PE51VA1005	58	35	PE6041	309	75
PE44923	247	71	PE45162	250	57	PE45352	212	28	PE45509	207	59	PE51146	60	7	PE51VA1006	58	36	PE6043	309	82
PE44924	247	72	PE45164	266	19	PE45353	212	29	PE45510	207	60	PE51147	61	14	PE51VA1007	58	22	PE6046	267	1
PE44925	247	73	PE45165	242	96	PE45354	213	47	PE45511	206	51	PE51148	60	10	PE51VA1008	58	23	PE6057	267	7
PE44926	247	74	PE45166	205	4	PE45355	212	31	PE45512	206	52	PE51149	61	11	PE51VA1009	58	24	PE6058	267	2
PE44927	247	75	PE45168	222	40	PE45356	212	72	PE45513	206	36	PE51150	61	18	PE51VA1010	58	25	PE6059	267	12
PE44928	247	76	PE45169	222	40	PE45356	250	71	PE45514	206	37	PE51151	61	20	PE51VA1011	58	26	PE6069	307	33
PE44930	247	77	PE45170	211	86	PE45356	250	72	PE45515	206	30	PE51152	61	17	PE51VA1012	58	28	PE6070	307	11
PE44931	247	61	PE45171	211	94	PE45370	251	82	PE45516	206	31	PE51153	61	15	PE51VA1013	58	29	PE6071	307	35
PE44932	247	65	PE45172	229	97	PE45371	251	83	PE45517	206	20	PE51154	61	19	PE51VA1014	58	30	PE6072	307	34
PE44933	247	78	PE45173	230	51	PE45375	251	84	PE45518	206	21	PE51155	61							



# PART NUMBER INDEX

Note: C/R stands for the Column and/or Row location of the specific product on a given page.

Model No.	Page	C/R	Model No.	Page	C/R	Model No.	Page	C/R	Model No.	Page	C/R	Model No.	Page	C/R	Model No.	Page	C/R
PE6133	267	53	PE6826	347	83	PE7050-1	79	37	PE70A1001	80	44	PE71S6166	289	43	PE71S6287	288	94
PE6134	Web		PE6828	346	49	PE7051-1	71	36	PE70A1008	80	45	PE71S6167	289	45	PE71S6288	288	96
PE6135	267	55	PE6829	346	55	PE7052-1	71	44	PE70A1009	68	20	PE71S6168	289	39	PE71S6289	288	97
PE6136	267	54	PE6830	347	60	PE7053-1	72	54	PE70A1010	68	21	PE71S6169	289	41	PE71S6290	288	98
PE6137	309	71	PE6831	347	65	PE7054-1	73	74	PE70A1011	68	22	PE71S6170	289	51	PE71S6291	288	99
PE6138	308	8	PE6832	347	70	PE7055-10	75	99	PE70A1012	68	23	PE71S6171	289	53	PE71S6292	288	95
PE6139	308	99	PE6833	347	76	PE7056-30	78	24	PE70A1013	68	24	PE71S6172	289	47	PE71S6293	288	62
PE6140	308	19	PE6834	347	79	PE7057-1	79	38	PE70A1014	68	25	PE71S6173	289	49	PE71S6294	288	63
PE6141	309	10	PE6835	347	84	PE7058-1	81	52	PE70A1015	68	26	PE71S6174	289	44	PE71S6295	288	64
PE6143	267	36	PE6836	347	64	PE7062-6	81	52	PE70A1016	68	27	PE71S6175	289	46	PE71S6296	288	65
PE6144	267	34	PE68R000	310	99	PE7063-6	81	52	PE70A1017	68	28	PE71S6176	289	40	PE71S6297	288	68
PE6146	307	7	PE68R001	310	3	PE7064-6	81	55	PE70A1021	79	42	PE71S6177	289	42	PE71S6298	288	69
PE6150	307	29	PE68R002	307	42	PE7066	311	7	PE70A1022	80	48	PE71S6178	289	52	PE71S6299	288	66
PE6151	307	32	PE68R003	310	98	PE7067	311	6	PE70A1023	80	50	PE71S6179	289	54	PE71S6300	288	67
PE6154	308	66	PE68R004	310	97	PE7068	311	8	PE70A1024	80	47	PE71S6180	289	48	PE71S6301	288	81
PE6156	308	65	PE68R005	307	44	PE7069	311	9	PE70A1025	80	49	PE71S6181	289	50	PE71S6302	288	74
PE6159	307	48	PE68R006	308	43	PE7070	311	14	PE70A1031	82	84	PE71S6182	Web		PE71S6303	288	77
PE6161	307	46	PE68R007	307	63	PE7071	311	12	PE70A2000	82	87	PE71S6183	288	12	PE71S6304	288	78
PE6162	307	9	PE68R008	308	64	PE7072	311	10	PE70A2001	82	88	PE71S6184	288	7	PE71S6305	288	72
PE6163	307	8	PE68R009	308	70	PE7073	311	15	PE70A2002	82	89	PE71S6185	288	9	PE71S6306	288	73
PE6165	310	96	PE68R010	308	67	PE7074	311	17	PE70A2003	82	90	PE71S6186	288	18	PE71S6307	288	70
PE6168	309	77	PE68R011	308	74	PE7075	311	21	PE70A2900	82	86	PE71S6187	288	20	PE71S6308	288	71
PE6169	307	17	PE68R012	308	81	PE7076	311	23	PE70A2900	82	87	PE71S6188	288	14	PE71S6309	288	92
PE6170	307	88	PE68R013	308	89	PE7077	311	25	PE70A3015	82	20	PE71S6189	288	15	PE71S6310	288	93
PE6173	307	19	PE68R014	308	87	PE7078	311	27	PE70A3015	82	80	PE71S6190	288	11	PE71S6311	288	88
PE6174	307	18	PE68R015	308	94	PE7079	311	28	PE70A4000	82	64	PE71S6191	288	13	PE71S6312	288	89
PE6176	307	20	PE68R016	308	90	PE7081	311	29	PE70A5000	82	70	PE71S6192	288	8	PE71S6313	288	84
PE6176	307	54	PE68R028	308	97	PE7082	311	30	PE70A5001	82	71	PE71S6193	288	10	PE71S6314	288	85
PE6177	307	53	PE68R029	309	49	PE7083	311	19	PE70A5002	82	72	PE71S6194	288	19	PE71S6315	288	82
PE6178	307	17	PE68R030	309	37	PE7084-30	78	32	PE70A5003	81	57	PE71S6195	288	21	PE71S6316	288	83
PE6178	307	44	PE68R031	309	58	PE7085	311	63	PE70A5004	81	58	PE71S6196	288	22	PE71S6317	288	86
PE6180	307	52	PE68R032	309	83	PE7087-0	69	34	PE70A5005	82	68	PE71S6197	288	17	PE71S6318	288	87
PE6181	307	13	PE68R033	310	87	PE7088-0	66	6	PE70A5006	82	67	PE71S6198	288	5	PE71S6319	288	21
PE6182	307	2	PE68R034	310	90	PE7089-10	66	5	PE70A5007	82	69	PE71S6199	288	6	PE71S6320	288	22
PE6183	307	12	PE68R035	310	91	PE7090-3	67	15	PE70A5008	82	78	PE71S6200	288	3	PE71S6321	288	33
PE6184	307	1	PE68R036	310	92	PE7091-0	68	29	PE70A5009	82	73	PE71S6201	288	4	PE71S6322	288	34
PE6185	308	13	PE68R037	307	61	PE7092-1	69	33	PE70A5010	82	75	PE71S6202	288	57	PE71S6323	288	37
PE6186	308	2	PE68R038	307	23	PE7100	294	67	PE70A5011	82	76	PE71S6203	288	63	PE71S6324	288	38
PE6187	308	1	PE68R039	308	23	PE7101	294	68	PE70A5012	82	65	PE71S6204	288	65	PE71S6325	288	39
PE6188	308	48	PE68R040	308	22	PE7103	294	69	PE70A5013	82	74	PE71S6205	288	67	PE71S6326	288	40
PE6189	309	47	PE68R041	308	20	PE7120D	297	54	PE70A5014	82	77	PE71S6206	288	2	PE71S6327	288	45
PE6190	307	60	PE68R042	308	21	PE7139	295	74	PE70A6001	82	79	PE71S6207	288	1	PE71S6328	288	46
PE6191	309	43	PE68R043	309	41	PE7139-CART	287	92	PE70A8000	81	59	PE71S6208	288	7	PE71S6329	288	47
PE6193	267	39	PE68R044	309	40	PE7140	295	75	PE70A8001	81	58	PE71S6209	288	8	PE71S6330	288	48
PE6194	267	37	PE68R045	309	38	PE7152	298	61	PE70A8002	81	63	PE71S6210	288	11	PE71S6331	288	49
PE6195	308	19	PE68R046	309	39	Web	Web		PE70A8003	81	64	PE71S6211	288	12	PE71S6332	288	50
PE6196	308	62	PE68R047	309	65	PE7160	Web		PE70A8004	81	61	PE71S6212	288	13	PE71S6333	288	51
PE6197	309	69	PE68R048	309	64	PE7161-1	67	11	PE70A8005	81	62	PE71S6213	288	14	PE71S6334	288	52
PE6198	309	51	PE68R049	309	63	PE7162-1	69	30	PE70A9000	82	91	PE71S6214	288	15	PE71S6335	288	53
PE6199	307	25	PE68R050	Web		PE7201-3	76	5	PE70A9001	82	92	PE71S6215	288	16	PE71S6336	288	54
PE6200	346	44	PE68R051	309	76	PE7202-3	77	16	PE70A9002	82	93	PE71S6216	288	17	PE71S6337	288	55
PE6201	Web		PE68R052	309	79	PE7203-3	75	3	PE70A9003	82	94	PE71S6217	288	18	PE71S6338	288	56
PE6201A	61		PE68R053	309	84	PE7204-3	75	9	PE70A9004	82	95	PE71S6218	288	19	PE71S6339	288	57
PE6202	310	95	PE68R054	309	72	PE7205-3	76	10	PE70A9005	82	96	PE71S6219	288	20	PE71S6340	288	58
PE6202-100PK	310	93	PE68R055A	309	66	PE7206-3	77	17	PE70A9006	82	97	PE71S6220	288	21	PE71S6341	288	59
PE6202-25PK	310	94	PE68R056	309	67	PE7207-3	76	7	PE70A9007	82	98	PE71S6221	288	22	PE71S6342	288	60
PE6203	309	32	PE68R057	308	78	PE7208-3	77	18	PE70A9008	82	99	PE71S6222	288	23	PE71S6343	288	61
PE6204	309	33	PE68R058	307	41	PE7210-30	78	25	PE70A9009	83	1	PE71S6223	288	24	PE71S6344	288	62
PE6205	309	28	PE68R059	307	28	PE7211-3	75	4	PE70A9010	83	2	PE71S6224	288	25	PE71S6345	288	63
PE6206	309	30	PE68R060	307	29	PE7212-3	76	8	PE70A9011	83	3	PE71S6225	288	26	PE71S6346	288	64
PE6207	309	35	PE68R061	307	47	PE7213-3	76	9	PE70A9012	83	4	PE71S6226	288	27	PE71S6347	288	65
PE6208	309	36	PE68R062	307	21	PE7214-3	77	14	PE70A9013	83	5	PE71S6227	288	28	PE71S6348	288	66
PE6209	308	25	PE68R063	307	22	PE7216-50	Web		PE70A9014	83	6	PE71S6228	288	29	PE71S6349	288	67
PE6210	309	26	PE68R064	307	23	PE7218-3	78	26	PE70A9015	83	7	PE71S6229	288	30	PE71S6350	288	68
PE6211	309	56	PE68R065	307	24	PE7221-3	77	22	PE70A9016	83	8	PE71S6230	288	31	PE71S6351	288	69
PE6212	309	59	PE68R066	307	55	PE7224-03	Web		PE70A9017	83	9	PE71S6231	288	32	PE71S6352	288	70
PE6213	309	50	PE68R067	307	56	PE7225-10	Web		PE70A9018	83	10	PE71S6232	288	33	PE71S6353	288	71
PE6214	309	54	PE68R068	307	57	PE7226-10	Web		PE70A9019	83	11	PE71S6233	288	34	PE71S6354	288	72
PE6215	309	61	PE68R069	307	58	PE7227-50	Web		PE70A9020	83	12	PE71S6234	288	35	PE71S6355	288	73
PE6216	309	62	PE68R070	307	59	PE7228-3	78	23	PE70MP1002	311	11	PE71S6235	288	36	PE71S6356	288	74
PE6217	309	45	PE68R071	307	26	PE7237-30	77	15	PE70MP1004	311	26	PE71S6236	288	37	PE71S6357	288	75
PE6218	309	46	PE68R072	307	27	PE7301-1	287	48	PE70MP1005	311	24	PE71S6237	288	38	PE71S6358	288	76
PE6219	309	81	PE68R073	307	77	PE7301-2	287	50	PE70MP1006	311	22	PE71S6238	288	39	PE71S6359	288	77
PE6220	309	84	PE68R074	308	83	PE7301-2000CART	287	90	PE70MP1007	31							

# PART NUMBER INDEX

Note: C/R stands for the Column and/or Row location of the specific product on a given page.

Model No.	Page	C/R	Model No.	Page	C/R	Model No.	Page	C/R	Model No.	Page	C/R	Model No.	Page	C/R	Model No.	Page	C/R
PE71S8410	292	51	PE8036	275	90	PE8703	274	11	PE83CR1008	191	60	PE88X1016	277	5	PE8099	40	C7
PE71S8001	291	90	PE8307	275	91	PE8704	274	10	PE83CR1009	190	33	PE88X1017	277	10	PE8103	40	C6
PE71S8002	291	51	PE8040	280	13	PE8705	274	6	PE83CR1010	191	62	PE86X1018	277	6	PE8101	27	C7
PE71S9001	344	19	PE8044	280	98	PE8706	274	7	PE83CR1011	191	66	PE86X1019	277	11	PE8102	27	A6
PE71S9002	344	20	PE8203	283	90	PE8707	274	13	PE83CR1012	191	68	PE86X1020	277	2	PE8103	31	A7
PE71S9003	344	17	PE8210	84	56	PE8708	274	15	PE83CR1013	190	6	PE86X1021	277	3	PE8104	36	C6
PE71S9004	344	18	PE8211	84	59	PE8709	274	14	PE83CR1014	190	1	PE86X1022	277	7	PE8105	34	B5
PE73SP1000	287	65	PE8212	84	58	PE8710	274	12	PE83CR1015	190	7	PE86X1023	277	6	PE8106	43	A4
PE73SP1001	287	54	PE8213	84	52	PE8711	275	61	PE83CR1016	190	2	PE86X1024	277	12	PE8108	37	C4
PE73SP1002	287	75	PE8214	84	55	PE8712	274	19	PE83CR1017	190	8	PE86X1025	277	16	PE8109	23	D5
PE73SP1003	287	76	PE8215	84	54	PE8713	274	20	PE83CR1018	190	3	PE86X1026	277	15	PE8111	29	D4
PE73SP1004	287	37	PE8216	84	49	PE8714	274	22	PE83CR1019	190	9	PE86X1027	277	17	PE8112	30	E5
PE73SP1005	287	40	PE8217	84	51	PE8715	275	43	PE83CR1020	190	4	PE86X1028	277	22	PE8113	29	C4
PE73SP1006	287	41	PE8218	84	50	PE8716	275	42	PE83CR1021	190	10	PE86X1029	277	24	PE8114	42	E2
PE73SP1007	287	42	PE8219	84	60	PE8717	275	41	PE83CR1022	190	5	PE86X1030	277	27	PE8115	38	F7
PE73SP1008	287	45	PE8220	84	63	PE8718	275	44	PE83CR1023	190	11	PE86X1031	277	30	PE8116	38	D4
PE73SP1009	287	39	PE8221	84	62	PE8719	275	48	PE83CR1024	190	12	PE86X1032	277	34	PE8117	38	E3
PE73SP1010	287	63	PE8222	84	43	PE8720	275	53	PE83CR1025	190	13	PE86X1033	277	34	PE8118	38	D3
PE73SP1011	287	68	PE8223	84	45	PE8721	275	54	PE83CR1026	191	63	PE86X1034	277	35	PE8119	38	F7
PE73SP1012	287	69	PE8224	84	44	PE8722	275	49	PE83CR1027	190	14	PE86X1035	277	36	PE8120	38	A4
PE73SP1013	287	58	PE8225	84	46	PE8723	275	47	PE83CR1028	190	15	PE86X1036	277	37	PE8122	38	A5
PE73SP1014	287	87	PE8226	84	48	PE8724	275	50	PE83CR1029	190	17	PE86X1037	277	38	PE8123	29	B6
PE73SP1015	287	87	PE8227	84	47	PE8725	275	55	PE83CR1030	190	50	PE86X1038	277	39	PE8124	28	E7
PE73SP1016	287	59	PE8228	84	64	PE8726	275	61	PE83CR1031	190	29	PE86X1039	277	42	PE8125	38	F2
PE73SP1017	287	64	PE8229	84	66	PE8727	275	52	PE83CR1032	190	16	PE86X1040	277	28	PE8126	28	A1
PE73SP1018	287	53	PE8230	84	65	PE8728	276	60	PE83CR1033	190	52	PE86X1041	274	30	PE8128	27	E7
PE73SP1019	287	63	PE8231	84	70	PE8729	276	61	PE83CR1034	190	56	PE86X1042	274	29	PE8129	25	C3
PE73SP1020	287	80	PE8232	84	71	PE8730	276	62	PE83R000	192	37	PE86X1043	275	31	PE8130	29	C3
PE73SP1021	287	57	PE8233	84	40	PE8731	276	63	PE83R001	192	41	PE86X1044	275	32	PE8131	30	E4
PE73SP1022	287	54	PE8234	84	42	PE8732	276	64	PE83R002	192	13	PE86X1045	275	32	PE8132	38	A6
PE73SP1023	287	88	PE8235	84	67	PE8733	276	65	PE83R003	192	49	PE86X1046	275	33	PE8133	38	D6
PE73SP1024	287	88	PE8236	84	67	PE8734	276	66	PE83R004	192	18	PE86X1047	275	33	PE8136	38	B6
PE73SP1025	287	78	PE8237	84	69	PE8735	276	67	PE83R005	192	20	PE86X1048	275	37	PE8137	38	D5
PE73SP1026	287	62	PE8238	84	68	PE8736	276	68	PE83R006	192	28	PE86X1049	275	38	PE8138	38	D2
PE73SP1027	287	55	PE8239	283	96	PE8737	276	69	PE83R007	192	11	PE86X1050	275	39	PE8139	39	D1
PE73SP1028	287	81	PE8240	283	97	PE8738	274	21	PE83R008	192	15	PE86X1051	274	9	PE8140	39	A2
PE73SP1029	287	89	PE8241	283	98	PE8739	274	23	PE83R009	191	97	PE86X1052	274	16	PE8141	39	E1
PE73SP1030	287	43	PE8242	283	99	PE8740	274	25	PE83R010	191	97	PE86X1053	275	56	PE8142	38	C7
PE73SP1031	287	69	PE8243	283	97	PE8741	274	25	PE83R011	191	99	PE86X1054	276	57	PE8143	28	F7
PE73SP1032	287	69	PE8244	84	57	PE8742	275	36	PE83R012	191	74	PE86X1055	275	58	PE8144	34	A6
PE73SP1033	287	71	PE8245	84	53	PE8743	275	36	PE83R013	191	21	PE86X1056	275	59	PE8145	34	B6
PE73SP1034	287	36	PE8246	84	61	PE8744	275	40	PE83R014	191	2	PE86X1057	275	59	PE8146	37	E7
PE73SP1035	287	52	PE8247	283	3	PE8745	279	59	PE83R015	192	30	PE86X1058	275	46	PE8147	36	A1
PE73SP1036	287	51	PE8248	283	2	PE8746	279	61	PE83R016	192	4	PE86X1059	276	96	PE8148	34	C6
PE73SP1037	287	46	PE8249	84	39	PE8747	279	68	PE83R017	192	42	PE86X1060	276	97	PE8149	34	D6
PE73SP1038	287	72	PE8250	192	19	PE8748	279	58	PE83R018	192	49	PE86X1061	276	88	PE8150	23	A2
PE73SP1039	287	72	PE8251	192	19	PE8749	279	66	PE83R019	191	74	PE86X1062	276	78	PE8151	23	E7
PE73SP1040	274	3	PE8252	192	27	PE8750	279	66	PE83R020	191	69	PE86X1063	276	72	PE8152	23	E5
PE73SP1041	274	1	PE8253	192	36	PE8751	279	60	PE83R021	191	75	PE86X1064	276	89	PE8153	24	A1
PE73SP1042	274	1	PE8254	192	40	PE8752	279	64	PE83R022	191	70	PE86X1065	276	79	PE8154	41	B1
PE73SP1043	274	2	PE8255	192	43	PE8753	279	69	PE83R023	191	76	PE86X1066	276	88	PE8155	28	A7
PE73SP1044	274	2	PE8256	192	47	PE8754	279	70	PE83R024	191	71	PE86X1067	276	88	PE8156	24	B1
PE73SP1045	274	2	PE8257	191	6	PE8755	279	67	PE83R025	191	63	PE86X1068	276	84	PE8157	28	A7
PE73SP1046	274	2	PE8258	191	1	PE8756	279	67	PE83R026	191	72	PE86X1069	276	74	PE8158	43	D3
PE73SP1047	287	77	PE8259	191	3	PE8757	281	19	PE83R027	191	78	PE86X1070	276	71	PE8159	43	D1
PE73SP1048	287	70	PE8260	192	5	PE8758	281	17	PE83R028	191	73	PE86X1071	276	70	PE8160	43	D3
PE73SP1049	287	35	PE8261	192	26	PE8759	281	18	PE83R029	191	79	PE86X1072	276	90	PE8161	43	B1
PE73SP1050	287	33	PE8262	192	31	PE8760	281	30	PE83R030	191	80	PE86X1073	276	93	PE8162	42	D4
PE73SP1051	287	34	PE8263	192	24	PE8761	281	31	PE83R031	191	81	PE86X1074	276	78	PE8163	43	A7
PE73SP1052	287	38	PE8264	192	25	PE8762	281	32	PE83R032	191	82	PE86X1075	276	79	PE8164	43	D3
PE73SP1053	287	44	PE8265	191	89	PE8763	281	25	PE83R033	192	39	PE86X1076	276	85	PE8165	28	E3
PE73SP1054	287	66	PE8266	191	89	PE8764	280	11	PE83R034	192	45	PE86X1077	276	77	PE8166	28	C1
PE73SP1055	287	82	PE8267	191	88	PE8765	280	12	PE83R035	192	33	PE86X1078	276	91	PE8167	23	C2
PE73SP1056	287	86	PE8268	192	6	PE8766	339	37	PE83R036	192	34	PE86X1079	276	80	PE8168	43	A7
PE73SP1057	287	85	PE8269	191	90	PE8767	339	36	PE83R037	192	35	PE86X1080	276	81	PE8169	29	C5
PE73SP1058	287	84	PE8270	192	7	PE8768	339	35	PE83R038	192	14	PE86X1081	276	82	PE8170	25	A5
PE73SP1059	287	40	PE8271	191	91	PE8769	339	34	PE83R039	191	83	PE86X1082	276	82	PE8171	38	D3
PE73SP1060	287	71	PE8272	191	93	PE8770	339	32	PE83R040	191	85	PE86X1083	276	86	PE8172	28	E3
PE73SP1061	287	72	PE8273	192	23	PE8771	280	14	PE83R041	191	86	PE86X1084	276	86	PE8173	28	C1
PE73SP1062	287	88	PE8274	192	30	PE8772	280	16	PE83R042	191	87	PE86X1085	276	83	PE8174	23	C2
PE73SP1063	287	86	PE8275	192	32	PE8773	280	15	PE83R043	191	82	PE86X1086	278	51	PE8175	24	B3
PE73SP1064	287	84	PE8276	190	47	PE8774	281	33	PE83R044	192	22	PE86X1087	278	52	PE8176	35	C1
PE73SP1065	287	75	PE8277	190	54	PE8775	281	34	PE83R045	192	29	PE86X1088	278	53	PE8177	37	D4
PE73SP1066	287	66	PE8278	190	59	PE8776	281	34	PE83R046	192	29	PE86X1089	278	50	PE8178	37	D4
PE73SP1067	287	66	PE8279	191	64	PE8777	281	36	PE83R047	192	80	PE86X1090	278	50	PE8179	40	B1
PE73SP1068	287	82	PE8280	191	65	PE8778	281										

# PART NUMBER INDEX

Note: C/R stands for the Column and/or Row location of the specific product on a given page.

Model No.	Page	C/R	Model No.	Page	C/R	Model No.	Page	C/R	Model No.	Page	C/R	Model No.	Page	C/R	Model No.	Page	C/R
PE9375	45	B5	PE9312	37	C2	PE9645	17	E4	PE9786	26	B7	PE9860NF-20	324	53	PE91054	37	D1
PE9376	45	E4	PE9313	37	B1	PE9647	17	E5	PE9787	26	E1	PE9860SF-20	324	56	PE91055	37	D3
PE9377	45	A5	PE9314	26	D7	PE9648	17	A6	PE9801	330	34	PE9860-20	326	43	PE91056	37	C1
PE9378	45	C5	PE9317	26	D6	PE9649	19	C1	PE9802	330	45	PE9861NF-10	324	57	PE91057	37	D3
PE9379	31	B6	PE9318	26	C7	PE9650	19	A3	PE9803	329	98	PE9861SF-10	324	60	PE91058	37	E1
PE9380	32	D3	PE9319	26	E6	PE9651	19	D1	PE9804	330	36	PE9861-15	326	44	PE91059	37	E3
PE9382	28	D2	PE9320	25	B7	PE9652	19	C3	PE9805	330	42	PE9861NF-15	324	58	PE91060	37	E5
PE9383	28	A1	PE9321	41	D7	PE9653	19	B5	PE9806	329	99	PE9861SF-15	324	61	PE91061	37	C3
PE9384	32	B3	PE9322	26	C6	PE9654	33	C5	PE9809	330	90	PE9861-20	326	45	PE91062	35	A1
PE9385	30	A6	PE9323	26	A6	PE9655	35	D4	PE9810	330	37	PE9861NF-20	324	59	PE91063	34	C7
PE9386	25	A3	PE9324	25	E5	PE9656	35	E4	PE9811	330	44	PE9861SF-20	324	62	PE91064	37	B4
PE9387	25	E3	PE9325	26	B7	PE9658	19	E1	PE9812	329	85	PE9861-20	326	46	PE91065	39	D5
PE9388	28	B6	PE9326	27	A1	PE9659	19	D3	PE9813A	329	84	PE9862NF-15	324	63	PE91066	37	E2
PE9389	29	E7	PE9327	26	A7	PE9660	18	A4	PE9819	330	13	PE9862SF-15	324	65	PE91068	39	A4
PE9390	27	C3	PE9328	26	E7	PE9661	18	A2	PE9820	330	61	PE9862-15	326	48	PE91069	26	A3
PE9391	43	B6	PE9329	23	D4	PE9662	18	B2	PE9821	331	96	PE9862NF-20	324	64	PE91070	17	D7
PE9392	42	C2	PE9330	23	C4	PE9663	18	C5	PE9822	331	96	PE9862SF-20	324	66	PE91072	39	B4
PE9393	40	A2	PE9331	41	D2	PE9664	18	D5	PE9823	331	2	PE9862-20	326	49	PE91073	42	A1
PE9394	40	D2	PE9332	41	C2	PE9665	18	C2	PE9824	331	11	PE9863NF-10	325	69	PE91080	45	E3
PE9395	40	B2	PE9333	32	D7	PE9666	17	D6	PE9826	329	72	PE9863SF-10	325	71	PE91081	45	D3
PE9396	44	A1	PE9334	32	B7	PE9667	17	C6	PE9827	329	75	PE9863-10	326	50	PE91082	45	C4
PE9397	44	C3	PE9335	38	C4	PE9668	18	D2	PE9828	329	88	PE9863NF-20	325	70	PE91083	45	B4
PE9398	25	C4	PE9336	33	C5	PE9669	31	E6	PE9830	331	79	PE9863SF-20	325	72	PE91084	16	E3
PE9399	37	E4	PE9337	41	C7	PE9670	37	A6	PE9831	331	97	PE9863-20	326	74	PE91085	47	E7
PE9400	35	C3	PE9338	28	C6	PE9672	16	C7	PE9832	331	96	PE9864NF-10	325	74	PE91086	16	C3
PE9401	35	E1	PE9339	29	D7	PE9673	17	B2	PE9833	331	3	PE9864SF-10	325	77	PE91087	42	E1
PE9402	37	A5	PE9340	29	B7	PE9674	16	D7	PE9834	331	6	PE9864-10	326	53	PE91088	21	D4
PE9403	31	E1	PE9341	28	B1	PE9675	17	C2	PE9835	331	20	PE9864NF-15	325	75	PE91089	21	C5
PE9404	31	D2	PE9342	41	B5	PE9676	18	C7	PE9837	331	60	PE9864SF-15	325	78	PE91090	21	E7
PE9405	31	B2	PE9343	41	A5	PE9678	18	B7	PE9838	331	80	PE9864-15	326	54	PE91091	22	C1
PE9406	31	B6	PE9344	41	C7	PE9679	18	C5	PE9839	331	97	PE9864NF-20	325	76	PE91092	22	A7
PE9407	35	E7	PE9345	41	B7	PE9680	33	E3	PE9840	331	97	PE9864SF-20	325	79	PE91093	20	C1
PE9408	36	E6	PE9346	31	B7	PE9683	33	A4	PE9842	331	12	PE9864-20	326	55	PE91094	20	A2
PE9409	21	A3	PE9347	27	E4	PE9684	36	E4	PE9843	331	21	PE9865	330	64	PE91095	20	D2
PE9411	33	E6	PE9348	27	D7	PE9685	39	C6	PE9846	329	3	PE9866	329	1	PE91099	39	C4
PE9413	25	B5	PE9350	29	B4	PE9687	24	E3	PE9847	330	15	PE9867	330	14	PE91101	39	D4
PE9414	21	D3	PE9351	36	A5	PE9688	24	D3	PE9848	330	38	PE9868	330	23	PE91102	39	D3
PE9415	37	E3	PE9352	30	B6	PE9689	24	A4	PE9850ZF-10	324	10	PE9869	330	39	PE91103	34	B5
PE9416	43	A7	PE9353	30	D1	PE9690	33	D4	PE9850-10	325	10	PE9870	330	62	PE91104	33	E6
PE9417	43	E6	PE9354	28	D7	PE9691	35	E3	PE9850ZF-15	324	2	PE9871	330	47	PE91105	45	E7
PE9418	31	A6	PE9355	Web	C4	PE9692	33	C4	PE9851	325	11	PE9872	331	19	PE91106	45	C7
PE9419	25	D4	PE9356	21	B3	PE9693	35	A4	PE9852ZF-20	324	3	PE9873	330	33	PE91107	45	D7
PE9420	23	C3	PE9357	21	B2	PE9694	31	C7	PE9852-20	325	12	PE9874	330	12	PE91108	16	B2
PE9421	42	C4	PE9358	21	B6	PE9695	32	A4	PE9851ZF-10	324	4	PE9875	329	2	PE91109	16	D2
PE9429	28	D4	PE9359	22	A3	PE9696	24	C4	PE9852ZF-15	324	13	PE9876	331	78	PE91113	17	E5
PE9431	34	D4	PE9360	44	E4	PE9697	24	A5	PE9851NF-15	324	87	PE9877	330	47	PE91114	21	A1
PE9432	36	E5	PE9361	40	B6	PE9698	24	A5	PE9851ZF-15	324	6	PE9878	329	83	PE91115	16	A4
PE9433	34	E4	PE9362	41	A4	PE9699	41	B4	PE9851A-15	326	14	PE9879	329	89	PE91116	16	A2
PE9434	36	D6	PE9363	41	E4	PE9700	41	C4	PE9851A-20	326	15	PE9881	6	5	PE91118	16	A2
PE9435	36	A7	PE9364	41	E6	PE9701	42	E3	PE9852ZF-10	324	7	PE9881A-20	329	54	PE91119	16	C2
PE9436	17	D4	PE9365	28	C5	PE9703	36	C1	PE9852-10	326	16	PE9882	Web	3	PE91120	17	D1
PE9437	17	A5	PE9366	29	A6	PE9704	28	B7	PE9852ZF-15	324	6	PE9883	330	32	PE91121	17	C1
PE9438	32	C5	PE9367	28	B2	PE9705	26	B4	PE9852NF-20	324	9	PE9884	Web	4	PE91122	19	E1
PE9439	35	B2	PE9368	33	B3	PE9706	26	E4	PE9852A-15	325	17	PE9887-11	Web	3	PE91123	17	E2
PE9440	37	E5	PE9369	25	B4	PE9707	24	A1	PE9852-20	326	18	PE9887	329	51	PE91124	18	C1
PE9441	Web		PE9370	29	A2	PE9708	36	D1	PE9853SF-10	324	11	PE9888-11	Web	3	PE91125	18	D1
PE9442	37	B6	PE9371	31	D3	PE9709	26	A5	PE9853-10	325	19	PE9889	330	35	PE91126	18	E1
PE9443	40	A6	PE9372	31	A2	PE9710	26	C5	PE9853SF-15	324	12	PE9890	330	46	PE91127	18	E4
PE9444	40	E7	PE9373	31	E2	PE9711	24	B5	PE9853-15	325	20	PE9909	Web	3	PE91128	18	A5
PE9445	40	D4	PE9374	25	D1	PE9712	24	C5	PE9853A-20	325	21	PE9910	Web	3	PE91129	36	A3
PE9446	40	D3	PE9375	25	B1	PE9713	24	C5	PE9853NF-20	324	13	PE9911	Web	3	PE91130	44	E2
PE9448	29	A4	PE9376	24	D7	PE9714	41	A7	PE9854NF-10	324	14	PE9912	Web	3	PE91135	31	B5
PE9449	30	A5	PE9377	24	C7	PE9715	16	D3	PE9854SF-10	324	17	PE9913	Web	3	PE91136	Web	3
PE9450	30	D6	PE9378	25	A1	PE9716	16	B3	PE9854-10	325	22	PE9914	Web	3	PE91138	Web	3
PE9451	16	B6	PE9379	25	D2	PE9718	16	E4	PE9854NF-15	324	15	PE9915	Web	3	PE91140	27	E6
PE9452	16	C6	PE9380	25	C1	PE9719	16	A5	PE9854SF-15	324	18	PE9916	Web	3	PE91141	27	A7
PE9453	16	D6	PE9381	37	D7	PE9720	16	D5	PE9854-15	325	23	PE9917	Web	3	PE91144	42	B5
PE9454	17	C7	PE9382	44	A2	PE9721	43	C2	PE9854NF-20	324	19	PE9918	Web	4	PE91145	17	A4
PE9455	17	C7	PE9383	44	D4	PE9722	33	A6	PE9854SF-20	324	19	PE9950	Web	3	PE91146	17	B4
PE9456	18	D3	PE9384	44	E1	PE9723	Web		PE9854-20	326	24	PE9951	Web	3	PE91147	19	E4
PE9457	17	A7	PE9385	44	C4	PE9724	35	C5	PE9855NF-10	324	20	PE9952	Web	3	PE91148	19	D4
PE9458	17	B1	PE9386	44	C2	PE9725	35	D5	PE9855SF-10	324	23	PE9953	Web	3	PE91149	32	B2
PE9459	Web		PE9387	44	A5	PE9726	35	B4	PE9855-10	326	25	PE9954	Web	3	PE91150	Web	3
PE9460	18	B1	PE9388	44	B2	PE9727	33	E4	PE9855NF-15	324	21	PE9955	Web	3	PE91151	31	C6
PE9461	18	D4	PE9389	38	C2	PE9728	33	E4	PE9855-15	326	25	PE9956	Web	3	PE91152	36	B6
PE9462	30	C2	PE9390	33	A3	PE9729	35	C4	PE9855-20	326	26	PE9957	Web	3	PE91155	32	B1
PE9463	30	B2	PE9394	33	C2	PE9730	30	C6	PE9855NF-20	324	22	PE9958	Web	3	PE91159	16	B5
PE9464	29	C1	PE9395	37	D5	PE9731	30	D6	PE9855SF-20	324	25	PE9959	Web	3	PE91161	16	C4
PE9465	29	B1	PE9396	38	E1	PE9732	38	C1	PE9855A-20	326	27	PE9960	Web	3	PE91162	16	C5
PE9466	25	A7	PE9397	38	D1	PE9733	38	A2	PE9856NF-10	324	27	PE9961	Web	3	PE91163	Web	3
PE9467	25	D6	PE9398	38	B2	PE9734	43	E1	PE9856SF-10	3							

# PART NUMBER INDEX

Note: C/R stands for the Column and/or Row location of the specific product on a given page.

Model No.	Page	C/R	Model No.	Page	C/R	Model No.	Page	C/R	Model No.	Page	C/R	Model No.	Page	C/R	Model No.	Page	C/R
PE91407	Web		PEW12S010-3	345	57	PEWAN1041	326	80	PEWCA1029	329	5	PEWCP1059	336	91	PEWCT1096	338	3
PE91408	Web		PEW12SP4	348	47	PEWAN1042	326	81	PEWCA1030	330	28	PEWCP1060	336	93	PEWCT1097	338	7
PE91409	Web		PEW12TR0001	349	33	PEWAN1043	327	82	PEWCA1031	330	21	PEWCP1061	336	94	PEWCT1098	338	11
PE91410	Web		PEW137FS7	349	96	PEWAN1044	327	83	PEWCA1032	330	17	PEWCP1062	336	97	PEWCT1099	338	15
PE91411	Web		PEW137SP7	349	97	PEWAN1045	326	76	PEWCA1033	330	16	PEWCP1063	336	98	PEWCT1100	338	16
PE91412	Web		PEW159FS7	349	98	PEWAN1046	326	77	PEWCA1034	330	22	PEWCP1064	336	1	PEWCT1101	338	20
PE91413	Web		PEW159SP7	349	99	PEWAN1047	326	78	PEWCA1035	330	20	PEWCP1065	336	3	PEWCT1102	338	24
PE91414	Web		PEW15FS2	348	48	PEWAN1048	326	79	PEWCA1036	330	19	PEWCP1066	336	5	PEWCT1103	338	28
PE91415	Web		PEW15S010-12	345	62	PEWAN1049	326	68	PEWCA1037	330	43	PEWCP1067	336	99	PEWCT1104	338	17
PE91416	Web		PEW15S010-12	349	49	PEWAN1050	326	69	PEWCA1038	330	40	PEWCP1068	336	2	PEWCT1105	338	2
PE91417	Web		PEW15TR0001	346	35	PEWAN1051	326	70	PEWCA1039	330	41	PEWCP1069	336	4	PEWCT1106	338	25
PE91418	Web		PEW187FS7	349	1	PEWAN1052	326	71	PEWCA1040	330	56	PEWCP1070	336	6	PEWCT1107	338	29
PE91419	Web		PEW187SP7	349	2	PEWAN1053	326	72	PEWCA1041	330	54	PEWCP1071	336	7	PEWCT1108	338	18
PE91420	Web		PEW19FS3	348	50	PEWAN1054	326	73	PEWCA1042	330	49	PEWCP1072	336	9	PEWCT1109	338	22
PE91421	Web		PEW19S010-12	345	68	PEWAN1055	326	74	PEWCA1043	330	48	PEWCP1073	336	11	PEWCT1110	338	26
PE91422	Web		PEW19S010-3	345	67	PEWAN1056	326	75	PEWCA1044	330	53	PEWCP1074	336	13	PEWCT1111	338	30
PE91423	C3		PEW19SP4	349	51	PEWAN1057	326	64	PEWCA1045	330	50	PEWCP1075	336	8	PEWCT1112	338	19
PE91424	C1		PEW22TR0001	346	36	PEWAN1058	326	65	PEWCA1046	330	21	PEWCP1076	336	10	PEWCT1113	338	23
PE91425	A3		PEW22B100	342	56	PEWAN1059	326	66	PEWCA1047	330	73	PEWCP1077	336	12	PEWCT1114	338	27
PE91426	A0		PEW22B101	332	57	PEWAN1060	326	67	PEWCA1048	330	66	PEWCP1078	336	14	PEWCT1115	338	31
PE91427	B7		PEW22CA100	329	67	PEWAN1061	326	60	PEWCA1049	330	65	PEWCR1000	Web		PEWCT1116	338	3
PE91428	B1		PEW22CP010-20	334	28	PEWAN1062	326	61	PEWCA1050	330	70	PEWGH-W1000	Web		PEWGH-W1000	349	11
PE91429	E4		PEW22FS3	349	52	PEWAN1063	326	62	PEWCA1051	330	68	PEWGH-W1001	349	10	PEWGH-W1001	349	9
PE91430	C4		PEW22S010-3	345	73	PEWAN1064	326	63	PEWCA1052	330	82	PEWGH-W1002	349	8	PEWGH-W1002	349	7
PE91431	B7		PEW22TR0001	349	39	PEWAN1065	326	68	PEWCA1053	330	21	PEWGH-W1003	349	6	PEWGH-W1003	349	5
PE91432	A3		PEW22B100	342	56	PEWAN1066	326	57	PEWCA1054	330	84	PEWGH-W1004	349	4	PEWGH-W1004	349	3
PE91433	A0		PEW22B101	332	57	PEWAN1067	326	58	PEWCA1055	330	83	PEWGH-W1005	349	3	PEWGH-W1005	349	2
PE91434	B7		PEW22CA100	329	67	PEWAN1068	326	59	PEWCA1056	330	93	PEWGH-W1006	349	2	PEWGH-W1006	349	1
PE91435	B1		PEW22CP010-20	334	28	PEWAN1069	327	2	PEWCA1057	330	90	PEWGH-W1007	349	1	PEWGH-W1007	349	0
PE91436	E4		PEW22FS3	349	52	PEWAN1070	327	3	PEWCA1058	330	89	PEWGH-W1008	349	0	PEWGH-W1008	349	0
PE91437	C4		PEW22S010-3	345	73	PEWAN1071	327	97	PEWCA1059	330	91	PEWGH-W1009	349	0	PEWGH-W1009	349	0
PE91438	B7		PEW22TR0001	349	39	PEWAN1072	327	98	PEWCA1060	330	75	PEWGH-W1010	349	0	PEWGH-W1010	349	0
PE91439	E2		PEW22B100	342	56	PEWAN1073	327	93	PEWCA1061	330	1	PEWGH-W1011	349	0	PEWGH-W1011	349	0
PE91440	E5		PEW22B101	332	57	PEWAN1074	327	94	PEWCA1062	330	99	PEWGH-W1012	349	0	PEWGH-W1012	349	0
PE91441	B7		PEW22CA100	329	67	PEWAN1075	327	17	PEWCA1063	330	1	PEWGH-W1013	349	0	PEWGH-W1013	349	0
PE91442	B1		PEW22CP010-20	334	28	PEWAN1076	327	19	PEWCA1064	330	5	PEWGH-W1014	349	0	PEWGH-W1014	349	0
PE91443	E4		PEW22FS3	349	52	PEWAN1077	327	18	PEWCA1065	330	7	PEWGH-W1015	349	0	PEWGH-W1015	349	0
PE91444	C4		PEW22S010-3	345	73	PEWAN1078	327	20	PEWCA1066	330	13	PEWGH-W1016	349	0	PEWGH-W1016	349	0
PE91445	B7		PEW22TR0001	349	39	PEWAN1079	327	13	PEWCA1067	330	14	PEWGH-W1017	349	0	PEWGH-W1017	349	0
PE91446	E2		PEW22B100	342	56	PEWAN1080	327	15	PEWCA1068	330	15	PEWGH-W1018	349	0	PEWGH-W1018	349	0
PE91447	E5		PEW22B101	332	57	PEWAN1081	327	14	PEWCA1069	330	16	PEWGH-W1019	349	0	PEWGH-W1019	349	0
PE91448	B7		PEW22CA100	329	67	PEWAN1082	327	16	PEWCA1070	330	81	PEWGH-W1020	349	0	PEWGH-W1020	349	0
PE91449	B1		PEW22CP010-20	334	28	PEWAN1083	327	8	PEWCA1071	330	97	PEWGH-W1021	349	0	PEWGH-W1021	349	0
PE91450	E2		PEW22FS3	349	52	PEWAN1084	327	10	PEWCA1072	330	96	PEWGH-W1022	349	0	PEWGH-W1022	349	0
PE91451	C3		PEW22S010-3	345	73	PEWAN1085	327	9	PEWCA1073	330	11	PEWGH-W1023	349	0	PEWGH-W1023	349	0
PE91452	B7		PEW22TR0001	349	39	PEWAN1086	327	11	PEWCA1074	330	10	PEWGH-W1024	349	0	PEWGH-W1024	349	0
PE91453	E2		PEW22B100	342	56	PEWAN1087	327	12	PEWCA1075	330	10	PEWGH-W1025	349	0	PEWGH-W1025	349	0
PE91454	E5		PEW22B101	332	57	PEWAN1088	327	11	PEWCA1076	330	10	PEWGH-W1026	349	0	PEWGH-W1026	349	0
PE91455	B7		PEW22CA100	329	67	PEWAN1089	327	12	PEWCA1077	330	94	PEWGH-W1027	349	0	PEWGH-W1027	349	0
PE91456	B1		PEW22CP010-20	334	28	PEWAN1090	327	12	PEWCA1078	330	99	PEWGH-W1028	349	0	PEWGH-W1028	349	0
PE91457	E2		PEW22FS3	349	52	PEWAN1091	327	13	PEWCA1079	330	98	PEWGH-W1029	349	0	PEWGH-W1029	349	0
PE91458	C3		PEW22S010-3	345	73	PEWAN1092	327	14	PEWCA1080	330	99	PEWGH-W1030	349	0	PEWGH-W1030	349	0
PE91459	B7		PEW22TR0001	349	39	PEWAN1093	327	14	PEWCA1081	330	99	PEWGH-W1031	349	0	PEWGH-W1031	349	0
PE91460	E2		PEW22B100	342	56	PEWAN1094	327	15	PEWCA1082	330	94	PEWGH-W1032	349	0	PEWGH-W1032	349	0
PE91461	E5		PEW22B101	332	57	PEWAN1095	327	15	PEWCA1083	330	94	PEWGH-W1033	349	0	PEWGH-W1033	349	0
PE91462	B7		PEW22CA100	329	67	PEWAN1096	327	16	PEWCA1084	330	85	PEWGH-W1034	349	0	PEWGH-W1034	349	0
PE91463	B1		PEW22CP010-20	334	28	PEWAN1097	327	16	PEWCA1085	330	85	PEWGH-W1035	349	0	PEWGH-W1035	349	0
PE91464	E2		PEW22FS3	349	52	PEWAN1098	327	17	PEWCA1086	330	76	PEWGH-W1036	349	0	PEWGH-W1036	349	0
PE91465	C3		PEW22S010-3	345	73	PEWAN1099	327	17	PEWCA1087	330	71	PEWGH-W1037	349	0	PEWGH-W1037	349	0
PE91466	B7		PEW22TR0001	349	39	PEWAN1100	327	17	PEWCA1088	330	77	PEWGH-W1038	349	0	PEWGH-W1038	349	0
PE91467	E2		PEW22B100	342	56	PEWAN1101	327	17	PEWCA1089	330	58	PEWGH-W1039	349	0	PEWGH-W1039	349	0
PE91468	E5		PEW22B101	332	57	PEWAN1102	327	18	PEWCA1090	330	59	PEWGH-W1040	349	0	PEWGH-W1040	349	0
PE91469	B7		PEW22CA100	329	67	PEWAN1103	327	18	PEWCA1091	330	59	PEWGH-W1041	349	0	PEWGH-W1041	349	0
PE91470	B1		PEW22CP010-20	334	28	PEWAN1104	327	18	PEWCA1092	330	30	PEWGH-W1042	349	0	PEWGH-W1042	349	0
PE91471	E2		PEW22FS3	349	52	PEWAN1105	327	19	PEWCA1093	330	30	PEWGH-W1043	349	0	PEWGH-W1043	349	0
PE91472	C3		PEW22S010-3	345	73	PEWAN1106	327	19	PEWCA1094	330	30	PEWGH-W1044	349	0	PEWGH-W1044	349	0
PE91473	B7		PEW22TR0001	349	39	PEWAN1107	327	19	PEWCA1095	330	8	PEWGH-W1045	349	0	PEWGH-W1045	349	0
PE91474	E2		PEW22B100	342	56	PEWAN1108	327	19	PEWCA1096	330	9	PEWGH-W1046	349	0	PEWGH-W1046	349	0
PE91475	E5		PEW22B101	332	57	PEWAN1109	327	19	PEWCA1097	330	9	PEWGH-W1047	349	0	PEWGH-W1047	349	0
PE91476	B7		PEW22CA100	329	67	PEWAN1110	327	19	PEWCA1098	330	9	PEWGH-W1048	349	0	PEWGH-W1048	349	0
PE91477	B1		PEW22CP010-20	334	28	PEWAN1111	327	19	PEWCA1099	330	9	PEWGH-W1049	349	0	PEWGH-W1049	349	0
PE91478	E2		PEW22FS3	349	52	PEWAN1112	327	19	PEWCA1100	330	9	PEWGH-W1050	349	0	PEWGH-W1050	349	0
PE91479	C3		PEW22S010-3	345	73	PEWAN1113	327	19	PEWCA1101	330	9	PEWGH-W1051	349	0	PEWGH-W1051	349	0
PE91480	B7		PEW22TR0001	349	39	PEWAN1114	327	5	PEWCA1102	330	9	PEWGH-W1052	349	0	PEWGH-W1052	349	0
PE91481	E2		PEW22B100	342	56	PEWAN1115	327	4	PEWCA1103	330	71	PEWGH-W1053	349	0	PEWGH-W1053	349	0
PE91482	E5		PEW22B101														

# 50-OHM CONVERSION TABLE

## (dBm - volts- watts)

dBm	V	Po
+53	100.0	200W
+50	70.7	100W
+49	64.0	80W
+48	58.0	64W
+47	50.0	50W
+46	44.5	40W
+45	40.0	32W
+44	32.5	25W
+43	32.0	20W
+42	28.0	16W
+41	26.2	12.5W
+40	22.5	10W
+39	20.0	8W
+38	18.0	6.4W
+37	16.0	5W
+36	14.1	4W
+35	12.5	3.2W
+34	11.5	2.5W
+33	10.0	2W
+32	9.0	1.6W
+31	8.0	1.25W
+30	7.10	1.0W
+29	6.40	800 mW
+28	5.80	640 mW
+27	5.00	500 mW
+26	4.45	400 mW
+25	4.00	320 mW
+24	3.55	250 mW
+23	3.20	200 mW
+22	2.80	160 mW
+21	2.52	125 mW
+20	2.25	100 mW
+19	2.00	80 mW
+18	1.80	64 mW
+17	1.60	50 mW
+16	1.41	40 mW
+15	1.25	32 mW
+14	1.15	25 mW
+13	1.00	20 mW
+12	0.90	16 mW
+11	0.80	12.5 mW
+10	0.71	10 mW
+9	0.64	8 mW
+8	0.58	6.4 mW
+7	0.50	5 mW
+6	0.45	4 mW
+5	0.40	3.2 mW
+4	0.36	2.5 mW
+3	0.32	2.0 mW

dBm	V	Po
+2	0.28	1.6 mW
+1	0.25	1.25 mW
0	0.23	1.0 mW
-1	0.20	.80 mW
-2	0.18	.64 mW
-3	0.16	.50 mW
-4	0.14	.40 mW
-5	0.13	.32 mW
-6	0.12	.25 mW
-7	0.10	.20 mW
-8	0.09	.16 mW
-9	0.08	.125 mW
-10	0.07	.10 mW
-11	0.06	
-12	0.06	
-13	0.05	
-14	0.05	
-15	0.04	
-16	0.0355	
dBm	mV	Po
-17	31.5	
-18	28.5	
-19	25.1	
-20	22.5	.01 mW
-21	20.0	
-22	17.9	
-23	15.9	
-24	14.1	
-25	12.8	
-26	11.5	
-27	10.0	
-28	8.9	
-29	8.0	
-30	7.1	.001 mW
-31	6.25	
-32	5.8	
-33	5.0	
-34	4.5	
-35	4.0	
-36	3.5	
-37	3.2	
-38	2.85	
-39	2.5	
-40	2.25	.1 µW
-41	2.0	
-42	1.8	
-43	1.6	
-44	1.4	
-45	1.25	

dBm	mV	Po
-46	1.18	
-47	1.0	
-48	0.9	
-49	0.8	
-50	0.71	.01 µW
-51	0.64	
-52	0.57	
-53	0.5	
-54	0.45	
-55	0.4	
-56	0.351	
-57	0.32	
-58	0.286	
-59	0.251	
-60	0.225	.001 µW
-61	0.2	
-62	0.18	
-63	0.16	
-64	0.141	
dBm	µV	Po
-65	128	
-66	115	
-67	100	
-68	90	
-69	80	
-70	71	.1 nW
-71	65	
-72	58	
-73	50	
-74	45	
-75	40	
-76	35	
-77	32	
-78	29	
-79	25	
-80	22.5	.01 nW
-81	20	
-82	18	
-83	16	
-84	11.1	
-85	12.9	
-86	11.5	
-87	10.0	
-88	9.0	
-89	8.0	
-90	7.1	.001 nW
-91	6.1	
-92	5.75	
-93	5.0	

dBm	µV	Po
-94	4.5	
-95	4.0	
-96	3.51	
-97	3.2	
-98	2.9	
-99	2.51	
-100	2.25	.1 pW
-101	2.0	
-102	1.8	
-103	1.6	
-104	1.41	
-105	1.27	
-106	1.18	
dBm	nV	Po
-107	1000	
-108	900	
-109	800	
-110	710	.01 pW
-109	640	
-112	580	
-113	500	
-114	450	
-115	400	
-116	355	
-117	825	
-118	285	
-119	251	
-120	225	.001 pW
-121	200	
-122	180	
-123	160	
-124	141	
-125	128	
-126	117	
-127	100	
-128	90	
-129	80	
-130	71	.1 fW
-131	61	
-132	58	
-133	50	
-134	45	
-135	40	
-136	35	
-137	33	
-138	29	
-139	25	
-140	23	.01 fW



Technical Support  
+1 (949) 261-1920



Same-Day Shipping,  
Even Custom  
Cable Assemblies

# RETURN LOSS CONVERSION TABLE

Return Loss (dBm)	VSWR
46.064	1.01
40.086	1.02
36.607	1.03
34.151	1.04
32.256	1.05
30.714	1.06
29.417	1.07
28.299	1.08
27.318	1.09
26.444	1.10
25.658	1.11
24.943	1.12
24.289	1.13
23.686	1.14
23.127	1.15
22.607	1.16
22.120	1.17
21.664	1.18
21.234	1.19
20.828	1.20
20.443	1.21
20.079	1.22
19.732	1.23
19.401	1.24
19.085	1.25
18.783	1.26
18.493	1.27
18.216	1.28
17.949	1.29
17.690	1.30
17.445	1.31
17.207	1.32
16.977	1.33
16.755	1.34
16.540	1.35
16.332	1.36
16.131	1.37
15.936	1.38
15.747	1.39
15.563	1.40
15.385	1.41
15.211	1.42
15.043	1.43
14.879	1.44
14.719	1.45
14.564	1.46
14.412	1.47
14.264	1.48
14.120	1.49
13.979	1.50

Return Loss (dBm)	VSWR
13.842	1.51
13.708	1.52
13.577	1.53
13.449	1.54
13.324	1.55
13.201	1.56
13.081	1.57
12.964	1.58
12.849	1.59
12.736	1.60
12.625	1.61
12.518	1.62
12.412	1.63
12.308	1.64
12.207	1.65
12.107	1.66
12.009	1.67
11.913	1.68
11.818	1.69
11.725	1.70
11.634	1.71
11.545	1.72
11.457	1.73
11.370	1.74
11.285	1.75
11.202	1.76
11.120	1.77
11.039	1.78
10.960	1.79
10.881	1.80
10.804	1.81
10.729	1.82
10.654	1.83
10.581	1.84
10.509	1.85
10.437	1.86
10.367	1.87
10.298	1.88
10.230	1.89
10.163	1.90
10.097	1.91
10.032	1.92
9.968	1.93
9.904	1.94
9.842	1.95
9.780	1.96
9.720	1.97
9.660	1.98
9.601	1.99
9.542	2.00

Return Loss (dBm)	VSWR
9.485	2.01
9.428	2.02
9.372	2.03
9.317	2.04
9.262	2.05
9.208	2.06
9.155	2.07
9.103	2.08
9.051	2.09
8.999	2.10
8.949	2.11
8.899	2.12
8.849	2.13
8.800	2.14
8.752	2.15
8.705	2.16
8.657	2.17
8.611	2.18
8.565	2.19
8.519	2.20
8.474	2.21
8.430	2.22
8.386	2.23
8.342	2.24
8.299	2.25
8.257	2.26
8.215	2.27
8.173	2.28
8.138	2.29
8.091	2.30
8.051	2.31
8.011	2.32
7.972	2.33
7.933	2.34
7.894	2.35
7.856	2.36
7.818	2.37
7.781	2.38
7.744	2.39
7.707	2.40
7.671	2.41
7.635	2.42
7.599	2.43
7.564	2.44
7.529	2.45
7.494	2.46
7.460	2.47
7.426	2.48
7.393	2.49
7.360	2.50

Return Loss (dBm)	VSWR
7.327	2.51
7.294	2.52
7.262	2.53
7.230	2.54
7.198	2.55
7.167	2.56
7.135	2.57
7.105	2.58
7.074	2.59
7.044	2.60
7.014	2.61
6.984	2.62
6.954	2.63
6.925	2.64
6.896	2.65
6.867	2.66
6.839	2.67
6.811	2.68
6.783	2.69
6.755	2.70
6.728	2.71
6.700	2.72
6.673	2.73
6.646	2.74
6.620	2.75
6.594	2.76
6.567	2.77
6.541	2.78
6.516	2.79
6.490	2.80
6.465	2.81
6.440	2.82
6.415	2.83
6.390	2.84
6.366	2.85
6.341	2.86
6.317	2.87
6.293	2.88
6.270	2.89
6.246	2.90
6.223	2.91
6.200	2.92
6.177	2.93
6.154	2.94
6.131	2.95
6.109	2.96
6.086	2.97
6.064	2.98
6.042	2.99
6.021	3.00

Return Loss (dBm)	VSWR
5.999	3.01
5.970	3.02
5.956	3.03
5.935	3.04
5.914	3.05
5.893	3.06
5.872	3.07
5.852	3.08
5.832	3.09
5.811	3.10
5.791	3.11
5.771	3.12
5.751	3.13
5.732	3.14
5.712	3.15
5.693	3.16
5.674	3.17
5.654	3.18
5.635	3.19
5.617	3.20
5.598	3.21
5.579	3.22
5.561	3.23
5.542	3.24
5.524	3.25
5.506	3.26
5.488	3.27
5.470	3.28
5.452	3.29
5.435	3.30
5.417	3.31
5.400	3.32
5.383	3.33
5.365	3.34
5.348	3.35
5.331	3.36
5.315	3.37
5.298	3.38
5.281	3.39
5.265	3.40
5.248	3.41
5.232	3.42
5.216	3.43
5.200	3.44
5.184	3.45
5.168	3.46
5.152	3.47
5.137	3.48
5.121	3.49
5.105	3.50

# MOUNTING HOLES

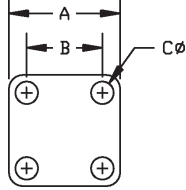

CODE	A	B	C
A01	.500	.340	.102
A02	.687	.500	.109
A03	.687	.500	#3-56 TAP
A04	.687	.500	.125
A05	1.000	.718	.125
A06	.750	.531	.140
A07	.750	.531	.125
A08	1.190	.906	.125
A09	.687	.500	#4-40 TAP
A10	.687	.500	.136
A11	1.250	.975	.147
A12	2.000	1.440	.257
A13	1.000	.718	.141
A14	1.000	.718	.144
A15	.687	.500	.104
A16	.750	.531	.136
A17	.375	.232	.067
A18	.625	.437	.094
A19	1.000	.718	#6-32 TAP
A20	.500	.340	#2-56 TAP
A21	1.250	.975	.142
A22	.375	.232	.093

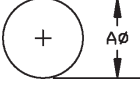

CODE	A
F01	.250
F02	.500
F03	.630
F04	1.200
F05	.380
F06	.450
F07	.200
F08	.362
F09	.220
F10	.317
F11	4.83mm
F12	.390

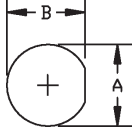

CODE	A	B
B01	.195	.177
B02	.250	.235
B03	.330	.295
B04	.380	.350
B05	.440	.410
B06	.512	.480
B07	.760	.720
B08	.565	.537
B09	.314	.296
B10	.140	.126
B11	.695	.655
B12	.625	.575
B13	.405	.361
B14	.277	.252
B15	.630	.596
B16	.317	.285
B17	.284	.268

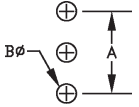

CODE	A	B
J01	.200	.046

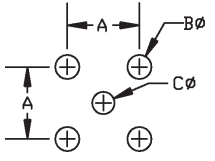

CODE	A	B	C
D01	.200	.067	.062
D02	.200	.067	.046
D03	.100	.031	.031
D04	.200	.052	.052
D05	.260	.067	.043
D06	.200	.052	.047
D07	.200	.055	.043
D08	.200	.067	.035
D09	.200	.055	.028
D10	.200	.055	.035
D11	.320	.091	.031
D12	.400	.062	.062
D13	.320	.091	.091
D14	.340	.091	.043
D15	.164	.067	.091
D16	.500	.126	.440
D17	.380	.083	.043

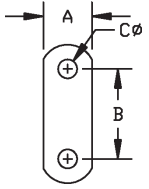

CODE	A	B	C
C01	.223	.481	.102
C02	.260	.481	.102
C03	.192	.328	.067
C04	.640	1.000	.125
C05	.275	.481	.102
C06	.230	.354	.067
C07	.188	.328	.093

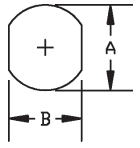

CODE	A	B
G01	.640	.546
G02	.380	.340
G03	.765	.712
G04	.362	.323
G05	.236	.197
G06	.217	.177
G07	.380	.310
G08	1.161	1.000

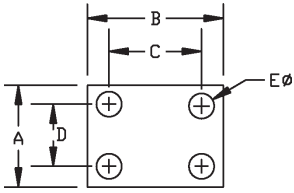

CODE	A	B	C	D	E
E01	.375	.500	.340	.222	.093

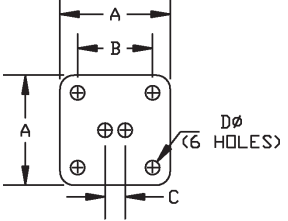

CODE	A	B	C	D
H01	.687	.500	.125	.045

# CONNECTOR IDENTIFIER

SPECIFICATIONS SHOWN ARE INTENDED FOR IDENTIFICATION PURPOSES ONLY

<b>1.0/2.3 SLIDE ON</b>	<b>PLUG</b>	
	<b>JACK</b>	
<b>1.85 mm**</b>	<b>MALE</b>	
	<b>FEMALE</b>	
<b>2.4 mm**</b>	<b>MALE</b>	
	<b>FEMALE</b>	
<b>2.92 mm*</b>	<b>MALE</b>	
	<b>FEMALE</b>	
<b>3.5 mm*</b>	<b>MALE</b>	
	<b>FEMALE</b>	
<b>7 mm</b>	<b>PLUG</b>	
	<b>JACK</b>	
<b>7/16</b>	<b>PLUG</b>	
	<b>JACK</b>	
<b>3/4-20 TWINAX</b>	<b>MALE</b>	
	<b>FEMALE</b>	
<b>10 - 32</b>	<b>MALE</b>	
	<b>FEMALE</b>	
<b>BANANA</b>	<b>PLUG</b>	
	<b>JACK</b>	
<b>BNC</b>	<b>MALE</b>	
	<b>FEMALE</b>	
<b>REVERSE POLARITY BNC</b>	<b>MALE</b>	
	<b>FEMALE</b>	
<b>75 OHM BNC</b>	<b>MALE</b>	
	<b>FEMALE</b>	











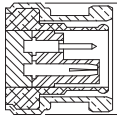
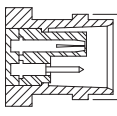
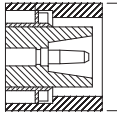
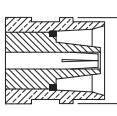
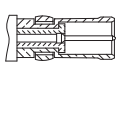
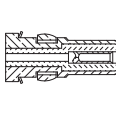
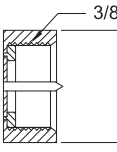
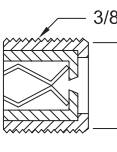
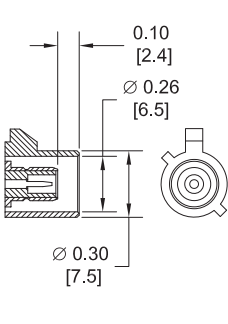
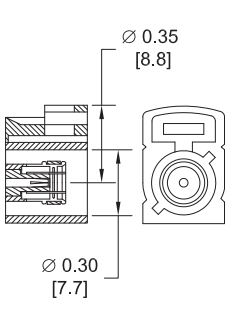









\*SMA, 2.92mm, & 3.5mm CONNECTORS WILL MATE MECHANICALLY & ELECTRICALLY TO EACH OTHER.

\*\*1.85mm & 2.4mm CONNECTORS WILL MATE MECHANICALLY & ELECTRICALLY TO EACH OTHER.

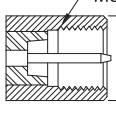
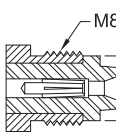
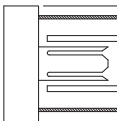

# CONNECTOR IDENTIFIER

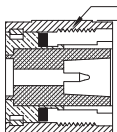
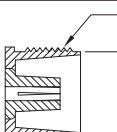
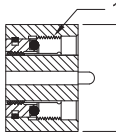
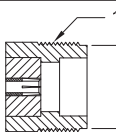
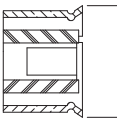
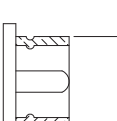
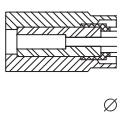

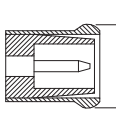
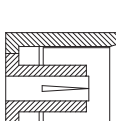
SPECIFICATIONS SHOWN ARE INTENDED FOR IDENTIFICATION PURPOSES ONLY

<b>BNC TWINAX</b>	<b>PLUG</b>	 Ø 0.57" [14.5mm]				
	<b>JACK</b>	 Ø 0.44" [11.1mm]				
<b>C</b>	<b>MALE</b>	 Ø 0.75" [19.1mm]				
	<b>FEMALE</b>	 Ø 0.60" [15.2mm]				
<b>D SUBMINIATURE</b>	<b>PLUG</b>	 Ø 0.19" [4.8mm]				
	<b>RECEPTACLE</b>	 Ø 0.15" [3.9mm]				
<b>F</b>	<b>MALE</b>	 3/8-32 7/16 HEX				
	<b>FEMALE</b>	 3/8-32 Ø 0.34 [8.5]				
<b>FAKRA</b>	<b>PLUG</b>	 0.10 [2.4] Ø 0.26 [6.5] Ø 0.30 [7.5]				
	<b>JACK</b>	 Ø 0.35 [8.8] Ø 0.30 [7.7]				
<b>FAKRA</b>	<b>COMPLETE KEY CODE INFO</b>	<b>CODE</b>	<b>JACK</b>	<b>PLUG</b>	<b>COLOR</b>	<b>APPLICATION</b>
		<b>A</b>			BLACK	RADIO WITH PHANTOM SUPPLY
		<b>B</b>			WHITE	RADIO WITHOUT PHANTOM SUPPLY
		<b>C</b>			BLUE	GPS: TELEMATICS OR NAVIGATION
		<b>D</b>			BORDEAUX	GSM: CELLULAR PHONE
<b>H</b>			VIOLET	GPS: TELEMATICS AND NAVIGATION		
<b>I</b>			BEIGE	BLUETOOTH		
<b>K</b>			CURRY	RADIO WITH I.F. OUTPUT (ANTENNA DIVERSITY)		
<b>Z</b>			WATER BLUE	NEUTRAL CODING		
<b>FME</b>	<b>PLUG</b>	 M8 X P.75 Ø 0.37 [9.5]				
	<b>JACK</b>	 M8 X P.75 Ø 0.29 [7.3]				
<b>GR874</b>	<b>PLUG</b>	 Ø 0.81 [20.6]				
	<b>JACK</b>					
<b>HN</b>	<b>MALE</b>	 3/4-20 Ø 0.90 [22.9]				
	<b>FEMALE</b>	 3/4-20 Ø 0.67 [17.1]				
<b>LC</b>	<b>MALE</b>	 1-1/4-18 1-1/2 HEX				
	<b>FEMALE</b>	 1-1/4-18 Ø 1.17 [29.6]				
<b>UMCX</b>	<b>PLUG</b>	 Ø 0.10 [2.5]				
	<b>JACK</b>	 Ø 0.08 [2.0]				
<b>MC-CARD</b>	<b>PLUG</b>	 Ø 0.087 [2.2]				
	<b>JACK</b>					
<b>MCX</b>	<b>PLUG</b>	 Ø 0.15 [3.7]				
	<b>JACK</b>	 Ø 0.20 [5.0]				

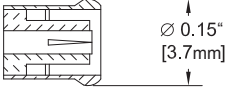
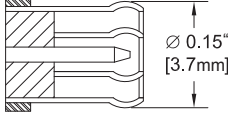
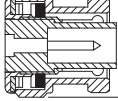
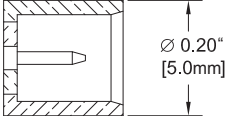
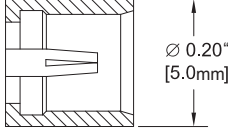
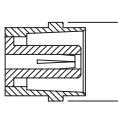
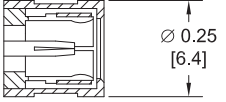
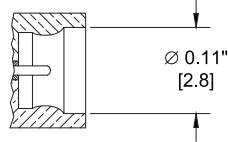
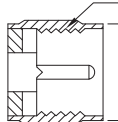
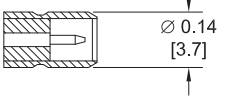
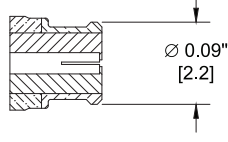
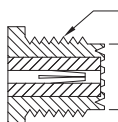
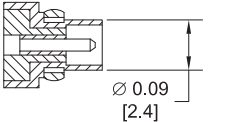
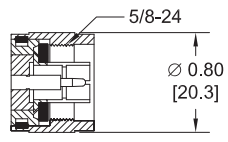
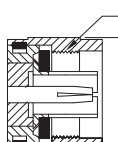

# CONNECTOR IDENTIFIER

SPECIFICATIONS SHOWN ARE INTENDED FOR IDENTIFICATION PURPOSES ONLY

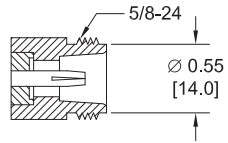
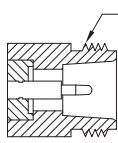
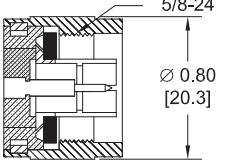
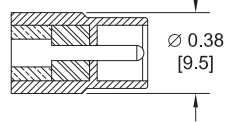
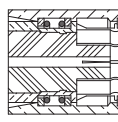
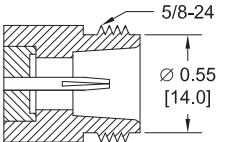
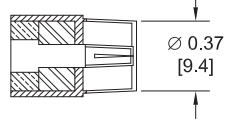
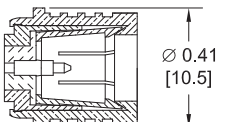
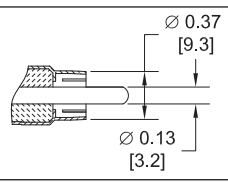
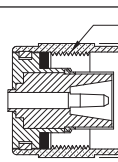
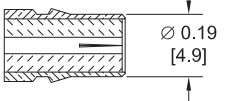
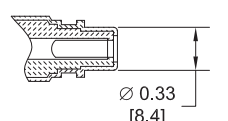
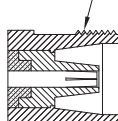
<b>REVERSE POLARITY MCX</b>	<b>PLUG</b>	 Ø 0.15" [3.7mm]	<b>75 OHM MCX</b>	<b>PLUG</b>	 Ø 0.15" [3.7mm]	<b>MHV</b>	<b>MALE</b>	 Ø 0.57" [14.5mm]
	<b>JACK</b>	 Ø 0.20" [5.0mm]		<b>JACK</b>	 Ø 0.20" [5.0mm]		<b>FEMALE</b>	 Ø 0.44" [11.1mm]
<b>MINI 75 OHM SMB</b>	<b>PLUG</b>	 Ø 0.25 [6.4]	<b>MINI SMP</b>	<b>MALE</b>	 Ø 0.11" [2.8]	<b>MINI-UHF</b>	<b>MALE</b>	 3/8-24 Ø 0.45 [11.5]
	<b>JACK</b>	 Ø 0.14 [3.7]		<b>FEMALE</b>	 Ø 0.09" [2.2]		<b>FEMALE</b>	 3/8-24 Ø 0.31 [7.8]
<b>MMCX</b>	<b>PLUG</b>	 Ø 0.09 [2.4]	<b>N</b>	<b>MALE</b>	 5/8-24 Ø 0.80 [20.3]	<b>REVERSE POLARITY N</b>	<b>MALE</b>	 5/8-24 Ø 0.80 [20.3]
	<b>JACK</b>	 Ø 0.14 [3.5]		<b>FEMALE</b>	 5/8-24 Ø 0.55 [14.0]		<b>FEMALE</b>	 5/8-24 Ø 0.55 [14.0]
<b>75 OHM N</b>	<b>MALE</b>	 5/8-24 Ø 0.80 [20.3]	<b>PAL</b>	<b>PLUG</b>	 Ø 0.38 [9.5]	<b>POSITIVE SNAP</b>	 Ø 0.39 [9.9]	
	<b>FEMALE</b>	 5/8-24 Ø 0.55 [14.0]		<b>JACK</b>	 Ø 0.37 [9.4]			
<b>QMA</b>	<b>MALE</b>	 Ø 0.41 [10.5]	<b>RCA</b>	<b>PLUG</b>	 Ø 0.37 [9.3] Ø 0.13 [3.2]	<b>SC</b>	<b>MALE</b>	 11/16-24 Ø 0.80 [20.3]
	<b>FEMALE</b>	 Ø 0.19 [4.9]		<b>JACK</b>	 Ø 0.33 [8.4]		<b>FEMALE</b>	 11/16-24 Ø 0.63 [15.9]

# CONNECTOR IDENTIFIER

SPECIFICATIONS SHOWN ARE INTENDED FOR IDENTIFICATION PURPOSES ONLY

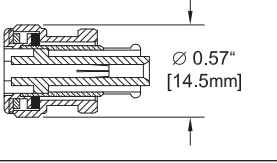
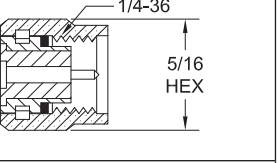
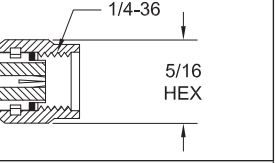
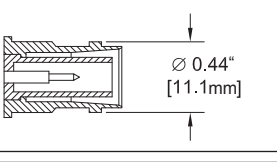
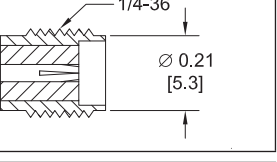
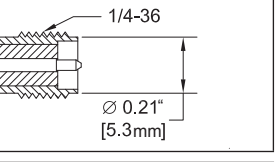
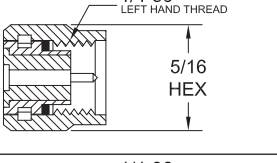
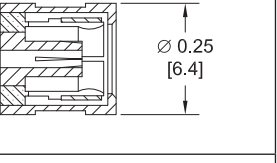
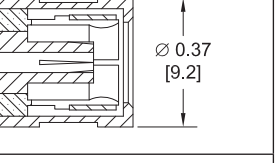
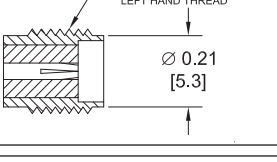
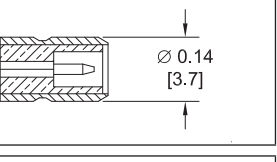
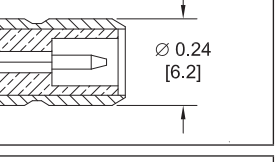
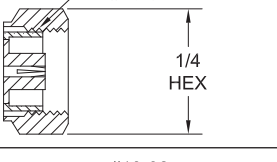
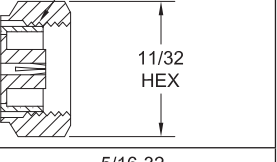
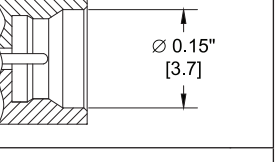
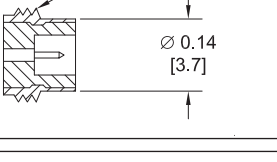
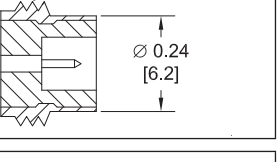
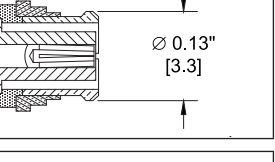
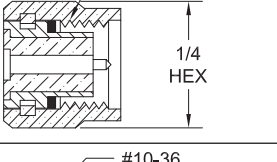
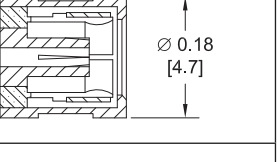
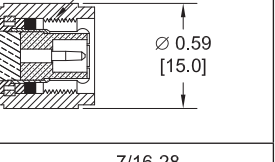
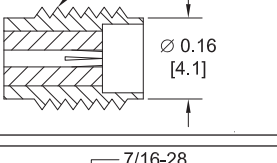
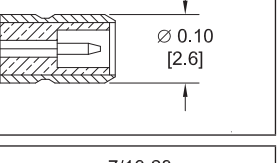
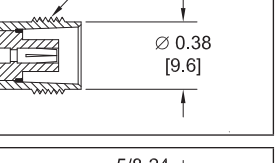
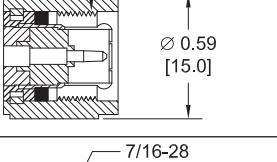
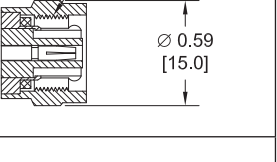
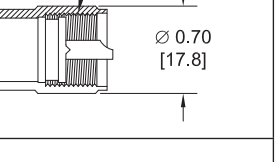
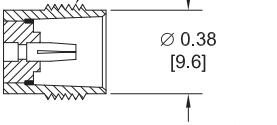
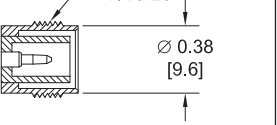
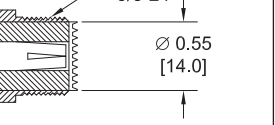
<b>SHV</b>	<b>PLUG</b>	 Ø 0.57" [14.5mm]	<b>SMA*</b>	<b>MALE</b>	 1/4-36 5/16 HEX	<b>REVERSE POLARITY SMA</b>	<b>MALE</b>	 1/4-36 5/16 HEX
	<b>JACK</b>	 Ø 0.44" [11.1mm]		<b>FEMALE</b>	 1/4-36 Ø 0.21 [5.3]		<b>FEMALE</b>	 1/4-36 Ø 0.21" [5.3mm]
<b>SMA REVERSE THREAD</b>	<b>MALE</b>	 1/4-36 LEFT HAND THREAD 5/16 HEX	<b>SMB</b>	<b>PLUG</b>	 Ø 0.25 [6.4]	<b>75 OHM SMB</b>	<b>PLUG</b>	 Ø 0.37 [9.2]
	<b>FEMALE</b>	 1/4-36 LEFT HAND THREAD Ø 0.21 [5.3]		<b>JACK</b>	 Ø 0.14 [3.7]		<b>JACK</b>	 Ø 0.24 [6.2]
<b>SMC</b>	<b>PLUG</b>	 #10-32 1/4 HEX	<b>75 OHM SMC</b>	<b>PLUG</b>	 5/16-32 11/32 HEX	<b>SMP</b>	<b>MALE</b>	 Ø 0.15" [3.7]
	<b>JACK</b>	 #10-32 Ø 0.14 [3.7]		<b>JACK</b>	 5/16-32 Ø 0.24 [6.2]		<b>FEMALE</b>	 Ø 0.13" [3.3]
<b>SSMA</b>	<b>MALE</b>	 #10-36 1/4 HEX	<b>SSMB</b>	<b>PLUG</b>	 Ø 0.18 [4.7]	<b>TNC</b>	<b>MALE</b>	 7/16-28 Ø 0.59 [15.0]
	<b>FEMALE</b>	 #10-36 Ø 0.16 [4.1]		<b>JACK</b>	 Ø 0.10 [2.6]		<b>FEMALE</b>	 7/16-28 Ø 0.38 [9.6]
<b>75 OHM TNC</b>	<b>MALE</b>	 7/16-28 Ø 0.59 [15.0]	<b>REVERSE POLARITY TNC</b>	<b>MALE</b>	 7/16-28 Ø 0.59 [15.0]	<b>UHF</b>	<b>MALE</b>	 5/8-24 Ø 0.70 [17.8]
	<b>FEMALE</b>	 7/16-28 Ø 0.38 [9.6]		<b>FEMALE</b>	 7/16-28 Ø 0.38 [9.6]		<b>FEMALE</b>	 5/8-24 Ø 0.55 [14.0]

\*SMA, 2.92mm & 3.5mm CONNECTORS WILL MATE MECHANICALLY & ELECTRICALLY TO EACH OTHER.



Technical Support  
+1 (949) 261-1920



Same-Day Shipping,  
Even Custom  
Cable Assemblies

# CONNECTOR FREQUENCY RANGE CHART

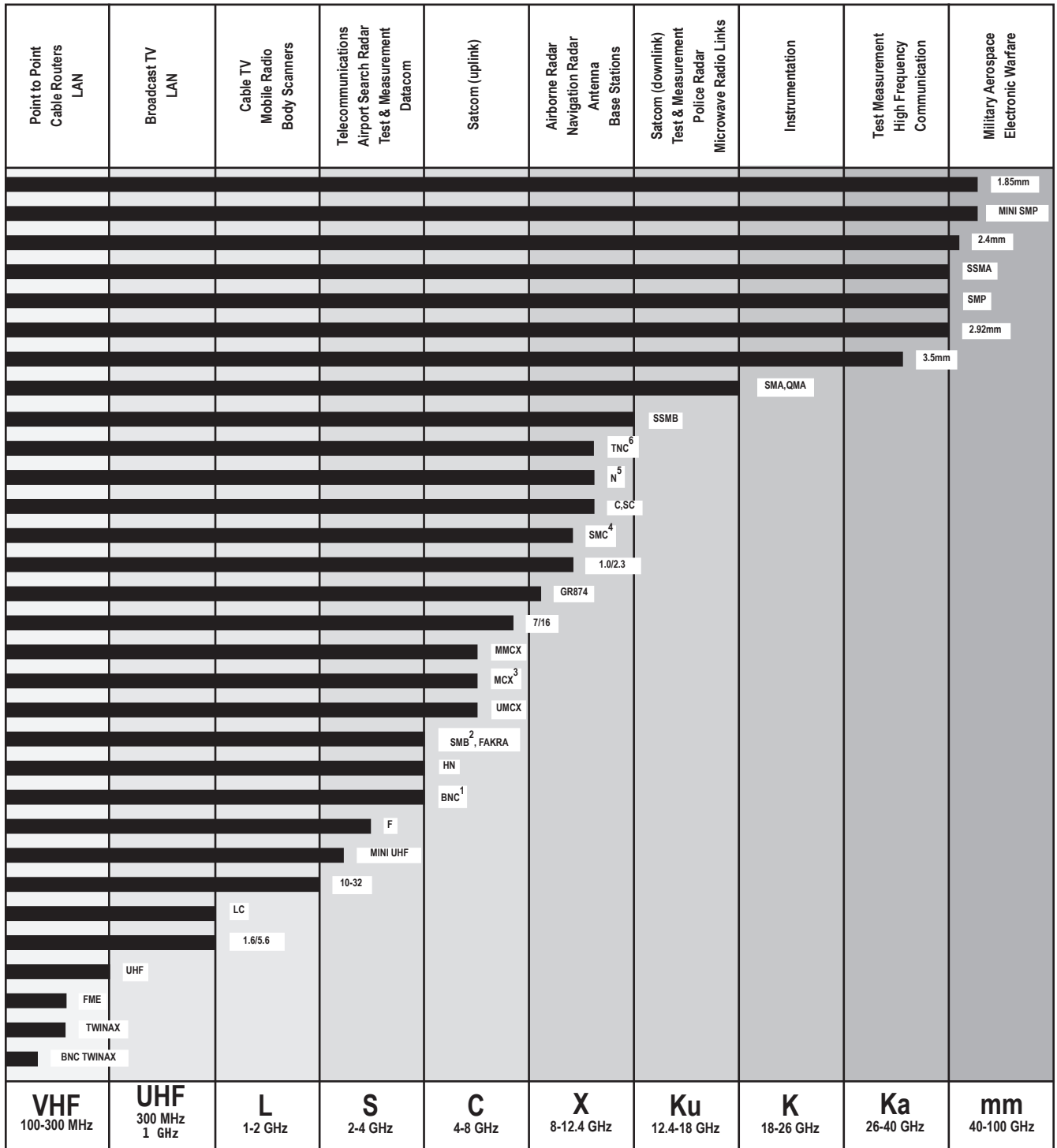

**Notes:**

- 1: BNC-75 Ohm connectors operate up to 1 GHz
- 2: SMB-75 Ohm & Mini SMB-75 Ohm connectors operate up to 4 GHz
- 3: MCX-75 Ohm connectors operate up to 6 GHz
- 4: SMC-75 Ohm connectors operate up to 10 GHz
- 5: N-75 Ohm connectors operate up to 1.5 GHz
- 6: TNC-75 Ohm connectors operate up to 1 GHz



## RF Solutions from RF Engineers

Exclusive Pasternack Distributor:

**MRC GIGACOMP**  
specialists in RF

**MRC GIGACOMP GMBH & CO. KG**

TEL: +49 89 4161 5994 0

FAX: +49 89 4161 5994 5

EMAIL: [info@mrc-gigacomp.com](mailto:info@mrc-gigacomp.com)

WEB: [www.mrc-gigacomp.com](http://www.mrc-gigacomp.com)



Same-Day Shipping  
on orders placed by 4:00 pm PST



24-Hour Support  
by phone, chat or email



Secure Online Ordering  
[pasternack.com](http://pasternack.com)  
[sales@pasternack.com](mailto:sales@pasternack.com)



USA & Canada: 1 (866) 727-8376  
International: +1 (949) 261-1920