

Fixed Coaxial Attenuators



- /// dc to 40 GHz, up to 1,000 Watts
- /// New Conduction Cooled Designs
- /// High reliability
- /// Rugged injection molded connectors
- /// Low Intermodulation (LIM) versions available
- /// Custom connector options

General Information

In this section of the catalog, each Fixed Coaxial Attenuator is outlined utilizing individual data sheets containing product features, specifications, and outline drawings. These data sheets are preceded by a quick reference guide to help you select the Fixed Coaxial Attenuator(s) that fits your needs. The page number for each Fixed Coaxial Attenuator data sheet is given in the quick reference guide.

From the company's very first DC - 1 GHz tee attenuator, came the technology that enabled the design of the first DC - 5 GHz, the first DC - 10 GHz, and the first DC - 18 GHz coaxial attenuators. These designs led to the development of the distributed resistor card attenuator element, which is the basis for most all attenuators manufactured today from DC - 60 GHz. Until the original patents expired a few years ago, most major attenuator manufacturers in the U.S. were licensed under one or more Weinschel Engineering, Co., patents.















Also MIL-DTL-3933 Qualified - Aeroflex / Weinschel is a QPL supplier of Fixed Attenuators. Most Aeroflex / Weinschel Fixed Coaxial Attenuators can be supplied according to customer specified testing, environmental or military or government specification requirements (page 41).

Attenuator Sets of Aeroflex / Weinschel Fixed Attenuators are also available...see page 40.



Low Power Fixed Attenuators...dc-40 GHz, 1-5 Watts





| Model Number | Frequency Range (GHz) | Average Power (Watts) | Peak Power (kW) | Nominal Attenuation Value (dB) | SWR | Connector Type | Page No | |
|----------------|-----------------------|-----------------------|-----------------|--|--------------------------|-------------------|---------|---|
| 1 2 | dc-12.4 dc-18.0 | 5 | 1 | 1-6, 10, 20, 30, 40, 50, 60 | 1.15-1.25* 1.15-1.35* | N | 36 |  |
| 1W | dc-4.0 | 2 | 0.25 | 1-6, 10, 20 | 1.25 | N | 34 |  |
| 3T 4T | dc-12.4 dc-18.0 | 2 | 0.50 | 1-6, 10-12, 20, 30, 40, 50, 60 1-6, 10-12, 20, 30 | 1.15-1.25* | SMA 1.15-1.35* | 26 |  |
| 3M 4M | dc-12.4 dc-18.0 | 2 | 0.50 | 1-10, 20, 30, 40, 50, 60 | 1.15-1.25* 1.15-1.35* | SMA | 27 |  |
| 4H | dc-18.6 | 2 | 0.25 | 0-10, 12, 15, 20, 30 | 1.15-1.35* | SMA | 29 |  |
| 87 | dc-32.0 | 2 | 0.50 | 0-30 in 0.5 dB Increments | 1.25 | SMK (2.92mm) | 31 |  |
| 44 | dc-18.0 | 5 | 1 | 1-10, 20, 30, 40, 50, 60 | 1.15-1.25* | N | 37 |  |
| 54A | dc-40.0 | 2 | 0.5 | 3, 6, 10, 20, 30 | 1.25-1.40* | SMK (2.92mm) | 33 |  |
| 55 | dc-18.0 | 5 | 1 | 3, 6, 10, 20, 30 | 1.15-1.35* | TNC | 35 |  |
| 56 | dc-28.0 | 2 | 0.5 | 0-10, 20, 30 | 1.10-1.25* | 3.5mm | 30 |  |
| 69A | dc-18.0 | 5 | 0.5 | 1-10, 20, 30 | 1.15-1.35* | SMA | 38 |  |
| 75A | dc-40.0 | 5 | 0.2 | 3, 6, 10, 20, 30 | 1.20-1.35* | SMK (2.92mm) | 39 |  |
| 84A | dc-40.0 | 2 | 0.5 | 3, 6, 10, 20, 30 | 1.35-150* | 2.4mm | 32 |  |
| 3330A 3331A | dc-18.0 | 2 | 0.25 | 1-10, 20, 30 | 1.15-1.40* | SMA | 28 |  |

* VARIES WITH FREQUENCY.

Hi-Reliability & Space Fixed Attenuators...dc-40 GHz, 2 Watts



| Model Number | Frequency Range (GHz) | Average Power (Watts) | Peak Power (kW) | Nominal Attenuation Value (dB) | SWR | Connector Type | Page No | |
|---------------------|-----------------------|-----------------------|-----------------|--------------------------------|------------|-----------------|---------|---|
| 32 | dc-18.0 | 2 | 0.50 | 0-20 in 0.5 dB Increments | 1.15-1.35* | SMA | 42 |  |
| 32J | dc-32.0 | 2 | 0.50 | 0-30 in 0.5 dB Increments | 1.25 | SMK (2.92mm) | 43 |  |
| 32K <i>(NEW)</i> | dc-40.0 | 2 | 0.50 | 3, 6, 10, 20, 30 | 1.25-1.45* | SMK (2.92mm) | 44 |  |











* VARIES WITH FREQUENCY.

Fixed Coaxial Attenuators



Medium Power Fixed Attenuators...dc-40 GHz, 10-50 Watts



















| Model Number | Frequency Range (GHz) | Average Power (Watts) | Peak Power (kW) | Nominal Attenuation Value (dB) | SWR | Connector Type | Page No | |
|--------------|-----------------------|-----------------------|-----------------|--------------------------------|------------|------------------|---------|---|
| 23 | dc-18.0 | 10 | 1 | 3, 6, 10, 20, 30, 40, 50, 60 | 1.15-1.35* | N | 47 |  |
| 37 | dc-8.5 | 10 | 1 | 3, 6, 10, 20, 30 | 1.15-1.25* | N | 46 | |
| 24 | dc-8.5 | 50 | 5 | 3, 6, 10, 20, 30 | 1.20-1.30* | SMK (2.92mm) / N | 55 |  |
| 33 | dc-8.5 | 25 | 5 | 3, 6, 10, 20, 30 | 1.20-1.30* | SMK (2.92mm) / N | 51 |  |
| 34 | dc-4.0 | 25 | 5 | 3, 6, 10, 20, 30 | 1.10-1.20* | / N | 49 | |
| 41 | dc-18.0 | 10 | 1 | 1, 2, 3, 6, 10, 20, 30 | 1.20-1.35* | SMA | 45 |  |
| 46 | dc-18.0 | 25 | 1 | 3, 6, 10, 20, 30, 40 | 1.20-1.35* | 3.5mm / N | 52 |  |
| 47 | dc-18.0 | 50 | 1 | 3, 6, 10, 20, 30, 40 | 1.20-1.45* | 3.5mm / N | 57 |  |
| 74 | dc-28 | 25 | 0.5 | 3, 6, 10, 20, 30 | 1.30-1.35* | 3.5mm | 53 |  |
| 77 | dc-18.0 | 25 | 1 | 3, 6, 10, 20, 30, 40 | 1.20-1.35* | 7/16 | 50 |  |
| 89 | dc-40.0 | 20 | 0.2 | 10, 20, 30 | 1.25-1.40* | SMK (2.92mm) | 48 |  |
| 90 | dc-18.0 | 50 | 1 | 3, 6, 10, 20, 30 | 1.15-1.30 | 3.5mm / N | 56 |  |

* VARIES WITH FREQUENCY.

High Power Fixed Attenuators...dc-18.0 GHz, 100-1000 Watts



| Model Number | Frequency Range (GHz) | Average Power (Watts) | Peak Power (kW) | Nominal Attenuation Value (dB) | SWR | Connector Type | Page No. | |
|-------------------|-----------------------|-----------------------|-----------------|---|--------------------|------------------|----------|---|
| 40 57 | dc-1.5 dc-6.0 | 150 150 | 10 10 | 3, 6, 10, 20, 30, 40 6, 10, 20, 30, 40 | 1.10 1.20 | N N | 62 |  |
| 45 58 | dc-1.5 dc-6.0 | 250 250 | 10 10 | 3, 6, 10, 20, 30, 40 6, 10, 20, 30, 40 | 1.10 1.15-1.20* | N | 68 |  |
| 48 | dc-18.0 | 100 | 1 | 6, 10, 20, 30, 40 | 1.25-1.55* | 3.5mm / N | 61 |  |
| 49 | dc-8.5 | 150 | 5 | 3, 6, 10, 20, 30, 40 | 1.25-1.35* | SMK (2.92mm) / N | 65 |  |
| 53 | dc-2.5 | 500 | 10 | 3, 6, 10, 20, 30, 40 | 1.10 | N | 70 |  |
| 65 | dc-2.5 | 150 | 10 | 3, 6, 10, 20, 30 | 1.20 | N | 63 |  |
| 66 | dc-18.0 | 150 | 1 | 10, 20, 30, 40 | 1.90 | 3.5mm / N | 66 |  |
| 67 | dc-12.7 | 350 | 5 | 10, 20, 30 | 1.30-1.60* | N | 69 |  |
| 68 | dc-4.0 | 100 | 10 | 1, 2, 3, 6, 10, 20, 30, 40 | 1.20 | SMK (2.92mm) / N | 58 |  |
| 73 | dc-8.5 | 100 | 5 | 3, 6, 10, 20, 30, 40 | 1.25-1.35* | SMK (2.92mm) / N | 59 |  |
| 78 | dc-6.0 | 150 | 1 | 10, 20, 30, 40 | 1.90 | 7/16 | 54 |  |
| 79 | dc-6.0 | 150 | 10 | 6, 10, 20, 30, 40 | 1.20 | 7/16 | 64 |  |
| 81 | dc-10.0 | 500 | 5 | 10, 20, 30, 40 | 1.65-1.90* | N | 71 |  |
| 82 | dc-3.0 | 1,000 | 10 | 10, 20, 30, 40 | 1.15-1.25* | N | 72 |  |
| 251 <i>NEW</i> | dc-6.0 | 200 | 10 | 10, 20, 30, 40 | 1.10-1.20 | SMK (2.92mm) / N | 67 |  |
| 260 <i>NEW</i> | dc-18.0 | 100 | 1 | 3, 6, 10, 20, 30 | 1.15-1.30 | 3.5mm / N | 60 |  |

* VARIES WITH FREQUENCY.

Fixed Coaxial Attenuators



Low IMD Fixed Attenuators...dc-18.0 GHz, 25-550 Watts











| Model Number | Frequency Range (GHz) | Average Power (Watts) | Peak Power (kW) | Nominal Attenuation Value (dB) | SWR | Connector Type | Page No | |
|-----------------------------|-----------------------|-----------------------|-----------------|--------------------------------|------------|------------------|---------|--|
| 24-XX-XX-LIM | dc-8.5 | 50 | 5 | 3, 6, 10, 20, 30 | 1.20-1.30* | SMK (2.92mm) / N | 55 | |
| 33-XX-XX-LIM | dc-8.5 | 25 | 5 | 10, 20, 30, 40 | 1.20-1.30* | SMK (2.92mm) / N | 51 | |
| 46-XX-XX-LIM | dc-18.0 | 25 | 1 | 10, 20, 30, 40 | 1.20-1.35* | 3.5mm / N | 52 | |
| 47-XX-XX-LIM | dc-18.0 | 50 | 1 | 10, 20, 30, 40 | 1.20-1.45* | 3.5mm / N | 57 | |
| 48-XX-XX-LIM | dc-18.0 | 100 | 1 | 10, 20, 30, 40 | 1.25-1.55* | 3.5mm / N | 61 | |
| 57-XX-XX-LIM | dc-6.0 | 150 | 10 | 10, 20, 30, 40 | 1.20 | N | 62 | |
| 58-XX-XX-LIM | dc-6.0 | 250 | 10 | 10, 20, 30, 40 | 1.20-1.25* | N | 68 | |
| 49-XX-XX-LIM | dc-8.5 | 150 | 5 | 10, 20, 30, 40 | 1.25-1.35* | N | 65 | |
| 53-XX-XX-LIM | dc-2.5 | 500 | 10 | 10, 20, 30, 40 | 1.10 | N | 70 | |
| 77-XX-XX | dc-18.0 | 50 | 1 | 3, 6, 10, 20, 30, 40 | 1.20-1.35* | 7/16 | 50 | |
| 78-XX-XX | dc-18.0 | 150 | 1 | 10, 20, 30, 40 | 1.90 | 7/16 | 54 | |
| 79-XX-XX | dc-6.0 | 150 | 10 | 10, 20, 30, 40 | 1.20 | 7/16 | 64 | |
| 90-XX-XX-LIM <i>NEW</i> | dc-18.0 | 50 | 1 | 3, 6, 10, 20, 30 | 1.15-1.30 | 3.5mm / N | 56 | |
| 253-XX-XX-LIM <i>NEW</i> | dc-6.0 | 550 | 10 | 10, 20, 30, 40 | 1.10-1.20* | SMK (2.92mm) / N | 80 | |
| 257-XX-XX-LIM <i>NEW</i> | dc-6.0 | 250 | 10 | 10, 20, 30, 40 | 1.10 | SMK (2.92mm) / N | 78 | |
| 258-XX-XX-LIM <i>NEW</i> | dc-6.0 | 250 | 10 | 10, 20, 30, 40 | 1.10-1.25 | SMK (2.92mm) / N | 79 | |
| 260-XX-XX-LIM <i>NEW</i> | dc-18.0 | 100 | 1 | 3, 6, 10, 20, 30 | 1.15-1.30 | 3.5mm / N | 60 | |
| 268-XX-XX-LIM | dc-6.0 | 100 | 10 | 10, 20, 30, 40 | 1.10-1.15* | SMK (2.92mm) / N | 77 | |

* VARIES WITH FREQUENCY.

Conduction Cooled...dc-40 GHz, 5-550 Watts



| Model Number | Frequency Range (GHz) | Average Power (Watts) | Peak Power (kW) | Nominal Attenuation Value (dB) | SWR | Connector Type | Page No | |
|-------------------|-----------------------|-----------------------|-----------------|--------------------------------|------------|------------------|---------|--|
| 59 | dc-2.5 | 100 | 10 | 3, 6, 10, 20, 30, 40 | 1.15 | SMK (2.92mm) / N | 76 |  |
| 72 | dc-4.0 | 50 | 1 | 3, 6, 10, 20, 30, 40 | 1.20 | SMK (2.92mm) / N | 74 |  |
| 86 | dc-22.0 | 50 | 1 | 3, 6, 10, 20, 30 | 1.30 | 3.5mm | 75 |  |
| 253 <i>NEW</i> | dc-6.0 | 550 | 10 | 10, 20, 30, 40 | 1.10-1.20* | SMK (2.92mm) / N | 80 |  |
| 257 <i>NEW</i> | dc-6.0 | 250 | 10 | 10, 20, 30, 40 | 1.10 | SMK (2.92mm) / N | 78 |  |
| 258 <i>NEW</i> | dc-6.0 | 400 | 10 | 10, 20, 30, 40 | 1.10-1.25* | SMK (2.92mm) / N | 79 |  |
| 268 <i>NEW</i> | dc-6.0 | 100 | 10 | 6, 10, 20, 30, 40 | 1.10-1.15* | SMK (2.92mm) / N | 77 |  |
| 275 <i>NEW</i> | dc-40.0 | 5 | 1 | 6, 10, 20, 30 | 1.25-1.45* | SMK (2.92mm) | 73 |  |

* VARIES WITH FREQUENCY.

Fixed Coaxial Attenuators



Frequently Asked Questions about Fixed Coaxial Attenuators....

What are the advantages of Weinschel's fixed attenuators?

Aeroflex / Weinschel low power fixed attenuators feature a combination of advantages over other designs:*

1. Most Aeroflex / Weinschel attenuators feature injection molded dielectric for better center pin captivation and alignment. Injection molded dielectric also eliminates the need for the epoxy hole "stake" as seen in other designs. This epoxy hole in other designs is subject to RF leakage and movement when exposed to environmental extremes and prolonged use.
2. Aeroflex / Weinschel fixed attenuators have a proprietary resistor element, fired at 950°C for superior long term stability over temperature, power and time. The attenuator element is trimmed for precise custom attenuation values.
3. Aeroflex / Weinschel fixed attenuators have no solder contacts. They feature spring loaded plunger contacts to the resistor cards that provide expansion tolerance over wide temperature and power ranges.
4. Aeroflex / Weinschel fixed attenuators are made with high quality materials and machined to very close tolerances. The result is a design that stands up to severe environmental and multiple matings.
5. High power designs feature special high temperature dielectric support beads.

Does Aeroflex / Weinschel offer high reliability fixed attenuators?



Yes, most Most Aeroflex / Weinschel Fixed Coaxial Attenuators can be supplied according to customer specified testing, environmental or military or government specification requirements.

Hi-Rel units can be laser-marked and are manufactured from materials which have a TML of less than 1% and CVCM less than 0.1%.

What is a bidirectional and unidirectional attenuator?

All Aeroflex / Weinschel attenuators are bidirectional unless they are specified as unidirectional in the power rating specification. Bidirectional means the maximum specified power can be applied to either the input or output of the attenuator. Unidirectional means the maximum specified power can only be applied to the input port of the attenuator. Unidirectional designs allow for smaller overall package sizes and reduced costs. All our attenuators have maximum average and peak pulse input power limits. The average power limit decreases linearly as the ambient temperature increases. If these limits are exceeded, burnout of the attenuator element results or its calibration may be permanently changed. When used within its specifications, an attenuator is an indispensable component in measurement and system applications.

*Most designs, some features may not apply to certain low cost attenuator designs.

What dB values are available besides those in the catalog?

Most any dB value is available; however you should consult your local sales representative or the factory for design availability for a particular dB value for the selected model. There is generally an additional charge for non-catalog values.

Can Aeroflex / Weinschel provide attenuators for space applications?

Yes. Aeroflex / Weinschel fixed attenuators are being used on a wide variety of military and commercial communication satellites. "S" level fixed attenuators can be provided for any dB value up to 40 dB from dc to 52 GHz. Aeroflex / Weinschel has recently introduced Models 32K (page 30) and 32L (page 31) standard fixed attenuators that operates from dc to 42 or 52 GHz. These attenuators offer superior electrical and mechanical design that is ideally suited for space applications.

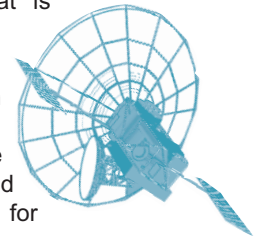

Aeroflex / Weinschel's use of precision connectors, injection molded captivation of connector contacts (no solder or contact fingers) and very precise and stable resistors result in a superior electrical and mechanical design that is ideally suited for space applications.

Aeroflex / Weinschel program experience includes:

| | | |
|---------------------|------------|-------|
| Aussat (Optus) | SSTI | JCSAT |
| KOREASAT | GlobalStar | GEM |
| TDRSS | ICO | SMTS |
| TELSTAR | INTELSAT | AGILA |
| GOES | ACeS | MSAT |
| MILSTAR | EOS | TOMS |
| ...and many others. | | |

Aeroflex / Weinschel offers extensive testing programs for space qualified attenuators and other components that can include:

Random Vibration: Random and/or Sine Vibration up to 100 g rms.

Monitored Thermal Cycle: Units monitored for open condition over -55 °C to +100 °C, 15 cycleS.

Thermal Shock: Performed per MIL-STD-202G, Method 107.

Burn-In Testing: Performed at rated power and operating temperature from 96 to 360 hours typical.

Mechanical Shock: Performed per MIL-STD-202, Method 213 Test Condition F up to 1000 G peak.

Moisture Resistance Testing: Performed per MIL-STD-202, Method 106. (except sub-cycle 7b is not applicable) with connectors capped.

Salt Spray: Performed per MIL-STD-202, Method 101 with connectors capped.



Can Weinschel provide special fixed attenuators?

Yes. Aeroflex / Weinschel has produced over 2000 custom fixed attenuator designs. Specials continue to be a significant part of Weinschel's product offering. Special features may include:

1. Custom Connector Configurations
2. Matched Pairs or Sets
3. Lower VSWR & Higher Accuracy
4. Special Mounting & Environmental Conditions
5. Unique Test Requirements & Data

Does Weinschel offer any attenuators with IM3 specified?

Yes Aeroflex / Weinschel has recently introduced new as well as updated models specifically for applications requiring low intermodulation distortion. Models are available with the low IM options are...24, 33, 40, 45, 46, 47, 48, 48, 53, 57, & 58. Refer to the page 15 for a product line overview or the specific data sheet for IM3 details.

How is the temperature or power coefficient specification applied?

These specifications tell how much the attenuation will change when the ambient temperature or input power changes. First multiply the catalog temperature coefficient or power coefficient by the ambient temperature range or input power range to which the attenuator will be exposed. Then multiply that number by the dB value of the attenuator. The result is the maximum change in attenuation than can be expected over the ambient temperature range or power range that was specified.

How is the attenuator power rating calculated?

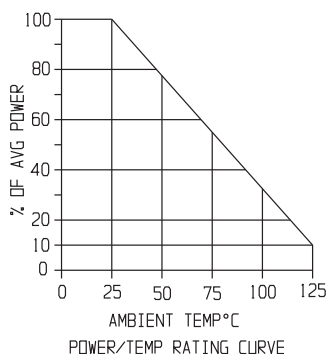

An attenuator will handle specified power at ambient temperatures as specified in the catalog. No special fan cooling is required. At higher temperatures the power rating is calculated by using catalog specifications and a straight line graph (Example shown above). For instance the power rating of the Model 48 attenuator is 100 watts to 25°C and 10 watts at

125°C. Using linear graph paper, plot a straight line between these two points. This plot shows that the power rating at 75°C is approximately 56 Watts.

Does Aeroflex / Weinschel offer attenuators sets or attenuation test kits?

Aeroflex / Weinschel offers a variety of attenuation standard sets consisting of precision designed fixed attenuators. These sets are ideally suited for standards and research laboratories as well as production, quality control, and inspection departments. Aeroflex / Weinschel attenuation sets are available in either 3, 6, 10, 20 dB or 1, 3, 6, 10, 20,

30 dB attenuation values. Each attenuator is tested in 1 GHz intervals to minimize interpolation error. The attenuator sets are available in stainless steel type N (Model 1 & 44), and 3.5mm (Model 56) connectors. Custom sets with other connector type and higher power sets are also available upon request. Refer to page 66 for more details.

What is Third-Order Intermodulation Distortion?

(IM3) Intermodulation distortion (IM) consists of the spurious signals which result from the mixing of nth order frequencies in the non-linear elements of a component. Third order intermodulation distortion is of particular interest because third order products typically represent the highest level distortion appearing close to the desired signal, and as such the highest level non-filterable distortion. Third order IM level (IM3) is tested by injecting two pure tones of equal magnitude (f1 and f2) into the component to be tested. The third order IM products will appear in the output spectrum at the frequencies 2f1-f2 and 2f2-f1. These products are characterized by defining their level (in dBc) relative to the fundamental output tones at either f1 or f2.

Applications...

Aeroflex / Weinschel Attenuators are used in a wide variety of applications in the electronic field for the control or measurement of radio frequency energy. Attenuators are used as accurate standards in the measurement of loss or gain by the RF substitution method. They are used as a means of extending the dynamic range of measuring equipment such as power meters, field intensity meters, spectrum analyzers, and amplifiers, or to prevent overloading of receivers and amplifiers. They also reduce, by masking, the effects of variable or mismatched impedances on such circuit elements as oscillator, T-junctions, mixers, etc.

Fixed Attenuators can satisfy almost any requirement involving a reduction in power. Attenuators designed and manufactured by Aeroflex / Weinschel are very stable and remain precision calibrated over wide ranges of humidity, temperature, and other ambient conditions for long periods of time.



Fixed Coaxial Attenuators

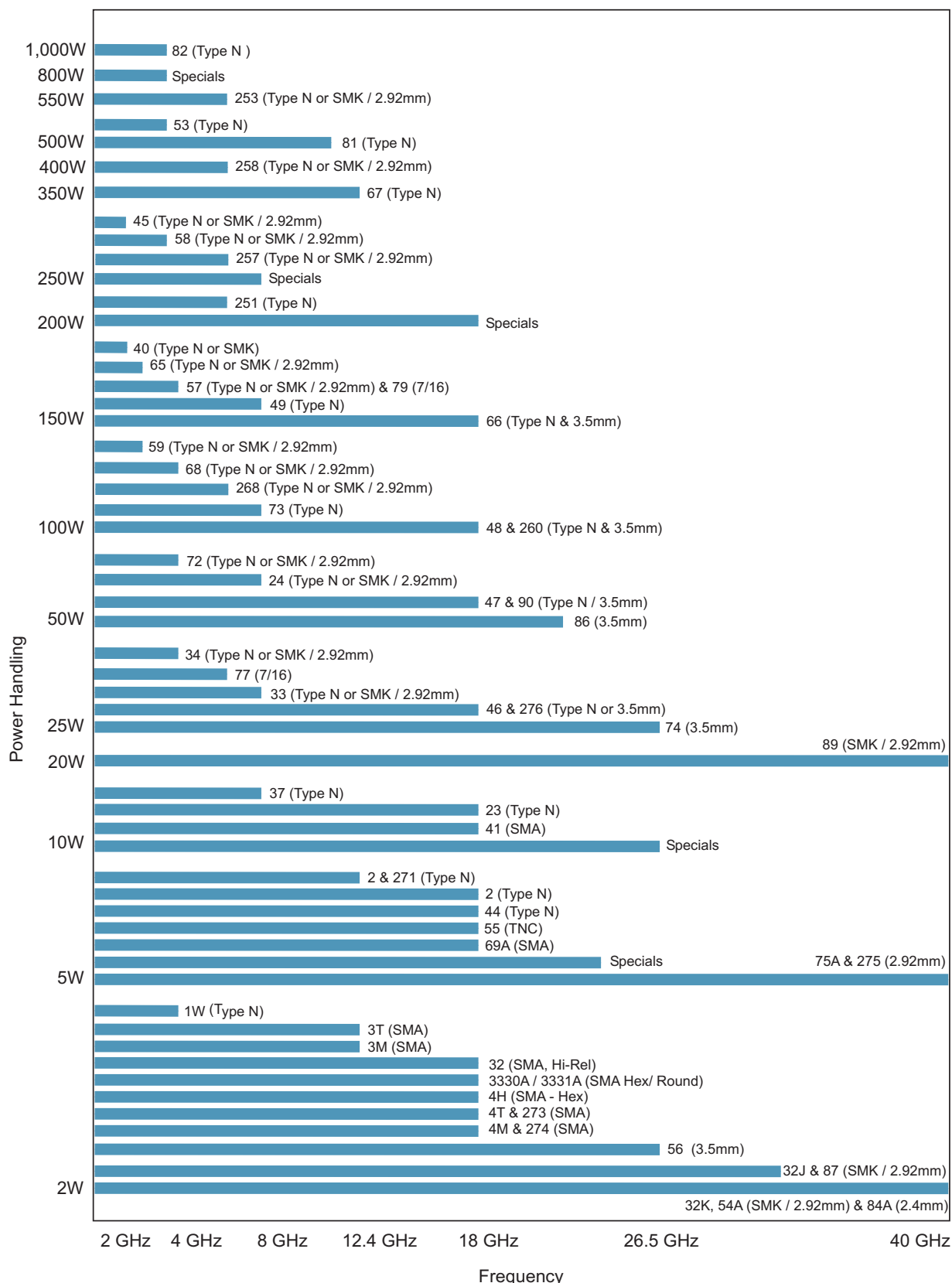

Attenuation Selection Guide: Power Handling / Frequency / Connector Type

Understanding Temperature & Power Coefficient in Attenuators

By the Components Engineering Staff @ Aeroflex / Weinschel
 Article written By Jimmy Dholoo, VP Engineering & Rob Sinno, Design Engineer

Temperature Coefficient of Resistance, TCR, is a well-known parameter in the Electronics Industry. Power Coefficient of Resistance, PCR, is not such a familiar term. Manufacturers seldom provide PCR specifications for their resistors. TCR and PCR are usually expressed in parts per million per degree (ppm / °C), or parts per million per watt (ppm / W). Applying PCR in an example, a 10-Watt, 100-ohm resistor with a PCR of +/- 200ppm/W could change by +/- 0.2 ohms when subjected to 10 Watts of average power at ambient temperature (100Ωx10Wx200x10⁻⁶ /W).

Attenuators in their discrete form are usually a combination of chip resistors in a Pi or T network, and the type of resistors selected for such networks depends on the desired frequency, temperature and power handling requirements. The individual chips in such a network might either be thin- or thick-film resistors. For higher frequency applications, attenuators usually take on a distributed form, with a resistive sheet of thick-film or thin-film terminated with suitable metalization, Figure 1. The most common material for thick-film resistors is ruthenium dioxide. Popular thin film materials are nichrome, tantalum nitride and tin oxide.

a - Pi Network:

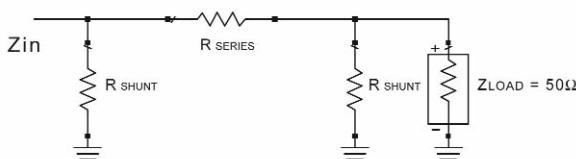

b - T Network:

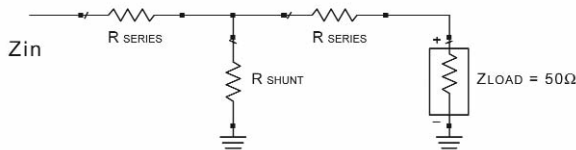

c - Distributed Attenuator

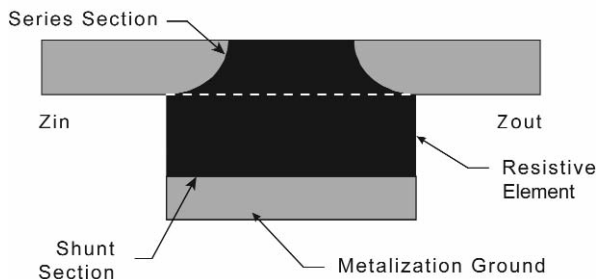

Figure 1.

Almost all the fixed and programmable attenuators offered by Weinschel specify a Temperature Coefficient of Attenuation (TCA) and a Power Coefficient of Attenuation (PCA) in the product data sheets. Based on the inquiries we receive about the interpretation of these specifications, it seems that some basic explanation is necessary so the end user can correctly forecast the worst case scenario for his system; i.e. what attenuation change might be expected at temperature and power extremes.

Case 1: TCA of Fixed Attenuators

All of Weinschel's fixed attenuators are of the distributed type and of a proprietary thin-film Tin Oxide composition. The tin oxide is deposited on a ceramic substrate at 930°C via a chemical vapor deposition process and terminated with gold metalization. Depending on the product type, the substrate could be Alumina, BeO or ALN. The vast fixed attenuator family covers a frequency range of DC to 40 GHz, and the power handling ranges from as low as 2 watts to 1000 watts. The TCA for every fixed product is specified as 0.0004dB/dB/°C because the predominant factor determining the TCA is the TCR of the tin oxide film. The substrate material, the sheet resistivity and the mechanical contacts between the connectors and the substrate and between the substrate and the grounds do contribute to the overall TCA, but to a much lesser extent. The TCA is usually measured at a power level low enough so as not to cause any significant warming of the unit. Attenuation is measured at various ambient temperatures over a specified frequency range. The worst-case coefficient arrived at is based on the maximum attenuation change over the frequency band. Military Standard, MIL-A-3993 for fixed attenuators calls for a TCA of 0.0004dB/dB/°C. Over a 100°C ambient temperature change, a 30 dB attenuator would change by a maximum of 1.2 dB at low signal levels. In reality, the TCA of Weinschel attenuators is 0.0001dB/dB/°C. The maximum change would only be 0.3 dB on a 30 dB attenuator, thus providing a significant guard band to the user.

Figure 2 is a theoretical plot showing the attenuation variation on a 10 dB distributed attenuator as a function of the TCR of the resistive thin-film at two temperature extremes, -75°C and +125°C. It is interesting to note that the change in attenuation is rather small over such a wide swing of both temperature and TCR. Figure 3 is a similar plot of the impedance variation of the same attenuator and this shows a significant change from the nominal 50-ohm impedance. Three obvious conclusions can be drawn from these plots:

- As long as the shunt and series resistive elements of an attenuator have the same TCR the attenuation will always increase at DC, independent of the temperature and the magnitude of the TCR. Distributed film attenuators will always behave in this manner because the shunt and series sections are formed from the same resistive film and therefore have the same TCR. Discrete attenuator networks may not behave in this

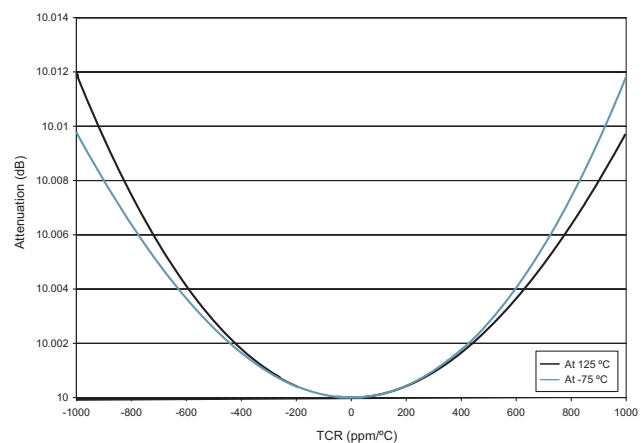

Figure 2. Attenuation as a Function of TCR for Two Temperature Extremes, 25 ± 100 °C.

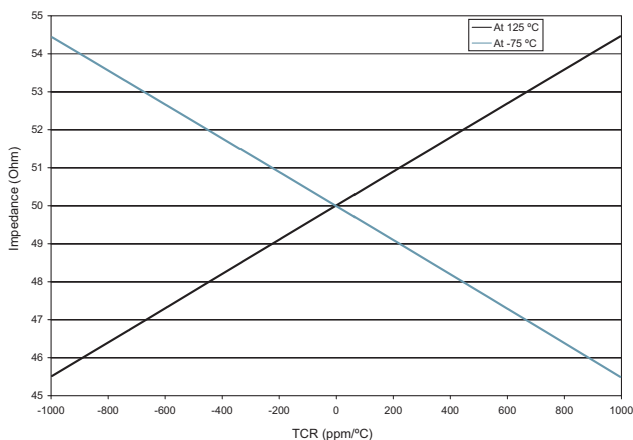

Figure 3. Impedance as a Function of TCR for Two Temperature Extremes, 25 ± 100 °C.

manner because the discrete shunt and series chip resistors may have different TCRs.

- Since an increase in the resistance of the series element increases the attenuation and an increase in the resistance of the shunt element reduces the attenuation the overall change in the attenuation is very small and far less than the change in the individual resistors.
- Materials with poor TCR figures will seriously impact the impedance of distributed attenuators and significantly degrade the SWR, with little effect on the DC attenuation.

Case 2: PCA of Fixed Attenuators

Though the specified TCA of all attenuators is the same, the PCA varies across the product line since it is no longer just a function of the tin oxide resistive film. It also depends on the substrate material, metalization, packaging, heat sinking and forced cooling, if any. The effect of high power/high voltage on this resistive film is quite different from that of a temperature increase at low voltages/low power. A detailed discussion of this is beyond the scope of this article but it is important to note that this effect is a function of the electrical stress in the film and will depend on the dimensions of the resistive film, and so is a function of the size and shape of the resistor. Also, it is worth clarifying that referring to this high voltage effect as a "Power Coefficient!" is misleading since the rate of change of resistance with applied voltage is not constant and the film exhibits some degree, albeit small, of non-linearity.

From the Weinschel fixed attenuator product line, a typical 2 W attenuator has a PCA of < 0.005 dB/dB/W, so a 30 dB unit would change by less than 0.3 dB (across the full frequency band, when the incident power increases from, say, 10mW to 2 Watts. Similarly, a 500W unit with a PCA of 0.0001dB/dB/W would change by less than 1.5dB (over its operating frequency band when the incident power increases from a low level signal to the full 500 watts.

PCA measurements are not easily made. Just as the TCA is measured at a constant low power level with varying ambient temperatures, the PCA must be measured at a constant ambient temperature of 25°C with varying power and over the entire operating frequency range. To carry out such measurements with good accuracy requires a set of high-power, broadband bias tees and good matching techniques. The test set-up is shown in the MIL- A-3933 document.

Case 3: TCA of switched Programmable Attenuators

Switched Programmable attenuators typically comprise several attenuator "cells", usually in a binary sequence: 1 dB, 2 dB, 4 dB, 8 dB, 16 dB, 32 dB etc, Fig 4. These cells are selectively switched ON from their `zero' state, using DPDT relays for electromechanical models and PIN diodes, for solid state versions. Programmable attenuators basically have two states, a zero state when the unit is sitting in its minimum insertion loss position and an attenuate state when the unit is sitting in any of the selected attenuation positions. The interpretation of TCA for these products has at times raised questions because there are two TCA figures associated with them. The first is the Absolute TCA, which is derived from the total change in any selected attenuation, between two temperatures at low signal levels. The second is the relative or Incremental TCA. Programmable attenuators are frequently installed in systems and instruments to accurately control RF signal levels. Their insertion loss in the ZERO attenuation position usually becomes part of the overall system loss and is zeroed out in the normalization process. What is important in such cases is the accuracy of the incremental attenuation with reference to the normalized state and, therefore, it is the Incremental TCA that is more relevant to the designer/user. Incremental TCA is derived from the change in the incremental attenuation state at two temperatures; i.e., the normalization of the zero is carried out at both temperatures.

The blue plot in Figure 4 shows the change in the zero state attenuation of an 8 cell electromechanical unit. It was generated by first normalizing its zero state loss at room temperature and then raising the ambient to 100°C. The major attenuation change over temperature comes from the 8 relays. Typically a 75-degree change causes a 0.5 dB change in the Zero insertion loss (0.063 dB per relay). For this unit, if normalization were carried out at 25°C, the 1 dB cell switched ON and the ambient raised to 100°C, the 1 dB cell would read 1.5 dB at around 1.5 GHz. This would yield the worst-case Absolute TCA of 0.0066 dB/dB/°C (0.5dB /1dB/75°C). As a comparison, the red plot in Figure 4 shows that the Incremental attenuation change of the 32 dB is only 0.05 dB at about 2 GHz because we measure it at 25°C with one normalization and again at 100°C with another normalization. So all changes due to the relays are masked and the worst-case Incremental TCA works out to be 0.000021 dB/dB/°C (0.05dB/32dB/75°C). This shows that the ruthenium based thick-film attenuators screened on a ceramic substrate hardly change over this temperature range. Almost all the temperature variance is therefore attributable to the relay contacts.

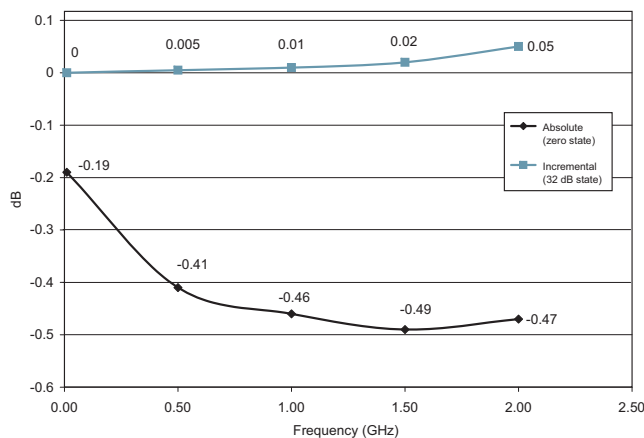

Figure 4 -- 8 Cell Relay Based Programmable Attenuator: Change in the Absolute & Incremental Attenuation from 25°C and 100°C

Model 3T Model 4T Ruggedized SMA Connectors

dc to 12.4 GHz
dc to 18.0 GHz
2 Watts

RoHS



Features

- /// Rugged injection molded connectors.
- /// Designed to meet environmental requirements of MIL-DTL-3933.
- /// Small Package Size
- /// Usable to 22 GHz.

Specifications

NOMINAL IMPEDANCE: 50 Ω

FREQUENCY RANGE: Model 3T: dc to 12.4 GHz
Model 4T: dc to 18.0 GHz

MAXIMUM DEVIATION OVER FREQUENCY:

| Nominal ATTN (dB) | 3T | 4T |
|-------------------|--------|--------|
| 1 - 6 | ± 0.30 | ± 0.30 |
| 7 - 12 | ± 0.30 | ± 0.50 |
| 20 | ± 0.50 | ± 0.70 |
| 30, 40 | ± 0.75 | ± 1.00 |
| 50, 60 | ± 1.00 | ± 1.50 |

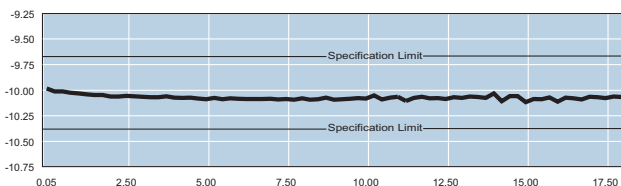

Typical Attenuation Performance of 4T-10

MAXIMUM SWR:

| Frequency (GHz) | 3T | 4T |
|-----------------|------|------|
| dc - 4 | 1.15 | 1.15 |
| 4 - 8 | 1.20 | 1.20 |
| 8 - 12.4 | 1.25 | 1.25 |
| 12.4 - 18 | --- | 1.35 |

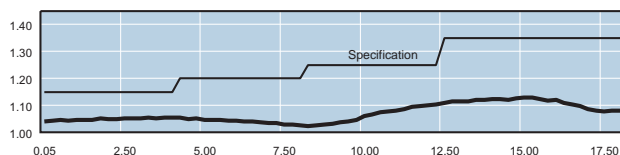

Typical SWR of a Model 4T-10

POWER RATING: 2 watts **average** to 25°C ambient temperature, derated linearly to 0.5 watts at 125°C. 500 watts **peak** (5 μsec pulse width; 0.2% duty cycle).

POWER COEFFICIENT: < 0.005 dB/dB/watts

TEMPERATURE COEFFICIENT: < 0.0004 dB/dB/°C

TEMPERATURE RANGE: -55°C to +125°C

TEST DATA: Swept data plots of attenuation and SWR from 50 MHz to 12.4 / 18 GHz is available at additional cost.

CONNECTORS: SMA connectors per MIL-STD-348 interface dimensions - mate nondestructively with MIL-C-39012 connectors.

CONSTRUCTION: Passivated stainless steel body and connectors; gold plated beryllium copper contacts.

WEIGHT (Both Models):

| dB VALUE | WEIGHT (Net) |
|------------|-----------------|
| 1 - 12 | 3.9 g (0.14 oz) |
| 20 | 4.3 g (0.15 oz) |
| 30 | 4.9 g (0.17 oz) |
| 40, 50, 60 | 6.5 g (0.23 oz) |

PHYSICAL DIMENSIONS:

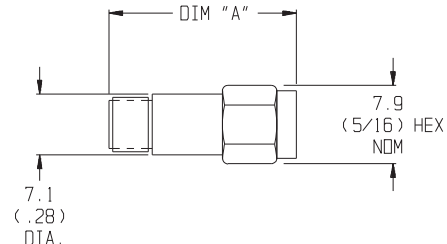

| dB VALUE | DIM A ± 0.5 (0.02) |
|------------|--------------------|
| 1 -12 | 21.8 (0.86) |
| 20 | 23.9 (0.94) |
| 30 | 26.5 (1.04) |
| 40, 50, 60 | 34.0 (1.33) |

NOTE: All dimensions are given in mm (inches) and are maximum, unless otherwise specified.

MODEL NUMBER DESCRIPTION:

Example:

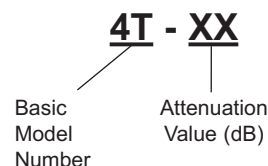

Fixed Coaxial Attenuators



Model 3M Model 4M Ruggedized SMA Connectors

dc to 12.4 GHz
dc to 18.0 GHz
2 Watts



Features

- /// Rugged injection molded connectors.
- /// Designed to meet environmental requirements of MIL-DTL-3933.
- /// Usable to 22 GHz.

Specifications

NOMINAL IMPEDANCE: 50 Ω

FREQUENCY RANGE: Model 3M: dc to 12.4 GHz
Model 4M: dc to 18.0 GHz

MAXIMUM DEVIATION OVER FREQUENCY:

| Nominal ATTN (dB) | 3M | 4M |
|-------------------|--------|--------|
| 1 - 2 | ± 0.30 | ± 0.50 |
| 3 - 6 | ± 0.30 | ± 0.30 |
| 7 - 10 | ± 0.30 | ± 0.50 |
| 20 | ± 0.50 | ± 0.70 |
| 30, 40 | ± 0.75 | ± 1.00 |
| 50, 60 | ± 1.00 | ± 2.00 |

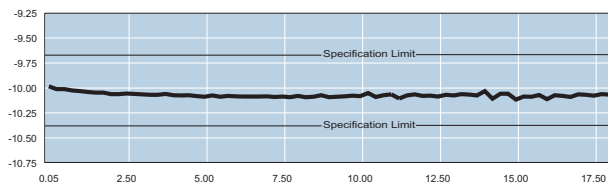

Typical Attenuation Performance of 4M-10

MAXIMUM SWR:

| Frequency (GHz) | 3M | 4M |
|-----------------|------|------|
| dc - 4 | 1.15 | 1.15 |
| 4 - 8 | 1.20 | 1.20 |
| 8 - 12.4 | 1.25 | 1.25 |
| 12.4 - 18 | --- | 1.35 |

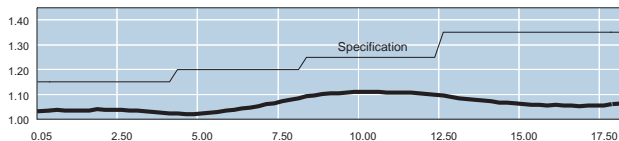

Typical SWR of a Model 4M-10

POWER RATING: 2 watts **average** to 25°C ambient temperature, derated linearly to 0.5 watts at 125°C. 500 watts **peak** (5 μsec pulse width; 0.2% duty cycle).

POWER COEFFICIENT: < 0.005 dB/dB/watts

TEMPERATURE COEFFICIENT: < 0.0004 dB/dB/°C

TEMPERATURE RANGE: -55°C to +125°C

TEST DATA: Swept data plots of attenuation and SWR from 50 MHz to 12.4 / 18 GHz is available at additional cost.

CONNECTORS: SMA connectors per MIL-STD-348 interface dimensions - mate nondestructively with MIL-C-39012 connectors.

CONSTRUCTION: Passivated stainless steel body and connectors; gold plated beryllium copper contacts.

WEIGHT (Both Models):

| dB VALUE | WEIGHT (Net) |
|----------------|----------------|
| 1 - 10, 20 | 10 g (0.35 oz) |
| 30, 40, 50, 60 | 20 g (0.70 oz) |

PHYSICAL DIMENSIONS:

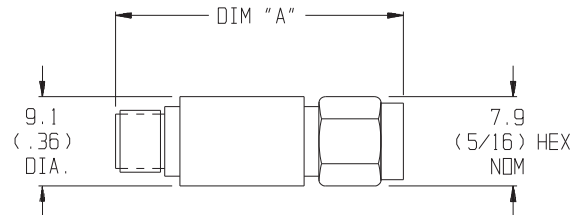

| dB VALUE | DIM A ± 0.5 (0.02) | | |
|----------------|--------------------|-------------|-------------|
| | STD | Prefix F | Prefix M |
| 1 - 10, 20 | 30.5 (1.20) | 29.7 (1.17) | 32.3 (1.27) |
| 30, 40, 50, 60 | 47.0 (1.85) | 46.2 (1.82) | 47.7 (1.88) |

NOTE: All dimensions are given in mm (inches) and are maximum, unless otherwise specified.

MODEL NUMBER DESCRIPTION:

Example:

***4M - XX**

Basic Model Number

Attenuation Value (dB)

*Add Prefix M for double male and F for double female connectors.

Models 3330A & 3331A General Purpose, Subminiature SMA

dc to 18.0 GHz
2 Watts



Features

- /// **Low Cost** - These general purpose attenuators offer subminiature size, broadband frequency response, and attenuation values from 1 to 30 dB at low, competitive prices.
- /// **Two Configurations** - Round body Model 3330A and a hex body Model 3331A.
- /// **Ideal for Bulk Quantity Requirements.**

Specifications

NOMINAL IMPEDANCE: 50 Ω

FREQUENCY RANGE: dc to 18.0 GHz

MAXIMUM DEVIATION OVER FREQUENCY:

| Nominal ATTN (dB) | Deviation (dB) |
|-------------------|----------------|
| 0-6 | ± 0.30 |
| 7-10, 20 | ± 0.50 |
| 30 | ± 0.75 |

MAXIMUM SWR:

| Frequency (GHz) | SWR |
|-----------------|------|
| dc - 4 | 1.15 |
| 4 - 12.4 | 1.30 |
| 12.4 - 18.0 | 1.40 |

POWER RATING: 2 watts **average** to 25°C ambient temperature, derated linearly to 0.5 watts @ 125°C. 250 watts **peak** (5 μsec pulse width; 0.4% duty cycle).

TEMPERATURE RANGE: -55°C to +125°C.

CONNECTORS: SMA connectors per MIL-STD-348 interface dimensions mate nondestructively with MIL-C-39012 connectors.

CONSTRUCTION: Passivated stainless steel body and connectors; gold plated beryllium copper contacts.

WEIGHT: 5.6 g (0.2 oz) maximum (Both Models)

PHYSICAL DIMENSIONS:

Model 3330A (Round):

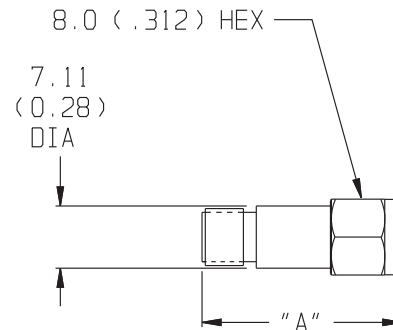

Model 3331A (Hex):

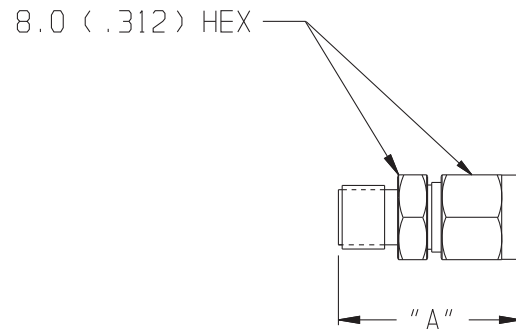

| dB VALUE | DIM A |
|----------|------------------------------|
| 1 - 10 | 21.72 ± 0.51 (0.855 ± 0.020) |
| 20, 30 | 25.02 ± 0.51 (0.985 ± 0.020) |

NOTE: All dimensions are given in mm (inches) and are maximum, unless otherwise specified.

MODEL NUMBER DESCRIPTION:

Example:

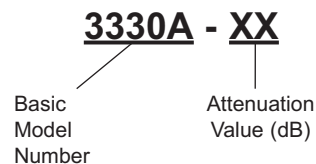

Fixed Coaxial Attenuators



Model 4H Hex Body Precision SMA Connectors

dc to 18.6 GHz
2 Watts



Features

- /// **Subminiature** - These attenuators offer the smallest package size with broadband frequency response, and attenuation values from 0 to 10, 12, 15, 20 & 30 dB.
- /// **Designed to meet environmental requirements of MIL-DTL-3933.**
- /// **Precision SMA Connectors.**
- /// **Usable to 23 GHz.**

Specifications

NOMINAL IMPEDANCE: 50 Ω

FREQUENCY RANGE: dc to 18.6 GHz

MAXIMUM DEVIATION OVER FREQUENCY:

| Nominal ATTN (dB) | Deviation (dB) |
|-------------------|----------------|
| 0 | ± 0.40 |
| 1-10 | ± 0.30 |
| 12, 15, 20, 30 | ± 0.70 |

MAXIMUM SWR:

| Frequency (GHz) | SWR |
|-----------------|------|
| dc - 12.4 | 1.25 |
| 12.4 - 18.6 | 1.35 |

POWER RATING: 2 watts **average** to 25°C ambient temperature, derated linearly to 0.5 watts @ 125°C. 250 watts **peak** (5 μ sec pulse width; 0.4% duty cycle).

POWER COEFFICIENT: < 0.005 dB/dB/watt

TEMPERATURE COEFFICIENT: < 0.0004 dB/dB/°C

TEMPERATURE RANGE: -50°C to +125°C

CONNECTORS: SMA connectors per MIL-STD-348 interface dimensions mate nondestructively with MIL-C-39012 connectors.

CONSTRUCTION: Stainless steel body and connectors; gold plated beryllium copper contacts.

WEIGHT: 5.0 g (0.18 oz) maximum

PHYSICAL DIMENSIONS:

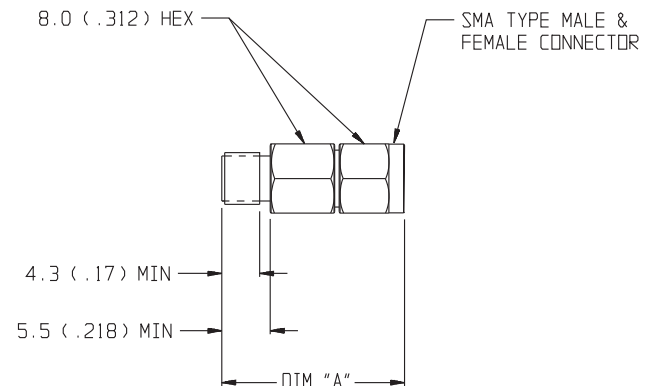

| dB VALUE | DIM A |
|------------|-------------|
| 0-10 | 19.0 (0.75) |
| 12, 15, 20 | 21.6 (0.85) |
| 30 | 24.0 (0.95) |

NOTE: All dimensions are given in mm (inches) and are maximum, unless otherwise specified.

MODEL NUMBER DESCRIPTION:

Example:

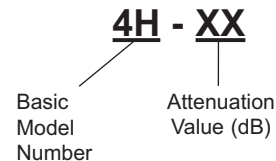

Model 56 3.5mm Connectors

dc to 28.0 GHz 2 Watts



Features

- /// Precision 3.5mm Connectors.
- /// Low SWR & Flat Response.

Specifications

NOMINAL IMPEDANCE: 50 Ω

FREQUENCY RANGE: dc to 28.0 GHz

MAXIMUM DEVIATION OVER FREQUENCY (dB):

| Nominal ATTN (dB) | DEVIATION (dB) |
|-------------------|----------------|
| 0 | + 0.50 |
| 3, 6, 10 | ± 0.60 |
| 20, 30 | ± 0.75 |

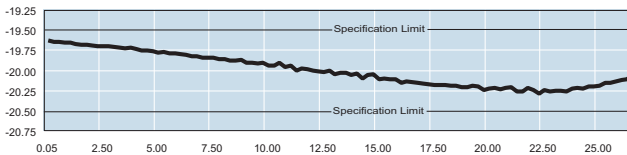

Typical Attenuation Accuracy of a 56-20

MAXIMUM SWR:

| Frequency (GHz) | SWR |
|-----------------|------|
| dc - 8 | 1.10 |
| 8 - 12.4 | 1.15 |
| 12.4 - 28 | 1.25 |

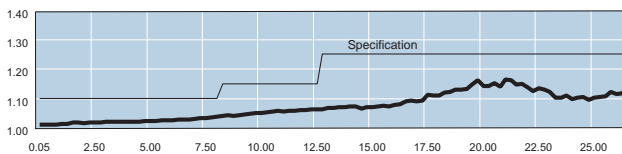

Typical SWR of a 56-20

POWER RATING: 2 watts **average** to 25°C ambient temperature, derated linearly to 0.2 watts at +100°C. 500 watts **peak** (5 μsec pulse width; 0.2% duty cycle).

POWER COEFFICIENT: < 0.005 dB/dB/watts

TEMPERATURE COEFFICIENT: < 0.0004 dB/dB/°C

TEMPERATURE RANGE: -55 °C to +100 °C.

TEST DATA: Swept data plots of attenuation and SWR from 50 MHz to 28 GHz is available at additional cost.

CONNECTORS: 3.5mm connectors - contact pin recession (0.003 maximum).

CONSTRUCTION: Stainless steel body and connectors; gold plated beryllium copper contacts.

WEIGHT: 8 g (0.28 oz) maximum

PHYSICAL DIMENSIONS:

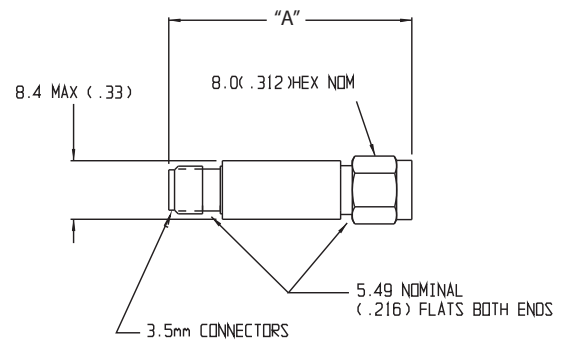

| Model | DIM A |
|-------|------------------------|
| 56 | 32.5±0.5 (1.275±0.002) |
| F56 | 35.9±0.5 (1.415±0.002) |
| M56 | 29.0±0.5 (1.140±0.002) |

NOTE: All dimensions are given in mm (inches) and are maximum, unless otherwise specified.

MODEL NUMBER DESCRIPTION:

Example:

***56 - XX**

Basic Model Number

Attenuation Value (dB)

* Add Prefix M for double male and F for double female connectors.

ATTENUATOR SET (AS-20): Model 56 is also available in a Attenuator Set which includes five different attenuators (3, 6, 10, 20, 30 dB). Refer to Attenuator Sets data sheet for more information.

Fixed Coaxial Attenuators



Model 87 SMK Connectors

dc to 32.0 GHz
2 Watts



Features

- /// Available in 0.5 dB increments from 0-30 dB.
- /// Rugged injection molded connectors.
- /// Designed to meet environmental requirements of MIL-DTL-3933.
- /// New Lower Cost Commercial Version.

Specifications

NOMINAL IMPEDANCE: 50 Ω

FREQUENCY RANGE: dc to 32.0 GHz

MAXIMUM DEVIATION OVER FREQUENCY:

| Nominal ATTN (dB) | Deviation (dB) |
|-------------------|----------------|
| 0 | + 0.5 / -0.0 |
| 0.5 - 12 | ± 0.50 |
| 12.5 - 20 | ± 1.00 |
| 20.5 - 30 | ± 2.00 |

MAXIMUM SWR:

| Frequency (GHz) | SWR |
|-----------------|------|
| dc - 32 | 1.25 |

POWER RATING: 2 watts **average** to 25°C ambient temperature, derated linearly to 0.5 watts at 100°C. 500 watts **peak** (5 μsec pulse width; 0.2% duty cycle).

POWER COEFFICIENT: < 0.005 dB/dB/watts

TEMPERATURE COEFFICIENT: < 0.0004 dB/dB/°C

TEMPERATURE RANGE: -55°C to +100°C

TEST DATA: Swept data plots of attenuation and SWR from 50 MHz to 32 GHz is available at additional cost.

CONNECTORS: SMK (2.92mm) connectors - mate non-destructively with SMA, 3.5mm and SMK (2.92mm) connectors.

CONSTRUCTION: Passivated stainless steel body and connectors; gold plated beryllium copper contacts.

WEIGHT: 8 g (0.28 oz)

PHYSICAL DIMENSIONS:

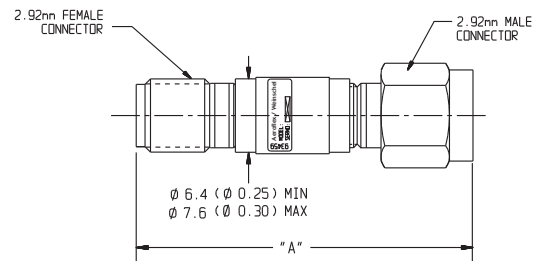

| dB VALUE | DIM A ± 0.5 (0.02) |
|----------|--------------------|
| 0-12 | 28.6 (1.15) |
| 12.5-20 | 31.2 (1.23) |
| 20.5-30 | 33.8 (1.33) |

NOTE: All dimensions are given in mm (inches) and are maximum, unless otherwise specified.

MODEL NUMBER DESCRIPTION:

Example:

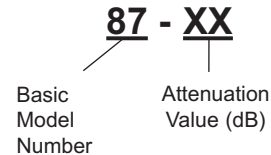

Model 84A Ruggedized 2.4mm Connectors

dc to 40.0 GHz
2 Watts



Features

- /// Useable to 42 GHz.
- /// Designed to meet environmental requirements of MIL-DTL-3933.

Specifications

NOMINAL IMPEDANCE: 50 Ω
FREQUENCY RANGE: dc to 40.0 GHz

| MAXIMUM DEVIATION OVER FREQUENCY: | | |
|-----------------------------------|----------------|---------|
| Nominal ATTN (dB) | Deviation (dB) | |
| | dc-26.5 | 26.5-40 |
| 3, 6, 10 | ± 0.50 | ± 1.00 |
| 20, 30 | ± 0.80 | ± 1.50 |

| MAXIMUM SWR: | |
|-----------------|------|
| Frequency (GHz) | SWR |
| dc - 26.5 | 1.25 |
| 26.5 - 40 | 1.45 |

POWER RATING: 2 watts **average** to 25 °C ambient temperature, derated linearly to 0.1 watt at 125 °C. 200 watts **peak** (5 μsec pulse width; 0.5 % duty cycle).

POWER COEFFICIENT: < 0.005 dB/dB/watts

TEMPERATURE COEFFICIENT: < 0.0004 dB/dB/°C

TEMPERATURE RANGE: -55°C to +125°C

TEST DATA: Swept data plots of attenuation and SWR from 50 MHz to 40 GHz is available at additional cost.

CONNECTORS: 2.4mm connectors mate nondestructively with other 2.4mm connectors. Contact Pin Recession (0 to 0.003)

CONSTRUCTION: Stainless steel body; gold plated beryllium copper contacts and brass connectors.

WEIGHT: 13 g (0.46 oz.) maximum

PHYSICAL DIMENSIONS:

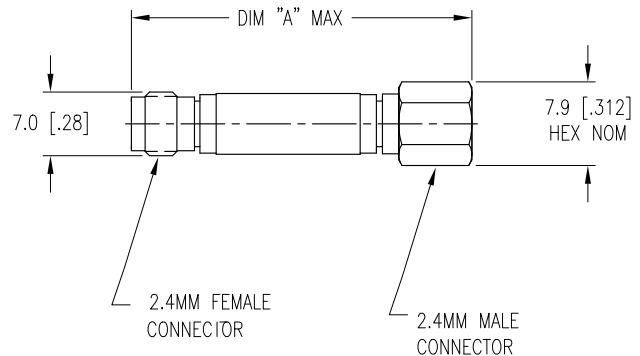

| Model | DIM A |
|-------|--------------|
| 84A | 38.10 (1.50) |
| F84A | 34.00 (1.34) |
| M84A | 42.20 (1.66) |

NOTE: All dimensions are given in mm (inches) and are maximum, unless otherwise specified.

MODEL NUMBER DESCRIPTION:

Example:

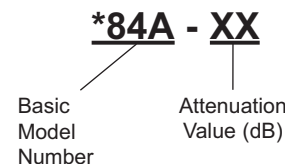

* Add Prefix M for double male and F for double female connectors.

Fixed Coaxial Attenuators



Model 54A SMK Connectors

dc to 40.0 GHz
2 Watts



Features

- Useable to 42 GHz.
- Designed to meet environmental requirements of MIL-DTL-3933.

Specifications

NOMINAL IMPEDANCE: 50 Ω
FREQUENCY RANGE: dc to 40.0 GHz

MAXIMUM DEVIATION OVER FREQUENCY:

| Nominal ATTN (dB) | Deviation (dB) | |
|----------------------|----------------|---------|
| | dc-26.5 | 26.5-40 |
| 3, 6, 10 | ± 0.50 | ± 1.00 |
| 20, 30 | ± 0.80 | ± 1.50 |

MAXIMUM SWR:

| Frequency (GHz) | SWR |
|-----------------|------|
| dc - 26.5 | 1.25 |
| 26.5 - 40 | 1.45 |

POWER RATING: 2 watts **average** to 25 °C ambient temperature, derated linearly to 0.1 watt at 125 °C. 200 watts **peak** (5 μsec pulse width; 0.5 % duty cycle).

POWER COEFFICIENT: < 0.005 dB/dB/watts

TEMPERATURE COEFFICIENT: < 0.0004 dB/dB/°C

TEMPERATURE RANGE: -55 °C to +125 °C

TEST DATA: Swept data plots of attenuation and SWR from 50 MHz to 40 GHz is available at additional cost.

CONNECTORS: SMK (2.92mm) connectors - mate nondestructively with SMA, 3.5mm and SMK (2.92mm) connectors.

CONSTRUCTION: Stainless steel body and connectors; gold plated beryllium copper contacts.

WEIGHT: 13 g (0.46 oz.) maximum

PHYSICAL DIMENSIONS:

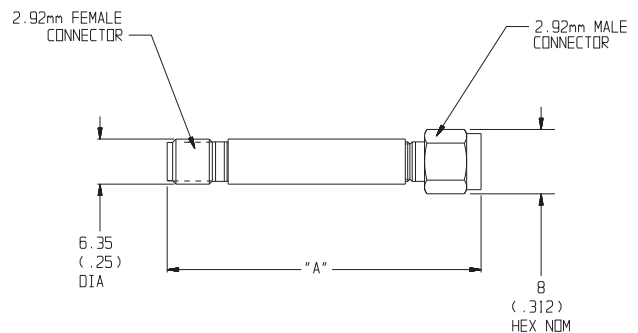

| Model | DIM A |
|-------|-------------|
| 54A | 39.9 (1.57) |
| F54A | 37.9 (1.49) |
| M54A | 42.0 (1.64) |

NOTE: All dimensions are given in mm (inches) and are maximum, unless otherwise specified.

MODEL NUMBER DESCRIPTION:

Example:

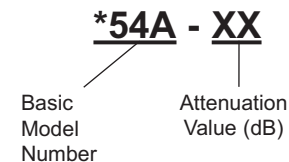

* Add Prefix M for double male and F for double female connectors.

Model 1W General Purpose, Type N

dc to 4.0 GHz
2 Watts

RoHS



CONNECTORS: Type N (male/female) connectors - mate nondestructively with MIL-C-39012 connectors.

CONSTRUCTION: Nickel-plated brass body and connectors, gold plated Beryllium contacts

WEIGHT: 65 g (2.5 oz) maximum

PHYSICAL DIMENSIONS:

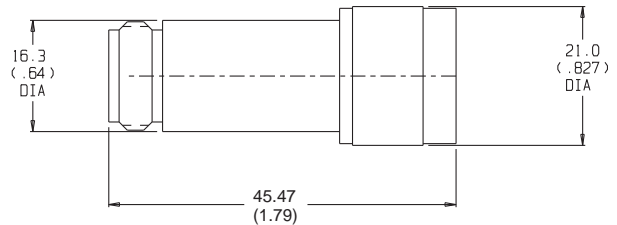

NOTE: All dimensions are given in mm (inches) and are maximum, unless otherwise specified.

MODEL NUMBER DESCRIPTION:

Example:

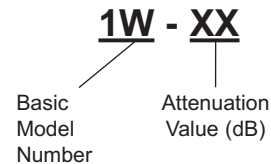

Features

- /// **Attenuation Values from 1 to 10, 20 dB.**
- /// **Low Cost**
- /// **Wireless Applications** - Optimized for use in the wireless communications bands.

Specifications

NOMINAL IMPEDANCE: 50 Ω

FREQUENCY RANGE: dc to 4.0 GHz

| MAXIMUM DEVIATION OVER FREQUENCY: | |
|-----------------------------------|----------------|
| Nominal ATTN (dB) | Deviation (dB) |
| 1 -6 | ± 0.30 |
| 7 -10, 20 | ± 0.50 |

| MAXIMUM SWR: | |
|-----------------|------|
| Frequency (GHz) | SWR |
| dc - 8.0 | 1.25 |

POWER RATING: 2 watts **average** to 25°C ambient temperature, derated linearly to 0.5 watts @ 105°C. 250 watts **peak** (5 μsec pulse width; 0.4% duty cycle).

POWER COEFFICIENT: < 0.005 dB/dB/watt

TEMPERATURE COEFFICIENT: < 0.0004 dB/dB/°C

TEMPERATURE RANGE: -20°C to +105°C.

Fixed Coaxial Attenuators



Model 55 TNC Connectors

dc to 18.0 GHz
5 Watts



Features

- /// **Quality TNC Connectors** - This Attenuator incorporates an improved 18 GHz TNC connector design standardized through the IEC.
- /// **Designed to meet environmental requirements of MIL-DTL-3933.**

Specifications

NOMINAL IMPEDANCE: 50 Ω

FREQUENCY RANGE: dc to 18.0 GHz

MAXIMUM DEVIATION OVER FREQUENCY:

| Nominal ATTN (dB) | Deviation (dB) |
|-------------------|----------------|
| 1 - 6 | ± 0.40 |
| 7 -10, 20 | ± 0.50 |
| 30 | ± 0.90 |

MAXIMUM SWR:

| Frequency (GHz) | SWR |
|-----------------|------|
| dc - 4 | 1.15 |
| 4 - 8 | 1.20 |
| 8 - 12.4 | 1.25 |
| 12.4 - 18 | 1.35 |

POWER RATING: 5 watts **average** @ 25°C ambient temperature, derated linearly to 0.5 watt @ 125°C. 1 kilowatt **peak** (5 μsec pulse width; 0.25% duty cycle)

POWER COEFFICIENT: < 0.005 dB/dB/watt

TEMPERATURE COEFFICIENT: < 0.0004 dB/dB/ °C

TEMPERATURE RANGE: -55°C to +125°C

TEST DATA: Swept data plots of attenuation and SWR from 50 MHz to 18 GHz is available at additional cost.

CONNECTORS: TNC connectors per MIL-STD-348 interface dimensions - mate nondestructively with MIL-C-39012 connectors.

CONSTRUCTION: Stainless steel body and connectors; gold plated beryllium copper contacts.

WEIGHT: 28 g (1 oz) maximum

PHYSICAL DIMENSIONS:

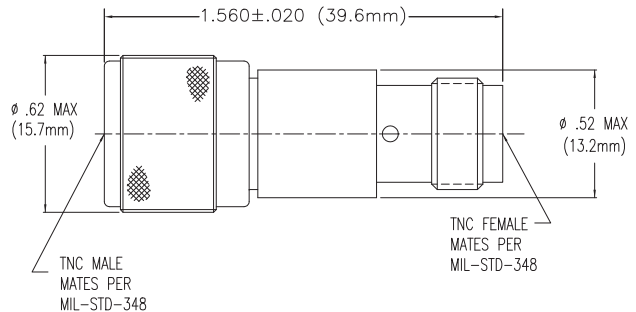

NOTE: All dimensions are given in mm (inches) and are maximum, unless otherwise specified.

MODEL NUMBER DESCRIPTION:

Example:

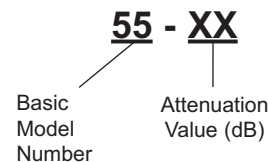

Model 1 Model 2 Precision N Connectors

dc to 12.4 GHz
dc to 18.0 GHz
5 Watts

RoHS



Features

- /// Rugged injection molded connectors.
- /// Designed to meet environmental requirements of MIL-DTL-3933.

Specifications

NOMINAL IMPEDANCE: 50 Ω

FREQUENCY RANGE: Model 1: dc to 12.4 GHz
Model 2: dc to 18.0 GHz

| MAXIMUM DEVIATION OVER FREQUENCY: | | |
|-----------------------------------|--------|--------|
| Nominal ATTN (dB) | 1 | 2 |
| 1-9 | ± 0.30 | ± 0.30 |
| 10, 20 | ± 0.30 | ± 0.50 |
| 30, 40 | ± 0.75 | ± 1.00 |
| 50 | ± 0.75 | ± 1.25 |
| 60 | ± 1.00 | ± 1.50 |

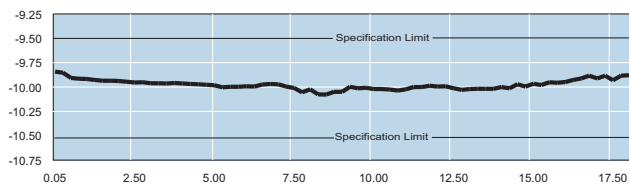

Typical Attenuation Performance of Model 2-10

| MAXIMUM SWR: | | |
|-----------------|-------|------|
| Frequency (GHz) | 1 | 2 |
| dc - 4 | 1.15 | 1.15 |
| 4 - 8 | 1.20 | 1.20 |
| 8 - 12.4 | 1.25 | 1.25 |
| 12.4 - 18 | - - - | 1.35 |

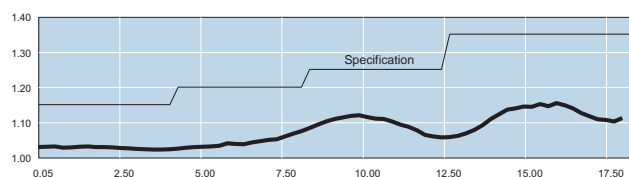

Typical SWR of Model 2-10

POWER RATING: 5 watts **average** @ 25°C ambient temperature, derated linearly to 0.5 watt @ 125°C. 1 kilowatt **peak** (5 μsec pulse width; 0.25% duty cycle)

POWER COEFFICIENT: <0.005 dB/dB/Watt

TEMPERATURE COEFFICIENT: < 0.0004 dB/dB/°C

TEMPERATURE RANGE: -55°C to +125°C

TEST DATA: Swept data plots of attenuation and SWR from 50 MHz to 12.4 / 18 GHz is available at additional cost.

CONNECTORS: Precision Type N connectors per MIL-STD-348 interface dimensions - mate nondestructively with MIL-C-39012 connectors.

CONSTRUCTION: Stainless steel body and connectors; gold plated beryllium copper contacts.

WEIGHT:

| dB VALUE | WEIGHT (Net) |
|----------------|----------------|
| 1 - 10, 20, 30 | 70 g (2.6 oz) |
| 40, 50, 60 | 100 g (3.6 oz) |

PHYSICAL DIMENSIONS:

ATTENUATOR SET (AS-6): Model 2 is also available in a

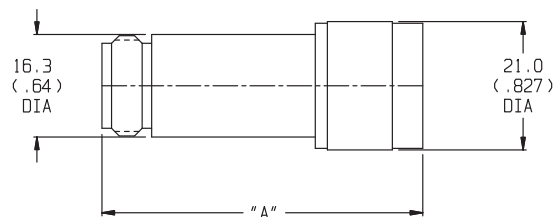

| dB VALUE | DIM A |
|--------------|-------------|
| 1-10, 20, 30 | 57.9 (2.28) |
| 40, 50, 60 | 68.1 (2.68) |

NOTE: All dimensions are given in mm (inches) and are maximum, unless otherwise specified.

MODEL NUMBER DESCRIPTION:

Example:

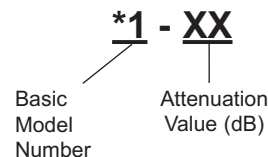

*Add Prefix M for double male or F for double female connectors.

Attenuator Set which includes four different attenuators (3, 6, 10, 20 dB). Refer to Attenuator Sets data sheet for more information.

Fixed Coaxial Attenuators



Model 44 Lab Standard, Precision N Connectors

dc to 18.0 GHz
5 Watts



Features

- /// Precision Connectors
- /// Test data - A certificate of test supplied with each attenuator.
- /// Hex Nut Connector - Allows for use of a torque wrench to improve connector repeatability.
- /// Designed to meet environmental requirements of MIL-DTL-3933.

Specifications

NOMINAL IMPEDANCE: 50 Ω

FREQUENCY RANGE: dc to 18.0 GHz

MAXIMUM DEVIATION OVER FREQUENCY:

| Nominal ATTN (dB) | Deviation (dB) |
|-------------------|----------------|
| 1 - 9 | ± 0.30 |
| 10, 20 | ± 0.50 |
| 30, 40 | ± 1.00 |
| 50 | ± 1.25 |
| 60 | ± 1.50 |

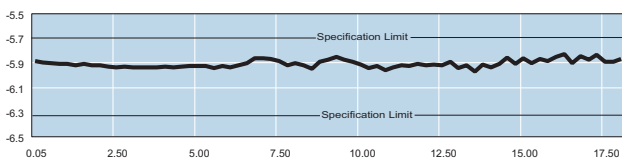

Typical Attenuation Accuracy of a 44-6

MAXIMUM SWR:

| Frequency (GHz) | SWR |
|-----------------|------|
| dc - 4 | 1.15 |
| 4 - 12.4 | 1.20 |
| 12.4 - 18 | 1.25 |

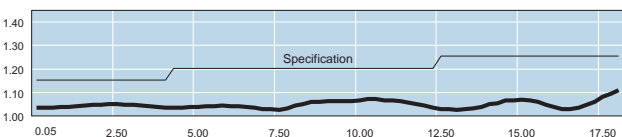

Typical SWR of a 44-6

POWER RATING: 5 watts **average** @ 25°C ambient temperature, derated linearly to 0.5 watt @ 125°C. 1 kilowatt **peak** (5 μsec pulse width; 0.25% duty cycle)

POWER COEFFICIENT: <0.005 dB/dB/Watt

TEMPERATURE COEFFICIENT: < 0.0004 dB/dB/°C

TEMPERATURE RANGE: -55°C to +125°C

TEST DATA: Swept data plots of attenuation and SWR from 50 MHz to 18 GHz.

CONNECTORS: Precision Type N per MIL-STD-348 interface dimensions - mate nondestructively with MIL-C-39012 connectors. Coupling Torque: 14 ± 1 in/lbs.

CONSTRUCTION: Brass Body (plated) and Stainless steel connectors; gold plated beryllium copper contacts.

WEIGHT:

| dB VALUE | WEIGHT (Net) |
|----------------|----------------|
| 1 - 10, 20, 30 | 100 g (3.5 oz) |
| 40, 50, 60 | 140 g (4.5 oz) |

PHYSICAL DIMENSIONS:

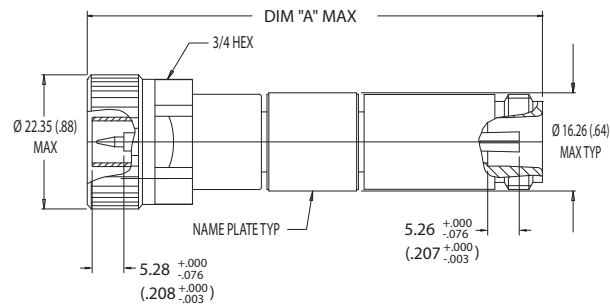

| dB VALUE | Prefix M | DIM A STD | Prefix F |
|--------------|------------|------------|-------------|
| 0-10, 20, 30 | 76.2 (3.0) | 76.2 (3.0) | 77.7 (3.06) |
| 40, 50, 60 | 86.4 (3.4) | 86.4 (3.4) | 87.9 (3.46) |

NOTE: All dimensions are given in mm (inches) and are maximum, unless otherwise specified.

MODEL NUMBER DESCRIPTION:

Example:

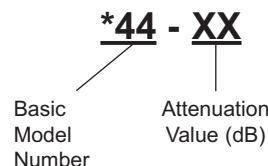

*Add Prefix M for double male or F for double female connectors.

ATTENUATOR SET (AS-18): Model 44 is also available in a Attenuator Set which includes six different attenuators (1, 3, 6, 10, 20, 30 dB). Refer to Attenuator Sets data sheet for more information.

Model 69A Bi-directional Design, SMA Connectors

dc to 18.0 GHz
5 Watts



Features

- /// Compact Construction - Lowest size/power ratio.
- /// Precision Injection Molded Connectors
- /// Designed to meet environmental requirements of MIL-DTL-3933.
- /// Flat Response & Low SWR.

Specifications

NOMINAL IMPEDANCE: 50 Ω
FREQUENCY RANGE: dc to 18.0 GHz

| MAXIMUM DEVIATION OVER FREQUENCY: | |
|-----------------------------------|----------------|
| Nominal ATTN (dB) | Deviation (dB) |
| 1 - 6 | ± 0.30 |
| 7 - 10, 20, 30 | ± 0.50 |

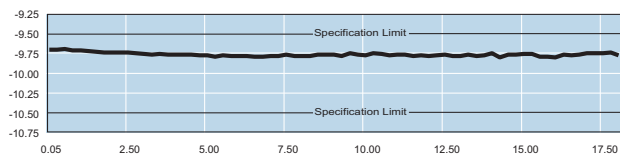

Typical Attenuation Accuracy of a 69A-10

| MAXIMUM SWR: | |
|-----------------|------|
| Frequency (GHz) | SWR |
| dc - 8 | 1.15 |
| 8 - 18 | 1.25 |

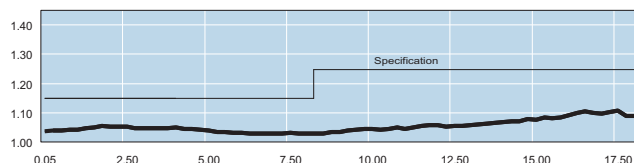

Typical SWR of a 69A-10

POWER RATING (mounted horizontally): 5 watts average (bi-directional) to 25°C ambient temperature, derated linearly to 0.5 Watt @ 125°C. 500 watts peak (5 μsec pulse width; 0.5% duty cycle).

POWER COEFFICIENT: <0.003 dB/dB/watt

TEMPERATURE COEFFICIENT: <0.0004 dB/dB/°C

TEMPERATURE RANGE: -55 °C to 125 °C

TEST DATA: Swept data plots of attenuation and SWR from 50 MHz to 18 GHz is available at additional cost.

CONNECTORS: SMA connectors per MIL-STD-348 interface dimensions - mate nondestructively with SMK, 3.5mm, 2.92mm and SMA connectors per MIL-C-39012 .

| Connector Options | Type/Description |
|-------------------|------------------|
| 1 | SMA, Female |
| 2 | SMA, Male |

CONSTRUCTION: Black, finned aluminum body, stainless steel connectors; gold plated beryllium copper contacts.

WEIGHT: Net 10 g (0.35 oz) maximum

PHYSICAL DIMENSIONS:

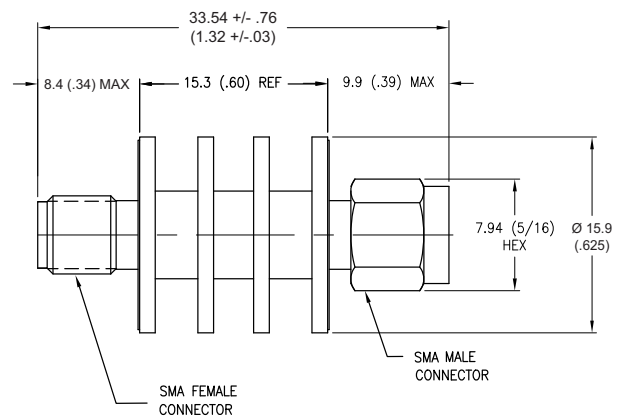

NOTE: All dimensions are given in mm (inches) and are maximum, unless otherwise specified.

MODEL NUMBER DESCRIPTION:

Example:

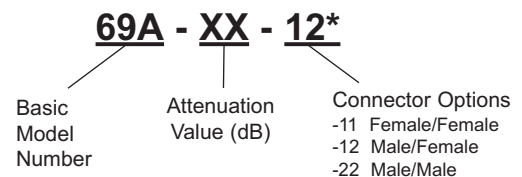

*Unit is bi-directional and full power may be applied to either connector.

Fixed Coaxial Attenuators



Model 75A Bi-directional Design, SMK Connectors

dc to 40.0 GHz
5 Watts



Features

- /// Usable to 42 GHz
- /// Compact Construction - Lowest size/power ratio.
- /// Precision Injection Molded Connectors
- /// Designed to meet environmental requirements of MIL-DTL-3933.
- /// Flat Response & Low SWR

Specifications

NOMINAL IMPEDANCE: 50 Ω

FREQUENCY RANGE: dc to 42.0 GHz

MAXIMUM DEVIATION OVER FREQUENCY:

| Nominal ATTN (dB) | Deviation (dB) | |
|-------------------|----------------|-------------|
| | dc-26.5 GHz | 26.5-40 GHz |
| 3, 6, 10 | ± 0.50 | ± 1.00 |
| 20, 30 | ± 0.80 | ± 1.50 |

MAXIMUM SWR:

| Frequency (GHz) | SWR |
|-----------------|------|
| dc - 26.5 | 1.25 |
| 26.5 - 40 | 1.45 |

POWER RATING (mounted horizontally): 5 watts average (bi-directional) to 25°C ambient temperature, derated linearly to 0.5 Watt @ 125°C. 200 watts peak (5 μsec pulse width; 1.25% duty cycle).

POWER COEFFICIENT: <0.002 dB/dB/watt

TEMPERATURE COEFFICIENT: <0.0004 dB/dB/°C

TEMPERATURE RANGE: -55 °C to 125 °C

TEST DATA: Swept data plots of attenuation and SWR from 50 MHz to 40 GHz.

CONNECTORS: SMK (2.92mm) Male/Female connectors - mate nondestructively with SMA, 3.5mm and SMK (2.92mm) connectors.

| Connector Options | Type/Description |
|-------------------|------------------|
| 1 | 2.92mm, Female |
| 2 | 2.92mm, Male |

CONSTRUCTION: Black, finned aluminum body, gold plated beryllium copper contacts.

WEIGHT: 200 g (7.0 oz.) maximum

PHYSICAL DIMENSIONS:

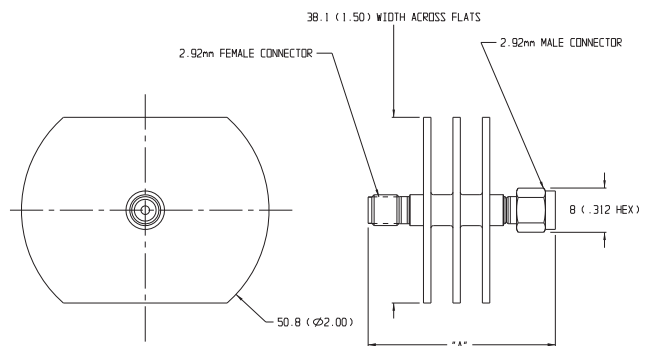

| Dash No. | Connector Type | DIM A |
|----------|----------------------|-------------|
| 11 | 2.92mm Female/Female | 39.9 (1.56) |
| 12 | 2.92mm Male/Female | 44.1 (1.74) |
| 22 | 2.92mm Male/Male | 48.8 (1.92) |

NOTE: All dimensions are given in mm (inches) and are nominal, unless otherwise specified.

MODEL NUMBER DESCRIPTION:

Example:

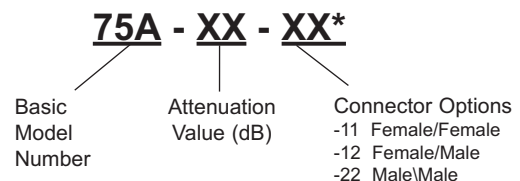

*Unit is bi-directional and full power may be applied to either connector.

Attenuator Sets

dc to 18.0/26.5 GHz



Model AS-6
(Type N)



Model AS-18
(Precision Type N)



Model AS-20
(3.5mm)

Features

- /// **Test Data:** Test Data for each attenuator is provided.
- /// **Data furnished:** AS-6 and AS-18, Insertion loss & SWR ports 1 and 2 test data supplied at 0.05, 4.0, 8.0, 12.4 and 18.0 GHz and AS-20, Insertion loss & SWR ports 1 and 2 test data supplied at 0.05, 4.0, 8.0, 12.4, 18.0 and 28.0GHz.
- /// **Wide Temperature Range:** -55 °C to 100 °C. Full rated power to 25 °C. Derated Linearity to 0.5 watts @ 125 °C.
- /// **Uniform Phase Characteristics:** Excellent unit-to-unit tracking and phase linearly with frequency.
- /// **Rugged Construction:** Designed to meet all environmental requirements of MIL-DTL-3933.
- /// **High Repeatability Connectors:**
 - AS-6: Type N per MIL-STD-348
 - AS-18: Precision N per MIL-STD-348
 - AS-20: Precision 3.5mm
- /// **Durable Storage Case.**

Specifications

| Set Model Number | Standard Model Number | Nominal Values (dB) | Frequency Range (GHz) | Average Power (W) | Connector Type | Maximum* SWR | Page No.** |
|------------------|-----------------------|---------------------|-----------------------|-------------------|----------------|--------------|------------|
| AS-6 | 2 | 3, 6, 10, 20 | dc-18 GHz | 5 | N | 1.15 - 1.35 | 36 |
| AS-18 | 44 | 1, 3, 6, 10, 20, 30 | dc-18 GHz | 5 | N | 1.15 - 1.25 | 37 |
| AS-20 | 56 | 3, 6, 10, 20, 30 | dc-28 GHz | 2 | 3.5mm | 1.10 - 1.25 | 30 |

*Varies with frequency.

**Refer to indicated page for more detailed attenuator specifications.

STORAGE CASE DIMENSIONS:

- Model AS-6: 136.5mm (5-3/8 in) long x 125.4mm (4-15/16 in) wide x 35.6mm (2-3/16 in) high
- Model AS-18: 215.9mm (8.5 in) long x 273mm (10-3/4 in) wide x 63.5mm (2-1/2 in) high
- Model AS-20: 139.7mm (5-1/2 in) long x 123.8mm (4-7/8 in) wide x 60.3mm (2-3/8 in) high

Fixed Coaxial Attenuators



High Reliability Attenuators





Designed to meet requirements of MIL-DTL-3933, CLASS III/IV, N/S

dc to 18.0 GHz

2 to 25 Watts



Basic Model Information...

| Part Number | Description | Outline Drawing/ Dimensions | |
|---|---|---|---|
| 272N-XX (Non-screened) 272S-XX (Screened) (Available in 1- 10, 20 , 30 & 40 dB) | dc to 18 GHz 5 watts Average; 1 kW peak | Refer to Aeroflex / Weinschel Standard Model 272 (page 41a) for specifications. |  |
| 273N-XX (Non-screened) 273S-XX (Screened) (Available in 0 - 10 in 0.5 dB steps, 11- 20 in 1 dB steps & 25 - 40 in 5 dB steps) | dc to 18 GHz 2 watts Average; 500 W peak | Refer to Aeroflex / Weinschel Standard Model 273 (page 41b) for specifications. |  |
| 274N-XX (Non-screened) 274S-XX (Screened) (Available in 0 - 20 in 0.5 dB steps, 30, & 40 dB) | dc to 18 GHz 2 watts Average; 500 W peak | Refer to Aeroflex / Weinschel Standard Model 274 (page 41c) for specifications. |  |
| 276N-XX (Non-screened) 276S-XX (Screened) (Available in 3, 6, 10, 20, 30 dB) | dc to 18 GHz 25 Watts Average; 2 kW peak | Refer to Aeroflex / Weinschel Standard Model 276 (page 41d) for specifications. |  |

Features

- /// Screened and Non-screened models available.
- /// Choice of attenuation values from 0 to 40 dB.
- /// Frequency Ranges from dc to 18 GHz.
- /// Power capability from 2 to 25 watts.
- /// Test Data supplied at additional cost as follows:
 - Non-screened (N):** Swept data plots of Attenuation and SWR across the frequency band.
 - Screened (S):** Swept data plots of Attenuation and SWR across the frequency band. Film, Standard data package includes lot record performance showing pass/fail quantities for all tests and test reports as applicable.
- /// Type N and SMA Connectors.

Screening

Units are screened as follows:

"N" versions:

- SWR
- Attenuation
- Peak Power

"S" versions:

- Thermal Shock
- Monitored Thermal Cycle (MTC)
- Attenuation w/Parts Assembly Verification (PAV)
- Conditioning
- Peak Power
- Attenuation
- SWR
- Radiographics

MODEL NUMBER DESCRIPTION:

Example:

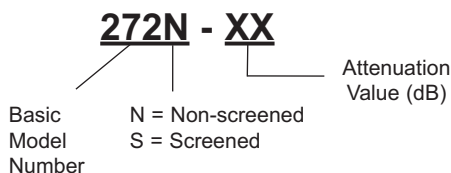

Model 272
High Reliability, N Connectors
Designed to meet requirements of MIL-DTL-3933, CLASS III/IV, N/S

dc to 18.0 GHz
2 Watts



RoHS



Features

- /// Rugged injection molded connectors.
- /// Screened (Model 272S) and Non-screened (Model 272N) designs available.
- /// Available in 1- 10, 20, 30 & 40 dB.
- /// Test Data supplied at additional cost as follows:
Non-screened (N): Swept data plots of Attenuation and SWR across the frequency band.
Screened (S): Swept data plots of Attenuation and SWR across the frequency band. Film, Standard data package includes lot record performance showing pass/fail quantities for all tests and test reports as applicable.

Specifications

NOMINAL IMPEDANCE: 50 Ω

FREQUENCY RANGE: dc to 18.0 GHz

| MAXIMUM DEVIATION OVER FREQUENCY: | |
|-----------------------------------|--------|
| Nominal ATTN (dB) | dB |
| 1 - 6.5 | ± 0.30 |
| 7 - 8.5 | ± 0.40 |
| 9 - 14 | ± 0.50 |
| 15 - 20 | ± 0.60 |
| 21 - 40 | ± 1.00 |

| MAXIMUM SWR: | |
|-----------------|------|
| Frequency (GHz) | SWR |
| dc - 4 | 1.12 |
| 4 - 8 | 1.15 |
| 8 - 12.4 | 1.18 |
| 12.4 - 18 | 1.20 |

POWER RATING: 5 watts **average** @ 25°C ambient temperature, derated linearly to 0.5 watt @ 125°C. 1 kilowatt **peak** (5 μsec pulse width; 0.25% duty cycle)

POWER COEFFICIENT: <0.005 dB/dB/Watt

TEMPERATURE COEFFICIENT: < 0.0004 dB/dB/°C

TEMPERATURE RANGE: -55°C to +125°C

CONNECTORS: Precision Type N connectors per MIL-STD-348 interface dimensions - mate nondestructively with MIL-C-39012 connectors.

CONSTRUCTION: Stainless steel body and connectors; gold plated beryllium copper contacts.

WEIGHT:

| dB VALUE | WEIGHT (Net) |
|----------------|----------------|
| 1 - 10, 20, 30 | 70 g (2.6 oz) |
| 40 | 100 g (3.6 oz) |

PHYSICAL DIMENSIONS:

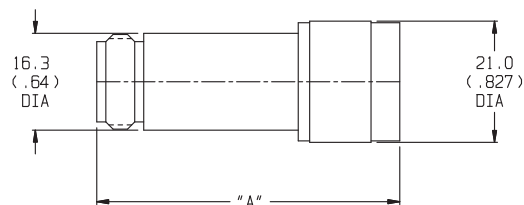

| dB VALUE | DIM A |
|--------------|-------------|
| 1-10, 20, 30 | 57.9 (2.28) |
| 40 | 68.1 (2.68) |

NOTE: All dimensions are given in mm (inches) and are maximum, unless otherwise specified.

Screening

Units are screened as follows:

"N" versions:

- SWR
- Attenuation
- Peak Power

"S" versions:

- Thermal Shock
- Monitored Thermal Cycle (MTC)
- Attenuation
- Conditioning
- Peak Power
- Attenuation
- SWR
- Radiographics

MODEL NUMBER DESCRIPTION:

Example:

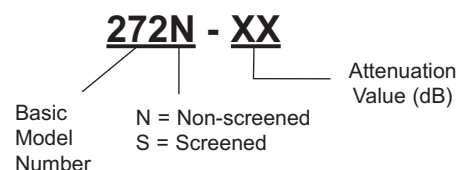

Fixed Coaxial Attenuators



Model 273 High Reliability, SMA Connectors

Designed to meet requirements of MIL-DTL-3933, CLASS III/IV, N/S

dc to 18.0 GHz
2 Watts



Features

- /// Rugged injection molded connectors.
- /// Screened (Model 273S) and Non-screened (Model 273N) designs available.
- /// Available in 0-10 in 0.5 dB steps, 11- 20 in 1 dB steps & 25 - 40 in 5 dB steps.
- /// Test Data supplied at additional cost as follows:
Non-screened (N): Swept data plots of Attenuation and SWR across the frequency band.
Screened (S): Swept data plots of Attenuation and SWR across the frequency band. Film, Standard data package includes lot record performance showing pass/fail quantities for all tests and test reports as applicable.

Specifications

NOMINAL IMPEDANCE: 50 Ω

FREQUENCY RANGE: dc to 18.0 GHz

MAXIMUM DEVIATION OVER FREQUENCY:

| Nominal ATTN (dB) | dB |
|-------------------|--------|
| 1 - 6 | ± 0.30 |
| 7 - 12 | ± 0.50 |
| 20 | ± 0.70 |
| 30, 40 | ± 1.00 |

MAXIMUM SWR:

| Frequency (GHz) | SWR |
|-----------------|------|
| dc - 2 | 1.10 |
| 2 - 4 | 1.15 |
| 4 - 8 | 1.20 |
| 8 - 12.4 | 1.25 |
| 12.4 - 18 | 1.35 |

POWER RATING: 2 watts **average** to 25°C ambient temperature, derated linearly to 0.5 watts at 125°C. 500 watts **peak** (5 μsec pulse width; 0.2% duty cycle).

POWER COEFFICIENT: < 0.005 dB/dB/watts

TEMPERATURE COEFFICIENT: < 0.0004 dB/dB/°C

TEMPERATURE RANGE: -55°C to +125°C

CONNECTORS: SMA connectors per MIL-STD-348 interface dimensions - mate nondestructively with MIL-C-39012 connectors.

CONSTRUCTION: Passivated stainless steel body and connectors; gold plated beryllium copper contacts.

WEIGHT:

| dB VALUE | WEIGHT (Net) |
|------------|-----------------|
| 1 - 19 | 3.9 g (0.14 oz) |
| 20, 25- 29 | 4.3 g (0.15 oz) |
| 30 - 39 | 4.9 g (0.17 oz) |
| 40 | 6.5 g (0.23 oz) |

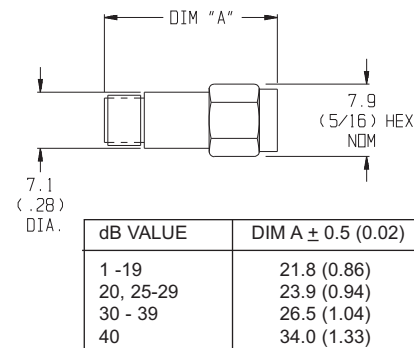

NOTE: All dimensions are given in mm (inches) and are maximum, unless otherwise specified.

Screening

Units are screened as follows:

"N" versions:

- SWR
- Attenuation
- Peak Power

"S" versions:

- Thermal Shock
- Monitored Thermal Cycle (MTC)
- Attenuation w/Parts Assembly Verification (PAV)
- Conditioning
- Peak Power
- Attenuation
- SWR
- Radiographics

MODEL NUMBER DESCRIPTION:

Example:

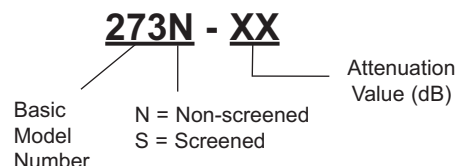

Model 274 High Reliability, SMA Connectors

Designed to meet requirements of MIL-DTL-3933, CLASS III/IV, N/S

dc to 18.0 GHz
2 Watts



RoHS



Features

- /// Rugged injection molded connectors.
- /// Screened (Model 274S) and Non-screened (Model 274N) designs available.
- /// Available in 0 - 20 in 0.5 dB steps, 30 & 40 dB.
- /// Test Data supplied at additional cost as follows:
Non-screened (N): Swept data plots of Attenuation and SWR across the frequency band.
Screened (S): Swept data plots of Attenuation and SWR across the frequency band. Film, Standard data package includes lot record performance showing pass/fail quantities for all tests and test reports as applicable.

Specifications

NOMINAL IMPEDANCE: 50 Ω
FREQUENCY RANGE: dc to 18.0 GHz

| MAXIMUM DEVIATION OVER FREQUENCY: | |
|-----------------------------------|--------|
| Nominal ATTN (dB) | dB |
| 0 - 2 | ± 0.50 |
| 3 - 6 | ± 0.30 |
| 7 - 12 | ± 0.50 |
| 20 | ± 0.70 |
| 30, 40 | ± 1.00 |

| MAXIMUM SWR: | |
|-----------------|------|
| Frequency (GHz) | SWR |
| dc - 4 | 1.15 |
| 4 - 8 | 1.20 |
| 8 - 12.4 | 1.25 |
| 12.4 - 18 | 1.35 |

POWER RATING: 2 watts **average** to 25°C ambient temperature, derated linearly to 0.5 watts at 125°C. 500 watts **peak** (5 μsec pulse width; 0.2% duty cycle).
POWER COEFFICIENT: < 0.005 dB/dB/watts
TEMPERATURE COEFFICIENT: < 0.0004 dB/dB/°C
TEMPERATURE RANGE: -55°C to +125°C

CONNECTORS: SMA connectors per MIL-STD-348 interface dimensions - mate nondestructively with MIL-C-39012 connectors.

CONSTRUCTION: Passivated stainless steel body and connectors; gold plated beryllium copper contacts.

WEIGHT:

| dB VALUE | WEIGHT (Net) |
|----------|----------------|
| 1 - 20 | 10 g (0.35 oz) |
| 30, 40 | 20 g (0.70 oz) |

PHYSICAL DIMENSIONS:

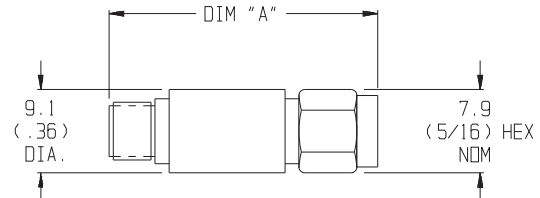

| dB VALUE | DIM A ± 0.5 (0.02) | | |
|------------|--------------------|-------------|-------------|
| | STD | Prefix F | Prefix M |
| 1 - 10, 20 | 30.5 (1.20) | 29.7 (1.17) | 32.3 (1.27) |
| 30, 40 | 47.0 (1.85) | 46.2 (1.82) | 47.7 (1.88) |

NOTE: All dimensions are given in mm (inches) and are maximum, unless otherwise specified.

Screening

Units are screened as follows:

"N" versions:

- SWR
- Attenuation
- Peak Power

"S" versions:

- Thermal Shock
- Monitored Thermal Cycle (MTC)
- Attenuation w/Parts Assembly Verification (PAV)
- Conditioning
- Peak Power
- Attenuation
- SWR
- Radiographics

MODEL NUMBER DESCRIPTION:

Example:

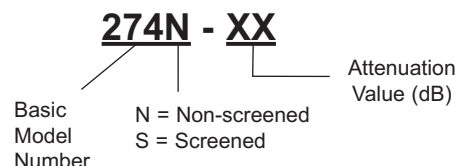

Model 276

High Reliability, N Connectors

Designed to meet requirements of MIL-DTL-3933, CLASS III/IV, N/S

dc to 18.0 GHz
25 Watts



RoHS



Features

- /// Rugged injection molded connectors.
- /// Screened (Model 276S) and Non-screened (Model 276N) designs available.
- /// Available in 3, 6, 10, 20 & 30 dB.
- /// Test Data supplied at additional cost as follows:
Non-screened (N): Swept data plots of Attenuation and SWR across the frequency band.
Screened (S): Swept data plots of Attenuation and SWR across the frequency band. Film, Standard data package includes lot record performance showing pass/fail quantities for all tests and test reports as applicable.

Specifications

NOMINAL IMPEDANCE: 50 Ω

FREQUENCY RANGE: dc to 18.0 GHz

MAXIMUM DEVIATION OVER FREQUENCY:

| Nominal ATTN (dB) | dB |
|-------------------|--------|
| 3, 6 | ± 0.30 |
| 10, 20 | ± 0.50 |
| 30 | ± 1.00 |

MAXIMUM SWR:

| Frequency (GHz) | SWR |
|-----------------|------|
| dc - 4 | 1.15 |
| 4 - 8 | 1.20 |
| 8 - 12 | 1.25 |
| 12 - 18 | 1.40 |

POWER RATING (mounted horizontally): 25 watts average (bi-directional) to 25°C ambient temperature, derated linearly to 2.5 watts @ 125°C. 1 kilowatt peak (5 μsec pulse width; 1.25% duty cycle).

POWER COEFFICIENT: <0.0006 dB/dB/watt

TEMPERATURE COEFFICIENT: <0.0004 dB/dB/°C

TEMPERATURE RANGE: -55°C to 125°C

CONNECTORS: Type N connectors per MIL-STD-348 interface dimensions - mate nondestructively with MIL-C-39012 connectors.

| Options | Description |
|---------|---------------|
| 3 | Type N Female |
| 4 | Type N Male |

CONSTRUCTION: Black, finned aluminum body, stainless steel connectors with gold plated beryllium copper contacts.

WEIGHT: 110 g (4 oz.) maximum

PHYSICAL DIMENSIONS:

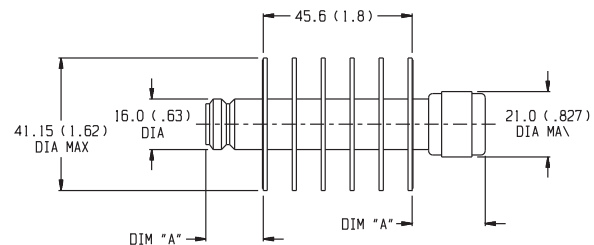

| Connector | DIM A |
|-----------|-------------|
| N Male | 24.1 (0.95) |
| N Female | 19.0 (0.75) |

NOTE: All dimensions are given in mm (inches) and are maximum, unless otherwise specified.

Screening

Units are screened as follows:

"N" versions:

- SWR
- Attenuation
- Peak Power

"S" versions:

- Thermal Shock
- Monitored Thermal Cycle (MTC)
- Attenuation
- Conditioning
- Peak Power
- Attenuation
- SWR
- Radiographics

MODEL NUMBER DESCRIPTION:

Example:

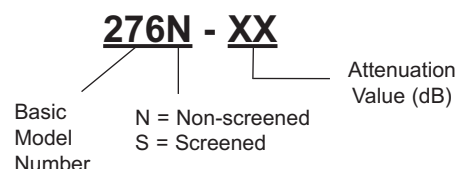

Model 32

High Reliability, SMA Connectors

Suitable for Space & Airborne Applications

dc to 18.0 GHz
2 Watts



Features

- /// Available in 0.5 dB increments from 0-20 dB.
- /// Precision injection molded connectors.
- /// Designed to meet environmental requirements of MIL-DTL-3933.
- /// 100% Subjected to Thermal Shock, Peak Power & Monitored Thermal Cycle (MTC).

Specifications

NOMINAL IMPEDANCE: 50 Ω

FREQUENCY RANGE: dc to 18.0 GHz

MAXIMUM DEVIATION OVER FREQUENCY:

| Nominal ATTN (dB) | Deviation (dB) |
|-------------------|----------------|
| 0 | + 0.30 |
| 0.5 - 6 | ± 0.30 |
| 6.5 - 12 | ± 0.50 |
| 12.5 - 20 | ± 0.70 |

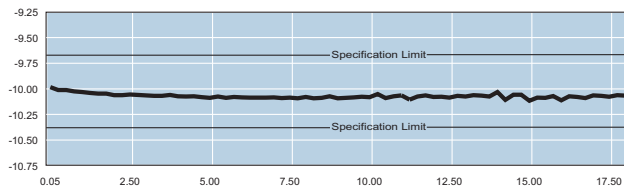

Typical Attenuation Accuracy of 32-10

MAXIMUM SWR:

| Frequency (GHz) | SWR |
|-----------------|------|
| dc - 4 | 1.15 |
| 4 - 8 | 1.20 |
| 8 - 12.4 | 1.25 |
| 12.4 - 18 | 1.35 |

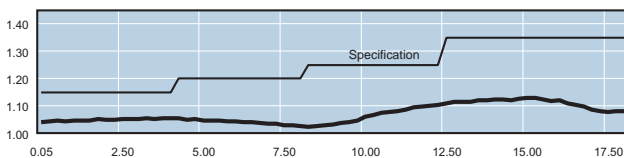

Typical SWR of a 32-10

POWER RATING: 2 watts **average** to 25°C ambient temperature, derated linearly to 0.5 watts at 125°C. 500 watts **peak** (5 μsec pulse width; 0.2% duty cycle).

POWER COEFFICIENT: < 0.005 dB/dB/watts

TEMPERATURE COEFFICIENT: < 0.0004 dB/dB/°C

TEMPERATURE RANGE: -55°C to +125°C

CONNECTORS: SMA connectors per MIL-STD-348 interface dimensions - mate nondestructively with MIL-C-39012 connectors.

CONSTRUCTION: Passivated stainless steel body and connectors; gold plated beryllium copper contacts. Each unit is sealed using low outgassing sealant.

WEIGHT:

| dB VALUE | WEIGHT (Net) |
|-----------|-----------------|
| 0 - 12 | 3.9 g (0.14 oz) |
| 12.5 - 20 | 4.3 g (0.15 oz) |

PHYSICAL DIMENSIONS:

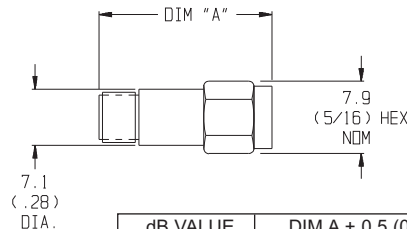

| dB VALUE | DIM A ± 0.5 (0.02) |
|----------|--------------------|
| 0-12 | 21.8 (0.86) |
| 12.5-20 | 23.9 (0.94) |

NOTE: All dimensions are given in mm (inches) and are maximum, unless otherwise specified.

Screening

Units are screened 100% as follows:

Thermal Shock: 10 cycles, -55°C to +100°C

Peak Power: 200 Watts, 5 μsec pulse width; 0.05% duty cycle for 3 minutes at each end. DC Attenuation is measured before and after peak power.

Monitored Thermal Cycle: Units are subjected to 10 thermal cycles between -55 °C to +100 °C. The PIN-to-PIN DC resistance is continuously monitored and stored.

Attenuation and SWR are tested as final electrical test.

MODEL NUMBER DESCRIPTION:

Example:

32 - XX

Basic Model Number

Attenuation Value (dB)

Fixed Coaxial Attenuators



Models 32J High Reliability, SMK Connectors Suitable for Space & Airborne Applications

dc to 32.0 GHz
2 Watts



Features

- /// Available in 0.5 dB increments from 0-30 dB.
- /// Rugged injection molded connectors.
- /// Designed to meet environmental requirements of MIL-DTL-3933.
- /// 100% Subjected to Thermal Shock, Peak Power & Monitored Thermal Cycle (MTC).

Specifications

NOMINAL IMPEDANCE: 50 Ω

FREQUENCY RANGE: dc to 32.0 GHz

MAXIMUM DEVIATION OVER FREQUENCY:

| Nominal ATTN (dB) | Deviation (dB) |
|-------------------|----------------|
| 0 | + 0.5 / -0.0 |
| 0.5 - 12 | ± 0.50 |
| 12.5 - 20 | ± 1.00 |
| 20.5 - 30 | ± 2.00 |

MAXIMUM SWR:

| Frequency (GHz) | SWR |
|-----------------|------|
| dc - 32 | 1.25 |

POWER RATING: 2 watts **average** to 25°C ambient temperature, derated linearly to 0.5 watts at 100°C. 500 watts **peak** (5 μsec pulse width; 0.2% duty cycle).

POWER COEFFICIENT: < 0.005 dB/dB/watts

TEMPERATURE COEFFICIENT: < 0.0004 dB/dB/°C

TEMPERATURE RANGE: -55°C to +100°C

CONNECTORS: SMK (2.92mm) connectors - mate nondestructively with SMA, 3.5mm and SMK (2.92mm) connectors.

CONSTRUCTION: Passivated stainless steel body and connectors; gold plated beryllium copper contacts. Each unit is sealed using low outgassing sealant.

WEIGHT: 13 g (0.46 oz)

PHYSICAL DIMENSIONS:

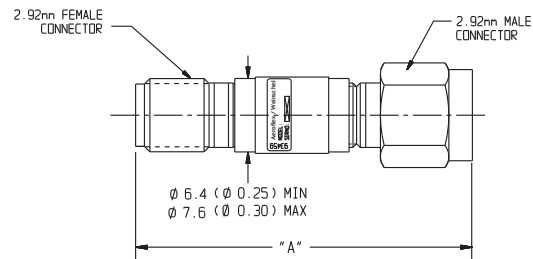

| dB VALUE | DIM A ± 0.5 (0.02) |
|----------|--------------------|
| 0-12 | 28.6 (1.15) |
| 12.5-20 | 31.2 (1.23) |
| 20.5-30 | 33.8 (1.33) |

NOTE: All dimensions are given in mm (inches) and are maximum, unless otherwise specified.

Screening

Units are screened 100% as follows:

Thermal Shock: 10 cycles, -55°C to +100°C

Peak Power: 200 Watts, 5 μsec pulse width; 0.05% duty cycle for 3 minutes at each end. DC Attenuation is measured before and after peak power.

Monitored Thermal Cycle: Units are subjected to 10 thermal cycles between -55 °C to +100 °C. The PIN-to-PIN DC resistance is continuously monitored and stored.

Attenuation and SWR are tested as final electrical test.

MODEL NUMBER DESCRIPTION:

Example:

32J - XX

Basic Model Number Attenuation Value (dB)

EXPORT CONTROL:

This product is controlled for export under the International Traffic in Arms Regulations (ITAR). A license from the U.S. Department of State is required prior to the export of this product from the United States.

EXPORT WARNING:

Aeroflex's military and space products are controlled for export under the International Traffic in Arms Regulations (ITAR) and may not be sold or proposed or offered for sale to certain countries. (See ITAR 126.1 for complete information.)

Model 32K High Reliability, SMK Connectors Suitable for Space & Airborne Applications

dc to 40.0 GHz
2 Watts



Features

- /// Usable to 42 GHz.
- /// Ideal for Space & Airborne Applications.
- /// Available in 3, 6, 10, 20 & 30 dB. Other values available upon request.
- /// Precision injection molded connectors.
- /// Designed to meet environmental requirements of MIL-DTL-3933.
- /// 100% Subjected to Thermal Shock, Peak Power & Monitored Thermal Cycle (MTC).

Specifications

NOMINAL IMPEDANCE: 50 Ω

FREQUENCY RANGE: dc to 40.0 GHz

MAXIMUM DEVIATION OVER FREQUENCY:

| Nominal ATTN (dB) | Deviation (dB) | |
|----------------------|----------------|-------------|
| | dc-26.5 GHz | 26.5-40 GHz |
| 3, 6, 10 | ± 0.50 | ± 1.00 |
| 20, 30 | ± 0.80 | ± 1.50 |

MAXIMUM SWR:

| Frequency (GHz) | SWR |
|-----------------|------|
| dc - 26.5 | 1.25 |
| 26.5 - 40 | 1.45 |

POWER RATING: 2 watts **average** to 25 °C ambient temperature, derated linearly to 0.2 watt at 100 °C. 200 watts **peak** (5 μsec pulse width; 0.5 % duty cycle).

POWER COEFFICIENT: < 0.005 dB/dB/watts

TEMPERATURE COEFFICIENT: < 0.0004 dB/dB/°C

TEMPERATURE RANGE: -55 °C to +100 °C

CONNECTORS: SMK (2.92mm) connectors - mate nondestructively with SMA connectors per MIL-C-39012, 3.5mm and other 2.92mm connectors.

CONSTRUCTION: Passivated stainless steel body and connectors; gold plated beryllium copper contacts. Each unit is sealed using low outgassing sealant.

WEIGHT: 8 g (0.3 oz.) maximum

PHYSICAL DIMENSIONS:

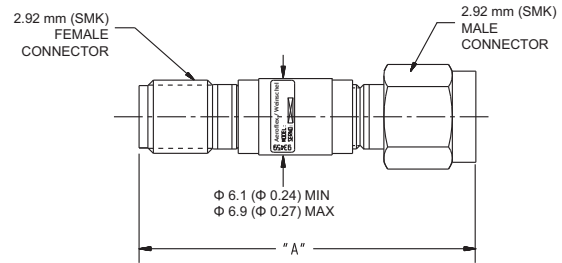

| Model | DIM A |
|-------|---------------------|
| | +/-0.5mm (0.02inch) |
| 32K | 38.0 (1.50) |
| F32K | 36.6 (1.44) |
| M32K | 39.6 (1.56) |

NOTE: All dimensions are given in mm (inches).

Screening

Thermal Shock: 10 cycles, -55 °C to +100 °C

Peak Power: 200 Watts, 5 μsec pulse width; 0.05% duty cycle for 3 minutes at each end. DC Attenuation is measured before and after peak power.

Monitored Thermal Cycle: Units are subjected to 15 thermal cycles between -55 °C to +100 °C. The PIN-to-PIN DC resistance is continuously monitored and stored.

Attenuation and SWR are tested as final electrical test.

MODEL NUMBER DESCRIPTION:

Example:

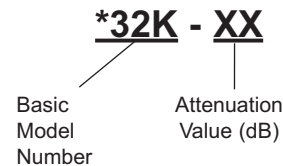

* Add Prefix M for double male and F for double female connectors.

EXPORT CONTROL:

This product is controlled for export under the International Traffic in Arms Regulations (ITAR). A license from the U.S. Department of State is required prior to the export of this product from the United States.

EXPORT WARNING:

Aeroflex's military and space products are controlled for export under the International Traffic in Arms Regulations (ITAR) and may not be sold or proposed or offered for sale to certain countries. (See ITAR 126.1 for complete information.)

Fixed Coaxial Attenuators



Model 41 Medium Power, SMA Connectors Bi-directional Design

dc to 18.0 GHz
10 Watts



Features

- /// **Compact Construction** - Lowest size/power ratio.
- /// **Quality Connectors with special high temperature support beads.**
- /// **Designed to meet environmental requirements of MIL-DTL-3933.**

Specifications

NOMINAL IMPEDANCE: 50 Ω

FREQUENCY RANGE: dc to 18.0 GHz

MAXIMUM DEVIATION OVER FREQUENCY:

| Nominal ATTN (dB) | Deviation (dB) |
|-------------------|----------------|
| 1, 2 | ± 0.50 |
| 3, 6 | ± 0.30 |
| 10 | ± 0.50 |
| 20 | ± 0.70 |
| 30 | ± 1.00 |

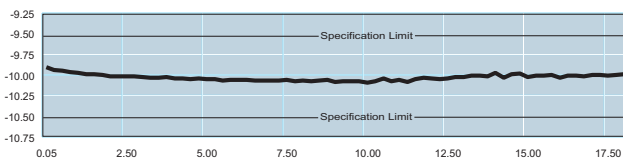

Typical Attenuation Accuracy

MAXIMUM SWR:

| Frequency (GHz) | SWR |
|-----------------|------|
| dc - 8 | 1.20 |
| 8 - 12.4 | 1.30 |
| 12.4 - 18 | 1.35 |

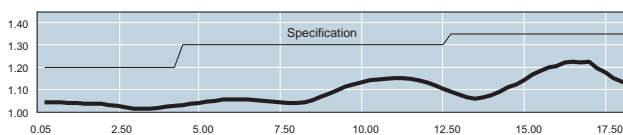

Typical SWR of a 41-10

POWER RATING (mounted horizontally): 10 watts average (bi-directional) to 25°C ambient temperature, derated linearly to 1 Watt @ 125°C. 1 kilowatt peak (5 μsec pulse width; 0.5% duty cycle).

POWER COEFFICIENT: <0.001 dB/dB/watt

TEMPERATURE COEFFICIENT: <0.0004 dB/dB/°C

TEMPERATURE RANGE: -55 °C to 125 °C

TEST DATA: Swept data plots of attenuation and SWR from 50 MHz to 18 GHz.

CONNECTORS: SMA (Male/Female) connectors per MIL-STD-348 interface dimensions - mate nondestructively with MIL-C-39012 connectors.

| Connector Options | Type/Description |
|-------------------|------------------|
| 1 | SMA, Female |
| 2 | SMA, Male |

CONSTRUCTION: Black, finned aluminum body, gold plated beryllium copper contacts.

WEIGHT: 28 g (1 oz.) maximum

PHYSICAL DIMENSIONS:

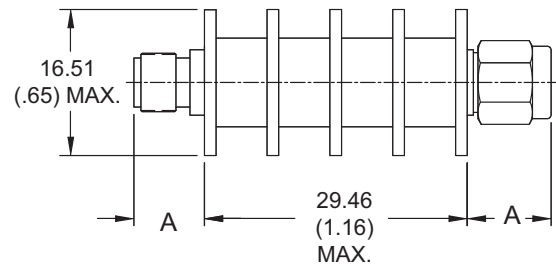

| Connector | DIM A |
|------------|--------------|
| SMA Male | 11.18 (0.44) |
| SMA Female | 9.4 (0.37) |

NOTE: All dimensions are given in mm (inches) and are maximum, unless otherwise specified.

MODEL NUMBER DESCRIPTION:

Example:

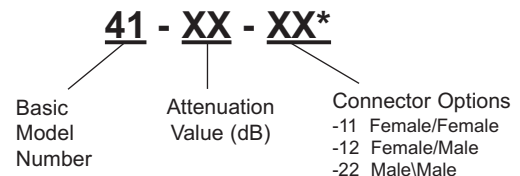

* Unit is bi-directional and full power may be applied to either connector.

Model 37 Medium Power, Type N Connectors Bi-directional Design!

dc to 8.5 GHz
10 Watts

RoHS



Features

- /// Optimized for Wireless OEM & Test Applications.
- /// Precision injection molded connector dielectric.
- /// Designed to meet environmental requirements of MIL-DTL-3933.

Specifications

NOMINAL IMPEDANCE: 50 Ω

FREQUENCY RANGE: dc to 8.5 GHz

MAXIMUM DEVIATION OVER FREQUENCY:

| Nominal ATTN (dB) | Deviation (dB) | |
|----------------------|----------------|-------------|
| | dc-4 GHz | 4 - 8.5 GHz |
| 3, 6, 10, 20 | ± 0.30 | ± 0.50 |
| 30 | ± 0.50 | ± 0.80 |

MAXIMUM SWR:

| Frequency (GHz) | SWR |
|-----------------|------|
| dc - 4 | 1.15 |
| 4 - 8.5 | 1.25 |

POWER RATING (mounted horizontally): 10 watts **average (bi-directional)** to 25°C ambient temperature, derated linearly to 1 watts @ 125°C. Note: 3 dB model can handle 20 Watts **average (bi-directional)**. 1 kilowatt **peak** (5 μsec pulse width; 0.5% duty cycle).

POWER COEFFICIENT: <0.001 dB/dB/watt

TEMPERATURE COEFFICIENT: <0.0004 dB/dB/°C

TEMPERATURE RANGE: -55 °C to 125 °C

TEST DATA: Swept data plots of attenuation and SWR from 50 MHz to 8.5 GHz is available at additional cost.

CONNECTORS: Type N connectors per MIL-STD-348 interface dimensions - mate nondestructively with MIL-C-39012 connectors.

| Connector Options | Type/Description |
|-------------------|------------------|
| 3 | Type N, Female |
| 4 | Type N, Male |

CONSTRUCTION: Black, finned aluminum body, gold plated beryllium copper contacts.

WEIGHT: 110 g (4 oz.) maximum

PHYSICAL DIMENSIONS:

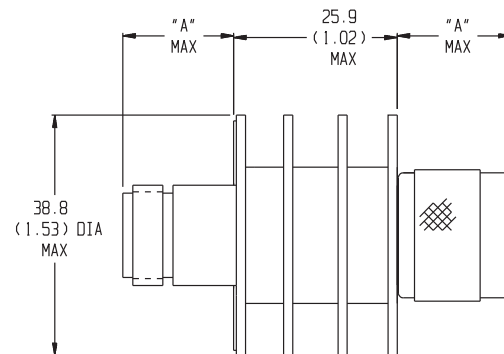

| Connector | DIM A |
|-----------|-------------|
| N Male | 24.1 (0.95) |
| N Female | 19.1 (0.75) |

NOTE: All dimensions are given in mm (inches) and are maximum, unless otherwise specified.

MODEL NUMBER DESCRIPTION:

Example:

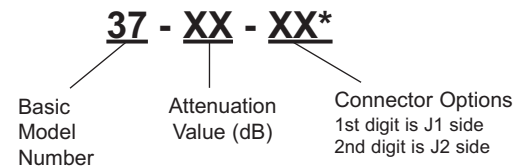

*Unit is bi-directional and full power may be applied to either J1 or J2.

Fixed Coaxial Attenuators



Model 23 Medium Power, Type N Connectors Bi-directional Design!

dc to 18.0 GHz
10 Watts



Features

- /// Precision injection molded connector dielectric.
- /// Designed to meet environmental requirements of MIL-DTL-3933.

Specifications

NOMINAL IMPEDANCE: 50 Ω

FREQUENCY RANGE: dc to 18.0 GHz

MAXIMUM DEVIATION OVER FREQUENCY:

| Nominal ATTN (dB) | Deviation (dB) |
|-------------------|----------------|
| 1, 2 | ± 0.50 |
| 3, 6 | ± 0.30 |
| 10, 20 | ± 0.50 |
| 30, 40 | ± 1.00 |
| 50 | ± 1.25 |
| 60 | ± 1.50 |

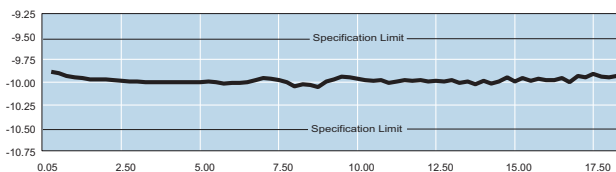

Typical Attenuation Accuracy of a 23-10-34

MAXIMUM SWR:

| Frequency (GHz) | SWR |
|-----------------|------|
| dc - 4 | 1.15 |
| 4 - 8 | 1.20 |
| 8 - 12.4 | 1.25 |
| 12.4 - 18 | 1.35 |

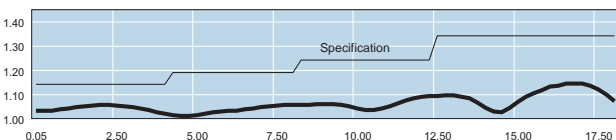

Typical SWR of a 23-10-34

POWER RATING (mounted horizontally): 10 watts average (bi-directional) to 25°C ambient temperature, derated linearly to 1 watts @ 125°C. 1 kilowatt peak (5 μsec pulse width; 0.5% duty cycle).

POWER COEFFICIENT: <0.001 dB/dB/watt

TEMPERATURE COEFFICIENT: <0.0004 dB/dB/°C

TEMPERATURE RANGE: -55°C to 125°C

TEST DATA: Swept data plots of attenuation and SWR from 50 MHz to 18 GHz is available at additional cost.

CONNECTORS: Type N connectors per MIL-STD-348 interface dimensions - mate nondestructively with MIL-C-39012 connectors.

| Connector Options | Type/Description |
|-------------------|------------------|
| 3 | Type N, Female |
| 4 | Type N, Male |

CONSTRUCTION: Black, finned aluminum body, gold plated beryllium copper contacts.

WEIGHT: 110 g (4 oz.) maximum

PHYSICAL DIMENSIONS:

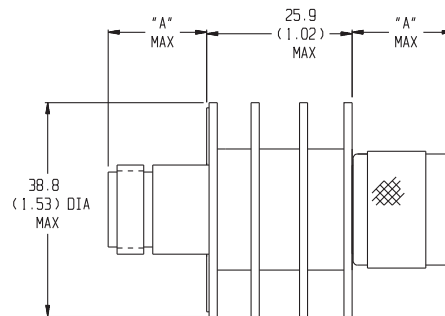

| Connector | DIM A |
|-----------|-------------|
| N Male | 24.1 (0.95) |
| N Female | 19.1 (0.75) |

NOTE: All dimensions are given in mm (inches) and are maximum, unless otherwise specified.

MODEL NUMBER DESCRIPTION:

Example:

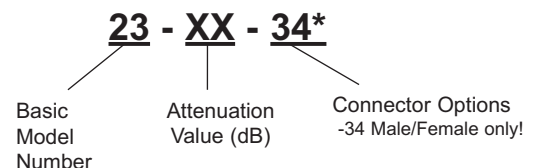

* Unit is bi-directional and full power may be applied to either J1 or J2.

Model 89 Medium Power, SMK Connectors

dc to 40.0 GHz
20 Watts



Features

- /// Compact Construction - Lowest size/power ratio.
- /// Precision injection molded connectors.
- /// Designed to meet environmental requirements of MIL-DTL-3933.

Specifications

NOMINAL IMPEDANCE: 50 Ω

FREQUENCY RANGE: dc to 40.0 GHz

MAXIMUM DEVIATION OVER FREQUENCY:

| Nominal ATTN (dB) | Deviation (dB) |
|-------------------|----------------|
| 10, 20, 30 | ± 1.5 |

MAXIMUM SWR:

| Frequency (GHz) | SWR |
|-----------------|------|
| dc - 18 | 1.25 |
| 18 - 40 | 1.40 |

POWER RATING (mounted horizontally): 20 watts **average (unidirectional)** to 25°C ambient temperature, derated linearly to 2 Watts @ 125°C. 200 watts **peak** (5 μsec pulse width; 5% duty cycle). Maximum power into output port is 5 Watts.

POWER COEFFICIENT: <0.002 dB/dB/watt

TEMPERATURE COEFFICIENT: <0.0004 dB/dB/°C

TEMPERATURE RANGE: -55 °C to 125 °C

TEST DATA: Swept data plots of attenuation and SWR from 50 MHz to 40 GHz.

CONNECTORS: SMK (2.92mm) Male/Female connectors - mate nondestructively with SMA per MIL-C-39012, 3.5mm and other 2.92mm connectors.

| Connector Options | Type/Description |
|-------------------|------------------|
| 1 | 2.92mm, Female |
| 2 | 2.92mm, Male |

CONSTRUCTION: Black, finned aluminum body, gold plated beryllium copper contacts.

WEIGHT: 200 g (8.0 oz.) maximum

PHYSICAL DIMENSIONS:

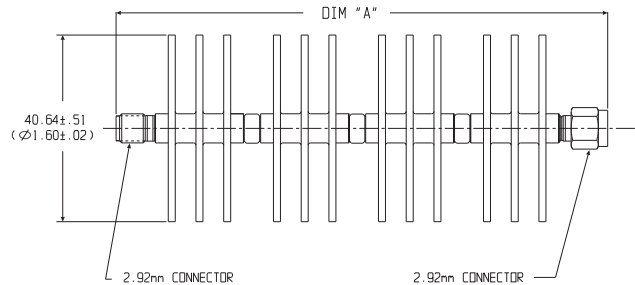

| Dash No. | Connector Type | DIM A |
|----------|----------------------|--------------|
| 11 | 2.92mm Female/Female | 106.2 (4.18) |
| 12 | 2.92mm Female/Male | 109.2 (4.30) |
| 21 | 2.92mm Male/Female | 109.2 (4.30) |
| 22 | 2.92mm Male/Male | 112.0 (4.40) |

NOTE: All dimensions are given in mm (inches) and are nominal, unless otherwise specified.

MODEL NUMBER DESCRIPTION:

Example:

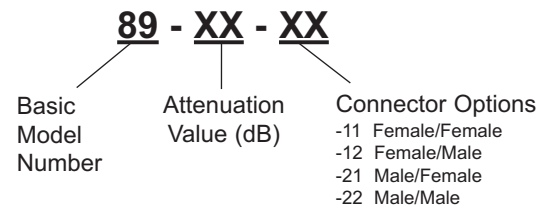

Fixed Coaxial Attenuators



Model 34

Medium Power, Type N or SMK Connectors

dc to 4.0 GHz

25 Watts

Bi-directional Design

RoHS



Features

- /// Optimized for Wireless OEM & Test Applications.
- /// Precision Connectors with high temperature support beads.
- /// Designed to meet environmental requirements of MIL-DTL-3933.

Specifications

NOMINAL IMPEDANCE: 50 Ω

FREQUENCY RANGE: dc to 4.0 GHz

MAXIMUM DEVIATION OVER FREQUENCY:

| Nominal ATTN (dB) | Deviation (dB) | |
|-------------------|----------------|-----------|
| | dc-2 GHz | 2 - 4 GHz |
| 3, 6, 10, 20, 30 | ± 0.60 | ± 1.00 |

MAXIMUM SWR*:

| Frequency (GHz) | SWR |
|-----------------|------|
| dc - 2 | 1.10 |
| 2 - 4 | 1.20 |

POWER RATING (mounted horizontally): 25 watts average (bi-directional) to 25°C ambient temperature, derated linearly to 2.5 watts @ 125°C. 5 kilowatt peak (5 μsec pulse width; 0.25% duty cycle).

POWER COEFFICIENT: <0.0006 dB/dB/watt

TEMPERATURE COEFFICIENT: <0.0004 dB/dB/°C

TEMPERATURE RANGE: -55 °C to 125 °C

TEST DATA: Swept data plots of attenuation and SWR from 50 MHz to 4 GHz is available at additional cost.

Type N connectors per MIL-STD-348 interface dimensions - mate nondestructively with MIL-C-39012 connectors. SMK (2.92mm) connectors - mate nondestructively with SMA per MIL-C-39012, 3.5mm, SMK, and other 2.92mm. Female 2.92mm connector NOT RoHS compliant.

| Options | Description | Options | Description |
|---------|-------------|---------|----------------|
| 1 | SMK Female | 3 | Type N, Female |
| 2 | SMK Male | 4 | Type N, Male |

CONSTRUCTION: Black, finned aluminum body, gold plated beryllium copper contacts.

WEIGHT: 170 g (6 oz.) maximum

PHYSICAL DIMENSIONS:

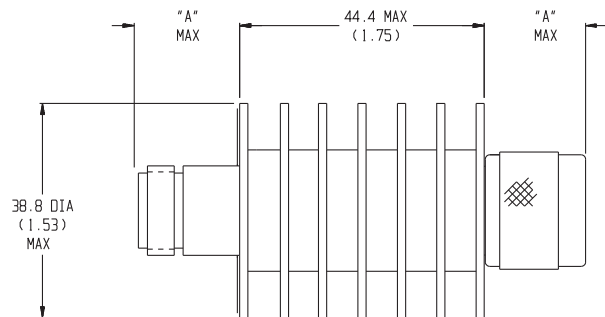

| Connector | DIM A | Connector | DIM A |
|-----------|-------------|---------------|-------------|
| N Male | 22.9 (0.90) | 2.92mm Male | 14.0 (0.55) |
| N Female | 15.0 (0.59) | 2.92mm Female | 12.7 (0.50) |

NOTE: All dimensions are given in mm (inches) and are maximum, unless otherwise specified..

MODEL NUMBER DESCRIPTION:

Example:

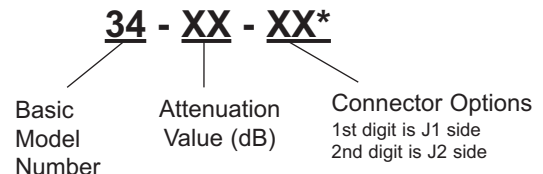

*Unit is bi-directional and full power may be applied to either J1 or J2.

Model 77 Medium Power, 7/16 Connectors

dc to 6.0 GHz
25 Watts



Features

- /// Optimized for Wireless OEM & Test Applications.
- /// Low Intermodulation Design.
- /// Designed to meet environmental requirements of MIL-A-3933.

Specifications

NOMINAL IMPEDANCE: 50 Ω

FREQUENCY RANGE: dc to 6.0 GHz

MAXIMUM DEVIATION OVER FREQUENCY:

| Nominal ATTN (dB) | Deviation (dB) |
|-------------------|----------------|
| 10, 20 | ± 0.70 |
| 30 | ± 1.20 |

MAXIMUM SWR:

| Frequency (GHz) | SWR |
|-----------------|------|
| dc - 3 | 1.20 |
| 3 - 6 | 1.30 |

3rd ORDER INTERMODULATION (77-XX-XX-LIM Only): Reflected Levels (IM3), -100 dBc and Through Levels (IM3), -110 dBc with two input signals @ 869 MHz and 891 MHz with average carrier power levels of +41 dBm each.

POWER RATING (mounted horizontally): 25 watts average (unidirectional) to 25°C ambient temperature, derated linearly to 2.5 watts @ 125°C. Maximum power rating into output is 10 watts average. 5 kilowatt peak (5 μsec pulse width; 0.25% duty cycle).

POWER COEFFICIENT: <0.002 dB/dB/watt

TEMPERATURE COEFFICIENT: <0.0004 dB/dB/°C

TEMPERATURE RANGE: -55 °C to 125 °C

TEST DATA: Swept data plots of SWR from 50 MHz to 6 GHz is available at additional cost.

CONNECTORS: 7/16 connector that conforms to DIN 47223, IEC 169-4, VG 95250, CECC 22 190.

| Connector Options | Type/Description |
|-------------------|------------------|
| 1 | 7/16 Female |
| 2 | 7/16 Male |

CONSTRUCTION: Black, finned aluminum body, silver plated brass connectors

WEIGHT: 280 g (10 oz.) maximum

PHYSICAL DIMENSIONS:

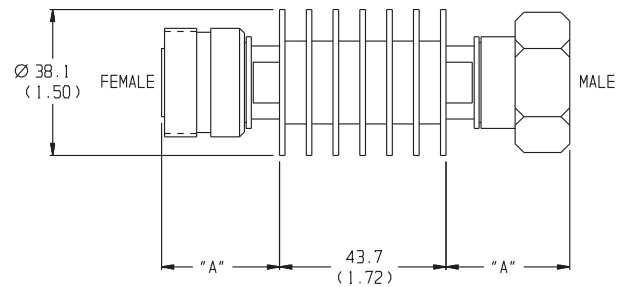

| Connector | DIM A |
|-------------|-------------|
| 7/16 Male | 32.3 (1.27) |
| 7/16 Female | 30.7 (1.21) |

NOTE: All dimensions are given in mm (inches) and tolerances are X.X±0.8 (0.03) unless otherwise specified.

MODEL NUMBER DESCRIPTION:

Example:

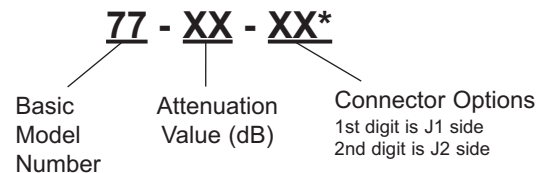

*Unit is bi-directional & full power may be applied to either J1 or J2.

Fixed Coaxial Attenuators



Model 33 Medium Power, N or SMK Connectors Bi-directional Design!

dc to 8.5 GHz
25 Watts
 RoHS



Features

- /// Quality Connectors with special high temperature support beads.
- /// Designed to meet environmental requirements of MIL-DTL-3933.
- /// Low Intermodulation option available.
- /// Mode free operation to 10 GHz.

Specifications

NOMINAL IMPEDANCE: 50 Ω

FREQUENCY RANGE: dc to 8.5 GHz

MAXIMUM DEVIATION OVER FREQUENCY (dB):

| Nominal ATTN (dB) | 33 | | 33-LIM | |
|-------------------|----------|-------------|----------|-------------|
| | dc-4 GHz | 4 - 8.5 GHz | dc-4 GHz | 4 - 8.5 GHz |
| 3, 6 | ± 0.30 | ± 0.60 | --- | --- |
| 10, 20 | ± 0.30 | ± 0.60 | ± 0.40 | ± 0.70 |
| 30 | ± 0.60 | ± 1.00 | ± 0.70 | ± 1.20 |

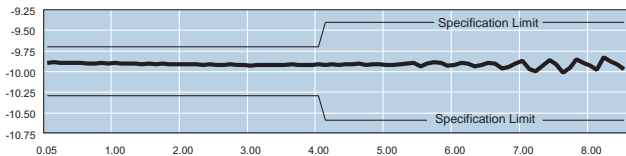

Typical Attenuation Accuracy of a 33-10-34

MAXIMUM SWR:

| Frequency (GHz) | SWR |
|-----------------|------|
| dc - 4 | 1.20 |
| 4 - 8.5 | 1.30 |

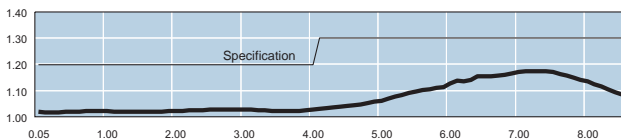

Typical SWR of a 33-10-34

3rd ORDER INTERMODULATION (33-XX-XX-LIM Only): Reflected Levels (IM3), -100 dBc and Through Levels (IM3), -110 dBc with two input signals @ 869 MHz and 891 MHz with average carrier power levels of +41 dBm each.

POWER RATING (mounted horizontally): 25 watts average (bi-directional) to 25°C ambient temperature, derated linearly to 2.5 watts @ 125°C. 5 kilowatt peak (5 μsec pulse width; 0.25% duty cycle).

POWER COEFFICIENT: <0.0006 dB/dB/watt

TEMPERATURE COEFFICIENT: <0.0004 dB/dB/°C

TEMPERATURE RANGE: -55 °C to 125 °C

TEST DATA: Swept data plots of attenuation and SWR from 50 MHz to 8.5 GHz.

CONNECTORS: Type N connectors per MIL-STD-348 interface dimensions - mate nondestructively with MIL-C-39012 connectors. SMK (2.92mm) connectors - mate nondestructively with SMA per MIL-C-39012, 3.5mm, SMK, and other 2.92mm. Female 2.92mm connector NOT RoHS compliant.

| Options | Description | Options | Description |
|---------|-------------|---------|----------------|
| 1 | SMK Female | 3 | Type N, Female |
| 2 | SMK Male | 4 | Type N, Male |

CONSTRUCTION: Black, finned aluminum body, gold plated beryllium copper contacts.

WEIGHT: 170 g (6 oz.) maximum

PHYSICAL DIMENSIONS:

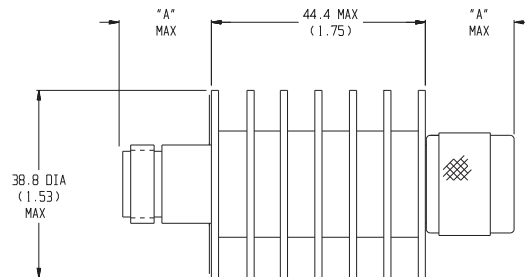

| Connector | DIM A | Connector | DIM A |
|-----------|-------------|---------------|-------------|
| N Male | 22.9 (0.90) | 2.92mm Male | 14.0 (0.55) |
| N Female | 15.0 (0.59) | 2.92mm Female | 12.7 (0.50) |

NOTE: All dimensions are given in mm (inches) and are maximum, unless otherwise specified.

MODEL NUMBER DESCRIPTION:

Example:

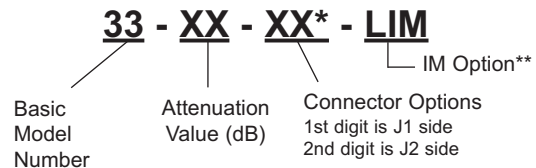

*Unit is bi-directional & full power may be applied to either J1 or J2.

**Add -LIM to entire model number for Low Intermodulation option.

Available in only 10, 20, 30 dB and is not available through Express.

Model 46 Medium Power, N or 3.5mm Connectors Bi-directional Design!

dc to 18.0 GHz
25 Watts



Features

- /// Designed to meet environmental requirements of MIL-DTL-3933.
- /// Rugged injection molded connectors.
- /// Low Intermodulation option available.

Specifications

NOMINAL IMPEDANCE: 50 Ω

FREQUENCY RANGE: dc to 18.0 GHz

| MAXIMUM DEVIATION OVER FREQUENCY: | | | |
|-----------------------------------|--------|------------|-----------|
| Nominal ATTN (dB) | 46 | 46 LIM | |
| | | dc - 8 GHz | 8- 18 GHz |
| 1, 2, 3, 6 | ± 0.50 | --- | --- |
| 10 | ± 0.50 | ± 1.00 | +2.0/-1.0 |
| 20 | ± 0.75 | ± 1.00 | +2.0/-1.0 |
| 30, 40 | ± 1.00 | ± 1.00 | +2.0/-1.0 |

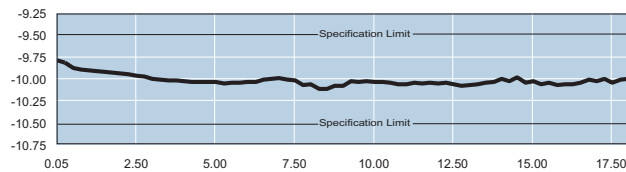

Typical Attenuation Accuracy of a 46-10-34

| MAXIMUM SWR: | |
|-----------------|------|
| Frequency (GHz) | SWR |
| dc - 8 | 1.20 |
| 8 -12.4 | 1.25 |
| 12.4 - 18 | 1.35 |

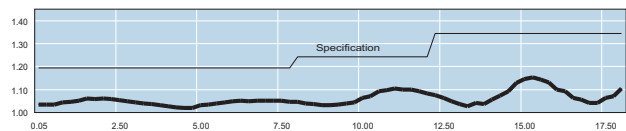

Typical SWR of a 46-10-34

3rd ORDER INTERMODULATION (46-XX-XX-LIM ONLY): Reflected Levels (IM3), -100 dBc and Through Levels (IM3), -110 dBc with two input signals @ 869 MHz and 891 MHz with average carrier power levels of +41 dBm each. Option only available 10, 20, 30, 40 dB.

POWER RATING (mounted horizontally): 25 watts average (bi-directional) to 25°C ambient temperature, derated linearly to 2.5 watts @ 125°C. 1 kilowatt peak (5 μsec pulse width; 1.25% duty cycle).

POWER COEFFICIENT: <0.0006 dB/dB/watt

TEMPERATURE COEFFICIENT: <0.0004 dB/dB/°C

TEMPERATURE RANGE: -55°C to 125°C

TEST DATA: Swept data plots of attenuation and SWR from 50 MHz to 18 GHz.

CONNECTORS: Type N connectors per MIL-STD-348 interface dimensions - mate nondestructively with MIL-C-39012 connectors.

3.5mm Connectors - mate nondestructively with SMA per MIL-C-39012, 2.92mm and other 3.5mm connectors.

| Options | Description | Options | Description |
|---------|--------------|---------|---------------|
| 1 | 3.5mm Female | 3 | Type N Female |
| 2 | 3.5mm Male | 4 | Type N Male |

CONSTRUCTION: Black, finned aluminum body, stainless steel connectors with gold plated beryllium copper contacts.

WEIGHT: 110 g (4 oz.) maximum

PHYSICAL DIMENSIONS:

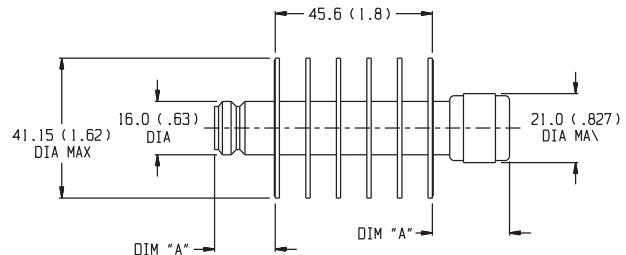

| Connector | DIM A | Connector | DIM A |
|-----------|-------------|--------------|-------------|
| N Male | 24.1 (0.95) | 3.5mm Female | 14.0 (0.55) |
| N Female | 19.0 (0.75) | 3.5mm Male | 13.2 (0.52) |

NOTE: All dimensions are given in mm (inches) and are maximum, unless otherwise specified.

MODEL NUMBER DESCRIPTION:

Example:

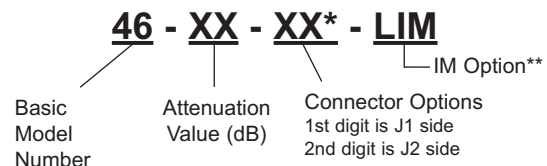

* Unit is bi-directional & full power may be applied to either J1 or J2.

** Add -LIM for Low Intermodulation option. Option only available in 10, 20, 30 and 40 dB and is not available through Express.

Fixed Coaxial Attenuators



Model 74 Medium Power, 3.5mm Connectors

dc to 28.0 GHz
25 Watts



Features

- /// Compact Construction - Lowest size/power ratio.
- /// Precision injection molded connectors.
- /// Designed to meet environmental requirements of MIL-DTL-3933.
- /// Low SWR Design.

Specifications

NOMINAL IMPEDANCE: 50 Ω

FREQUENCY RANGE: dc to 28 GHz

MAXIMUM DEVIATION OVER FREQUENCY:

| Nominal ATTN (dB) | Deviation (dB) |
|-------------------|----------------|
| 3 | ± 0.70 |
| 6, 10 | ± 1.00 |
| 20, 30 | ± 1.50 |

MAXIMUM SWR:

| Frequency (GHz) | SWR |
|-----------------|------|
| dc - 18 | 1.30 |
| 18 - 28 | 1.35 |

POWER RATING: 25 watts **average (unidirectional)** to 25°C ambient temperature, derated linearly to 2.5 Watt @ 125°C. 500 watts **peak** (5 μsec pulse width; 2.5% duty cycle). Maximum power rating into output is 10% of the average power rating.

POWER COEFFICIENT: <0.0006 dB/dB/watt

TEMPERATURE COEFFICIENT: <0.0004 dB/dB/°C

TEMPERATURE RANGE: -55°C to 125°C

TEST DATA: Swept data plots of attenuation and SWR from 50 MHz to 28 GHz. .

CONNECTORS: 3.5mm (Male/Female) connectors - mate nondestructively with SMA per MIL-C-39012, 2.92mm and other 3.5mm connectors.

| Connector Options | Type/Description |
|-------------------|------------------|
| 1 | 3.5mm, Female |
| 2 | 3.5mm, Male |

CONSTRUCTION: Black, finned aluminum body, gold plated beryllium copper contacts.

WEIGHT: 100 g (3.5 oz.) maximum

PHYSICAL DIMENSIONS:

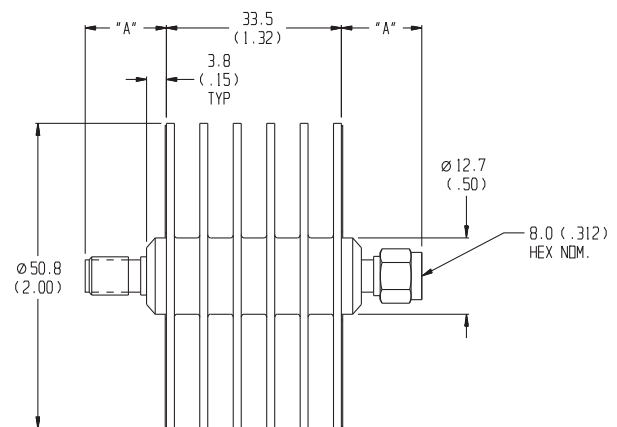

| Connector | DIM A |
|--------------|-------------|
| 3.5mm Male | 16.0 (0.63) |
| 3.5mm Female | 15.0 (0.59) |

NOTE: All dimensions are given in mm (inches) and are maximum, unless otherwise specified.

MODEL NUMBER DESCRIPTION:

Example:

74 - XX - XX

Basic Model Number

Attenuation Value (dB)

Connector Options
1st digit is input side
2nd digit is output side

Model 78 High Power, 7/16 Connectors Bi-Directional Design!

dc to 6.0 GHz
50 Watts



Features

- /// Optimized for Wireless OEM & Test Applications.
- /// Low Intermodulation Design.
- /// Designed to meet environmental requirements of MIL-A-3933.

Specifications

NOMINAL IMPEDANCE: 50 Ω

FREQUENCY RANGE: dc to 6.0 GHz

MAXIMUM DEVIATION OVER FREQUENCY:

| Nominal ATTN (dB) | Deviation (dB) |
|-------------------|----------------|
| 10, 20 | ± 1.00 |
| 30 | ± 1.25 |

MAXIMUM SWR:

| Frequency (GHz) | SWR |
|-----------------|------|
| dc - 3 | 1.20 |
| 3 - 5 | 1.30 |

3rd ORDER INTERMODULATION: Reflected Levels (IM3), -100 dBc and Through Levels (IM3), -110 dBc with two input signals @ 869 MHz and 891 MHz with average carrier power levels of +43 dBm each.

POWER RATING (mounted horizontally): 50 watts average (bi-directional) to 25°C ambient temperature, derated linearly to 10 watts @ 125°C. 5 kilowatt peak (5 μsec pulse width; 0.5 % duty cycle).

POWER COEFFICIENT: <0.00015 dB/dB/watt

TEMPERATURE COEFFICIENT: <0.0004 dB/dB/°C

TEMPERATURE RANGE: -55 °C to 125 °C

TEST DATA: Swept data plots of SWR from 50 MHz to 6 GHz is available at additional cost.

CONNECTORS: 7/16 connector that conforms to DIN 47223, IEC 169-4, VG 95250, CECC 22 190.

| Connector Options | Type/Description |
|-------------------|------------------|
| 1 | 7/16 Female |
| 2 | 7/16 Male |

CONSTRUCTION: Black, finned aluminum body, silver plated brass connectors.

WEIGHT: 392 g (14 oz.) maximum

PHYSICAL DIMENSIONS:

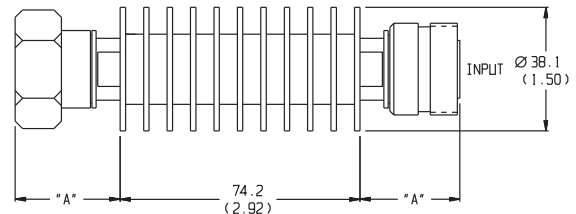

| Connector | DIM A |
|-------------|-------------|
| 7/16 Male | 32.3 (1.27) |
| 7/16 Female | 30.7 (1.21) |

NOTE: All dimensions are given in mm (inches) and tolerances are X.X±0.8 (0.03) unless otherwise specified.

MODEL NUMBER DESCRIPTION:

Example:

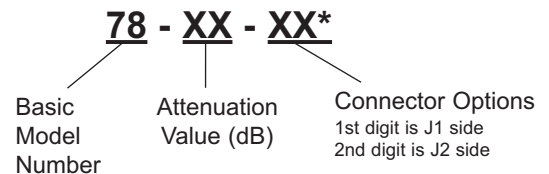

*Unit is bi-directional & full power may be applied to either J1 or J2.

Fixed Coaxial Attenuators



Model 24 Medium Power, N & SMK Connectors Bi-Directional Design!

dc to 8.5 GHz
50 Watts



Features

- Designed to meet environmental requirements of MIL-DTL-3933.
- Low Intermodulation option available.
- Mode free operation to 10 GHz.

Specifications

NOMINAL IMPEDANCE: 50 Ω
FREQUENCY RANGE: dc to 8.5 GHz

| Nominal ATTN (dB) | 24 | | 24-LIM | |
|-------------------|----------|-------------|----------|-------------|
| | dc-4 GHz | 4 - 8.5 GHz | dc-4 GHz | 4 - 8.5 GHz |
| 3, 6, 10, 20 | ± 0.40 | ± 0.75 | ± 0.40 | ± 0.75 |
| 30, 40 | ± 0.60 | ± 0.70 | ± 0.60 | ± 0.70 |

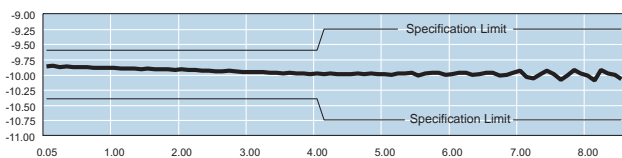

Typical Attenuation Accuracy of a 24-10-34

| Frequency (GHz) | SWR |
|-----------------|------|
| dc - 4 | 1.20 |
| 4 - 8.5 | 1.30 |

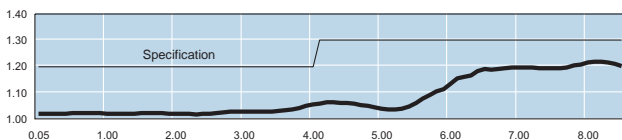

Typical SWR of a 24-10-34

3rd ORDER INTERMODULATION (24-XX-XX-LIM only!): Reflected Levels (IM3), -100 & Through Levels (IM3), -110 dBc with two input signals @ 869 MHz and 891 MHz with average carrier power levels of +43 dBm each.

POWER RATING (mounted horizontally): 50 watts average (bi-directional) to 25°C ambient temperature, derated linearly to 2.5 watts @ 125°C. 5 kilowatt peak (5 µsec pulse width; 0.5% duty cycle).

POWER COEFFICIENT: <0.0003 dB/dB/watt

TEMPERATURE COEFFICIENT: <0.0004 dB/dB/°C

TEMPERATURE RANGE: -55°C to 125°C

TEST DATA: Swept data plots of attenuation and SWR from 50 MHz to 8.5 GHz supplied.

CONNECTORS: Type N connectors per MIL-STD-348 interface dimensions - mate nondestructively with MIL-C-39012 connectors. SMK (2.92mm) connectors - mate nondestructively with SMA per MIL-C-39012, 3.5mm, SMK, and other 2.92mm.

| Options | Descriptions | Options | Descriptions |
|---------|--------------|---------|----------------|
| 1 | SMK, Female | 3 | Type N, Female |
| 2 | SMK, Male | 4 | Type N, Male |

CONSTRUCTION: Black, finned aluminum body, gold plated beryllium copper contacts.

WEIGHT: 171 g (6 oz.) maximum

PHYSICAL DIMENSIONS:

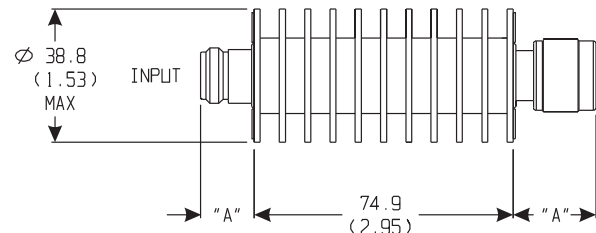

| Connector | DIM A | Connector | DIM A |
|-----------|-------------|------------|-------------|
| N Male | 22.9 (0.90) | SMK Male | 14.0 (0.55) |
| N Female | 15.0 (0.59) | SMK Female | 12.7 (0.50) |

NOTE: All dimensions are given in mm (inches) and are maximum, unless otherwise specified.

MODEL NUMBER DESCRIPTION:

Example:

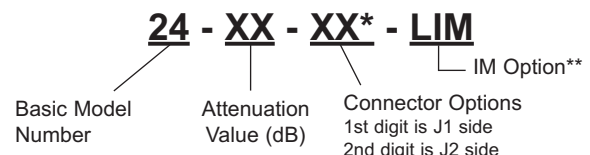

*Unit is bi-directional & full power may be applied to either J1 or J2.

**Add -LIM to entire model number for Low Intermodulation option. Option only available in 10, 20, 30, 40 dB and is not available through Express.

Model 90 Medium Power, N & 3.5mm Connectors Bi-directional Design

dc to 18.0 GHz
50 Watts

RoHS



Features

- /// Precision injection molded connectors.
- /// Designed to meet environmental requirements of MIL-DTL-3933.
- /// Flat Response.
- /// Low Intermodulation option available.

Specifications

NOMINAL IMPEDANCE: 50 Ω

FREQUENCY RANGE: dc to 18.0 GHz

MAXIMUM DEVIATION OVER FREQUENCY:

| Nominal ATTN (dB) | Deviation (dB) | |
|-------------------|----------------|-------------|
| | 90 | 90-LIM |
| 3, 6 | ± 1.0 | --- |
| 10, 20, 30 | ± 1.0 | +2.0 / -1.0 |

MAXIMUM SWR:

| Frequency (GHz) | SWR |
|-----------------|------|
| dc - 8 | 1.15 |
| 8 - 12.4 | 1.20 |
| 12.4 - 18 | 1.30 |

3rd ORDER INTERMODULATION (90-XX-XX-LIM ONLY): Reflected Levels (IM3), -100 dBc and Through Levels (IM3), -110 dBc with two input signals @ 869 MHz and 891 MHz with average carrier power levels of +43 dBm each. Option only available 10, 20, 30 dB.

POWER RATING (mounted horizontally): 50 watts average (bi-directional) to 25°C ambient temperature, derated linearly to 5 Watts @ 125°C. 1 kW peak (5 μsec pulse width; 2.5% duty cycle).

POWER COEFFICIENT: <0.0003 dB/dB/watt

TEMPERATURE COEFFICIENT: <0.0004 dB/dB/°C

TEMPERATURE RANGE: -55 °C to 125 °C

TEST DATA: Swept data plots of attenuation and SWR from 50 MHz to 18 GHz. Frequency markers at 0.05, 2.0, 4.0, 8.0, 12.4, 18.0 GHz

CONNECTORS: Type N connectors per MIL-STD-348 interface dimensions - mate nondestructively with MIL-C-39012 connectors.

3.5mm Connectors - mate nondestructively with SMA per MIL-C-39012, 2.92mm and 3.5mm connectors.

| Options | Description | Options | Description |
|---------|--------------|---------|----------------|
| 1 | 3.5mm Female | 3 | Type N, Female |
| 2 | 3.5mm Male | 4 | Type N, Male |

CONSTRUCTION: Black, finned aluminum body, gold plated beryllium copper contacts.

WEIGHT: 120 g (4.2 oz.) maximum

PHYSICAL DIMENSIONS:

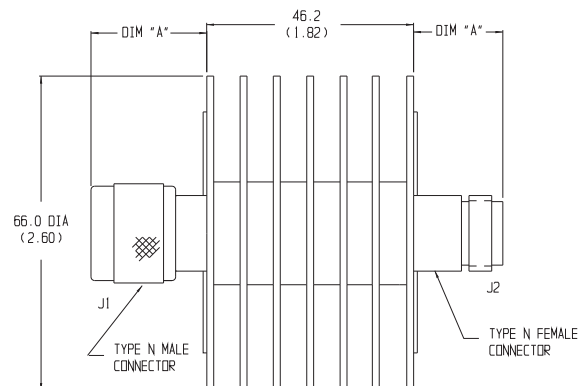

| Connector | DIM A | Connector | DIM A |
|-----------|-------------|--------------|-------------|
| N Male | 24.1 (0.95) | 3.5mm Male | 14.0 (0.55) |
| N Female | 19.0 (0.75) | 3.5mm Female | 13.2 (0.52) |

NOTE: All dimensions are given in mm (inches) and are maximum, unless otherwise specified.

MODEL NUMBER DESCRIPTION:

Example:

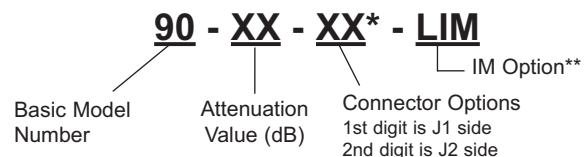

* Unit is bi-directional & full power may be applied to either J1 or J2.

**Add -LIM to entire model number for Low Intermodulation option. Option only available in 10, 20, 30 dB.

Fixed Coaxial Attenuators



Model 47 Medium Power, N or 3.5mm Connectors

dc to 18.0 GHz
50 Watts

RoHS



Features

- Designed to meet environmental requirements of MIL-DTL-3933.
- Rugged injection molded connectors.

Specifications

NOMINAL IMPEDANCE: 50 Ω

FREQUENCY RANGE: dc to 18.0 GHz

MAXIMUM DEVIATION OVER FREQUENCY:

| Nominal ATTN (dB) | Deviation (dB) |
|-------------------|----------------|
| 3, 6 | ± 0.75 |
| 10, 20 | ± 0.75 |
| 30, 40 | ± 1.00 |

MAXIMUM SWR:

| Frequency (GHz) | 3, 6 dB | 10, 20, 30, 40 dB |
|-----------------|---------|-------------------|
| dc - 8 | 1.25 | 1.20 |
| 8 -12.4 | 1.35 | 1.25 |
| 12.4 - 18 | 1.45 | 1.35 |

POWER RATING (mounted horizontally): 50 watts average (unidirectional) to 25°C ambient temperature, derated linearly to 5 watts @ 125°C. Note: 3 dB model can handle 100 Watts average (unidirectional). 1 kilowatt peak (5 μsec pulse width; 2.5% duty cycle). Maximum power rating into output port is 10 Watts average.

POWER COEFFICIENT: <0.0003 dB/dB/watt

TEMPERATURE COEFFICIENT: <0.0004 dB/dB/°C

TEMPERATURE RANGE: -55°C to 125°C

TEST DATA: Swept data plots of attenuation and SWR from 50 MHz to 18 GHz.

CONNECTORS: Type N connectors per MIL-STD-348 interface dimensions - mate nondestructively with MIL-C-39012 connectors.

3.5mm Connectors - mate nondestructively with SMA per MIL-C-39012, 2.92mm and other 3.5mm connectors.

| Options | Description | Options | Description |
|---------|--------------|---------|---------------|
| 1 | 3.5mm Female | 3 | Type N Female |
| 2 | 3.5mm Male | 4 | Type N Male |

CONSTRUCTION: Black, finned aluminum body, stainless steel connectors with gold plated beryllium copper contacts.

WEIGHT: 175 g (6 oz.) maximum

PHYSICAL DIMENSIONS:

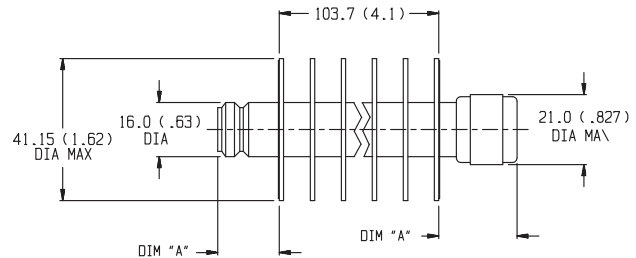

| Connector | DIM A | Connector | DIM A |
|-----------|-------------|--------------|-------------|
| N Male | 24.1 (0.95) | 3.5mm Female | 14.0 (0.55) |
| N Female | 19.0 (0.75) | 3.5mm Male | 13.2 (0.52) |

NOTE: All dimensions are given in mm (inches) and are maximum, unless otherwise specified.

MODEL NUMBER DESCRIPTION:

Example:

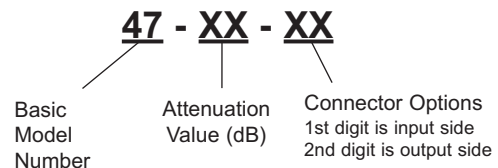

Model 68 High Power, N or SMK Connectors Convection Cooled

dc to 4.0 GHz
100 Watts



Features

- /// Precision Connectors with high temperature support beads.
- /// Designed to meet environmental requirements of MIL-DTL-3933.
- /// 10 Kilowatts peak, Convection Cooled
- /// Wireless Applications - Optimized for use in the communications bands.

Specifications

NOMINAL IMPEDANCE: 50 Ω
FREQUENCY RANGE: dc to 4.0 GHz

| MAXIMUM DEVIATION OVER FREQUENCY: | |
|-----------------------------------|----------------|
| Nominal ATTN (dB) | Deviation (dB) |
| 1, 2 | ± 0.50 |
| 3, 6, 10, 20, 30 | ± 1.00 |
| 40 | ± 2.00 |

| MAXIMUM SWR: | |
|-----------------|------|
| Frequency (GHz) | SWR |
| dc - 4 | 1.20 |

PHYSICAL DIMENSIONS:

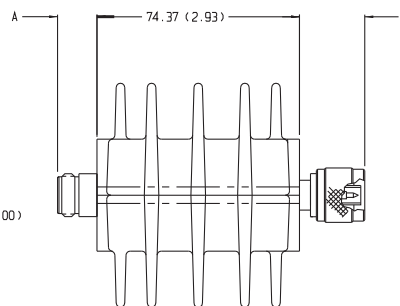
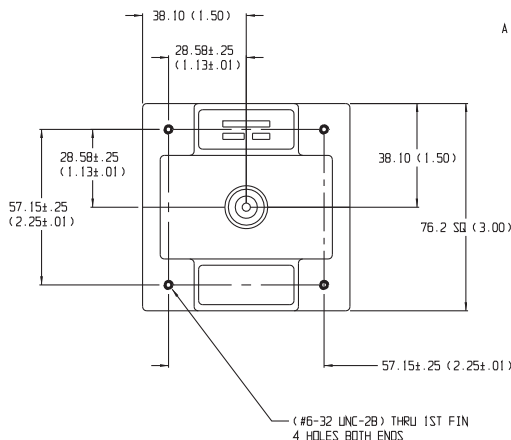

| Connector | DIM A | Connector | DIM A |
|-----------|-------------|---------------|-------------|
| N Male | 22.9 (0.90) | 2.92mm Male | 14.0 (0.55) |
| N Female | 15.0 (0.59) | 2.92mm Female | 12.7 (0.50) |

POWER RATING (mounted horizontally): 100 watts average (unidirectional) to 25°C ambient temperature, derated linearly to 10 watts @ 125°C. 10 kilowatts peak (5 μsec pulse width; 0.5% duty cycle). Maximum power rating into output port is 10% of the average power rating.

POWER COEFFICIENT: <0.00015 dB/dB/watt

TEMPERATURE COEFFICIENT: <0.0004 dB/dB/°C

TEMPERATURE RANGE: -55°C to 100°C

TEST DATA: Swept data plots of attenuation and SWR from 50 MHz to 4 GHz is available at additional cost.

CONNECTORS: Type N connectors per MIL-STD-348 interface dimensions - mate nondestructively with MIL-C-39012 connectors. SMK (2.92mm) connectors - mate nondestructively with SMA per MIL-C-39012, 3.5mm, SMK, and other 2.92mm connectors.

| Options | Description | Options | Description |
|---------|-------------|---------|----------------|
| 1 | SMK, Female | 3 | Type N, Female |
| 2 | SMK, Male | 4 | Type N, Male |

CONSTRUCTION: Aluminum alloy body, stainless steel connectors; gold plated beryllium copper contacts.

WEIGHT: 500 g (18 oz.) maximum

MODEL NUMBER DESCRIPTION:

Example:

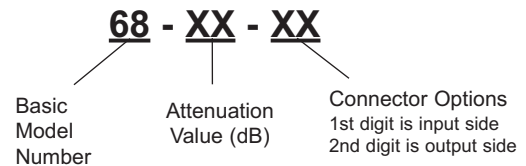

NOTE: All dimensions are given in mm (inches) and are maximum, unless otherwise specified.

Fixed Coaxial Attenuators



Model 73 High Power, N or SMK Connectors

dc to 8.5 GHz
100 Watts

RoHS



Features

- /// **Compact Construction** - Lowest size/power ratio.
- /// **Quality connectors with special high temperature support beads.**
- /// **Designed to meet environmental requirements of MIL-DTL-3933.**

Specifications

NOMINAL IMPEDANCE: 50 Ω
FREQUENCY RANGE: dc to 8.5 GHz

| MAXIMUM DEVIATION OVER FREQUENCY: | |
|-----------------------------------|----------------|
| Nominal ATTN (dB) | Deviation (dB) |
| 3, 6, 10, 20, 30 | ± 0.75 |
| 40 | +1 / -0.50 |

| MAXIMUM SWR: | |
|-----------------|------|
| Frequency (GHz) | SWR |
| dc - 4 | 1.25 |
| 4 - 8.5 | 1.35 |

PHYSICAL DIMENSIONS:

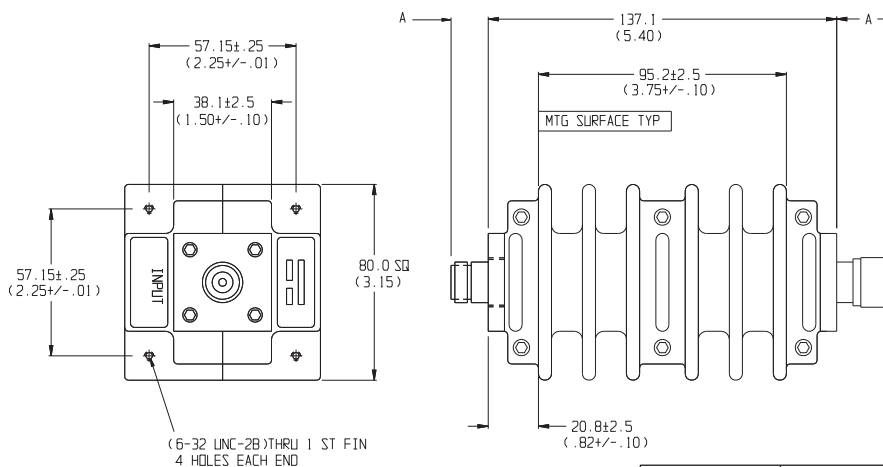

NOTE: All dimensions are given in mm (inches) and are maximum, unless otherwise specified.

POWER RATING (mounted horizontally with fins vertical): 100 watts average (unidirectional) to 25°C ambient temperature, derated linearly to 10 watts @ 125°C. 5 kilowatt peak (5 μsec pulse width; 1.0% duty cycle). Maximum power rating into output port is 20 watts average.

POWER COEFFICIENT: <0.00015 dB/dB/watt

TEMPERATURE COEFFICIENT: <0.0004 dB/dB/°C

TEMPERATURE RANGE: -55°C to 125°C

TEST DATA: Swept data plots of SWR from 50 MHz to 8.5 GHz.

CONNECTORS: Type N connectors per MIL-STD-348 interface dimensions - mate nondestructively with MIL-C-39012 connectors. SMK (2.92mm) connectors - mate nondestructively with SMA per MIL-C-39012, 3.5mm, SMK, and other 2.92mm connectors.

| Options | Description | Options | Description |
|---------|-------------|---------|----------------|
| 1 | SMK, Female | 3 | Type N, Female |
| 2 | SMK, Male | 4 | Type N, Male |

CONSTRUCTION: Aluminum alloy body, stainless steel connectors; gold plated beryllium copper contacts.

WEIGHT: 1130 g (2 lbs, 8 oz.) maximum

MODEL NUMBER DESCRIPTION:

Example:

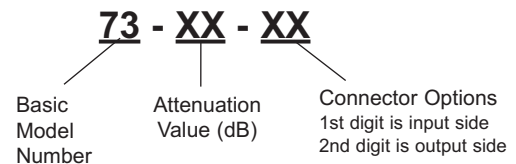

| Connector | DIM A | Connector | DIM A |
|-----------|-------------|---------------|-------------|
| N Male | 22.9 (0.90) | 2.92mm Male | 14.0 (0.55) |
| N Female | 15.0 (0.59) | 2.92mm Female | 12.7 (0.50) |

Model 260 High Power, N or 3.5mm Connectors

dc to 18.0 GHz
100 Watts

RoHS



Features

- /// Designed to meet environmental requirements of MIL-DTL-3933.
- /// Low Intermodulation option available.
- /// Rugged injection molded connectors.

Specifications

NOMINAL IMPEDANCE: 50 Ω
FREQUENCY RANGE: dc to 18.0 GHz

MAXIMUM DEVIATION OVER FREQUENCY:

| Nominal ATTN (dB) | 260 | 260 LIM |
|-------------------|--------|------------|
| 6 | ± 0.75 | --- |
| 10, 20 | ± 0.75 | +2.0/-0.75 |
| 30 | ± 1.00 | +2.0/-0.75 |

MAXIMUM SWR:

| Frequency (GHz) | 6 dB | 10, 20, 30 dB |
|-----------------|------|---------------|
| dc - 8 | 1.25 | 1.20 |
| 8 - 12.4 | 1.35 | 1.25 |
| 12.4 - 18 | 1.45 | 1.35 |

3rd ORDER INTERMODULATION (260-XX-XX-LIM ONLY): Reflected Levels (IM3), -100 & Through Levels (IM3), -110 dBc with two input signals @ 869 MHz and 891 MHz with average carrier power levels of +43 dBm each. Option only available 10, 20, 30 dB.

POWER RATING (mounted horizontally): 100 watts average (unidirectional) to 25°C ambient temperature, derated linearly to 10 watts @ 125°C. 1 kilowatt peak (5 µsec pulse width; 5% duty cycle). Maximum power rating into output port is 20 Watts average.

POWER COEFFICIENT: <0.00015 dB/dB/watt

TEMPERATURE COEFFICIENT: <0.0004 dB/dB/°C

TEMPERATURE RANGE: -55°C to 125°C

TEST DATA: Swept data plots of attenuation and SWR from 50 MHz to 18 GHz.

CONNECTORS: Type N connectors per MIL-STD-348 interface dimensions - mate nondestructively with MIL-C-39012 connectors. 3.5mm connectors - mate nondestructively with SMA per MIL-C-39012, 3.5mm, SMK, and other 2.92mm connectors.

| Options | Description | Options | Description |
|---------|--------------|---------|---------------|
| 1 | 3.5mm Female | 3 | Type N Female |
| 2 | 3.5mm Male | 4 | Type N Male |

CONSTRUCTION: Black, finned aluminum body, stainless steel connectors with gold plated beryllium copper contacts.

WEIGHT: 340 g (12.0 oz.) maximum

PHYSICAL DIMENSIONS:

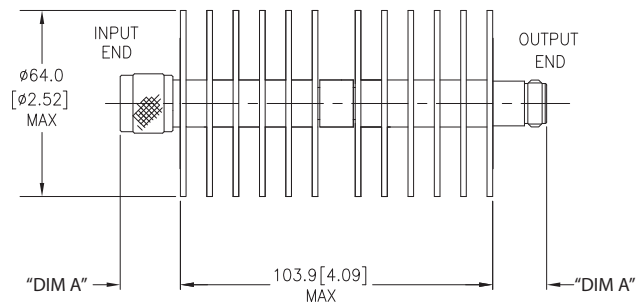

| Connector | DIM A | Connector | DIM A |
|-----------|-------------|--------------|-------------|
| N Male | 24.1 (0.95) | 3.5mm Female | 14.0 (0.55) |
| N Female | 19.0 (0.75) | 3.5mm Male | 13.2 (0.52) |

NOTE: All dimensions are given in mm (inches) and are maximum, unless otherwise specified.

MODEL NUMBER DESCRIPTION:

Example:

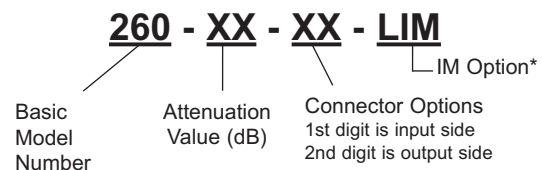

* Add -LIM for Low Intermodulation option. Option only available in 10, 20, and 30 dB.

Fixed Coaxial Attenuators



Model 48 High Power, N & 3.5mm Connectors

dc to 18.0 GHz
100 Watts

RoHS



Features

- Designed to meet environmental requirements of MIL-DTL-3933.
- Rugged injection molded connectors.

Specifications

NOMINAL IMPEDANCE: 50 Ω

FREQUENCY RANGE: dc to 18.0 GHz

MAXIMUM DEVIATION OVER FREQUENCY:

| Nominal ATTN (dB) | Deviation (dB) |
|-------------------|----------------|
| 6 | ± 2.00 |
| 10 | ± 2.00 |
| 20, 30, 40 | ± 1.00 |

MAXIMUM SWR:

| Frequency (GHz) | 6 dB | 10 dB | 20, 30, 40 dB |
|-----------------|------|-------|---------------|
| dc - 8 | 1.30 | 1.40 | 1.25 |
| 8 - 12.4 | 1.45 | 1.40 | 1.35 |
| 12.4 - 18 | 1.60 | 1.55 | 1.45 |

POWER RATING (mounted horizontally): 100 watts average (unidirectional) to 25°C ambient temperature, derated linearly to 10 watts @ 125°C. 1 kilowatt peak (5 μsec pulse width; 5% duty cycle). Maximum power rating into output port is 10 Watts average.

POWER COEFFICIENT: <0.00015 dB/dB/watt

TEMPERATURE COEFFICIENT: <0.0004 dB/dB/°C

TEMPERATURE RANGE: -55°C to 125°C

TEST DATA: Swept data plots of attenuation and SWR from 50 MHz to 18 GHz.

CONNECTORS: Type N connectors per MIL-STD-348 interface dimensions - mate nondestructively with MIL-C-39012 connectors.

3.5mm (Male/Female) connectors - mate nondestructively with SMA per MIL-C-39012, 2.92mm and other 3.5mm connectors.

| Connector Options | Type/Description |
|-------------------|------------------|
| 1 | 3.5mm, Female |
| 2 | 3.5mm, Male |
| 3 | Type N, Female |
| 4 | Type N, Male |

CONSTRUCTION: Black, finned aluminum body, stainless steel connectors, gold plated beryllium copper contacts.

WEIGHT: 383 g (13.5 oz.) maximum

PHYSICAL DIMENSIONS:

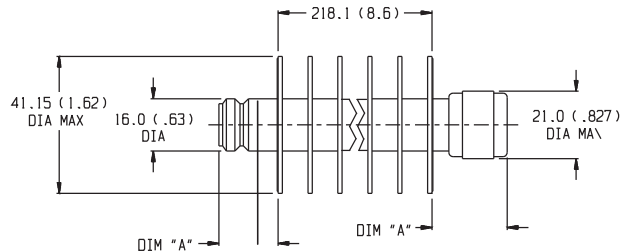

| Connector | DIM A |
|--------------|-------------|
| 3.5mm Female | 13.2 (0.52) |
| 3.5mm Male | 14.0 (0.55) |
| N Male | 24.1 (0.95) |
| N Female | 19.0 (0.75) |

NOTE: All dimensions are given in mm (inches) and are maximum, unless otherwise specified.

MODEL NUMBER DESCRIPTION:

Example:

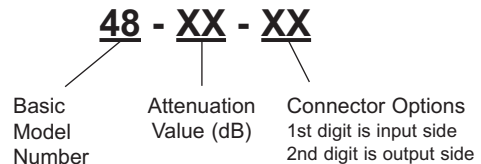

Model 40

Model 57

High Power, N or SMK Connectors

Fixed Coaxial Attenuators

dc to 1.5 GHz

dc to 6.0 GHz

150 Watts

RoHS



Features

- /// Quality connectors with special high temperature support beads.
- /// Designed to meet environmental requirements of MIL-DTL-3933.

Specifications

NOMINAL IMPEDANCE: 50 Ω

FREQUENCY RANGE: Model 40: dc to 1.5 GHz
Model 57: dc to 6.0 GHz

| MAXIMUM DEVIATION OVER FREQUENCY: | | | |
|-----------------------------------|----------------|--------|--------|
| Nominal ATTN (dB) | Deviation (dB) | | |
| | 40 | 57 | 57-LIM |
| 3 | ± 0.50 | ± 1.25 | --- |
| 6, 10 | ± 0.50 | ± 1.25 | ± 1.75 |
| 20, 30 | ± 0.50 | ± 1.50 | ± 2.00 |
| 40 | ± 0.50 | ± 2.00 | ± 2.00 |

| MAXIMUM SWR: | | |
|-----------------|-------|--------|
| Frequency (GHz) | Input | Output |
| dc - 2 (1.5*) | 1.10 | 1.10 |
| 2 - 6 | 1.15 | 1.20 |

* Model 40 only!

3rd ORDER INTERMODULATION (57-XX-XX-LIM ONLY): Reflected Levels (IM3), -100 & Through Levels (IM3), -110 dBc with two input signals @ 869 MHz and 891 MHz with average carrier power levels of +43 dBm each. Option only available 6, 10, 20, 30, 40 dB.

PHYSICAL DIMENSIONS:

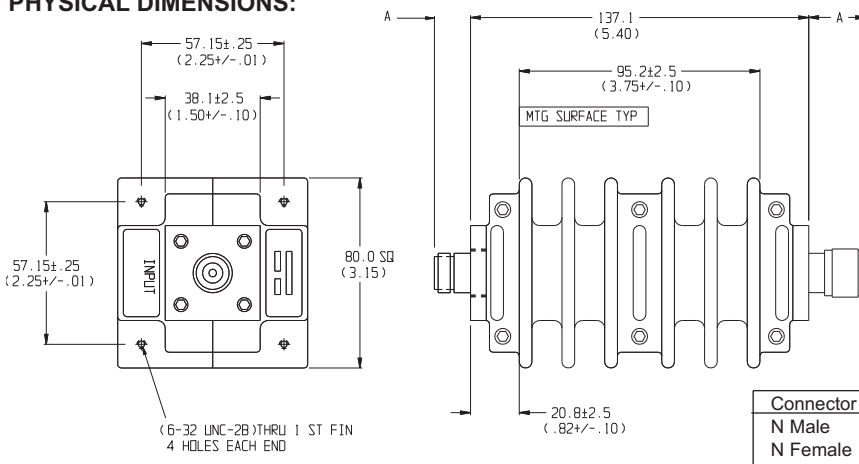

NOTE: All dimensions are given in mm (inches) and are maximum, unless otherwise specified.

| Connector | DIM A | Connector | DIM A |
|-----------|-------------|---------------|-------------|
| N Male | 22.9 (0.90) | 2.92mm Male | 14.0 (0.55) |
| N Female | 15.0 (0.59) | 2.92mm Female | 12.7 (0.50) |

POWER RATING (mounted horizontally with fins vertical): 150 watts **average** (unidirectional) to 25°C ambient temperature, derated linearly to 15 watts @ 125°C. 10 kilowatt **peak** (5 μsec pulse width; 0.75% duty cycle). Maximum power rating into output port is 20 watts average.

POWER COEFFICIENT: <0.0001 dB/dB/watt

TEMPERATURE COEFFICIENT: <0.0004 dB/dB/°C

TEMPERATURE RANGE: -55°C to 125°C

TEST DATA: Swept data plots of attenuation and SWR from 50 MHz to 1,5 / 6 GHz.

CONNECTORS: Type N connectors per MIL-STD-348 interface dimensions - mate nondestructively with MIL-C-39012 connectors. SMK (2.92mm) connectors - mate nondestructively with SMA per MIL-C-39012, 3.5mm, SMK, and other 2.92mm connectors.

| Options | Description | Options | Description |
|---------|-------------|---------|---------------|
| 1 | SMK Female | 3 | Type N Female |
| 2 | SMK Male | 4 | Type N Male |

CONSTRUCTION: Aluminum alloy body, stainless steel connectors; gold plated beryllium female copper contacts and stainless steel male contacts.

WEIGHT: 1,130 g (2 lbs, 8 oz.) maximum

MODEL NUMBER DESCRIPTION:

Example:

57 - XX - XX - LIM
IM Option*

Basic Model Number: 57
Attenuation Value (dB): XX
Connector Options: XX
1st digit is input side
2nd digit is output side

* Add -LIM for Low Intermodulation option. Option only available with Model 57 in 6, 10, 20, 30, 40 dB and is not available through Express.

Fixed Coaxial Attenuators



Model 65 High Power, N or SMK Connectors Conduction/Convection Cooled

dc to 2.5 GHz
150 Watts



Features

- /// **Compact Construction** - Lowest size/power ratio.
- /// **Flexible Mounting Position** - The units may be mounted in horizontal (fins up) or vertical position.
- /// **Rugged Construction** - Quality connectors with special high temperature support beads.

Specifications

NOMINAL IMPEDANCE: 50 Ω

FREQUENCY RANGE: dc to 2.5 GHz

MAXIMUM DEVIATION OVER FREQUENCY:

| Nominal ATTN (dB) | Deviation (dB) |
|-------------------|----------------|
| 3, 6, 10, 20, 30 | ± 1.00 |

MAXIMUM SWR:

| Frequency (GHz) | SWR |
|-----------------|------|
| dc - 2.5 | 1.20 |

PHYSICAL DIMENSIONS:

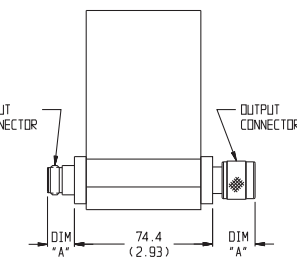
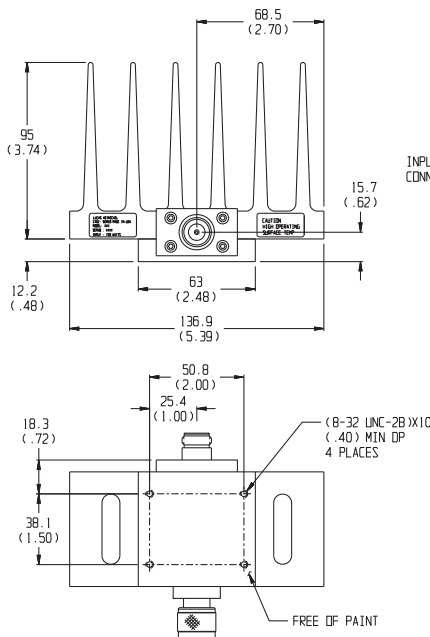

| Connector | DIM A | Connector | DIM A |
|-----------|-------------|---------------|-------------|
| N Male | 22.9 (0.90) | 2.92mm Male | 14.0 (0.55) |
| N Female | 15.0 (0.59) | 2.92mm Female | 12.7 (0.50) |

NOTE: All dimensions are given in mm (inches) and are maximum, unless otherwise specified.

POWER RATING 150 watts **average** (unidirectional), 10 kilowatts **peak** (5 μsec pulse width; 0.75 % duty cycle) with case temperature held within **100 °C maximum** with appropriate convection cooling and/or conductive heat sink. Maximum power rating into output port is 20 watts average.

POWER COEFFICIENT: <0.0001 dB/dB/watt

TEMPERATURE COEFFICIENT: <0.0004 dB/dB/°C

TEMPERATURE RANGE: -55°C to 100°C (case temp.)

TEST DATA: Swept data plots of attenuation and SWR from 50 MHz to 2.5 GHz.

CONNECTORS: Type N connectors per MIL-STD-348 interface dimensions - mate nondestructively with MIL-C-39012 connectors. SMK (2.92mm) connectors - mate nondestructively with SMA per MIL-C-39012, 3.5mm, SMK, and other 2.92mm connectors.

| Options | Description | Options | Description |
|---------|-------------|---------|---------------|
| 1 | SMK Female | 3 | Type N Female |
| 2 | SMK Male | 4 | Type N Male |

CONSTRUCTION: Aluminum alloy body, stainless steel connectors; gold plated beryllium copper contacts.

WEIGHT: 850 g (1 lbs., 14 oz.) maximum

MODEL NUMBER DESCRIPTION:

Example:

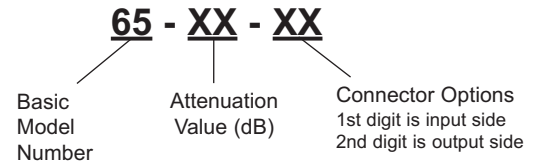

Model 79 High Power, 7/16 Connectors

dc to 6.0 GHz
150 Watts



Features

- /// Optimized for Wireless OEM & Test Applications.
- /// Low Intermodulation Design.
- /// Designed to meet environmental requirements of MIL-A-3933.

Specifications

NOMINAL IMPEDANCE: 50 Ω

FREQUENCY RANGE: dc to 5.0 GHz

MAXIMUM DEVIATION OVER FREQUENCY:

| Nominal ATTN (dB) | Deviation (dB) |
|-------------------|----------------|
| 10, 20 | ± 0.90 |
| 30 | ± 1.25 |

MAXIMUM SWR:

| Frequency (GHz) | SWR |
|-----------------|------|
| dc - 3 | 1.20 |
| 3 - 6 | 1.35 |

3rd ORDER INTERMODULATION: Reflected Levels (IM3), -100 & Through Levels (IM3), -110 dBc with two input signals @ 869 MHz and 891 MHz with average carrier power levels of +43 dBm each.

PHYSICAL DIMENSIONS:

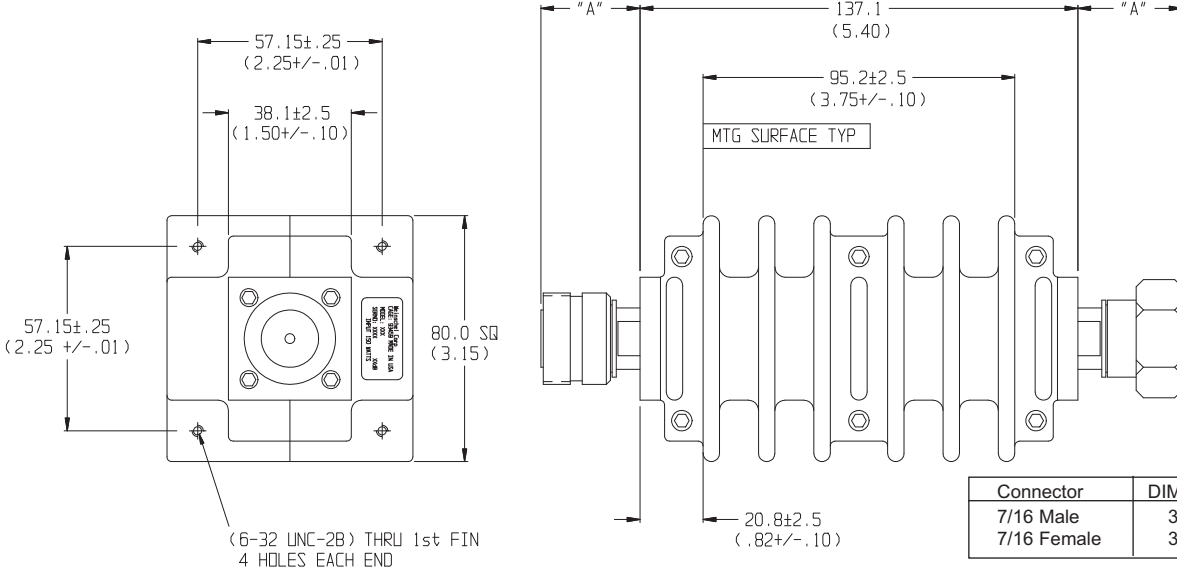

NOTE: All dimensions are given in mm (inches) and are maximum, unless otherwise specified.

POWER RATING (mounted horizontally): 150 watts average (unidirectional) to 25°C ambient temperature, derated linearly to 15 watts @ 125°C. 10 kilowatt peak (5 μsec pulse width; 0.75% duty cycle). Maximum power rating into output port is 20 watts average.

POWER COEFFICIENT: <0.0001 dB/dB/watt

TEMPERATURE COEFFICIENT: <0.0004 dB/dB/°C

TEMPERATURE RANGE: -55°C to 125°C

TEST DATA: Swept data plots of SWR from 50 MHz to 6 GHz is available at additional cost.

CONNECTORS: 7/16 connector that conforms to DIN 47223, IEC 169-4, VG 95250, CECC 22 190.

| Connector Options | Type/Description |
|-------------------|------------------|
| 1 | 7/16 Female |
| 2 | 7/16 Male |

CONSTRUCTION: Black, finned aluminum body, silver plated brass connectors.

WEIGHT: 1,248 g (2.75 lbs.) maximum

MODEL NUMBER DESCRIPTION:

Example:

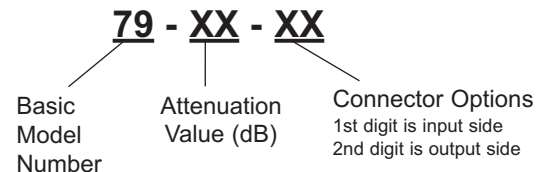

Fixed Coaxial Attenuators



Model 49 High Power, N Connectors Conduction/Convection Cooled

dc to 8.5 GHz
150 Watts

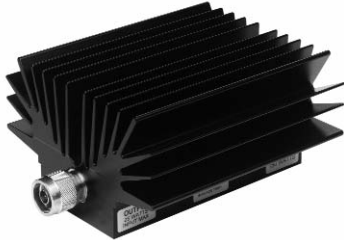

Features

- Quality connectors with special high temperature support beads.
- Designed to meet environmental requirements of MIL-DTL-3933.
- Flexible Mounting Position - The units may be mounted in horizontal (fins up) or vertical position.

Specifications

NOMINAL IMPEDANCE: 50 Ω

FREQUENCY RANGE: dc to 8.5 GHz

| MAXIMUM DEVIATION OVER FREQUENCY (dB): | | | | |
|--|------------|------------|------------|------------|
| Nominal ATTN (dB) | 49 | | 49-LIM | |
| | dc - 4 GHz | 4 -8.5 GHz | dc - 4 GHz | 4 -8.5 GHz |
| 3, 6 | ± 0.50 | ± 1.00 | --- | --- |
| 10, 20 | ± 0.40 | ± 0.75 | ± 0.70 | ± 1.25 |
| 30 | ± 0.40 | ± 0.75 | ± 0.70 | ± 1.75 |
| 40 | ± 0.50 | ± 1.00 | ± 0.70 | ± 1.75 |

| MAXIMUM SWR: | |
|-----------------|------|
| Frequency (GHz) | SWR |
| dc - 4 | 1.25 |
| 4 - 8.5 | 1.35 |

3rd ORDER INTERMODULATION (49-XX-XX-LIM ONLY): Reflected Levels (IM3), -100 & Through Levels (IM3), -110 dBc with two input signals @ 869 MHz and 891 MHz with average carrier power levels of +43 dBm each.

POWER RATING (mounted horizontally or vertically): 150 watts average (unidirectional) to 25°C ambient temperature, derated linearly to 15 watts @ 125°C. 5 kilowatt peak (5 μsec pulse width; 1.5% duty cycle). Maximum power rating into output port is 25 watts average.

POWER COEFFICIENT: <0.0001 dB/dB/watt

TEMPERATURE COEFFICIENT: <0.0004 dB/dB/°C

TEMPERATURE RANGE: -55°C to 125°C

TEST DATA: Swept data plots of attenuation and SWR from 50 MHz to 8.5 GHz.

CONNECTORS: Type N connectors per MIL-STD-348 interface dimensions - mate nondestructively with MIL-C-39012 connectors.

| Connector Options | Type/Description |
|-------------------|------------------|
| 3 | Type N, Female |
| 4 | Type N, Male |

CONSTRUCTION: Aluminum alloy body, stainless steel connectors; gold plated beryllium copper female contacts or stainless steel male contacts. (-LIM option uses different connector and contact materials)

WEIGHT: 1,450 g (3 lbs, 3 oz.) maximum

PHYSICAL DIMENSIONS:

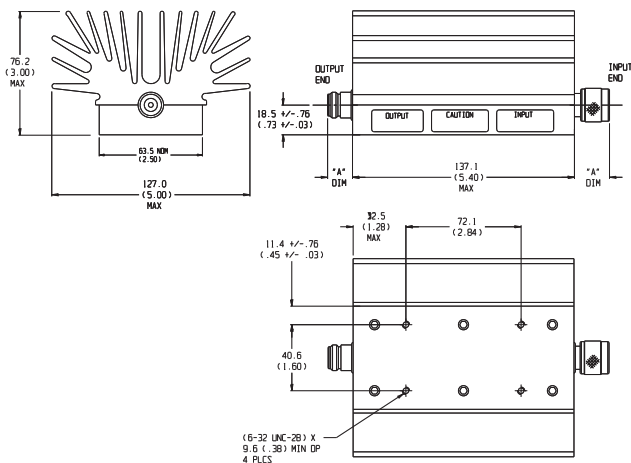

| Connector | DIM A |
|-----------|-------------|
| N Male | 22.9 (0.90) |
| N Female | 15.0 (0.59) |

NOTE: All dimensions are given in mm (inches) and are maximum, unless otherwise specified.

MODEL NUMBER DESCRIPTION:

Example:

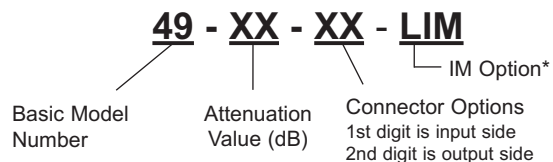

*Add -LIM for Low Intermodulation option. Option only available in 10, 20, 30, and 40 dB and is not available through Express.

Model 66 High Power, N or 3.5mm Connectors Convection Cooled

dc to 18.0 GHz
150 Watts



Features

- /// Quality injection molded connectors.
- /// Designed to meet environmental requirements of MIL-DTL-3933.
- /// Broadband performance, ideal for test applications.

Specifications

NOMINAL IMPEDANCE: 50 Ω

FREQUENCY RANGE: dc to 18.0 GHz

| MAXIMUM DEVIATION OVER FREQUENCY: | |
|-----------------------------------|----------------|
| Nominal ATTN (dB) | Deviation (dB) |
| 10 | ± 2.00 |
| 20, 30, 40 | ± 1.50 |

| MAXIMUM SWR: | | |
|-----------------|------|---------------|
| Frequency (GHz) | 10 | 20, 30, 40 dB |
| dc - 18 | 1.90 | 1.60 |

PHYSICAL DIMENSIONS:

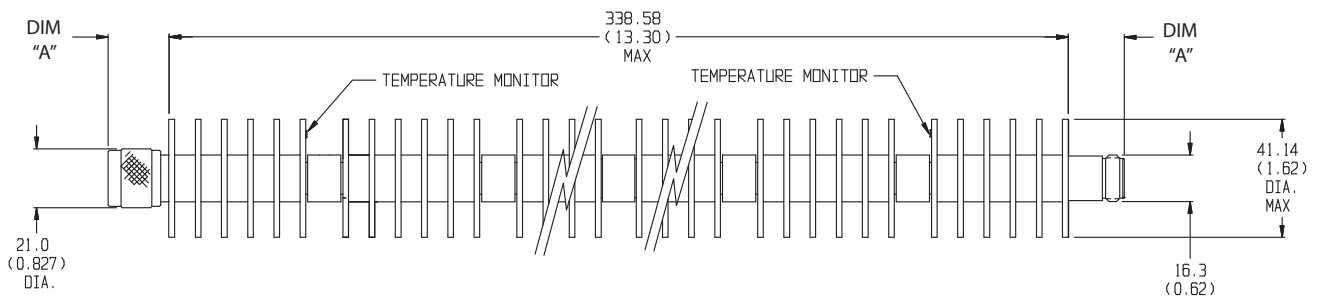

| Connector | DIM A | Connector | DIM A |
|-----------|-------------|--------------|-------------|
| N Male | 24.1 (0.95) | 3.5mm Female | 14.0 (0.55) |
| N Female | 19.0 (0.75) | 3.5mm Male | 13.2 (0.52) |

NOTE: All dimensions are given in mm (inches) and are maximum, unless otherwise specified.

POWER RATING (mounted horizontally): 150 watts average (unidirectional) @ case temperature of -55°C to +100 °C maximum. 1 kilowatt peak (5 μsec pulse width; 7.5% duty cycle). Maximum power rating into output port is 10 watts average.

POWER COEFFICIENT: <0.0001 dB/dB/watt

TEMPERATURE COEFFICIENT: <0.0004 dB/dB/°C

TEMPERATURE RANGE: -55°C to 100°C (case temp.)

TEST DATA: Swept data plots of attenuation and SWR from 50 MHz to 18 GHz.

CONNECTORS: Type N connectors per MIL-STD-348 interface dimensions - mate nondestructively with MIL-C-39012 connectors.

3.5mm Connectors - mate nondestructively with SMA per MIL-C-39012, 2.92mm and other 3.5mm connectors.

| Options | Description | Options | Description |
|---------|--------------|---------|---------------|
| 1 | 3.5mm Female | 3 | Type N Female |
| 2 | 3.5mm Male | 4 | Type N Male |

CONSTRUCTION: Aluminum alloy body, stainless steel connectors; gold plated beryllium copper contacts.

WEIGHT: 480 g (17 oz.) maximum

MODEL NUMBER DESCRIPTION:

Example:

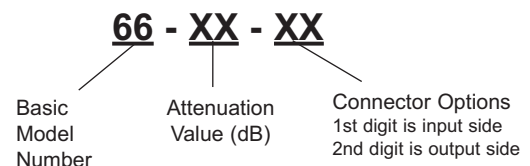

Fixed Coaxial Attenuators



Model 251 High Power, N Connectors Convection Cooled, Bi-directional



dc to 6.0 GHz
200 Watts

RoHS



Features

- Quality connectors with special high temperature support beads.
- Designed to meet environmental requirements of MIL-DTL-3933.

Specifications

NOMINAL IMPEDANCE: 50 Ω
FREQUENCY RANGE: dc to 6.0 GHz

MAXIMUM DEVIATION OVER FREQUENCY:

| Nominal ATTN (dB) | Deviation (dB) |
|-------------------|----------------|
| 10, 20, 30, 40 | ± 2.00 |

MAXIMUM SWR:

| Frequency (GHz) | SWR |
|-----------------|------|
| dc - 2 | 1.10 |
| 2 - 6 | 1.20 |

POWER RATING: 200 watts **average (Bi-directional)** to 25°C ambient temperature, derated linearly to 20 watts @ 125°C ambient. 10 kilowatt **peak** (5 μsec pulse width; 1% duty cycle).

POWER COEFFICIENT: <0.0001 dB/dB/watt

TEMPERATURE COEFFICIENT: <0.0004 dB/dB/°C

TEMPERATURE RANGE: -55°C to 125°C

TEST DATA: Swept data plots of attenuation and SWR from 50 MHz to 6 GHz.

CONNECTORS: Type N connectors per MIL-STD-348 interface dimensions - mate nondestructively with MIL-C-39012 connectors.

| Connector Options | Type/Description |
|-------------------|------------------|
| 3 | Type N, Female |
| 4 | Type N, Male |

CONSTRUCTION: Black Finned Aluminum alloy body, stainless steel connectors; gold plated beryllium copper contacts.

WEIGHT: 1,530 g (3 lbs, 6 oz) maximum

MODEL NUMBER DESCRIPTION:

Example:

251 - XX - XX

Basic Model Number

Attenuation Value (dB)

Connector Options
1st digit is input side
2nd digit is output side

PHYSICAL DIMENSIONS:

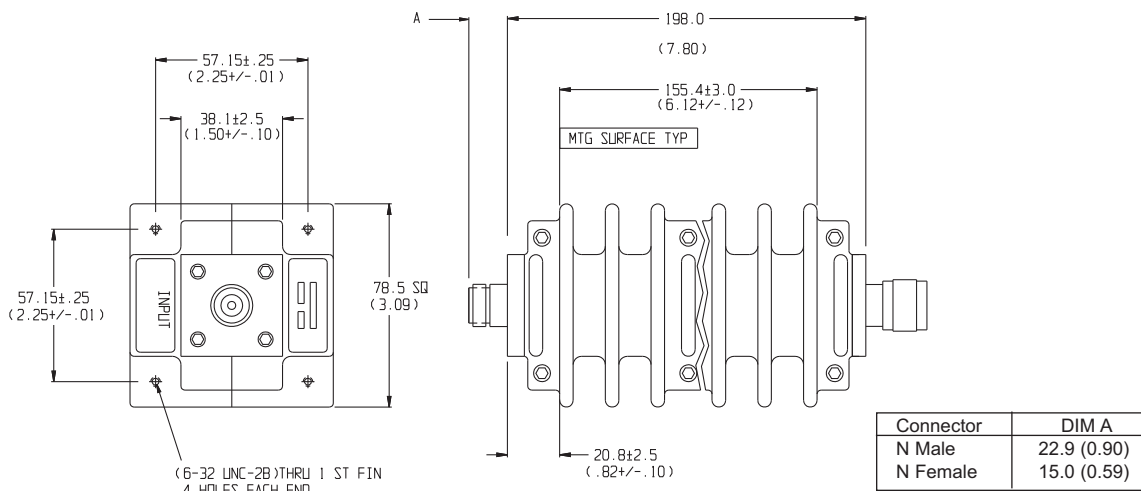

NOTE: All dimensions are given in mm (inches) and are maximum, unless otherwise specified.

Model 45

Model 58

High Power, N or SMK Connectors

Convection Cooled

dc to 1.5 GHz

dc to 6.0 GHz

250 Watts

RoHS



Features

- Quality connectors with special high temperature support beads.
- Designed to meet environmental requirements of MIL-DTL-3933.

Specifications

NOMINAL IMPEDANCE: 50 Ω

FREQUENCY RANGE: Model 45: dc to 1.5 GHz
Model 58: dc to 6.0 GHz

MAXIMUM DEVIATION OVER FREQUENCY:

| Nominal ATTN (dB) | Deviation (dB) | | |
|-------------------|----------------|--------|--------|
| | 45 | 58 | 58 LIM |
| 3, 6 | ± 0.50 | ± 1.50 | --- |
| 10, 20 | ± 0.50 | ± 1.50 | ± 2.00 |
| 30, 40 | ± 0.50 | ± 1.75 | ± 3.00 |

MAXIMUM SWR:

| Frequency (GHz) | 45/58 | | 58 LIM | |
|-----------------|-------|--------------|--------|--------|
| | Input | Output | Input | Output |
| dc - 2 (1.5*) | 1.10 | 1.20 (1.10*) | 1.20 | 1.25 |
| 2 - 6 | 1.15 | 1.25 | 1.20 | 1.25 |

* Model 45 only!

3rd ORDER INTERMODULATION (58-XX-XX-LIM ONLY):

Reflected Levels (IM3), -100 & Through Levels (IM3), -110 dBc with two input signals @ 869 MHz and 891 MHz with average carrier power levels of +43 dBm each.

PHYSICAL DIMENSIONS:

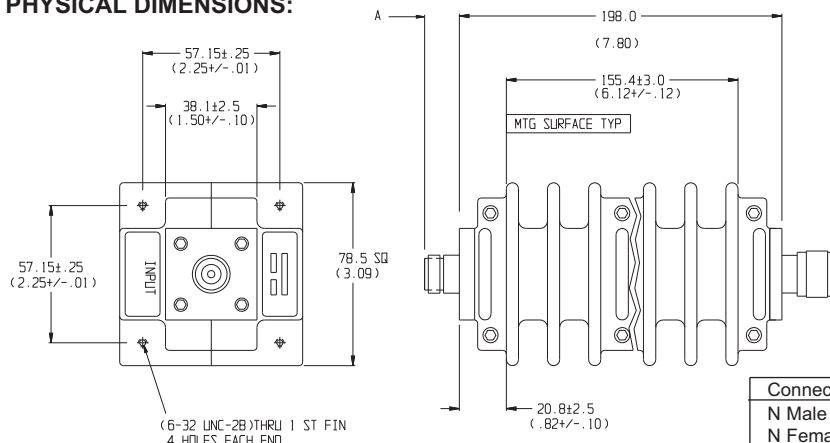

NOTE: All dimensions are given in mm (inches) and are maximum, unless otherwise specified.

| Connector | DIM A | Connector | DIM A |
|-----------|-------------|---------------|-------------|
| N Male | 22.9 (0.90) | 2.92mm Male | 14.0 (0.55) |
| N Female | 15.0 (0.59) | 2.92mm Female | 12.7 (0.50) |

POWER RATING (mounted horizontally with fins vertical): 250 watts average (unidirectional) to 55°C ambient temperature, derated linearly to 25 watts @ 125°C. 10 kilowatt peak (5 μsec pulse width; 1.25% duty cycle). Maximum power rating into output port is 50 watts average.

POWER COEFFICIENT: <0.0001 dB/dB/watt

TEMPERATURE COEFFICIENT: <0.0004 dB/dB/°C

TEMPERATURE RANGE: -55°C to 125°C

TEST DATA: Swept data plots of attenuation and SWR from 50 MHz to 1.5 / 6 GHz.

CONNECTORS: Type N connectors per MIL-STD-348 interface dimensions - mate nondestructively with MIL-C-39012 connectors. SMK (2.92mm) connectors - mate nondestructively with SMA per MIL-C-39012, 3.5mm, SMK, and other 2.92mm connectors.

| Options | Description | Options | Description |
|---------|-------------|---------|---------------|
| 1 | SMK Female | 3 | Type N Female |
| 2 | SMK Male | 4 | Type N Male |

CONSTRUCTION: Aluminum alloy body, stainless steel connectors; gold plated beryllium copper contacts.

WEIGHT: 1,530 g (3 lbs, 6 oz.) maximum

MODEL NUMBER DESCRIPTION:

Example:

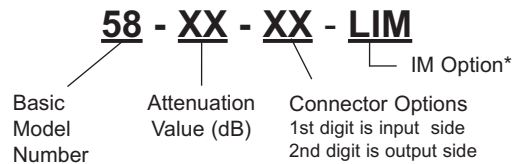

* Add -LIM for Low Intermodulation option. Option only available with Model 58 in 10, 20, 30, 40 dB and is not available through Express.

Model 67 High Power Fixed Coaxial Attenuator *Forced Cooled*

dc to 12.7 GHz
350 Watts



Features

- /// Precision Injection Molded Connectors.
- /// Designed to meet environmental requirements of MIL-DTL-3933.
- /// Broadband performance, ideal for test applications.

Specifications

NOMINAL IMPEDANCE: 50 Ω

FREQUENCY RANGE: dc to 12.7 GHz

MAXIMUM DEVIATION OVER FREQUENCY:

| Nominal ATTN (dB) | Deviation (dB) | |
|-------------------|----------------|-------------|
| | dc-8 GHz | 8 -12.7 GHz |
| 10 | ± 2.00 | +6.00/-0.00 |
| 20, 30 | ± 2.50 | +6.00/-0.00 |

MAXIMUM SWR:

| Frequency (GHz) | SWR |
|-----------------|------|
| dc - 8 | 1.30 |
| 8 - 12.7 | 1.60 |

POWER RATING (mounted horizontally): 350 watts average (unidirectional) @ 25°C ambient temperature. Case temperature must be held to **100°C maximum**. 5 kilowatt **peak** (5 μsec pulse width; 3.5% duty cycle). Maximum power rating into output port is 10 watts average.

TEMPERATURE COEFFICIENT: <0.0004 dB/dB/°C

TEMPERATURE RANGE: -55°C to 100°C (case temp.)

TEST DATA: Swept data plots of attenuation and SWR from 50 MHz to 12.7 GHz.

CONNECTORS: Type N connectors per MIL-STD-348 interface dimensions - mate nondestructively with MIL-C-39012 connectors.

| Connector Options | Type/Description |
|-------------------|------------------|
| 3 | Type N, Female |
| 4 | Type N, Male |

CONSTRUCTION: Aluminum alloy body, stainless steel connectors; gold plated beryllium copper contacts.

WEIGHT: 1200 g (43 oz.) maximum

MODEL NUMBER DESCRIPTION:

Example:

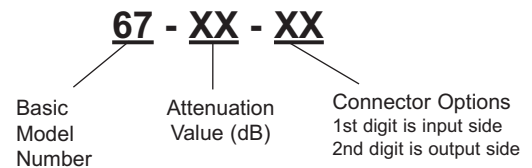

PHYSICAL DIMENSIONS:

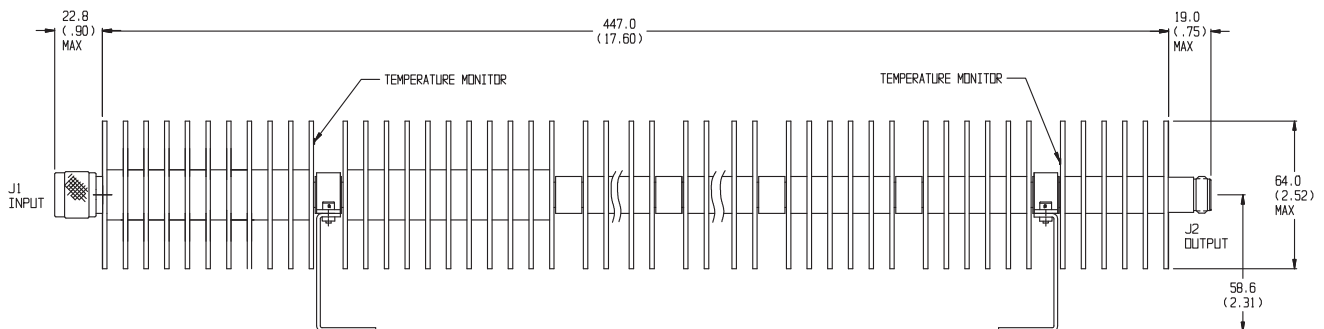

NOTE: All dimensions are given in mm (inches) and are maximum, unless otherwise specified.

Model 53 High Power, N Connectors Conduction/Convection Cooled

dc to 2.5 GHz
500 Watts



Features

- /// Quality connectors with special high temperature support beads.
- /// Designed to meet environmental requirements of MIL-DTL-3933.
- /// Flexible Mounting Position - The units may be mounted in horizontal (fins up) or vertical position.
- /// Low Intermodulation Distortion Option.

Specifications

NOMINAL IMPEDANCE: 50 Ω

FREQUENCY RANGE: dc to 2.5 GHz

MAXIMUM DEVIATION OVER FREQUENCY:

| Nominal ATTN (dB) | Deviation (dB) | |
|-------------------|----------------|--------|
| | 53 | 53 LIM |
| 3, 6 | ± 1.00 | --- |
| 10, 20, 30, 40 | ± 1.00 | ± 1.20 |

MAXIMUM SWR:

| Frequency (GHz) | 53 | 53 LIM |
|-----------------|------|--------|
| dc - 2.5 | 1.10 | 1.15 |

3rd ORDER INTERMODULATION (53-XX-XX-LIM ONLY): Reflected Levels (IM3), -100 & Through Levels (IM3), -110 dBc with two input signals @ 869 MHz and 891 MHz with average carrier power levels of +43 dBm each.

POWER RATING (mounted horizontally with fins vertical): 500 watts average (unidirectional) to 25°C ambient temperature, derated linearly to 50 watts @ 125°C. 10 kilowatt peak (5 μsec pulse width; 2.5% duty cycle). Maximum power rating into output port is 50 watts average.

TEMPERATURE COEFFICIENT: <0.0004 dB/dB/°C

TEMPERATURE RANGE: -55°C to 125°C

TEST DATA: Swept data plots of attenuation and SWR from 50 MHz to 2.5 GHz.

CONNECTORS: Type N connectors per MIL-STD-348 interface dimensions - mate nondestructively with MIL-C-39012 connectors.

| Connector Options | Type/Description |
|-------------------|------------------|
| 3 | Type N, Female |
| 4 | Type N, Male |

CONSTRUCTION: Aluminum alloy body, gold plated beryllium copper contacts.

WEIGHT: 3,640 g (8 lbs.) maximum

PHYSICAL DIMENSIONS:

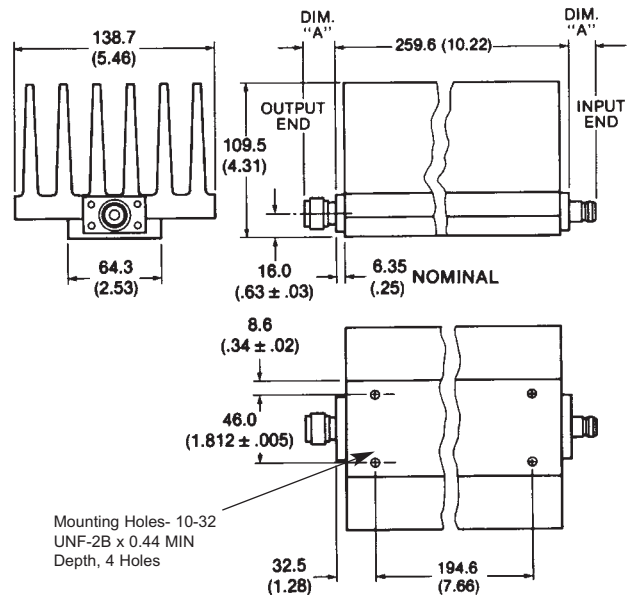

| Connector | DIM A |
|-----------|-------------|
| N Male | 22.9 (0.90) |
| N Female | 15.0 (0.59) |

NOTE: All dimensions are given in mm (inches) and are maximum, unless otherwise specified.

MODEL NUMBER DESCRIPTION:

Example:

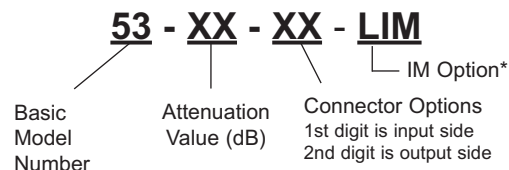

*Add -LIM for Low Intermodulation option. Option only available in 10, 20, 30 and 40 dB and is not available through Express.

Fixed Coaxial Attenuators



Model 81 High Power, N Connectors Conduction/Convection Cooled

dc to 10.0 GHz
500 Watts



CONNECTOR: Type N connectors - mate nondestructively with MIL-C-39012 connectors.

| Options | Type/Description |
|---------|------------------|
| 3 | Type N, Female |
| 4 | Type N, Male |

CONSTRUCTION: Black, finned aluminum body, stainless steel or connectors with gold plated beryllium copper contacts.

WEIGHT: 10 dB: 5.3 kg (11 lbs, 11 oz) maximum
20, 30, 40 dB: 6.24 Kg (13 lbs, 12 oz) maximum

PHYSICAL DIMENSIONS:

Features

- Quality connectors with special high temperature support beads.
- Designed to meet environmental requirements of MIL-DTL-3933.

Specifications

NOMINAL IMPEDANCE: 50 Ω
FREQUENCY RANGE: dc to 10.0 GHz

MAXIMUM DEVIATION OVER FREQUENCY (dB):

| NOM ATTN (dB) | Deviation | |
|----------------|--------------|----------------|
| | dc - 7.0 GHz | 7.0 - 10.0 GHz |
| 10, 20, 30, 40 | ±3.0 | +5 / -0 dB |

MAXIMUM SWR:

| Frequency (GHz) | SWR |
|-----------------|------|
| dc - 9.0 | 1.50 |
| 9.0 - 10.0 | 1.90 |

POWER RATING: 500 watts **average (unidirectional)** to 25°C ambient temperature, derated linearly to 50 watts @ 125°C. 5 kilowatt **peak** (5 μsec pulse width; 5% duty cycle). Maximum power into output is 20 Watts **average**.

TEMPERATURE COEFFICIENT: <0.0004 dB/dB/°C

TEMPERATURE RANGE: -55°C to +125°C

TEST DATA: Swept data plots of attenuation and SWR from 50 MHz to 10 GHz.

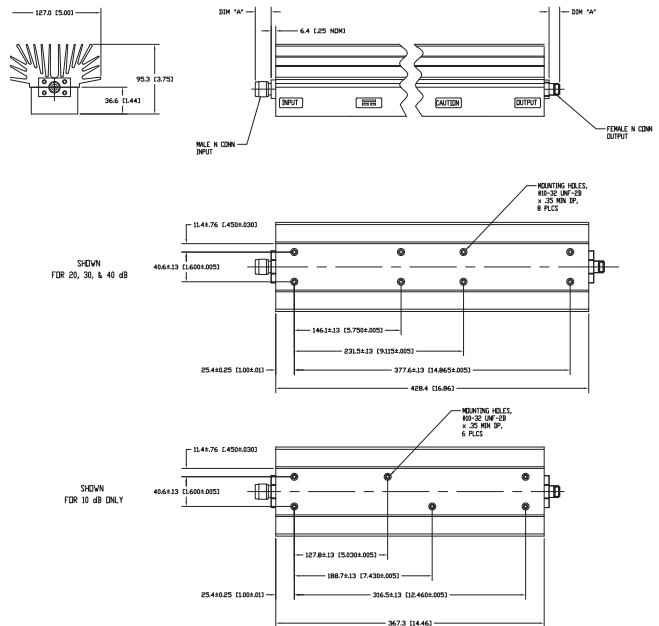

| Connector Type | DIM A |
|----------------|-------------|
| N female | 15.0 (0.59) |
| N male | 22.9 (0.90) |

NOTE: All dimensions are given in mm (inches) and are maximum, unless otherwise specified.

MODEL NUMBER DESCRIPTION:

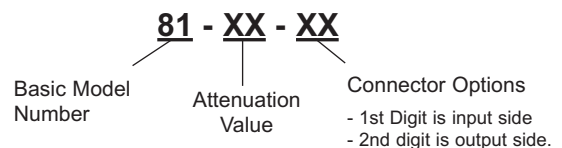

Model 82 High Power, N Connectors

dc to 3.0 GHz
1,000 Watts



Features

- Quality connectors with special high temperature support beads.
- Designed to meet environmental requirements of MIL-DTL-3933.

Specifications

NOMINAL IMPEDANCE: 50 Ω

FREQUENCY RANGE: dc to 3.0 GHz

| MAXIMUM DEVIATION OVER FREQUENCY (dB): | | |
|--|--------------|---------------|
| NOM ATTN (dB) | Deviation | |
| | dc - 1.5 GHz | 1.5 - 3.0 GHz |
| 10, 20, 30, 40 | ±1.0 | +1.5, -1.0 dB |

| MAXIMUM SWR: | |
|-----------------|------|
| Frequency (GHz) | SWR |
| dc - 1.5 | 1.15 |
| 1.5 - 3.0 | 1.25 |

PHYSICAL DIMENSIONS:

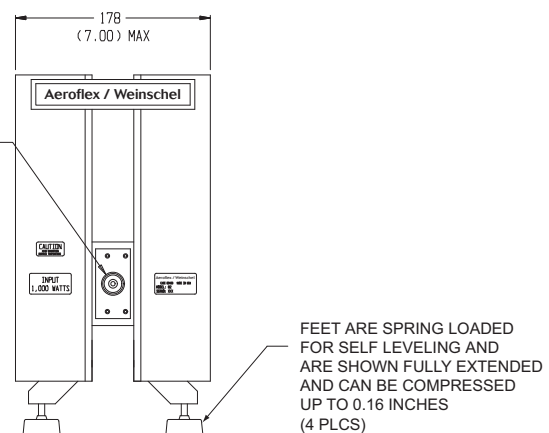
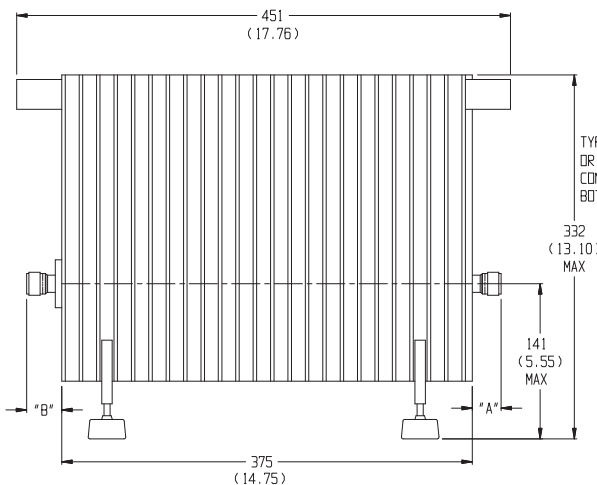

POWER RATING: 1,000 watts **average** (unidirectional) to 25°C ambient temperature, derated linearly to 100 watts @ 125°C. 10 kilowatt **peak** (5 μsec pulse width; 5% duty cycle). Maximum power into output is 75 Watts **average**.

TEMPERATURE COEFFICIENT: <0.0004 dB/dB/°C

TEMPERATURE RANGE: -55°C to +125°C with power derating applied.

TEST DATA: Swept data plots of attenuation and SWR from 50 MHz to 3.0 GHz is available at additional cost.

CONNECTOR: Type N connectors - mate nondestructively with MIL-C-39012 connectors .

| Options | Type/Description |
|---------|------------------|
| 3 | Type N, Female |
| 4 | Type N, Male |

CONSTRUCTION: Black, finned aluminum body, stainless steel with gold plated beryllium copper contacts.

WEIGHT: Net 13 kg (28.7 lbs) maximum

MODEL NUMBER DESCRIPTION:

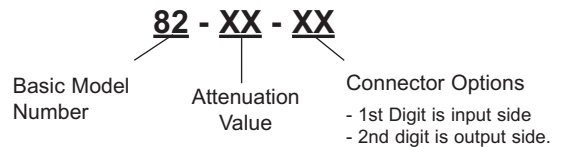

NOTE:

- All dimensions are given in mm (inches) and are maximum, unless otherwise specified.
- Unit available with RoHS compliant materials, specify when ordering.

| Connector Type | DIM A | DIM B |
|----------------|-------------|-------------|
| N female | 15.0 (0.59) | 21.4 (0.84) |
| N male | 22.9 (0.90) | 29.3 (1.15) |

Fixed Coaxial Attenuators



Model 275 Medium Power, SMK Connectors Conduction Cooled, Bi-directional Design

NEW dc to 40.0 GHz
5 Watts

RoHS



Features

- /// Compact Construction - Lowest size/power ratio.
- /// Precision injection molded connectors.
- /// Designed to meet environmental requirements of MIL-DTL-3933.
- /// Flat Response & Low SWR.

Specifications

NOMINAL IMPEDANCE: 50 Ω
FREQUENCY RANGE: dc to 40.0 GHz

MAXIMUM DEVIATION OVER FREQUENCY:

| Nominal ATTN (dB) | Deviation (dB) | |
|-------------------|----------------|-------------|
| | dc-26.5 GHz | 26.5-40 GHz |
| 3 | ± 0.50 | ± 1.00 |
| 6, 10, 20, 30 | ± 0.80 | ± 1.50 |

MAXIMUM SWR:

| Frequency (GHz) | SWR |
|-----------------|------|
| dc - 26.5 | 1.25 |
| 26.5 - 40 | 1.45 |

POWER RATING: 5 watts **average (bi-directional)** with case temperature limited to 100 °C with appropriate conductive heat sink. 200 watts **peak** (5 μsec pulse width; 1.25% duty cycle).

POWER COEFFICIENT: <0.002 dB/dB/watt

TEMPERATURE COEFFICIENT: <0.0004 dB/dB/°C

TEMPERATURE RANGE: -55 °C to 100 °C (case)

TEST DATA: Swept data plots of attenuation and SWR from 50 MHz to 40 GHz.

CONNECTORS: SMK (2.92mm) Male/Female connectors - mate nondestructively with SMA per MIL-C-39012, 3.5mm and other 2.92mm connectors.

| Connector Options | Type/Description |
|-------------------|------------------|
| 1 | SMK, Female |
| 2 | SMK, Male |

CONSTRUCTION: Aluminum body, gold plated beryllium copper contacts.

WEIGHT: 17 g (0.6 oz.) maximum

PHYSICAL DIMENSIONS:

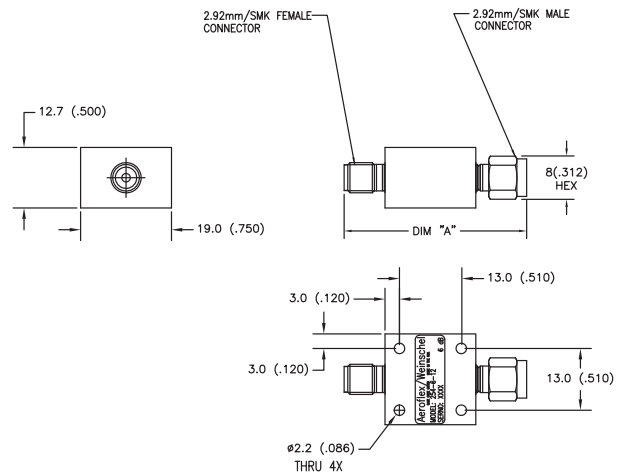

| Dash No. | Connector Type | DIM A |
|----------|----------------------|-------------|
| 11 | 2.92mm Female/Female | 39.6 (1.56) |
| 12 | 2.92mm Male/Female | 44.2 (1.74) |
| 22 | 2.92mm Male/Male | 48.8 (1.92) |

NOTE: All dimensions are given in mm (inches) and are nominal, unless otherwise specified.

MODEL NUMBER DESCRIPTION:

Example:

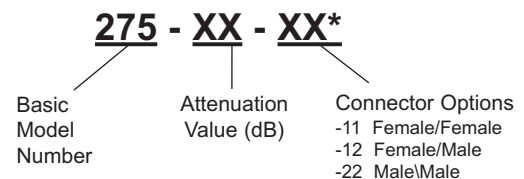

*Unit is bi-directional and full power may be applied to either connector.

Model 72 Medium Power, N or SMK Connectors Conduction Cooled, Bi-Directional Design!

dc to 4.0 GHz
50 Watts



Features

- /// **Compact Construction** - Lowest size/power ratio.
- /// **Precision Connectors with high temperature support beads.**
- /// **Designed to meet environmental requirements of MIL-DTL-3933.**
- /// **Wireless Applications** - Optimized for use in the communications bands.

Specifications

NOMINAL IMPEDANCE: 50 Ω

FREQUENCY RANGE: dc to 4.0 GHz

MAXIMUM DEVIATION OVER FREQUENCY:

| Nominal ATTN (dB) | Deviation (dB) |
|----------------------|----------------|
| 3, 6, 10, 20, 30, 40 | ± 0.70 |

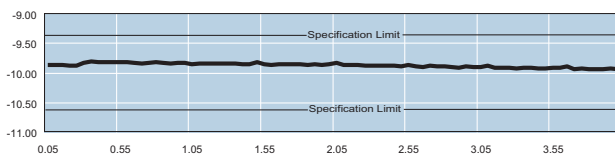

Typical Attenuation Accuracy of a 72-10-34

MAXIMUM SWR:

| Frequency (GHz) | SWR |
|-----------------|------|
| dc - 4 | 1.20 |

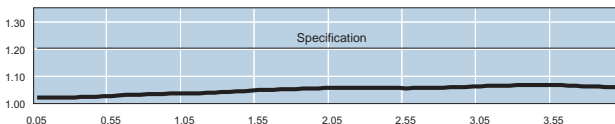

Typical SWR of a 72-10-34

POWER RATING 50 watts **average (bi-directional)**, 5 kilowatts **peak** (5 μsec pulse width; 0.5 % duty cycle) with case temperature held within **100°C maximum** with appropriate conductive heat sink.

POWER COEFFICIENT: <0.0003 dB/dB/watt

TEMPERATURE COEFFICIENT: <0.0004 dB/dB/°C

TEMPERATURE RANGE: -55°C to 100°C (case)

TEST DATA: Swept data plots of attenuation and SWR from 50 MHz to 4 GHz is available at additional cost.

CONNECTORS: Type N connectors per MIL-STD-348 interface dimensions - mate nondestructively with MIL-C-39012 connectors. SMK (2.92mm) connectors - mate nondestructively with SMA per MIL-C-39012, 3.5mm, SMK, and other 2.92mm connectors.

| Options | Description | Options | Description |
|---------|-------------|---------|---------------|
| 1 | SMK Female | 3 | Type N Female |
| 2 | SMK Male | 4 | Type N Male |

CONSTRUCTION: Aluminum body, stainless steel connectors; gold plated beryllium copper contacts.

WEIGHT: 170 g (6 oz.) maximum

PHYSICAL DIMENSIONS:

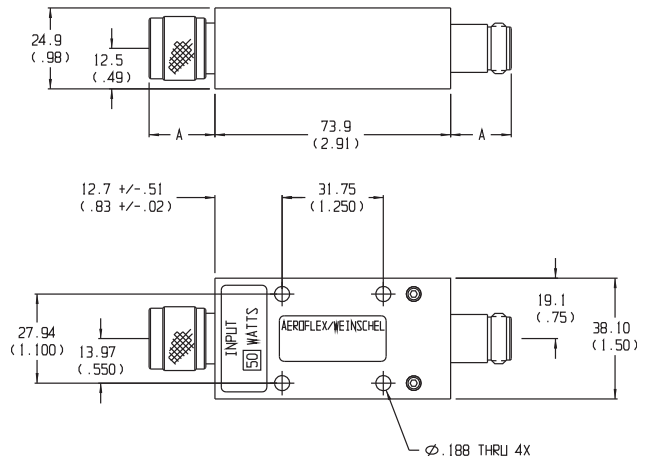

| Connector | DIM A | Connector | DIM A |
|-----------|-------------|---------------|-------------|
| N Male | 22.9 (0.90) | 2.92mm Male | 14.0 (0.55) |
| N Female | 15.0 (0.59) | 2.92mm Female | 12.7 (0.50) |

NOTE: All dimensions are given in mm (inches) and are maximum, unless otherwise specified.

MODEL NUMBER DESCRIPTION:

Example:

72 - XX - XX*

Basic Model Number

Attenuation Value (dB)

Connector Options
1st digit is J1 side
2nd digit is J2 side

*Unit is bi-directional & full power may be applied to either J1 or J2.

Fixed Coaxial Attenuators



Model 86 Medium Power, 3.5mm Connectors Conduction Cooled, Bi-directional Design

dc to 22.0 GHz
50 Watts



CONSTRUCTION: Aluminum body, stainless steel connectors; gold plated beryllium copper contacts.

WEIGHT: 60 g (2.1 oz.) maximum

PHYSICAL DIMENSIONS:

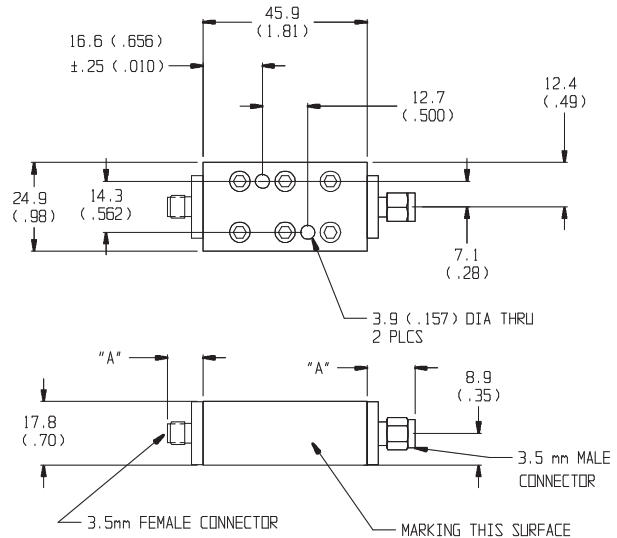

Features

- /// **Compact Construction** - Lowest size/power ratio.
- /// **Precision Injection Molded Connectors.**
- /// **Designed to meet environmental requirements of MIL-DTL-3933.**
- /// **Ideal for Airborne or Space Applications.**

Specifications

NOMINAL IMPEDANCE: 50 Ω
FREQUENCY RANGE: dc to 22.0 GHz

MAXIMUM DEVIATION OVER FREQUENCY:

| Nominal ATTN (dB) | Deviation (dB) |
|-------------------|----------------|
| 3, 6, 10, 20, 30 | ± 0.80 |

MAXIMUM SWR: 1.30

POWER RATING 50 watts **average (bi-directional)**, 1 kilowatts **peak** (5 μsec pulse width; 2.5 % duty cycle) with case temperature held within **90°C maximum** with appropriate conductive heat sink.

POWER COEFFICIENT: <0.0003 dB/dB/watt

TEMPERATURE COEFFICIENT: <0.0004 dB/dB/°C

TEMPERATURE RANGE: -55°C to 90°C (case)

TEST DATA: Swept data plots of attenuation and SWR from 50 MHz to 22 GHz.

CONNECTORS: 3.5mm connectors - mate nondestructively with SMA per MIL-C-39012, 2.92mm and other 3.5mm connectors.

| Options | Description |
|---------|--------------|
| 1 | 3.5mm Female |
| 2 | 3.5mm Male |

| Connector | DIM A |
|--------------|----------------------|
| 3.5mm Male | 13.4±0.5 (0.53±0.02) |
| 3.5mm Female | 9.9±0.5 (0.32±0.02) |

NOTE: All dimensions are given in mm (inches) and are nominal, unless otherwise specified.

MODEL NUMBER DESCRIPTION:

Example:

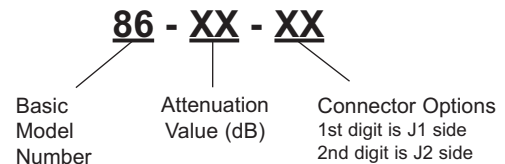

*Unit is bi-directional and full power may be applied to either J1 or J2.

Model 59 High Power, N or SMK Connectors Conduction Cooled

dc to 2.5 GHz
100 Watts

RoHS



Features

- /// Precision Connectors with high temperature support beads.
- /// Designed to meet environmental requirements of MIL-DTL-3933.
- /// 10 Kilowatts peak, Conductive Cooled
- /// Wireless Applications - Optimized for use in the communications bands.

Specifications

NOMINAL IMPEDANCE: 50 Ω

FREQUENCY RANGE: dc to 2.5 GHz

MAXIMUM DEVIATION OVER FREQUENCY:

| Nominal ATTN (dB) | Deviation (dB) | |
|----------------------|----------------|-----------|
| | dc-1 GHz | 1-2.5 GHz |
| 3, 6, 10, 20, 30, 40 | ± 0.70 | ± 1.00 |

MAXIMUM SWR:

| Frequency (GHz) | SWR |
|-----------------|------|
| dc - 2.5 | 1.15 |

POWER RATING 100 watts **average (unidirectional)**, 10 kilowatts **peak** (5 μsec pulse width; 0.5 % duty cycle) with case temperature held within **100 °C maximum** with appropriate conductive heat sink. Note: 3 dB model can handle 200 Watts **average (unidirectional)**. Maximum power rating into output port is 10 % of the average power rating.

POWER COEFFICIENT: <0.00015 dB/dB/watt

TEMPERATURE COEFFICIENT: <0.0004 dB/dB/°C

TEMPERATURE RANGE: -55°C to 100°C (case temp)

TEST DATA: Swept data plots of attenuation and SWR from 50 MHz to 2.5 GHz.

CONNECTORS: Type N connectors per MIL-STD-348 interface dimensions - mate nondestructively with MIL-C-39012 connectors. SMK (2.92mm) connectors mate with SMA, 3.5mm and other 2.92mm connectors.

| Options | Description | Options | Description |
|---------|-------------|---------|---------------|
| 1 | SMK Female | 3 | Type N Female |
| 2 | SMK Male | 4 | Type N Male |

CONSTRUCTION: Aluminum alloy body, stainless steel connectors; gold plated beryllium copper contacts.

WEIGHT: 300 g (10.6 oz.) maximum

PHYSICAL DIMENSIONS:

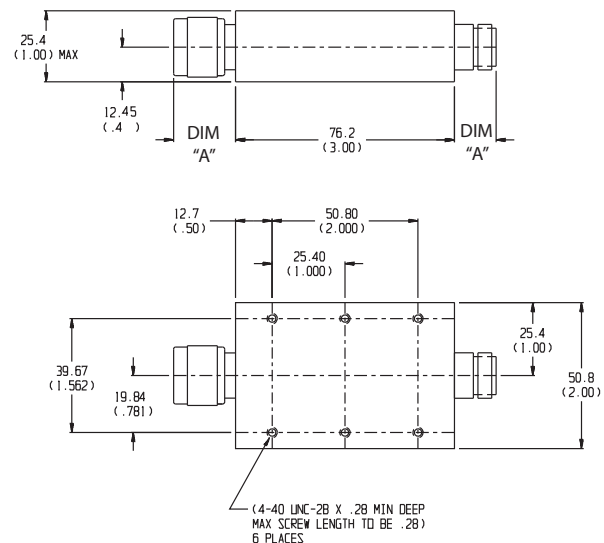

| Connector | DIM A | Connector | DIM A |
|-----------|-------------|---------------|-------------|
| N Male | 22.9 (0.90) | 2.92mm Male | 14.0 (0.55) |
| N Female | 15.0 (0.59) | 2.92mm Female | 12.7 (0.50) |

NOTE: All dimensions are given in mm (inches) and tolerances are .X±0.5 (0.02) & .XX±0.25 (0.01), unless otherwise specified.

MODEL NUMBER DESCRIPTION:

Example:

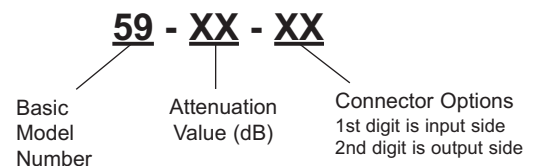

Fixed Coaxial Attenuators



Model 268 High Power, N or SMK Connectors Conduction Cooled



dc to 6.0 GHz
100 Watts
 RoHS



Features

- /// Precision Connectors with high temperature support beads.
- /// Designed to meet environmental requirements of MIL-DTL-3933.
- /// 10 Kilowatts peak, Conduction Cooled
- /// Wireless Applications - Optimized for use in the communications bands.

Specifications

NOMINAL IMPEDANCE: 50 Ω
FREQUENCY RANGE: dc to 6.0 GHz

MAXIMUM DEVIATION OVER FREQUENCY:

| Nominal ATTN (dB) | Deviation (dB) |
|-------------------|----------------|
| 10, 20, 30, 40 | ± 1.00 |

MAXIMUM SWR:

| Frequency (GHz) | SWR |
|-----------------|------|
| dc - 2.5 | 1.10 |
| 2.5 - 6 | 1.15 |

3rd ORDER INTERMODULATION (268-XX-XX-LIM ONLY): Reflected Levels (IM3), -100 & Through Levels (IM3), -110 dBc with two input signals @ 869 MHz and 891 MHz with average carrier power levels of +43 dBm each.

POWER RATING (mounted horizontally): 100 watts average (unidirectional), 10 kilowatt peak (5 μsec pulse width; 0.5% duty cycle) with case temperature held within **100 °C maximum** with appropriate conductive heat sink.

POWER COEFFICIENT: <0.00015 dB/dB/watt

TEMPERATURE COEFFICIENT: <0.0004 dB/dB/°C

TEMPERATURE RANGE: -55 to 100°C (case temperature)

TEST DATA: Swept data plots of attenuation and SWR from 50 MHz to 6 GHz.

CONNECTORS: Type N connectors per MIL-STD-348 interface dimensions - mate nondestructively with MIL-C-39012 connectors. SMK (2.92mm) connectors mate with SMA, 3.5mm and other 2.92mm connectors.

| Options | Description | Options | Description |
|---------|-------------|---------|---------------|
| 1 | SMK Female | 3 | Type N Female |
| 2 | SMK Male | 4 | Type N Male |

CONSTRUCTION: Aluminum alloy body, stainless steel connectors; gold plated beryllium copper contacts.

WEIGHT: 300 g (10.6 oz.) maximum

PHYSICAL DIMENSIONS:

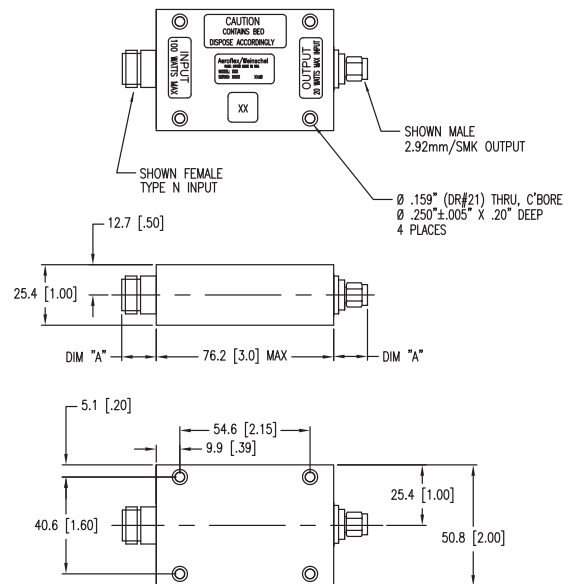

| Connector | DIM A | Connector | DIM A |
|-----------|-------------|---------------|-------------|
| N Male | 22.9 (0.90) | 2.92mm Male | 14.0 (0.55) |
| N Female | 15.0 (0.59) | 2.92mm Female | 12.7 (0.50) |

NOTE: All dimensions are given in mm (inches) and are nominal, unless otherwise specified.

MODEL NUMBER DESCRIPTION:

Example:

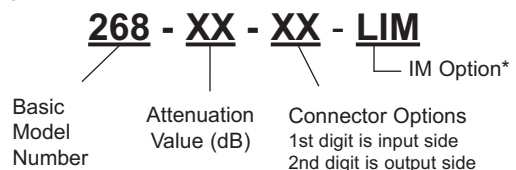

* Add -LIM for Low Intermodulation option.

Model 257 High Power, N or SMK Connectors Conduction Cooled



dc to 6.0 GHz
250 Watts



Features

- /// Precision Connectors with high temperature support beads.
- /// Designed to meet environmental requirements of MIL-DTL-3933.
- /// 10 Kilowatts peak, Conduction Cooled
- /// Wireless Applications - Optimized for use in the communications bands.

Specifications

NOMINAL IMPEDANCE: 50 Ω

FREQUENCY RANGE: dc to 6.0 GHz

| MAXIMUM DEVIATION OVER FREQUENCY: | |
|-----------------------------------|----------------|
| Nominal ATTN (dB) | Deviation (dB) |
| 10, 20, 30, 40 | ± 1.00 |

| MAXIMUM SWR: | |
|-----------------|------|
| Frequency (GHz) | SWR |
| dc - 2.5 | 1.10 |
| 2.5 - 6 | 1.15 |

3rd ORDER INTERMODULATION (257-XX-XX-LIM ONLY): Reflected Levels (IM3), -100 & Through Levels (IM3), -110 dBc with two input signals @ 869 MHz and 891 MHz with average carrier power levels of +43 dBm each.

POWER RATING: 250 watts **average (unidirectional)**, 10 kilowatt **peak** (5 μsec pulse width; 1.25% duty cycle) with case temperature held within **100 °C maximum** with appropriate conductive heat sink. Maximum power rating into output port is 40 watts average.

POWER COEFFICIENT: <0.0001 dB/dB/°C

TEMPERATURE COEFFICIENT: <0.0004 dB/dB/°C

TEMPERATURE RANGE: -55 to 100°C (case temperature)

TEST DATA: Swept data plots of attenuation and SWR from 50 MHz to 6 GHz.

CONNECTORS: Type N connectors per MIL-STD-348 interface dimensions - mate nondestructively with MIL-C-39012 connectors. SMK (2.92mm) connectors mate with SMA, 3.5mm and other 2.92mm connectors.

| Options | Description | Options | Description |
|---------|-------------|---------|---------------|
| 1 | SMK Female | 3 | Type N Female |
| 2 | SMK Male | 4 | Type N Male |

CONSTRUCTION: Aluminum alloy body, stainless steel connectors; gold plated beryllium copper contacts.

WEIGHT: 500 g (17.6 oz.) maximum

PHYSICAL DIMENSIONS:

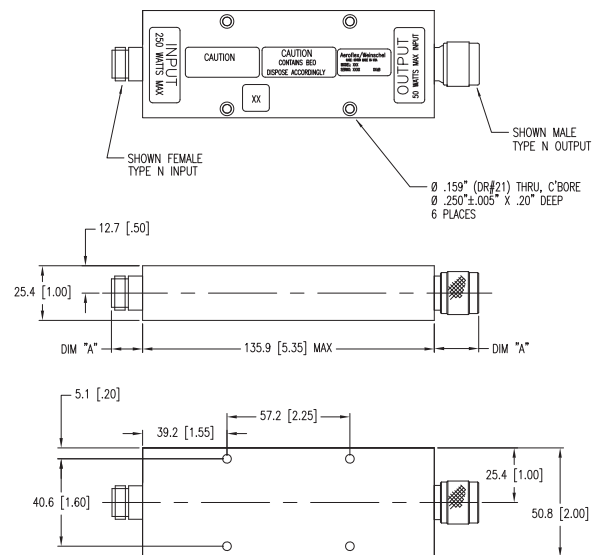

| Connector | DIM A | Connector | DIM A |
|-----------|-------------|---------------|-------------|
| N Male | 22.9 (0.90) | 2.92mm Male | 14.0 (0.55) |
| N Female | 15.0 (0.59) | 2.92mm Female | 12.7 (0.50) |

NOTE: All dimensions are given in mm (inches) and are maximum, unless otherwise specified.

MODEL NUMBER DESCRIPTION:

Example:

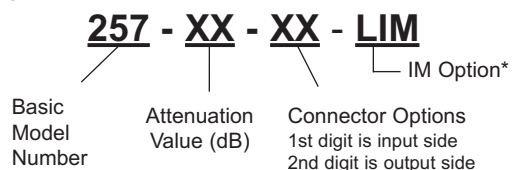

* Add -LIM for Low Intermodulation option.

Fixed Coaxial Attenuators



Model 258 High Power, N or SMK Connectors Conduction Cooled



dc to 6.0 GHz
400 Watts
 RoHS



Features

- /// Precision Connectors with high temperature support beads.
- /// Designed to meet environmental requirements of MIL-DTL-3933.
- /// 10 Kilowatts peak, Conduction Cooled
- /// Wireless Applications - Optimized for use in the communications bands.

Specifications

NOMINAL IMPEDANCE: 50 Ω
FREQUENCY RANGE: dc to 6.0 GHz

MAXIMUM DEVIATION OVER FREQUENCY:

| Nominal ATTN (dB) | Deviation (dB) |
|-------------------|----------------|
| 10, 20, 30, 40 | ± 1.25 |

MAXIMUM SWR:

| Frequency (GHz) | SWR |
|-----------------|------|
| dc - 2.5 | 1.10 |
| 2.5 - 6 | 1.20 |

3rd ORDER INTERMODULATION (258-XX-XX-LIM ONLY): Reflected Levels (IM3), -100 & Through Levels (IM3), -110 dBc with two input signals @ 869 MHz and 891 MHz with average carrier power levels of +43 dBm each.

POWER RATING: 400 watts average (unidirectional) to 10 kilowatt peak (5 μsec pulse width; 2% duty cycle) with case temperature held within **100 °C maximum** with appropriate conductive heat sink. Maximum power rating into output port is 40 watts average.

TEMPERATURE COEFFICIENT: <0.0004 dB/dB/°C

TEMPERATURE RANGE: -55 to 100°C (case temperature)

TEST DATA: Swept data plots of attenuation and SWR from 50 MHz to 6 GHz.

CONNECTORS: Type N connectors per MIL-STD-348 interface dimensions - mate nondestructively with MIL-C-39012 connectors. SMK (2.92mm) connectors mate with SMA, 3.5mm and other 2.92mm connectors.

| Options | Description | Options | Description |
|---------|-------------|---------|---------------|
| 1 | SMK Female | 3 | Type N Female |
| 2 | SMK Male | 4 | Type N Male |

CONSTRUCTION: Aluminum alloy body, stainless steel connectors; gold plated beryllium copper contacts.

WEIGHT: 700 g (24.6 oz.) maximum

PHYSICAL DIMENSIONS:

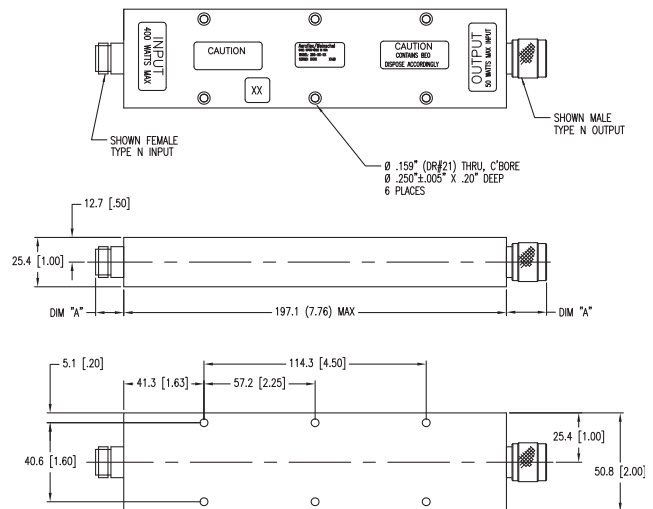

| Connector | DIM A | Connector | DIM A |
|-----------|-------------|---------------|-------------|
| N Male | 22.9 (0.90) | 2.92mm Male | 14.0 (0.55) |
| N Female | 15.0 (0.59) | 2.92mm Female | 12.7 (0.50) |

NOTE: All dimensions are given in mm (inches) and are maximum, unless otherwise specified.

MODEL NUMBER DESCRIPTION:

Example:

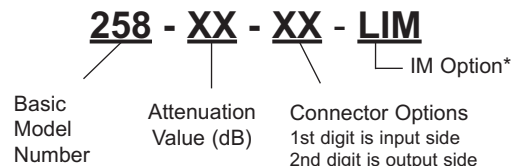

* Add -LIM for Low Intermodulation option.



Certificate No. 289j

AEROFLEX / WEINSCHEL

5305 Spectrum Drive
Frederick, MD 21703-7362
Tel: 800-638-2048, 301-846-9222
Fax: 301-846-9116
www.aeroflex-weinschel.com
weinschel-sales@aeroflex.com



Our passion for performance is defined by three attributes represented by these three icons: solution-minded, performance-driven and customer-focused.

Copyright 2012, Aeroflex / Weinschel, Inc. All rights reserved.

MRC Components GmbH & Co. KG, Bahnhofstraße 1, D-85354 Freising
Tel. +49-8161-9848-0, Fax +49-8161-9848-20
e-mail: info@mrccomponents.de web: www.mrccomponents.de

